

PHILIPS

D460
D465

Philips cordless phone

Philips cordless
phone with answering
machine



Extended user documentation

Register your product and get support at
www.philips.com/support

Contents

1	Important safety instructions	3
2	Your phone	4
	What is in the box	4
	Overview of the phone	5
	Overview of the base station	6
3	Get started	8
	Connect the base station	8
	Install the supplied batteries	9
	Configure your phone (country dependent)	10
	Change the remote access PIN code (for D465)	10
	Charge the handset	11
	Check the battery level	11
	What is standby mode?	11
	Display icons	12
	Check the signal strength	12
	Switch the handset on or off	13
4	Calls	14
	Make a call	14
	Answer a call	14
	End a call	15
	Adjust the earpiece/speaker volume	15
	Mute the microphone	15
	Turn the speaker on or off	15
	Make a second call	15
	Answer a second call	15
	Switch between two calls	15
	Make a conference call with the external callers	16
5	Intercom and conference calls	17
	Make a call to another handset	17
	Make a conference call	17
6	Text and numbers	19
	Enter text and numbers	19
	Switch between uppercase and lowercase	19
7	Phonebook	20
	View the phonebook	20
	Search a record	20
	Call from the phonebook	20
	Access the phonebook during a call	21
	Add a record	21
	Edit a record	21
	Delete a record	21
	Delete all records	22
8	Call log	23
	Call list type	23
	View the call records	23
	Save a call record to the phonebook	24
	Return a call	24
	Delete a call record	24
	Delete all call records	24
	Mark all call records as read records	24
9	Redial list	25
	View the redial records	25
	Save a redial record to the phonebook	25
	Redial a call	25
	Access the redial list during a call	25
	Delete a redial record	25
	Delete all redial records	25

10 Sound settings	26	14 Privacy mode	37
Set the handset's ringtone volume	26	Call barring (block outgoing calls)	37
Set the handset's ringtone for internal calls	26	Block incoming calls	37
Set the handset's ringtone for external calls	26	Silent mode	38
Set the key tone	26	Change the privacy mode PIN/passcord	39
Set the docking tone	26		
Set the battery tone	26	15 Services	40
Set the sound profile	27	Call list type	40
		Auto conference	40
11 Phone settings	28	Network type	40
Set the contrast of the display	28	Auto prefix	40
Eco mode	28	Select the recall duration	41
ECO+ mode	28	Dial mode	41
Name the handset	29	Auto clock	42
Set the date and time	29	Register the handset or additional handsets	42
Set the display language	29	Unregister handsets	43
Auto answer	29	Restore default settings	43
Activate/Deactivate auto hang up	29		
		16 Technical data	44
12 Alarm clock	30		
Set the alarm	30	17 Notice	45
Turn off the alarm	30	Declaration of conformity	45
		Use GAP standard compliance	45
13 Telephone answering machine	31	Compliance with EMF	45
Turn the answering machine on or off	31	Disposal of your old product and battery	45
Family notes	31		
Set the answering machine language	31	18 Frequently asked questions	47
Announcements	32		
Incoming messages	33	19 Appendix	50
Call screening	34	Text and number input tables	50
Set the ring delay	34		
Remote access	34		

1 Important safety instructions

Power requirements

- This product requires an electrical supply of 100–240 volts AC. In case of power failure, the communication can be lost.
- The voltage on the network is classified as TNV-3 (Telecommunication Network Voltages), as defined in the standard EN 60950.



Warning

- The Electrical network is classified as hazardous. The only way to power down the charger is to unplug the power supply from the electrical outlet. Ensure that the electrical outlet is always easily accessible.

To avoid damage or malfunction



Caution

- Use only the power supply listed in the user instructions.
- Use only the batteries listed in the user instructions.
- Risk of explosion if battery is replaced by an incorrect type.
- Dispose of used batteries according to the instructions.
- Do not dispose of batteries in fire.
- Always use the cables provided with the product.
- Do not allow the charging contacts or the battery to come into contact with metal objects.
- Do not let small metal objects come into contact with the product. This can deteriorate audio quality and damage the product.
- Metallic objects may be retained if placed near or on the handset receiver.

- Do not use the product in places where there are explosive hazards.
- Do not open the handset, base station or charger as you could be exposed to high voltages.
- For pluggable equipment, the socket-outlet shall be installed near the equipment and shall be easily accessible.
- Handsfree activation could suddenly increase the volume in the earpiece to a very high level: make sure the handset is not too close to your ear.
- This equipment is not designed to make emergency calls when the power fails. An alternative has to be made available to allow emergency calls.
- Do not allow the product to come into contact with liquids.
- Do not use any cleaning agents containing alcohol, ammonia, benzene, or abrasives as these may harm the set.
- Do not expose the phone to excessive heat caused by heating equipment or direct sunlight.
- Do not drop your phone or allow objects to fall on your phone.
- Active mobile phones in the vicinity may cause interference.

About operating and storage temperatures

- Operate in a place where temperature is always between 0°C to +40°C (up to 90% relative humidity).
- Store in a place where temperature is always between -20°C and +45°C (up to 95% relative humidity).
- Battery life may be shorter in low temperature conditions.

2 Your phone

Congratulations on your purchase and welcome to Philips!
To fully benefit from the support that Philips offers, register your product at www.philips.com/welcome.

What is in the box



Handset**

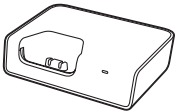

Base station (D460)



Base station (D465)

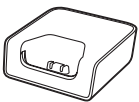

Charger**



Power adapter**

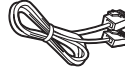

Line cord*

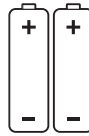

2 x AAA rechargeable batteries**



Guarantee



Short user manual

Note

- * In some countries, you have to connect the line adapter to the line cord, then plug the line cord to the telephone socket.
- ** In multi-handset packs, there are additional handsets, chargers, power adapters and batteries.

Overview of the phone

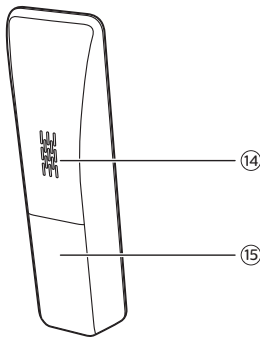
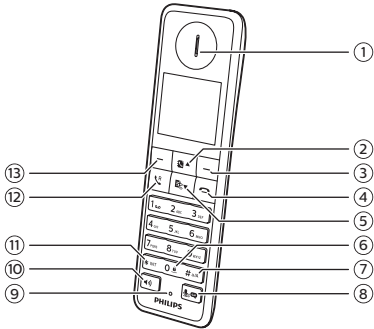

① Earpiece

② 

- Scroll up on the menu.
- Increase the earpiece/speaker volume.
- Access the phonebook in standby mode.

③ 

- Press to delete individual text or digit. Press and hold to remove all text.
- Cancel operation.
- Access the redial list in standby mode.
- Change the sound profile during a call.
- Select the function displayed on the handset screen directly above the key.

④ 

- End the call.
- Exit the menu/operation.
- Press and hold to power on/off the handset.

⑤  ▼

- Scroll down on the menu.
- Decrease the earpiece/speaker volume.
- Access the call log in standby mode.

⑥ 

- Press to enter a space during text editing.
- Press and hold to lock/unlock the keypad in standby mode.

⑦  #*/A

- Press and hold to enter a pause when when making a call.
- Switch to upper/lower case during editing.

⑧  (for D460) or  /  (for D465)

- Mute or unmute the microphone.
- Access to the answer machine menu in standby mode (for D465 only).
- Listen to new messages from the answering machine (for D465 only).



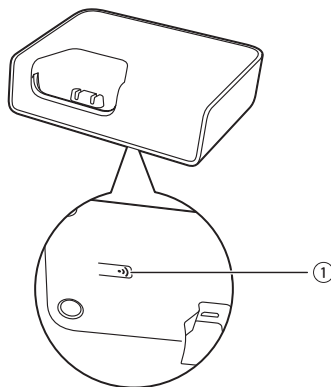

⑨ Microphone

Overview of the base station

D460



- ① 
- Press to find handsets.
 - Press and hold to enter the registration mode.

- ⑩ 
- Turn the speaker phone on/off.
 - Make and receive calls through the speaker.
- ⑪  *INT
- Set the dial mode (pulse mode or temporary tone mode). This function is country dependent.
 - Press and hold to switch between the intercom call and external call.
 - Press and hold to make an intercom call (for multi-handset version only).
- ⑫  R
- Make and receive calls.
 - Recall key (This function is network dependent.)
- ⑬ 
- Access the main menu in standby mode.
 - Press and hold to access the main menu when there is a new missed call/new message/new voice mail.
 - Confirm selection.
 - Enter the options menu
 - Select the function displayed on the handset screen directly above the key.
- ⑭ Loudspeaker
- ⑮ Battery door

D465

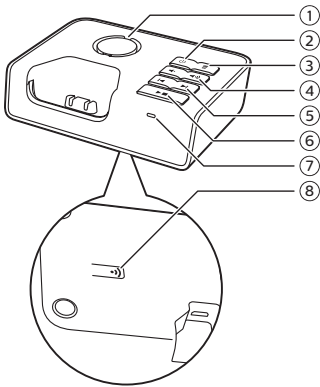

① Speaker

②  Turn the answering machine on or off.

③ 

- Delete the current playback message.
- Press and hold to delete all old messages.

④  Decrease/increase the speaker volume.

⑤  Skip backward/forward during playback.

⑥ 

- Play messages.
- Stop messages playback.

⑦ LED indicator

- Off: answering machine is off.
- On: answering machine is on.
- Flashing normally: incoming call(s), new message(s), listening to message(s),

recording message(s), operating answering machine.

- Flashing quickly: memory full, registration mode.

⑧ 

- Press to find handsets.
- Press and hold to enter the registration mode.

3 Get started

! Caution

- Make sure that you have read the safety instructions in the 'Important safety instructions' section before you connect and install your handset.

Connect the base station

! Warning

- Risk of product damage! Ensure that the power supply voltage corresponds to the voltage printed on the back or the underside of the phone.
- Use only the supplied power adapter to charge the batteries.

☰ Note

- If you subscribe to the digital subscriber line (DSL) high speed internet service through your telephone line, ensure you install a DSL filter between the telephone line cord and the power socket. The filter prevents noise and caller ID problems caused by the DSL interference. For more information on the DSL filters, contact your DSL service provider.
- The type plate is located on the bottom of the base station.

- 1 Connect each end of the power adapter to:
 - the micro USB socket at the bottom of the base station;
 - the power socket on the wall.
- 2 Connect each end of the line cord to:
 - the telephone socket at the bottom of the base station;
 - the telephone socket on the wall.

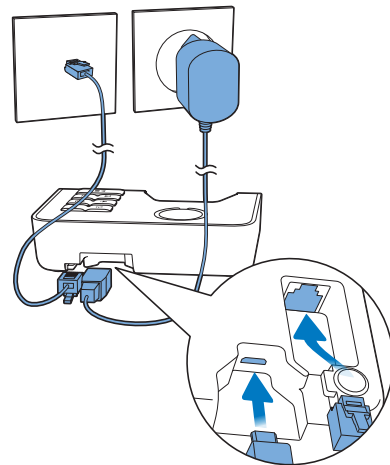

- 3 Connect each end of the power adapter to (for multi-handset version only):
 - the micro USB socket at the bottom of the extra handset charger.
 - the power socket on the wall.

The base station is equipped with a micro-USB socket. It allows connection to a power bank as an alternative source of power during AC power outage.

Note

- For the minimum requirement of the power bank, see the chapter “Technical Data”.
- While using a power bank as an alternative power source, it may drain very soon if you charge the handset at the same time.

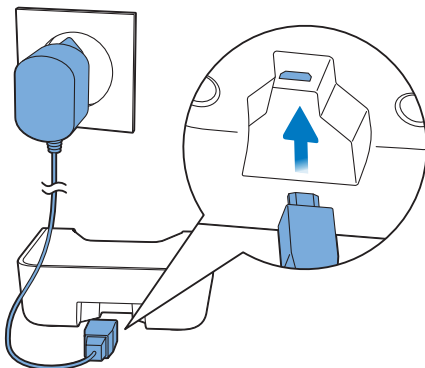

Install the supplied batteries

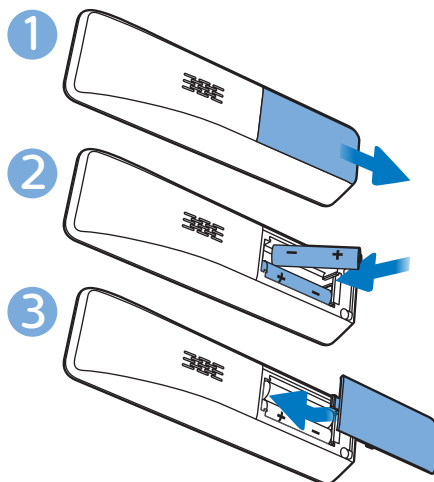

Caution

- Risk of explosion! Keep batteries away from heat, sunshine or fire. Never discard batteries in fire.
- Use only the supplied batteries.
- Risk of decreased battery life! Never mix different brands or types of batteries.

Note

- Charge the batteries for 8 hours before first use.
- If the handset becomes warm when the batteries are being charged, it is normal.

Warning

- When replacing the batteries, check the battery polarity. Incorrect polarity may damage the product.

Configure your phone (country dependent)

- 1 When using your phone for the first time, you see a welcome message.
- 2 Press [OK].

Set the country/language

Select your country/language, then press [OK] to confirm.

- ↳ The country/language setting is saved.



Note

- The country/language setting option is country dependent. If no welcome message is displayed, it means the country/language setting is preset for your country. Then you can set the date and time.

To reset the language, see the following steps.

- 1 Select [Phone setup] > [Language], then press [OK] to confirm.
- 2 Select a language, then press [OK] to confirm.
 - ↳ The setting is saved.

Set the date and time

- 1 Select [Menu] > [Phone setup] > [Date & time], then press [OK] to confirm.
- 2 Press the numeric buttons to enter the date, then press [OK] to confirm.
 - ↳ The time setting menu is displayed on the handset.
- 3 Press the numeric buttons to enter the time.
 - If the time is in 12-hour format, press ▲ / ▼ to select [am] or [pm] (Country dependent).
- 4 Press [OK] to confirm.

Change the remote access PIN code (for D465)



Note

- This feature is available only for models with answering machine.
- The default answering machine remote access PIN code is 0000 and it is important to change it to ensure the security.

- 1 Press / or [Menu] > [Answer machine] > [Remote access] > [Change PIN], then press [OK] to confirm.
- 2 Enter the old PIN, then press [OK] to confirm.
- 3 Enter the new PIN code, then press [OK] to confirm.
- 4 Enter the new PIN code again, then press [Save] to confirm.
 - ↳ The setting is saved.

Charge the handset

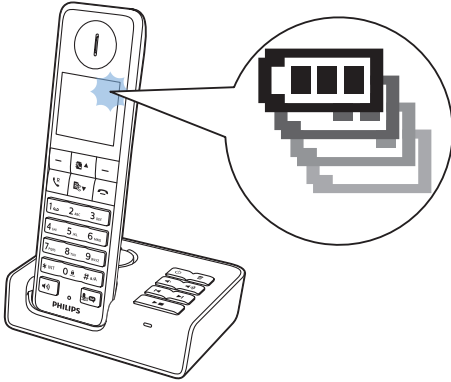

Place the handset on the base station to charge the handset. When the handset is placed correctly on the base station, you hear a docking tone.

↳ The handset starts charging.

Note

- Charge the batteries for 8 hours before first use.
- If the handset becomes warm when the batteries are being charged, it is normal.
- Over time, capacity of batteries decreases. This is a normal battery behavior.

Your phone is now ready to use.

Check the battery level

The battery icon displays the current battery level.



When the handset is off the base station, the bars indicate the battery level (full, medium and low). When the handset is on the base station/charger, the bars flash until charging is complete.



The empty battery icon flashes. The battery is low and needs recharging.













If you are on the phone, you hear warning tones when the batteries are almost empty. The call gets disconnected after the warning.









What is standby mode?

Your phone is in standby mode when it is idle. The handset name, date and time, and handset number are displayed on the handset screen. When the handset is on the base station, the clock screensaver will be displayed after a while if there is no event like missed calls or voice message.



Display icons

In standby mode, the icons shown on the main screen tell you what features are available on your handset.

Icon	Descriptions
	When the handset is off the base station/charger, the bars indicate the battery level (from full to low). When the handset is on the base station/charger, the bars keep scrolling until charging is complete.
	
	
	The empty battery icon flashes and you hear an alert tone. The battery is low and needs recharging.
	It shows the connection status between the handset and base station. The more bars are shown, the better the signal strength is.
	
	
	
	It remains steadily on when browsing incoming calls in the call log.
	It remains steadily on when browsing outgoing calls in the redial list.
	It flashes when there is a new missed call or when browsing unread missed calls in call log. It remains steady on when browsing the read missed calls in call log.
	It remains steadily on when browsing blocked calls in call log.
	It flashes when receiving incoming call. It remains steadily on when you are in a call.

	The speaker is on.
	The ringer is off. The silent mode is set and within active period (the phone does not ring).
	Answering machine (D465 only): it flashes when there is a new message or when the memory is full. It is displayed when the telephone answering machine is turned on.
	Press and hold 1.. to access the network voice mail (network and country dependent). It flashes when there is a new voice message. It remains steadily on when the voice messages are already viewed in the call log. The icon is not shown when there is no voice message.
	The silent mode is set, but is outside of active period.
	The alarm is activated.
	It is displayed when you adjust the volume.
	The Eco mode is activated.
	The ECO+ mode is activated.

Check the signal strength

	The number of bars indicates the connection status between the handset and base station. The more bars are shown, the better the connection is.
	
	

- Make sure the handset is connected to the base station before you make or receive calls and carry out the phone functions and features.
- If you hear warning tones when you are on the phone, the handset is almost out of battery or the handset is out of range. Charge the battery or move the handset nearer to the base station.



Note

- When ECO+ is on, the signal strength is not displayed.

Switch the handset on or off

Press and hold  to switch the handset on or off.

4 Calls

Note

- When the power fails, the phone cannot access emergency services.

Tip

- Check the signal strength before you make a call or when you are in a call (see 'Check the signal strength' on page 12).



Make a call

You can make a call in these ways:



- Normal call.
- Redial call.

You can also make a call from the redial list (see 'Redial a call' on page 25), phonebook list (see 'Call from the phonebook' on page 20) and call log (see 'Return a call' on page 24).

Normal call

- 1 Press  or .
- 2 Dial the phone number.
 - ↳ The number is dialed out.
 - ↳ The duration of your current call is displayed.

Redial call



- 1 Dial the phone number
 - To erase a digit, press [Clear].
 - To enter a pause, press and hold #0/A.
- 2 Press  or  to dial out the call.

Note

- The talk time of your current call is displayed on the call timer.
- If you hear warning tones, the phone is almost out of battery or out of range. Charge the battery or move the phone close to the base station.

Answer a call

When the phone rings, you can select from the following options:

- press  or  to answer the call.
- pick up the phone to answer the call when you activate the auto answer feature (see 'Auto answer' on page 29).
- select [Silent] to temporarily turn off the ringer of the current incoming call.

Warning

- When the handset rings or when the handsfree is activated, keep the handset away from your ear to avoid ear damage.

Note

- The caller ID service is available if you have registered to the caller ID service with your service provider.

Tip

- When there is a missed call, a notification message appears.

End a call

You can end a call in these ways:

- Press  ;
- Place the handset to the base station or charging cradle.

Note



- Placing the handset to the base station or charging cradle does not end the call when the auto hangup feature is turned off (see 'Activate/Deactivate auto hang up' on page 29).

Adjust the earpiece/speaker volume

Press  /  to adjust the volume during a call.

- ↳ The earpiece/speaker volume is adjusted and the phone is back to the call screen.

Mute the microphone

- 1 Press  during a call.
 - ↳ The handset displays [Mute on].
 - ↳ The caller cannot hear you, but you can still hear his voice.
- 2 Press  again to unmute the microphone.
 - ↳ You can now communicate with the caller.

Turn the speaker on or off

Press  on the handset.

Make a second call

Note

- This service is network dependent.





- 1 Press  during a call.
 - ↳ The first call is put on hold.
- 2 Dial the second number.
 - ↳ The number displayed on the screen is dialed out.

Answer a second call

Note

- This service is network dependent.

When there is a periodical beep to notify you of an incoming call, you can answer the call in these ways:

- 1 Press  and  to answer the call.
 - ↳ The first call is put on hold, and you are now connected to the second call.
- 2 Press  and  to end the current call and answer the first call.

Switch between two calls

Note

- This service is network dependent. Check with your network provider for operation.

Press  and .

- ↳ The current call is put on hold, and you are now connected to the other.

Make a conference call with the external callers



Note

- This service is network and country dependent. Check with the service provider for operation and additional charges.

When you are connected to two calls, press , then .

- ↳ The two calls are combined and a conference call is established.

5 Intercom and conference calls

Note



- This feature is available for multi- handset versions only.

An intercom call is a call to another handset that shares the same base station. A conference call involves a conversation between you, another handset user and the outside callers.

Make a call to another handset

Note

- If the base station only has 2 registered handsets, press and hold *INT to make a call to another handset.

- 1 Press and hold *INT.
 - ↳ The handsets available for intercom are displayed.
- 2 Select a handset, then press [OK] to confirm.
 - ↳ The selected handset rings.
- 3 Press  on the selected handset.
 - ↳ The intercom is established.
- 4 Press [Cancel] or  to cancel or end the intercom call.

Note

- If the selected handset is busy, [Busy] is displayed on the handset screen.

While you are on the phone

You can go from one handset to another during a call:

- 1 Press and hold *INT.
 - ↳ The current caller is put on hold.
 - ↳ For multi-handset versions, the handsets available for intercom are displayed, then go to step 2.
- 2 Select a handset, then press [OK] to confirm.
 - ↳ Wait for the other side to answer your call.

Switch between calls

Press *INT to switch between the outside call and the intercom call.

Make a conference call

A 3-way conference call is between you, another handset user and the outside callers. It requires two handsets to share the same base station.

During an external call

- 1 Press and hold *INT to initiate an internal call.
 - ↳ The external caller is put on hold.
 - ↳ For multi-handset versions, The handsets available for

intercom are displayed. Then go to step 2.

- ↳ For two-handset versions, the other handset rings. Then go to step 3.

2 Select a handset, then press [OK] to confirm.

- ↳ The selected handset rings.

3 Press  on the selected handset.

- ↳ The intercom is established.

4 Press [Conf].

- ↳ You are now in a 3-way conference call with an external call and a selected handset.

5 Press  to end the conference call.



Note

- Press  to join an ongoing conference with another handset if [Services] > [Conference] is set to [Auto].

During the conference call

1 Press [Int.] to put the external call on hold and go back to the internal call.

- ↳ The external call is put on hold.

2 Press [Conf] to establish the conference call again.





Note

- If a handset hangs up during the conference call, the other handset remains connected to the external call.

6 Text and numbers

You can enter text and numbers for handset name, phonebook records, and other menu items.

Enter text and numbers

- 1 Press once or several times on the alphanumeric key to enter the selected character.
- 2 Press [Clear] to delete a character. Press and hold [Clear] to delete all characters. Press ▲ / ▼ to move the cursor left and right.
- 3 Press 0_A to add a space.



Note

- For information on key mapping of characters and numbers, see the chapter 'Appendix'.

Switch between uppercase and lowercase

By default, the first letter of each word in a sentence is uppercase and the rest is lowercase. Press and hold #*A to switch between the uppercase and lowercase letters.

7 Phonebook

This phone has a phonebook that stores up to 50 records. You can access the phonebook from the handset. Each record can have a name up to 16 characters long. It can store up to 3 numbers, with each number up to 24 digits long.

You have up to 2 direct access memories (Keys 1 and 2). Depending on your country, keys 1 and 2 are preset to the voice mail number and information service number of your service provider respectively. When you press and hold on the key in standby mode, the saved phone number is dialed automatically.

Note

- The availability of direct access memory is country dependent.

View the phonebook

Note

- You can view the phonebook on one handset only each time.

- 1 Press ▲ or select [Menu] > [Phonebook] > [View] > [OK] to access the phonebook list.
- 2 Select a contact and view the available information.

Search a record

You can search the phonebook records in these ways:

- Scroll the contacts list.
- Enter the first character of the contact.

Scroll the contact list

- 1 Press ▲ or select [Menu] > [Phonebook] > [View] > [OK] to access the phonebook list.
- 2 Press ▲ and ▼ to scroll through the phonebook list.

Enter the first character of a contact

- 1 Press ▲ or select [Menu] > [Phonebook] > [View] > [OK] to access the phonebook list.
- 2 Press the alphanumerical key that matches the character.
↳ The first record that starts with this character is displayed.

Call from the phonebook

- 1 Press ▲ or select [Menu] > [Phonebook] > [View] > [OK] to access the phonebook list.
- 2 Select a contact in the phonebook list.
- 3 Press [View].
- 4 Select a type of number (home/mobile/office), press to make the call.

Access the phonebook during a call

- 1 Press [Option] and select [Phonebook].
- 2 Press [OK] to confirm.
- 3 Select a contact, then press [OK] to view the number.





Add a record

Note

- If your phonebook memory is full, a notification message is displayed on the handset. Delete some records to add new ones.
- When you change the number of a record, the new number will overwrite the old number.

- 1 Select [Menu] > [Phonebook] > [Add new], then press [OK] to confirm.
- 2 Enter the name, then press [OK] to confirm.
- 3 Enter the home number, mobile number and office number, then press [Save] to confirm.
↳ Your new record is saved.

Tip

- Press and hold #*#* to insert a pause.
- Press once or several times on the alphanumeric key to enter the selected character.
- Press [Clear] to delete the character. Press   /   to move the cursor left and right.

Note

- You can save 3 numbers at maximum per each phonebook entry.

Edit a record

- 1 Select [Menu] > [Phonebook] > [Edit], then press [OK] to confirm.
- 2 Select a contact, then press [OK] to confirm.
- 3 Edit the name, then press [OK] to confirm.
- 4 Select the home/mobile/office number, then press [OK] to confirm.
- 5 Edit the number, then press [Save] to confirm.

Delete a record

- 1 Select [Menu] > [Phonebook] > [Delete], then press [OK] to confirm.
- 2 Select a contact, then press [OK] to confirm.
↳ A confirmation request is displayed on the handset.
- 3 Press [OK] to confirm.
↳ The record is deleted.

Delete all records

- 1 Select [Menu] > [Phonebook] > [Delete all], press [OK] to confirm.
 - ↳ A confirmation request is displayed on the handset.
- 2 Press [OK] to confirm.
 - ↳ All records (except the 2 direct access memory records) are deleted.

8 Call log

The call log stores the incoming call history of all missed, received or blocked calls. The incoming call history includes the name and number of the caller, call time and date.



This feature is available if you have registered to the caller ID service with your service provider.

Your phone can store up to 50 incoming call records. The call log icon on the handset flashes to remind you of any unanswered calls. If the caller allows the display of his identity, you can view his name or number. The call records are displayed in chronological order with the most recent received call at the top of the list.

Note

- Make sure that the number in the call list is valid before you can call back directly from the call list.

The icons shown on the screen tell you whether they are missed/received/blocked calls.

Icons	Description
	It remains steadily on when browsing answered incoming calls in the call log.
	It flashes when there is a new missed call or when browsing unread missed calls in call log. It remains steady on when browsing the read missed calls in call log..
	It remains steadily on when browsing blocked calls in call log.

Call list type

You can set if you can see all incoming calls or only missed calls from the call log.



Note

- This is a country dependent feature.

Select the call list type

- 1 Select [Menu] > [Services] > [Call list type], then press [OK] to confirm.
- 2 Select an option, then press [OK] to confirm.



View the call records

- 1 Press  .
↳ The incoming call log is displayed.
- 2 Select a record, then press [Option].
- 3 Select [View] > [OK] for more available information.

Save a call record to the phonebook

- 1 Press  ▼.
↳ The incoming call log is displayed.
- 2 Select a record, then press [Option].
- 3 Select [Save number], then press [OK] to confirm.
- 4 Enter and edit the name, then press [OK] to confirm.
- 5 Select a type of number (home/mobile/office), then press [OK] to confirm.
- 6 Edit the number, then press [Save] to confirm.
↳ The record is saved.

Return a call

- 1 Press  ▼.
- 2 Select a record on the list.
- 3 Press  to make the call.

Delete a call record

- 1 Press  ▼.
↳ The incoming call log is displayed.
- 2 Select a record, then press [Option].
- 3 Select [Delete], then press [OK] to confirm.
↳ A confirmation request is displayed on the handset.
- 4 Press [OK] to confirm.
↳ The record is deleted.

Delete all call records

- 1 Press  ▼.
↳ The incoming call log is displayed.
- 2 Press [Option] to enter the options menu.
- 3 Select [Delete all], then press [OK] to confirm.
↳ A confirmation request is displayed on the handset.
- 4 Press [OK] to confirm.
↳ All records are deleted.

Mark all call records as read records

- 1 Press  ▼.
↳ The incoming call log is displayed.
- 2 Press [Option] to enter the options menu.
- 3 Select [Mark as read], then press [OK] to confirm.
↳ A confirmation request is displayed on the handset.
- 4 Press [OK] to confirm.
↳ All call records become read records.



Note

- When you select to mark all call records as read records, you will no longer get the notification of received but unread call records.

9 Redial list

The redial list stores the call history of dialed calls. It includes the names and/or numbers you have called. This phone can store up to 20 redial records.

View the redial records

Select [Redial].

Save a redial record to the phonebook

- 1 Press [Redial] to enter the list of dialed calls.
- 2 Select a record, then press [OK] > [Option] to confirm.
- 3 Select [Save number], then press [OK] to confirm.
- 4 Enter and edit the name, then press [OK] to confirm.
- 5 Select a type of number (home/mobile/office), then press [OK] to confirm.
- 6 Edit the number, then press [Save] to confirm.
↳ The record is saved.

Redial a call

- 1 Press [Redial].
- 2 Select the record you want to call. Press .
↳ The number is dialed out.

Access the redial list during a call

- 1 Press [Option] and select [Redial].
- 2 Press [OK] to confirm.

Delete a redial record

- 1 Press [Redial] to enter the list of dialed calls.
- 2 Select a record, then press [OK] > [Option] to confirm.
- 3 Select [Delete], then press [OK] to confirm.
↳ A confirmation request is displayed on the handset.
- 4 Press [OK] to confirm.
↳ The record is deleted.

Delete all redial records

- 1 Press [Redial] to enter the list of dialed calls.
- 2 Select [OK] > [Option] > [Delete all], then press [OK] to confirm.
↳ A confirmation request is displayed on the handset.
- 3 Press [OK] to confirm.
↳ All records are deleted.

10 Sound settings

Set the handset's ringtone volume

You can select among 5 ringtone volume levels or [Off].

- 1 Select [Menu] > [Sounds] > [Ring volume], then press [OK] to confirm.
- 2 Select a volume level, then press [OK] to confirm.
↳ The setting is saved.

Set the handset's ringtone for internal calls

You can select from 10 ringtones.

- 1 Select [Menu] > [Sounds] > [Ringtone int.], then press [OK] to confirm.
- 2 Select a ringtone, then press [OK] to confirm.
↳ The setting is saved.

Set the handset's ringtone for external calls

You can select from 10 ringtones.

- 1 Select [Menu] > [Sounds] > [Ringtone ext.], then press [OK] to confirm.
- 2 Select a ringtone, then press [OK] to confirm.
↳ The setting is saved.

Set the key tone

Key tone is the sound made when you press a key on the handset.

- 1 Select [Menu] > [Sounds] > [Key tone], then press [OK] to confirm.
- 2 Select [On]/[Off], then press [OK] to confirm.
↳ The setting is saved.

Set the docking tone

Docking tone is the sound made when you place the handset on the base station or charger.

- 1 Select [Menu] > [Sounds] > [Docking tone], then press [OK] to confirm.
- 2 Select [On]/[Off], then press [OK] to confirm.
↳ The setting is saved.

Set the battery tone

Battery tone is the sound made when the battery is low and needs recharging.

- 1 Select [Menu] > [Sounds] > [Battery tone], then press [OK] to confirm.
- 2 Select [On]/[Off], then press [OK] to confirm.
↳ The setting is saved.

Set the sound profile

You can set the sound in the earpiece among 3 different profiles.

- 1 Select [Menu] > [Sounds] > [MySound], then press [OK] to confirm.
- 2 Select a profile, then press [OK] to confirm.
↳ The setting is saved.

Access the sound profile during a call

Press [Sound] for once or several times to change the sound profile during a call.

11 Phone settings

You can customize the settings to make it your own phone.

Set the contrast of the display

You can set the contract of the handset screen to different levels.

- 1 Select [Menu] > [Phone setup] > [LCD contrast], then press [OK] to confirm.
- 2 Select an option, then press [OK] to confirm.

Eco mode

The Eco mode reduces the transmission power of the handset and base station when you are on a call or when the phone is in standby mode.

- 1 Select [Menu] > [Phone setup] > [Eco mode], then press [OK] to confirm.
- 2 Select [On]/[Off], and press [OK] to confirm.
 - ↳ The setting is saved.
 - ↳ ECO is displayed in standby mode.

Note

- When ECO mode is set to [On], the connection range between the handset and the base station can be reduced.

ECO+ mode

When the ECO+ mode is activated, it eliminates the radiation of the handset and base station in standby mode.

- 1 Select [Menu] > [Phone setup] > [ECO+ mode], then press [OK] to confirm.
- 2 Select [On]/[Off], and press [OK] to confirm.
 - ↳ The setting is saved.
 - ↳ ECO+ is displayed in standby mode after a while.

Note

- Make sure that all the handsets registered to the base station are D460/D465 in order to have the ECO+ feature functioning properly.
- When ECO+ is activated, the standby time is reduced. This is because in ECO+ mode the base station is not transmitting any signal in standby mode; therefore the handset needs to "listen" more frequently for signals from the base station to detect incoming calls or other requests from the base station. The time it takes for the handset to access features like call setup, call log, paging, and phonebook browsing is also delayed. The handset will not alert you to link loss in case of power loss or moving out of range.

The following table shows you the current status of the handset screen with different Eco mode and ECO+ mode settings.

Eco mode	ECO+ mode	Handset icon display
[Off]	[Off]	ECO and ECO+ are off.
[Off]	[On]	ECO+ is displayed only after the ECO+ mode is activated during standby mode .
[On]	[Off]	ECO is displayed.

[On] [On] **ECO** is displayed and changed to **ECO+** when the **ECO+** mode is activated in standby mode.

Name the handset

The name of the handset can be up to 14 characters. It is displayed on the handset screen in standby mode.

- 1 Select [Menu] > [Phone setup] > [Phone name], then press [OK] to confirm.
- 2 Enter or edit the name. To erase a character, press [Clear].
- 3 Press [OK] to confirm.
↳ The setting is saved.

Set the date and time

For information, see 'Set the date and time (see 'Set the date and time' on page 10)'.



Set the display language

Note

- This feature only applies to models with multiple-language support.
- Languages available vary from country to country.

- 1 Select [Menu] > [Phone setup] > [Language], then press [OK] to confirm.
- 2 Select a language, then press [OK] to confirm.
↳ The setting is saved.

Auto answer

When you activate the auto answer feature, you can connect to the incoming call automatically once you pick up the handset. When you deactivate this feature, you have to press  or  to answer the incoming call.

- 1 Select [Menu] > [Phone setup] > [Auto answer], then select [OK] to confirm.
- 2 Select [On]/[Off], and select [OK] to confirm.
↳ The setting is saved.

Activate/Deactivate auto hang up

You can activate the auto hang up function so that you can end a call by simply placing the handset on the base station or charge cradle.

- 1 Select [Menu] > [Phone setup] > [Auto hang-up], then press [OK] to confirm.
- 2 Select [On]/[Off], then press [OK] to confirm.
↳ The setting is saved.

Note

- When auto hang up is deactivated, you can put the handset to the base station or charging cradle and continue with your call through the speaker.

12 Alarm clock

Your phone has a built-in alarm clock. Check the information below to set your alarm clock.

Set the alarm

- 1 Select [Menu] > [Alarm], then press [OK] to confirm.
- 2 Select [On once] or [On daily], then press [OK] to confirm.
- 3 Enter an alarm time, then press [OK] to confirm.
- 4 Select [Alarm tone], then press [OK].
- 5 Select a tone from options, then press [OK] to confirm.
 - ↳ The alarm is set and  is displayed on the screen.



Tip

- Press  /  to switch between [am]/[pm] (Country dependent).

Turn off the alarm

When the alarm rings

- Press [Off] to turn off the alarm.

Before the alarm rings

Select [Menu] > [Alarm] > [Off], then press [OK] to confirm.

- ↳ The setting is saved.

13 Telephone answering machine

Note

- Available only for D465.

Your phone includes a telephone answering machine that records unanswered calls when it is on. By default, the answering machine is set to the [Answer & rec.] mode. You can access the answering machine remotely and change the settings through the answering machine menu on the handset.

Turn the answering machine on or off

Through the base

Press **⏻** to turn the answering machine on or off in standby mode.

Through the handset

- 1 Press **📞** / **☎** or [Menu] > [Answer machine] > [OK].
- 2 Select [On/off] > [On]/[Off], then press [OK] to confirm.
- 3 After selecting [On], select between [Answer & rec.]/[Answer only], then press [OK] to confirm.
↳ The setting is saved.

Note

- [Answer only] means the answering machine is on. Calls are only answered, messages are not recorded.
- [Answer & rec.] means the answering machine is on. Calls are answered and messages are recorded.
- When the answering machine is switched on, it answers incoming calls after a certain number of rings based on the ring delay setting.

Family notes

You can leave your family an audio note in the answering machine.

- 1 Press **📞** / **☎** or [Menu] > [Answer machine] > [Family note], then press [OK] to confirm.
- 2 Start recording close to the microphone after the beep.
- 3 Press [OK] to stop recording and listen to the audio note.
- 4 Press [OK] to save the family note or [Delete] to remove it.

Set the answering machine language

Note

- This feature only applies to models with multiple-language support.

The answering machine language is the language for the announcements.



- 1 Press **📞** / **☎** or [Menu] > [Answer machine] > [Voice language], then press [OK] to confirm.
- 2 Select a language, then press [OK] to confirm.
↳ The setting is saved.

Announcements

The announcement is the message your caller hears when the answering machine picks up the call. The answering machine has 2 pre-recorded announcements: [Answer & rec.] and [Answer only].

Record an announcement



The maximum length of the announcement you can record is 3 minutes. The newly recorded announcement automatically replaces the old one.

- 1 Press  /  or [Menu] > [Answer machine] > [Announcement], then press [OK] to confirm.
- 2 Select [Answer & rec.] or [Answer only], then press [OK] to confirm.
- 3 Select [Record], then press [OK] to confirm.
- 4 Start recording close to the microphone after the beep.
- 5 Press [OK] to stop recording or the recording stops after 3 minutes.
↳ You can listen to the newly recorded announcement on the handset.

Note

- Make sure that you speak close to the microphone when you record an announcement.



Listen to the announcement

- 1 Press  /  or [Menu] > [Answer machine] > [Announcement], then press [OK] to confirm.
- 2 Select [Answer & rec.] or [Answer only], then press [OK] to confirm.
- 3 Select [Play], then press [OK] to confirm.
↳ You can listen to the current announcement.

Note

- You can no longer listen to the announcement when you pick up an incoming call.

Restore the default announcement

- 1 Press  /  or [Menu] > [Answer machine] > [Announcement], then press [OK] to confirm.
- 2 Select [Answer & rec.] or [Answer only], then press [OK] to confirm.
- 3 Select [Use default], then press [OK] to confirm.
↳ The default announcement is restored.

Note

- You can no longer listen to the announcement when you pick up an incoming call.

Incoming messages

Each message can be up to 3 minutes long. When you receive new

messages, the new message indicator on the answering machine flashes.

Note

- If you pick up the phone when the caller leaves a message, the recording stops and you can talk to the caller directly.
- If the memory is full, the answering machine switches to [Answer only] automatically. Delete old messages to record new ones.

Listen to the incoming message

You can listen to the incoming messages in the sequence they are recorded.

From the base

- To start/stop listening, press **▶■**.
- To adjust the volume, press **◀ / ▶**.
- To play the previous message/replay the current message, press **◀**.
- To play the next message, press **▶**.
- To delete the current message, press **🗑**.

Note

- No deleted messages can be recovered.

From the handset

- If there are new messages, Press **📞 / 📞** to listen. If there is no new message, press **📞 / 📞**, then [OK] to listen to old messages.
- Select [Menu] > [Answer machine] > [Play], then press [OK] to confirm.
 - ↳ New messages start playing.
 - Old messages start playing if there is no new message.
- Press [Back] to stop listening.
- Press **🔊▲ / 🔊▼** to increase/decrease the volume.
- Press [OK] to enter the options menu.

You can use the following functions with the shortcut keys .

Key	Function
1	Listen to the previous message.
2	Listen to messages.
3	Skip to the next message.
6	Delete the current message.
8	Stop listening to the message.

Delete an incoming message

From the base

Press **🗑** when you listen to the message.

- ↳ The current message is deleted.

From the handset

- 1 When you listen to the message, press [Option] to enter the options menu.
- 2 Select [Delete], then press [OK] to confirm.
 - ↳ The current message is deleted.

Delete all old incoming messages

From the base

Press and hold **🗑** in standby mode.

- ↳ All old messages are permanently deleted.

From the handset

- 1 Press **📞 / 📞** or [Menu] > [Answer machine] > [Delete all], then press [OK] to confirm.
 - ↳ A confirmation request is displayed on the handset.
- 2 Press [OK] to confirm.
 - ↳ All old messages are permanently deleted.



Note

- You can only delete the read messages. No deleted messages can be recovered.

Call screening

You can hear the caller while he is leaving a message.



From the base

- Press  /  on the answering machine to adjust the speaker volume during call screening.



Note

- If you turn the speaker to the lowest volume level, the call screening function is off.

Activate/Deactivate the call screening on the handset



Press  /  or [Menu] > [Answer machine] > [HS screening] > [On]/[Off], then press [OK] to confirm.

When the call screening function is activated, you can:

- press [Silent] to stop listening to the caller. Press [Screen] to listen to the caller again.
- press  ▲ /  ▼ to adjust the speaker volume during call screening.

Set the ring delay

You can set the number of times the phone rings before the answering machine picks up the call.

- 1 Press  /  or [Menu] > [Answer machine] > [Ring delay], then press [OK] to confirm.
- 2 Select a new setting, then press [OK] to confirm.
 - ↳ The setting is saved.

Note

- Make sure that the answering machine is switched on before this feature can be applied.

Tip

- When you access the answering machine remotely, you are recommended to set the ring delay to [Toll saver] mode. This is a cost effective way to manage your messages. When there are new messages, the answering machine picks up the call after 3 rings; When there is no messages, it picks up the call after 5 rings.

Remote access



You can operate your answering machine when you are away from home. Simply make a call to your phone with a touch tone phone and enter your 4-digit PIN code.

Note



- The remote access PIN code is the same as your system PIN. The preset PIN is 0000.

Activate/deactivate the remote access

You can allow or block remote access to the answering machine.

- 1 Press  /  or [Menu] > [Answer machine] > [Remote access], then press [OK] to confirm.
- 2 Select [Activate]/[Deactivate], then press [OK] to confirm.
↳ The setting is saved.

Change the PIN code

- 1 Press  /  or [Menu] > [Answer machine] > [Remote access] > [Change PIN], then press [OK] to confirm.
- 2 Enter the old PIN, then press [OK] to confirm.
- 3 Enter the new PIN code, then press [OK] to confirm.
- 4 Enter the new PIN code again, then press [Save] to confirm.
↳ The setting is saved.

Access the answering machine remotely

- 1 Make a call to your home number with a touch tone phone.
- 2 Enter # when you hear the announcement.
- 3 Enter your PIN code.
↳ You now have access to your answering machine, and you can now listen to the new messages.

Note

- You have 2 chances to enter the correct PIN code before your phone hangs up.

- 4 Press a key to carry out a function. See the Remote access commands table below for a list of available functions.

Note

- When there is no message, the phone hangs up automatically if no key is pressed for 8 seconds.
- When the answering machine is turned off but the remote access function is activated, the answering machine will still pick up the call in [Answer only] mode after 10 rings.

Remote access commands

Key	Function
1	Listen to the previous message.
2	Listen to messages.
3	Skip to the next message.
6	Delete the current message.
7	Switch the answering machine on (not available when you listen to the messages).
8	Stop listening to the message.
9	Switch the answering machine off. (not available when you listen to the messages).

Behavior of the LED indicator on the base station

The table below shows you the current status with different LED indicator behavior on the base station.

LED indicator	Message status
Steady on	You are in a call.
Flashing	<ul style="list-style-type: none">• There is a new message.• There is a new voice mail.• There is a missed call.
Flashing on and off	There is an incoming call.

14 Privacy mode

You can access the privacy mode menu to block outgoing and incoming calls.

Call barring (block outgoing calls)

You can block outgoing calls to numbers, such as overseas calls or undesirable hotlines by barring calls that start with certain digits. You can create 4 sets of numbers with 4 digits at maximum for each set of numbers. When you make a call that starts with one of these 4 sets of numbers, the outgoing call is then barred.

Activate/deactivate the call barring mode

- 1 Select [Menu] > [Privacy mode], then press [OK] to confirm.
- 2 Enter the privacy mode PIN/passcode. The default PIN/passcode is 0000. Then press [OK] to confirm.
- 3 Select [Call barring] > [Barring mode] > [On]/[Off], then press [OK] to confirm.
↳ The setting is saved.

Add new numbers to the call barring list

- 1 Select [Menu] > [Privacy mode], then press [OK] to confirm.
- 2 Enter the privacy mode PIN/passcode. The default PIN is 0000. Then press [OK] to confirm.
- 3 Select [Call barring] > [Barring number], then press [OK] to confirm.
- 4 Select a number from the list, then press [OK] to confirm.
- 5 Type or edit the number, then press [OK] to confirm.
↳ The setting is saved.

Block incoming calls

Note

- Make sure you have subscribed to the caller ID service before you use this feature.

There are two way to block incoming calls:

- block anonymous calls;
- create a blacklist.

Note

- When a call is blocked, the ringer is muted. The call is still displayed and logged.

Block anonymous calls

You can block calls whose identity is withheld by the caller (e.g. private

calls)..

- 1 Select [Menu] > [Privacy mode], then press [OK] to confirm.
- 2 Enter the privacy mode PIN/passcode. The default PIN is 0000. Then press [OK] to confirm.
- 3 Select [Call block] > [Anonymous call] > [On]/[Off], then press [OK] to confirm.
↳ The setting is saved.

Blacklist

You can put numbers into the blacklist to block incoming calls from certain undesirable numbers. You can create 4 sets of numbers with 24 digits at maximum for each set of numbers. When there is an incoming call with leading digits that match any one of these 4 sets of numbers, the ringer will be muted.

Example:

Block number = 0123

Incoming call number = 0123456789

The call is blocked.

Block number = 23456789

Incoming call number = 03123456789

The call is not blocked.

Note

- The contact's name in phonebook will not be displayed if this contact's number matches the record saved in the blacklist.

Activate/deactivate the blacklist

- 1 Select [Menu] > [Privacy mode], then press [OK] to confirm.
- 2 Enter the privacy mode PIN/passcode. The default PIN is 0000. Then press [OK] to confirm.
- 3 Select [Call block] > [Blacklist] > [Block mode] > [On]/[Off], then press [OK] to confirm.
↳ The setting is saved.

Create a blacklist

- 1 Select [Menu] > [Privacy mode], then press [OK] to confirm.
- 2 Enter the privacy mode PIN/passcode. The default PIN is 0000. Then press [OK] to confirm.
- 3 Select [Call block] > [Blacklist] > [Block number], then press [OK] to confirm.
- 4 Enter the number, then press [OK] to confirm.
↳ The setting is saved.

Silent mode



You can set your phone to silent mode and enable it for a specific duration when you do not want to be disturbed. When the silent mode is turned on, your phone does not ring and does not sound the key tone and docking tone.

Note

- When you press  to find your handset, or when you activate the alarm, your phone still sends alert even when the silent mode is activated.

- 1 Select [Menu] > [Privacy mode], then press [OK] to confirm.
- 2 Enter the privacy mode PIN/passcode.
- 3 Select [Silent mode] > [On]/[Off], then press [OK] to confirm.
↳ The setting is saved.
- 4 Follow the screen instruction to set the time duration, then press [OK] to confirm.
↳ The setting is saved.

Note

- When the silent mode is set to [On],  is displayed.  is displayed during the preset time for the silent mode.

Change the privacy mode PIN/passcode

- 1 Select [Menu] > [Privacy mode], then press [OK] to confirm.
- 2 Enter the old PIN/passcode. The default PIN is 0000. Then press [OK] to confirm.
- 3 Select [Change PIN], then press [OK] to confirm.
- 4 Enter the new PIN/passcode, then press [OK] to confirm.
- 5 Enter the new PIN/passcode again, then press [OK] to confirm.
↳ The setting is saved.

15 Services

The phone supports a number of features that help you handle and manage the calls.

Call list type

You can set if you can see all incoming calls or only missed calls from the call log.

Note

- This is a country dependent feature.

Select the call list type

- 1 Select [Menu] > [Services] > [Call list type], then press [OK] to confirm.
- 2 Select an option, then press [OK] to confirm.

Auto conference

To join an external call with another handset, press .

Note

- This feature is available only for multi-handset versions.

Activate/Deactivate auto conference

- 1 Select [Menu] > [Services] > [Conference], then press [OK] to confirm.
- 2 Select [Auto]/[Off], then press [OK] to confirm.
 - ↳ The setting is saved.

Network type

Note

- This is a country dependent feature. It only applies to models with network type support.

- 1 Select [Menu] > [Services] > [Network type], then press [OK].
- 2 Select a network type, then press [OK].
 - ↳ The setting is saved.

Tip

- Select [PSTN] if the phone is connected to a fixed line (e.g. at home).
- Select [PBX] if the phone is connected to a private telephone line (e.g. in the office).

Auto prefix

This feature checks and formats your outgoing call number before it is dialed out. The prefix number can replace the detect number you set in the menu. For example, you set 604 as the detect number and 1250 as the prefix. When you have dialed out a number such as 6043338888, your phone changes the number to 12503338888 when it dials out.

Note

- The maximum length of a detect number is 5 digits. The maximum length of an auto prefix number is 10 digits.
- This is a country dependent feature.

Set auto prefix

- 1 Select [Menu] > [Services] > [Auto prefix], then press [OK] to confirm.
- 2 Enter the detect number, then press [OK] to confirm.
- 3 Enter the prefix number, then press [OK] to confirm.
↳ The setting is saved.

Note

- This is a country dependent feature.
- To enter a pause, press and hold #0/A.
- If the prefix number is set and the detect number is left empty, the prefix number is added to all outgoing calls.
- The feature is unavailable if the dialed number starts with * and #.

Select the recall duration

Make sure that the recall time is set correctly before you can answer a second call. In normal case, the phone is already preset for the recall duration. You can select among 3 options: [Short], [Medium] and [Long]. The number of available options varies

with different countries. For details, consult your service provider.

- 1 Select [Menu] > [Services] > [Recall time], then press [OK] to confirm.
- 2 Select an option, then press [OK] to confirm.
↳ The setting is saved.

Dial mode

Note

- This feature is country dependent and only applies to models that support both tone and pulse dial.

Dial mode is the telephone signal used in your country. The phone supports tone (DTMF) and pulse (rotary) dial. Consult the service provider for detailed information.

Set the dial mode

- 1 Select [Menu] > [Services] > [Dial mode], then press [OK] to confirm.
- 2 Select a dial mode, then press [OK] to confirm.
↳ The setting is saved.

Note

- If your phone is in pulse dial mode, press *INT during a call for temporary tone mode. Digits entered for this call are then sent out as tone signals.

Auto clock

Note

- This service is country and network dependent.
- Make sure you have subscribed to the caller ID service before you use this feature.

It synchronizes the date and time on your phone with the public switched telephone network (PSTN) automatically. For the date to be synchronized, make sure the current year is set.

- 1 Select [Menu] > [Services] > [Auto clock], then press [OK] to confirm.
- 2 Select [On]/[Off] . Press [OK].
 - ↳ The setting is saved.

Register the handset or additional handsets

You can register additional handsets to the base station. The base station can register up to 4 handsets.

Auto registration

- 1 You can auto-register handsets of the same model as follows:
 - If the handset is in [Register your Handset] status, press [OK].
 - If the handset is in [Searching] and [Unavailable] status, press

[Menu] > [Services] > [Register] > [Auto] > [OK].

- 2 Place the unregistered handset on the base station.
 - ↳ The handset detects the base station and registers automatically.
 - ↳ Registration is complete in less than two minutes. The base station automatically assigns a handset number to the handset.

Manual registration/Pairing

- 1 You can also register your handsets manually as follows:
 - If the handset is in [Register your Handset] status, press [OK].
 - If the handset is in [Searching] and [Unavailable] status, press [Menu] > [Services] > [Register] > [Manual] > [OK].
- 2 Press and hold **(*)** on the base station for 10 seconds.
- 3 Enter the system PIN. Press [Clear] to make corrections. Then press [OK] to confirm the PIN.
 - ↳ Registration is complete in less than 2 minutes. The base station automatically assigns a handset number to the handset.

Note

- If the PIN is incorrect or no base is found within a certain period, your handset displays a notification message.
- If registration fails, unplug the power adapter from the base station and plug it back. Wait for 15 seconds, and then repeat the registration procedure.
- The preset PIN is 0000. No change can be made on it.
- The handset and the base station are GAP compliant, which means they guarantee the minimum functions: register a handset, take the line, make a call and receive a call. The advanced features may not be available if you use them with other makes.
- To register the handset to another GAP-compliant base station, follow the registration procedure of that base station.

Note

- A handset cannot unregister itself if it is the only handset registered to the base station.

Unregister handsets

If two or more handsets share the same base station, you can unregister the handset or other handsets.

- 1 Select [Menu] > [Services] > [Unregister], then press [OK] to confirm.
- 2 Enter the system PIN. (The preset PIN is 0000). Press [Clear] to remove the number.
- 3 Select [Other handsets], then select a handset to be unregistered. For pre-registered handset, select [This handset].
- 4 Press [OK] to confirm.
 - ↳ The handset is unregistered.

Tip

- The handset name is displayed beside the handset number in standby mode.

Restore default settings

You can reset your phone settings to the original factory settings.

- 1 Select [Menu] > [Services] > [Reset], then press [OK] to confirm.
 - ↳ A confirmation request is displayed on the handset.
- 2 Press [OK] to confirm.
 - ↳ All settings (except the phonebook and direct access keys information) are reset.

16 Technical data

- Base: 91 grams
29.2 x 108.9 x 77.9 mm (H x W x D)
- Charger: 43 grams
28 x 78 x 78 mm (H x W x D)

General specification and features

- Talk time: 16 hours
- Standby time: 250 hours
- Range indoor: 50 meters
- Range outdoor: 300 meters
- Phonebook list with 50 entries
- Redial list with 20 entries
- Call log with 50 entries
- Answering machine with 30 minutes recording time
- Caller identification standard support: FSK, DTMF

Battery

- Philips: 2 x AAA Ni-MH 1.2V 550 mAh rechargeable batteries

Power adapter

Base and charger

- SPPS: SSY050050-UK, input: 100-240 V~, 50/60 Hz 200 mA, output: 5 Vdc 500 mA

Alternative power source

- Power bank: output: 5Vdc, 500mA (minimum)

RF output power

- < 24 dBm

Frequency Band

- 1880 MHz ~ 1900 MHz

Power consumption

- Power consumption in idle mode: around 0.70W (D460); 0.75W (D465)

Weight and dimensions (D460)

- Handset: 118 grams
165 x 47.3 x 22.9 mm (H x W x D)
- Base: 70 grams
28 x 108.9 x 77.9 mm (H x W x D)
- Charger: 43 grams
28 x 78 x 78 mm (H x W x D)

Weight and dimensions (D465)

- Handset: 118 grams
165 x 47.3 x 22.9 mm (H x W x D)

17 Notice

Declaration of conformity

Hereby, Gibson Innovations declares that this product is in compliance with the essential requirements and other relevant provisions of Directive 2014/53/EU. You can find the Declaration of Conformity on www.p4c.philips.com.

Use GAP standard compliance

The GAP standard guarantees that all DECT™ GAP handsets and base stations comply with a minimum operating standard irrespective of their make. The handset and base station are GAP compliant, which means they guarantee the minimum functions: register a handset, take the line, make a call and receive a call. The advanced features may not be available if you use them with other makes. To register and use this handset with a GAP compliant base station of different make, first follow the procedure described in the manufacturer's instructions, then follow the procedure described in this manual for registering a handset. To register a handset from different make to the base station, put the base station in registration mode, then follow the procedure described in the handset manufacturer's instructions.

Compliance with EMF

This product complies with all applicable standards and regulations regarding exposure to electromagnetic fields.

Disposal of your old product and battery



Your product is designed and manufactured with high quality materials and components, which can be recycled and reused.



This symbol on a product means that the product is covered by European Directive 2012/19/EU.



This symbol means that the product contains batteries covered by European Directive 2013/56/EU which cannot be disposed of with normal household waste.

Inform yourself about the local separate collection system for electrical and electronic products and batteries. Follow local rules and never dispose of the product and batteries with normal household waste. Correct disposal of old products and batteries helps prevent negative consequences for the environment and human health.

Removing the disposable batteries

To remove the disposable batteries, see the chapter "Install the supplied batteries'."



When this logo is attached to a product, it means a financial contribution has been paid to the associated national recovery and recycling system.

Environmental information

All unnecessary packaging has been omitted. We have tried to make the packaging easy to separate into three materials: cardboard (box), polystyrene foam (buffer) and polyethylene (bags, protective foam sheet.)

Your system consists of materials which can be recycled and reused if disassembled by a specialized company. Please observe the local regulations regarding the disposal of packaging materials, exhausted batteries and old equipment.

18 Frequently asked questions

My handset displays [Searching] or [Unavailable], or [Register your Handset], what do I do??

- Make sure that the base station has power supply.
- The handset is out of range. Move it closer to the base station.
- The handset is not paired with the base. Register the handset to the base station.

Tip

- For further information, see 'Register the handset or additional handsets' on the Services section.

If I fail to pair (register) the handset or additional handsets to the base station, what do I do?

- Your base memory is full. Unregister the unused handsets and try again (see 'Unregister handsets' on page 43).
- If registration fails, unplug the power adapter from the base station and plug it back. Wait for 15 seconds, and then repeat the registration procedure (see 'Register the handset or additional handsets' on page 42).



The range is short. How can I improve it? The range is subject to environmental factors, like electrical devices or walls in between.

- Move the base station to another corner/room.
- Move the base station away from other electrical appliances nearby that could interfere with the range (like routers, TV, radio, etc.).
- Do not put the base station on a metallic desk or a metallic table top.
- Turn off the ECO mode.

I have chosen a wrong country in Welcome screen, what do I do?

Reset your phone settings to the original factory settings (see 'Restore default settings' on page 43).

I have chosen a wrong language which I cannot read, what do I do?

- 1 Press  to go back to the standby screen.
- 2 Press  to access the main menu screen.
- 3 One of the following texts appears on the screen:

Phone setup > Language

電話設定 > 語言

[إعداد الهاتف] < [العربية]

- 4 Select it to access the language options.
- 5 Select your own language.

The handset loses connection with the base or the sound interrupts during a call.

- The handset is nearly out of range. Move it closer to the base station.
- Check if the ECO mode is activated. Turn it off to increase the handset range and enjoy the optimal call conditions.
- Re-register the handset to the base station.

No dialing tone/no free line.

- Check your phone connections.
- The handset is out of range. Move it closer to the base station.
- The handset is in [searching] or [Unavailable] status. Register the handset to the base station.

No docking tone.

- The handset is not placed properly on the base station/charger.
- The charging contacts are dirty. Disconnect the power supply first and clean the contacts with a damp cloth.

[Voicemail] is displayed on the handset. What do I do?

You receive the [Voicemail] alert when you have new voice messages stored in your network. The voice mail service is managed by your service provider but not on the phone itself. Contact your service provider for the settings.

The handset on the charger does not charge or the battery discharges too fast.

- Make sure the batteries are inserted correctly.
- Make sure the handset is placed properly on the charger. If the docking tone is turned on, you can hear the docking tone when you place the handset on the charging cradle. The battery icon animates when charging.
- The charging contacts are dirty. Disconnect the power supply first and clean the contacts with a damp cloth.
- The battery is not fully recharged. Leave the handset on the charging cradle for at least 8 hours or until the battery icon on the handset stops scrolling and indicates full bar.
- The batteries are old or defective. Purchase and replace with new rechargeable batteries with the same specifications.

No display.

- Make sure the batteries are charged.
- Make sure there is power and the phone is connected.

Bad audio (crackles, echo, etc.).

- The handset is nearly out of range. Move it closer to the base station.
- The phone receives interference from the nearby electrical appliances. Move the base station away from them.
- The phone is at a location with thick walls. Move the base away from them.
- The phone receives interference from the DSL (digital subscriber line) connection. Install a DSL filter to prevent the noise. Contact your service provider for the DSL filter.

The handset does not ring.

- Make sure the handset ringtone is turned on.
- Make sure the handset is registered to the base station.

The caller ID does not display.

- The service is not activated. Check with your service provider.
- The caller's information is withheld or unavailable.



Note

- If the above solutions do not help, disconnect the power supply from both the handset and base station. Try again after 1 minute.

19 Appendix

Text and number input tables

Key	Upper case characters (for English/French/ German/ Italian/Turkish/Portuguese/ Spanish/Dutch/Danish/ Finnish/Norwegian/ Swedish/ Romanian/Polish/Czech/ Hungarian/Slovakian/Slovenian/ Croatian/Lithuanian/Estonian/ Latvian/Bulgarian)
0	Space . 0 , / ; " ' ! ; ? ; * + - % \ ^ ~
1	1 @ _ # = < > () & € £ \$ ¥ [] { } ¢ § ...
2	A B C 2 à â Æ Á Ā Ä Å Ą Ā Ć Ć Ć
3	D E F 3 è é ê ë ě Ę Δ Φ
4	G H I 4 ħ ģ Ĩ Ĵ Ŀ Γ
5	J K L 5 Λ
6	M N O 6 Ñ Ó Ô Õ Ö
7	P Q R S 7 ς ϛ Π Θ Σ
8	T U V 8 Û Ü Ū Ŭ Ů
9	W X Y Z 9 Ø Ω Ξ Ψ Ž

Key	Lower case characters (for English/French/ German/ Italian/Turkish/Portuguese/ Spanish/Dutch/Danish/Finnish/ Norwegian/Swedish)
0	Space . 0 , / ; " ' ! ; ? ; * + - % \ ^ ~
1	1 @ _ # = < > () & € £ \$ ¥ [] { } ¢ § ...
2	a b c 2 à â æ á ā ä å ą ā ċ ċ ċ
3	d e f 3 è é ê ë ě Ę Δ Φ
4	g h i 4 ħ ģ Ĩ Ĵ Ŀ Γ
5	j k l 5 Λ
6	m n o 6 ñ ó ô õ ö ò

7	p q r s 7 β ς ϛ Π Θ Σ
8	t u v 8 Û Ü Ū Ŭ Ů
9	w x y z 9 Ø Ω Ξ Ψ Ž

Key	Upper case characters (for Greek)
0	Space . 0 , / ; " ' ! ; ? ; * + - % \ ^ ~
1	1 @ _ # = < > () & € £ \$ ¥ [] { } ¢ § ...
2	A B Γ 2 A B C Æ Ä Å Ć
3	Δ E Z 3 D E F Ę
4	H Θ I 4 G H I
5	K Λ M 5 J K L
6	N Ξ O 6 M N O Ñ Ö
7	Π Ρ Σ 7 P Q R S β
8	T Υ Φ 8 T U V Ü
9	X Ψ Ω 9 W X Y Z Ø

Key	Lower case characters (for Greek)
0	Space . 0 , / ; " ' ! ; ? ; * + - % \ ^ ~
1	1 @ _ # = < > () & € £ \$ ¥ [] { } ¢ § ...
2	α β γ 2 a b c à æ ä å
3	δ ε ζ 3 d e f è é
4	η θ ι 4 g h i i
5	κ λ μ 5 j k l Λ
6	ν ξ ο 6 m n o ñ ö ò
7	π ρ σ ς 7 p q r s β
8	τ υ φ 8 t u v ü ù
9	χ ψ ω 9 w x y z ø

Key	Upper case characters (for Serbian)
0	Space . 0 , / ; " ' ! ; ? ; * + - % \ ^ ~
1	1 @ _ # = < > () & € £ \$ ¥ [] { } α § ...
2	A B C Ђ Ć Č 2 A B B Г
3	D E F J Đ 3 Δ E Ж 3 Δ Ф
4	G H I Љ 4 И Й К Л Г
5	J K L Њ 5 M H O П Л
6	M N O Ћ 6 P C T Y
7	P Q R S Ж Š 7 Ф X Ц Ч П Θ Σ Β
8	T U V 8 Ш Ц Њ Ы
9	W X Y Z Ž 9 Ђ Э Ю Я Ω Ξ Ψ

Key	Lower case characters (for Serbian)
0	Space . 0 , / ; " ' ! ; ? ; * + - % \ ^ ~
1	1 @ _ # = < > () & € £ \$ ¥ [] { } α § ...
2	a b c Ђ Ć Č 2 A B B Г
3	d e f J Đ 3 Δ E Ж 3
4	g h i Љ 4 И Й К Л
5	j k l Њ 5 M H O П
6	m n o Ћ 6 P C T Y
7	p q r s Ж Š 7 Ф X Ц Ч П Θ Σ Β
8	t u v Љ 8 Ш Ц Њ Ы
9	w x y z Ž 9 Ђ Э Ю Я Ω Ξ Ψ



2017 © Gibson Innovations Limited. All rights reserved.
This product has been manufactured by, and is sold
under the responsibility of Gibson Innovations Ltd., and
Gibson Innovations Ltd. is the warrantor in relation to
this product.
Philips and the Philips' Shield Emblem are registered
trademarks of Koninklijke Philips N.V.

UM_D460-465_05_EN_V1.0
WK1725

