

DVD VIDEO PLAYER

DVP3120

Thank you for choosing Philips.

Need help fast?

Read your User's Manual first for quick tips that make using your Philips product more enjoyable.

If you have read your instructions and still need assistance, you may access our online help at www.philips.com/support



PHILIPS

Important notes for users in the U.K.

Mains plug

This apparatus is fitted with an approved 13 Amp plug. To change a fuse in this type of plug proceed as follows:

1. Remove fuse cover and fuse.
2. Fix new fuse which should be a BS1362 5 Amp, A.S.T.A. or BSI approved type.
3. Refit the fuse cover.

If the fitted plug is not suitable for your jack outlets, it should be cut off and an appropriate plug fitted in its place.

If the mains plug contains a fuse, this should have a value of 5 Amp. If a plug without a fuse is used, the fuse at the distribution board should not be greater than 5 Amp.

Note: The severed plug must be disposed to avoid a possible shock hazard should it be inserted into a 13 Amp jack elsewhere.

How to connect a plug

The wires in the mains lead are coloured with the following code: blue = neutral (N), brown = live (L).

As these colours may not correspond with the colour markings identifying the terminals in your plug, proceed as follows:

- Connect the blue wire to the terminal marked N or coloured black.
- Connect the brown wire to the terminal marked L or coloured red.
- Do not connect either wire to the earth terminal in the plug, marked E (or e) or coloured green (or green and yellow).

Before replacing the plug cover, make certain that the cord grip is clamped over the sheath of the lead - not simply over the two wires.

Copyright in the U.K.

Recording and playback of material may require consent. See Copyright Act 1956 and The Performer's Protection Acts 1958 to 1972.

DK

Advarsel: Usynlig laserstråling ved åbning når sikkerhedsafbrydere er ude af funktion. Undgå udsættelse for stråling.

Bemærk: Netafbryderen er sekundært indkoblet og afbryder ikke strømmen fra nettet. Den indbyggede netdel er derfor tilsluttet til lysnettet så længe netstikket sidder i stikkontakten.

S

Klass 1 laserapparat

Varning! Om apparaten används på annat sätt än i denna bruksanvisning specificerats, kan användaren utsättas för osynlig laserstråling, som överskrider gränsen för laserklass 1.

Observera! Stömbrytaren är sekundärt kopplad och bryter inte strömmen från nätet. Den inbyggda nät delen är därför ansluten till elnätet så länge stickproppen sitter i vägguttaget.

SF

Luokan 1 laserlaitte

Varoitus! Laitteen käyttäminen muulla kuin tässä käyttöohjeessa mainitulla tavalla saattaa altistaa käyttäjän turvallisuusluokan 1 ylittävälle näkymättömälle lasersäteilylle. Oikeus muutoksiin varataan. Laitte ei saa olla alttiina tippu- ja roiskevedelle.

Huom. Toiminnanvalitsin on kytketty toisipuolelle, eikä se kytke laitetta irti sähköverkosta. Sisäänrakennettu verkko-osa on kytketty sähköverkkoon aina silloin, kun pistoke on pistorasiassa.

CAUTION

VISIBLE AND INVISIBLE LASER RADIATION WHEN OPEN. AVOID EXPOSURE TO BEAM.

ADVARSEL

SYNLIG OG USYNLIG LASERSTRÅLING VED ÅBNING UND GÅ UDSÆTTELSE FOR STRÅLING

WARNING

SYNLIG OCH OSYNLIG LASERSTRÅLNING NÅR DENNA DEL ÄR ÖPPNAD BETRakta EJ STRÅLEN

VARO!

AVATTAESSA OLET ALTTIINA NÄKYVÄLLE JA NÄKYMÄTTÖMÄLLE LASER SÄTEILYLLE. ÄLÄ KATSO SÄTEESEEN

VORSICHT

GEFAHR VON SICHTBARER UND UNSICHTBARER LASERSTRAHLUNG BEI GEÖFFNETEM GEHÄUSE.

ATTENTION

RAYONNEMENT LASER VISIBLE ET INVISIBLE EN CAS D'OUVERTURE EXPOSITION DANGEREUSE AU FAISCEAU

Disposal of your old product



Your product is designed and manufactured with high quality materials and components, which can be recycled and reused.

When this crossed-out wheeled bin symbol is attached to a product it means the product is covered by the European Directive 2002/96/EC. Please inform yourself about the local separate collection system for electrical and electronic products.

Please act according to your local rules and do not dispose of your old products with your normal household waste. The correct disposal of your old product will help prevent potential negative consequences for the environment and human health.

The apparatus shall not be exposed to dripping or splashing and that no objects filled with liquids, such as vases, shall be placed on apparatus.

Due to the inconsistency of disc formats provided by various disc manufacturers, your DVD system may require a playability enhancement or upgrade. As DVD technology advances, these enhancements will become common and will be easy to complete.
Go to www.philips.com/support for software upgrade.

This product incorporates copyright protection technology that is protected by method claims of certain U.S. patents and other intellectual property rights owned by Macrovision Corporation and other rights owners. Use of this copyright protection technology must be authorized by Macrovision Corporation, and is intended for home and other limited viewing uses only unless otherwise authorized by Macrovision Corporation. Reverse engineering or disassembly is prohibited.

'CONSUMERS SHOULD NOTE THAT NOT ALL HIGH DEFINITION TELEVISION SETS ARE FULLY COMPATIBLE WITH THIS PRODUCT AND MAY CAUSE ARTIFACTS TO BE DISPLAYED IN THE PICTURE. IN CASE OF 525 OR 625 PROGRESSIVE SCAN PICTURE PROBLEMS, IT IS RECOMMENDED THAT THE USER SWITCH THE CONNECTION TO THE 'STANDARD DEFINITION' OUTPUT. IF THERE ARE QUESTIONS REGARDING TV SET COMPATIBILITY WITH THIS MODEL 525p AND 625p DVD PLAYER, PLEASE CONTACT OUR CUSTOMER SERVICE CENTER.'

General Information

Environmental Information

All unnecessary packaging has been omitted. The packaging has been made easy to separate into two materials; cardboard (box) and polyethylene (bags, protective foam sheet).

Your DVD player consists of materials which can be recycled and reused if disassembled by a specialised company. Please observe the local regulations regarding the disposal of packaging materials, exhausted batteries and old equipment.

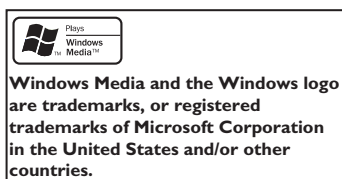
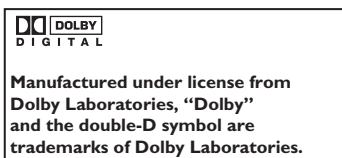

For Customer Use:
Read carefully the information located at the bottom or rear of your DVD Video player and enter below the Serial No. Retain this information for future reference.

Model No. DVP 3120
Serial No. _____

Laser Safety

This unit employs a laser. Due to possible eye injury, only a qualified service person should remove the cover or attempt to service this device.

NOTE:

Pictures shown maybe different between countries.

CAUTION:

WARNING LOCATION: ON THE BACKPLATE OF THE SET

NEVER MAKE OR CHANGE CONNECTIONS WITH THE POWER SWITCHED ON.

Specifications are subject to change without notice. Trademarks are the property of Koninklijke Philips Electronics N.V. or their respective owners.

This product complies with the radio interference requirements of the European Community.

CE This product complies with the requirements of the following directives and guidelines: 73/23/EEC + 89/336/EEC + 93/68/EEC

LASER

Type	Semiconductor laser InGaAlP (DVD) AlGaAs (CD)
Wave length	658 nm (DVD) 790 nm (CD)
Output Power	7.0 mW (DVD) 10.0 mW (VCD/CD)
Beam divergence	60 degrees

Language Code

Abkhazian	6566	Inupiaq	7375	Pushto	8083
Afar	6565	Irish	7165	Russian	8285
Afrikaans	6570	Íslenska	7383	Quechua	8185
Amharic	6577	Italiano	7384	Raeto-Romance	8277
Arabic	6582	Ivrit	7269	Romanian	8279
Armenian	7289	Japanese	7465	Rundi	8278
Assamese	6583	Javanese	7486	Samoan	8377
Avestan	6569	Kalaallisut	7576	Sango	8371
Aymara	6589	Kannada	7578	Sanskrit	8365
Azerhijani	6590	Kashmiri	7583	Sardinian	8367
Bahasa Melayu	7783	Kazakh	7575	Serbian	8382
Bashkir	6665	Kernewek	7587	Shona	8378
Belarusian	6669	Khmer	7577	Shqip	8381
Bengali	6678	Kinyarwanda	8287	Sindhi	8368
Bihari	6672	Kirghiz	7589	Sinhalese	8373
Bislama	6673	Komi	7586	Slovensky	8373
Bokmål, Norwegian	7866	Korean	7579	Slovenian	8376
Bosanski	6683	Kuanyama; Kwanyama	7574	Somali	8379
Brezhoneg	6682	Kurdish	7585	Sotho; Southern	8384
Bulgarian	6671	Lao	7679	South Ndebele	7882
Burmese	7789	Latina	7665	Sundanese	8385
Castellano, Español	6983	Latvian	7686	Suomi	7073
Catalán	6765	Letzeburgesch;	7666	Swahili	8387
Chamorro	6772	Limburgan; Limburger	7673	Swati	8383
Chechen	6769	Lingala	7678	Svenska	8386
Chewa; Chichewa; Nyanja	7889	Lithuanian	7684	Tagalog	8476
中文	9072	Luxembourgish;	7666	Tahitian	8489
Chuang; Zhuang	9065	Macedonian	7775	Tajik	8471
Church Slav; Slavonic	6785	Malagasy	7771	Tamil	8465
Chuvash	6786	Magyar	7285	Tatar	8484
Corsican	6779	Malayalam	7776	Telugu	8469
Česky	6783	Maltese	7784	Thai	8472
Dansk	6865	Manx	7186	Tibetan	6679
Deutsch	6869	Maori	7773	Tigrinya	8473
Dzongkha	6890	Marathi	7782	Tonga (Tonga Islands)	8479
English	6978	Marshallese	7772	Tsonga	8483
Esperanto	6979	Moldavian	7779	Tswana	8478
Estonian	6984	Mongolian	7778	Türkçe	8482
Euskara	6985	Nauru	7865	Turkmen	8475
Ελληνικά	6976	Navaho; Navajo	7886	Twi	8487
Faroese	7079	Ndebele, North	7868	Uighur	8571
Français	7082	Ndebele, South	7882	Ukrainian	8575
Frysk	7089	Ndonga	7871	Urdu	8582
Fijian	7074	Nederlands	7876	Uzbek	8590
Gaelic; Scottish Gaelic	7168	Nepali	7869	Vietnamese	8673
Gallegan	7176	Norsk	7879	Volapuk	8679
Georgian	7565	Northern Sami	8369	Walloon	8765
Gikuyu; Kikuyu	7573	North Ndebele	7868	Welsh	6789
Guarani	7178	Norwegian Nynorsk;	7878	Wolof	8779
Gujarati	7185	Occitan; Provençal	7967	Xhosa	8872
Hausa	7265	Old Bulgarian; Old Slavonic	6785	Yiddish	8973
Herero	7290	Oriya	7982	Yoruba	8979
Hindi	7273	Oromo	7977	Zulu	9085
Hiri Motu	7279	Ossetian; Ossetic	7983		
Hrvatski	6779	Pali	8073		
Ido	7379	Panjabi	8065		
Interlingua (International)	7365	Persian	7065		
Interlingue	7365	Polski	8076		
Inuktitut	7385	Português	8084		

Contents

Care and Safety Information	
Setup	8
Cleaning discs	8
General Information	
Accessories supplied	9
Region codes	9
Connections	
Connecting to television	10~12
Using SCART sockets	10
Using Composite Video sockets (CVBS)	10
Using Component Video sockets (YPbPr)	11
Using an accessory RF modulator	12
Connecting the power cord	13
Optional connections	
Connecting to a stereo system	14
Stereo system has right/left Audio In sockets	14
Connecting to a digital AV receiver	14
Receiver has a PCM, Dolby Digital or MPEG decoder	14
Product Overview	
Front and Rear panels	15
Remote Control	16
Getting Started	
Step 1: Inserting Batteries	17
Using the remote control to operate the system	17
Step 2: Finding your viewing channel	17
Step 3: Setting up Progressive Scan feature	18
Step 4: Selecting the matching colour system	19
Step 5: Setting the language	20
On-screen display (OSD) language	20
Audio, Subtitle and Disc menu languages	20
Playback from Disc	
Playable discs	21
Supported formats	21
Playback Features	
Starting disc playback	22
Basic playback controls	22
Pausing playback	22
Selecting title/chapter/track	22
Stopping playback	22
Operations for video playback	23
Using the Disc Menu	23
Zooming in	23
Slow Motion	23
Forward / Reverse Searching	23
Selecting various repeat functions	24
Repeat play mode	24
Repeating a section within a chapter/track	24
Viewing the disc playback information	25
Using the OSD menu	25

Contents

Special DVD Features	26
Playing a Title.....	26
Changing the Audio Language.....	26
Subtitles.....	26
Special VCD and SVCD Feature.....	26
Playback Control (PBC).....	26
Playing MP3/WMA/JPEG/Kodak Picture CD.....	27
General Operation	27
Playback selection	27
DVD Menu Options	
Using the General setup menu	28
OSD Language.....	28
Sleep.....	28
Using the Audio setup menu.....	29~30
Downmix	29
Digital Audio	29~30
Using the Video setup menu	30~32
TV Type.....	31
Setting the TV Display	31
Progressive	31
Sharpness.....	32
Brightness/Contrast/Color.....	32
Component.....	32
Using the Preference setup menu	33~34
Subtitle / Audio / Disc Menu	33
Parental	33-34
Changing the Password	34
Restoring to the original settings.....	34
Others	
Software Upgrade	35
Troubleshooting.....	36~37
Specifications	38
Glossary.....	39

Care and Safety Information

DANGER!

High voltage! Do not open the device. You run the risk of getting an electric shock.

The machine does not contain any user-serviceable parts. Please leave all maintenance work to qualified personnel.

Setup

Finding a suitable location

- Place the set on a flat, hard and stable surface. Do not place the set on a carpet.
- Do not put any equipment or heavy objects on top of the set.
- Do not position the set on top of other equipment that might heat it up (such as receiver or amplifier).
- Do not put anything under the set (such as CDs, magazines).
- Install this unit near the AC outlet and where the AC power plug can be reached easily.

Space for ventilation

- Place the apparatus in a location with adequate ventilation to prevent internal heat build up. Allow at least 10 cm (4.0") clearance from the rear and the top of the set and 5cm (2.0") from the left and right to prevent overheating.

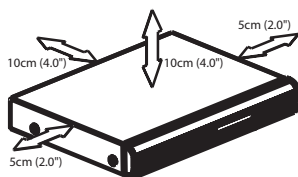

Avoid high temperatures, moisture, water and dust

- Apparatus shall not be exposed to dripping or splashing.
- Do not place any sources of danger on the apparatus (such as liquid filled objects, lighted candles).

Cleaning discs

Some problems occur because the disc inside the player is dirty (frozen picture, sound disruptions, picture distortions). To avoid these problems, discs should be cleaned on a regular basis.

To clean a disc, use a micro fibre cleaning cloth and wipe the disc from the center to the edge in a straight line.

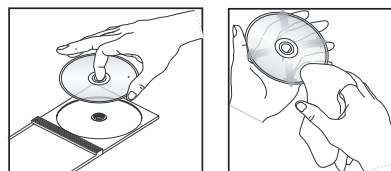

CAUTION!

Do not use solvents such as benzene, thinner, commercially available cleaners, or anti-static sprays intended for analog discs. Since the optical unit (laser) of the DVD player operates at a higher power than regular DVD or CD players, cleaning CDs intended for DVD or CD players may damage the optical unit (laser). Therefore, refrain from using a cleaning CD.

General Information

Accessories supplied

Remote control and two AAA batteries

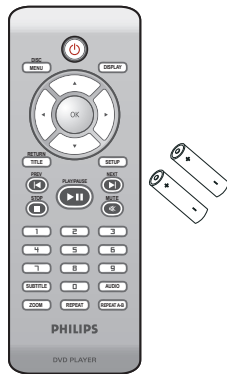













Region codes

This DVD player is designed to support the Region Management System. Check the regional code number on the disc package. If the number does not match the player's region number (see table below), the player may be unable to playback the disc.

Tips:

- It may not be possible to play CD-R/RW or DVD-R/RW in all cases due to the type of disc or condition of the recording.
- If you are having trouble playing a certain disc, remove the disc and try a different one. Improper formatted disc will not played on this DVD player.

Region	Discs that can be played
U.S.A. and Canada regions	 
U.K and Europe regions	 
Asia Pacific, Taiwan, Korea	 
Australia, New Zealand, Latin America	 
Russia and India regions	 
China, Calcos Islands, Walls and Futuna Islands	 

Connections

Connecting to television

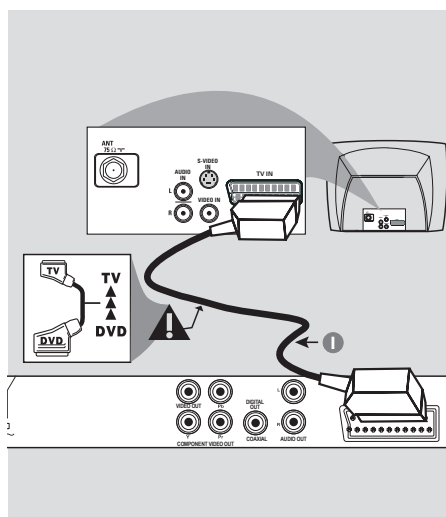

IMPORTANT!

- You only need to make one video connection from the following options, depending on the capabilities of your television.
- Connect the DVD player directly to the television.
- A SCART connection will let you use features both audio and video on the DVD player.

Using SCART sockets

- 1 Use the SCART cable to connect the DVD player's SCART socket (**TV OUT**) to the corresponding Scart input sockets on the TV (cable not supplied).

Tip:

- Ensure that the 'TV' indication on SCART cable is connected to the television and 'DVD' indication on SCART is connected to the DVD player.

TIPS: Before making or changing any connections, make sure that all the devices are disconnected from the power outlet.

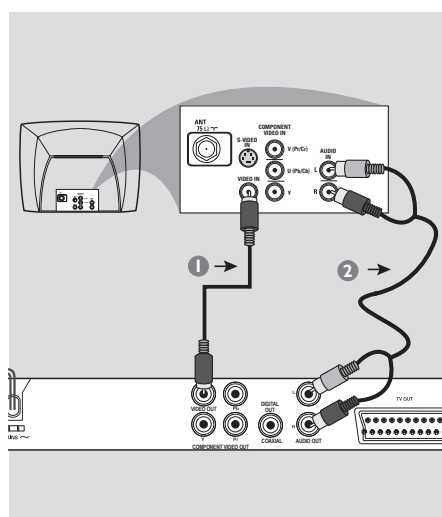

IMPORTANT!

- You only need to make one video connection from the following options, depending on the capabilities of your television.
- Connect the DVD player directly to the television.

Using Composite Video sockets (CVBS)

- 1 Use the composite video cable (yellow) to connect the DVD player's **VIDEO OUT** (CVBS) socket to the video input socket (or labeled as A/V In, Video In, Composite or Baseband) on the television (cable not supplied).
- 2 To hear sound of this DVD player through your television, use the audio cables (white/red) to connect **AUDIO OUT** (L/R) sockets of the DVD player to the corresponding **AUDIO IN** sockets on the television (cable not supplied).

Connections (continued)

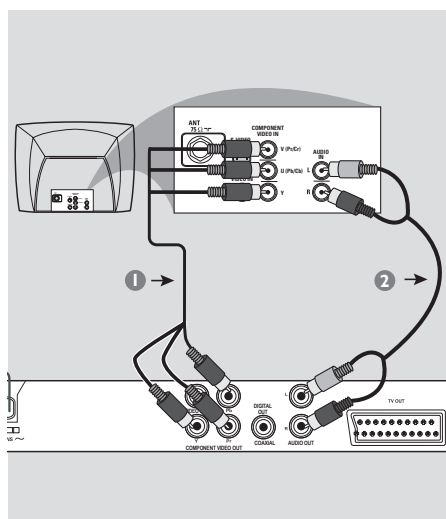

IMPORTANT!

– The progressive scan video quality is only possible when using YPbPr and a progressive scan television is required.

Using Component Video sockets (YPbPr)

- 1 Use the component video cables (red/blue/green) to connect the DVD player's YPbPr sockets to the component video input sockets (or labeled as YPbPr) on the television (cable not supplied).
- 2 To hear sound of this DVD player through your television, use the audio cables (white/red) to connect AUDIO OUT (L/R) sockets of the DVD player to the corresponding AUDIO IN sockets on the television (cable not supplied).
- 3 Proceed to page 18 for detailed progressive scan setup.

TIPS: Before making or changing any connections, make sure that all the devices are disconnected from the power outlet.

11

Connections (continued)

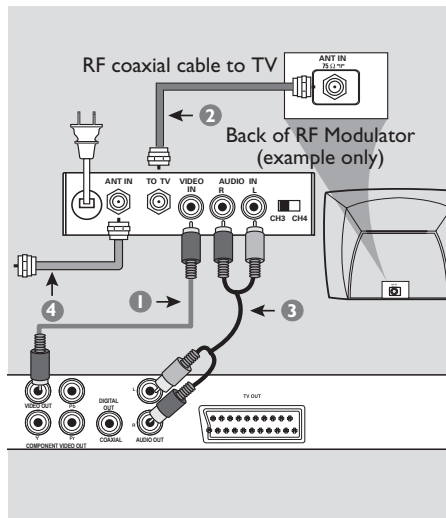

IMPORTANT!

– If your television only has a single Antenna In socket (or labeled as 75 ohm or RF In,) you will need an RF modulator in order to view the DVD playback on the television. See your electronics retailer or contact Philips for details on RF modulator availability and operations.

Using an accessory RF modulator

- 1 Use the composite video cable (yellow) to connect the DVD player's **VIDEO OUT** (CVBS) socket to the video input socket on the RF modulator.
- 2 Use the RF coaxial cable (not supplied) to connect ANTENNA OUT or TO TV socket on the RF modulator to the ANTENNA IN socket on the television.

- 3 To hear sound of this DVD player through your TV, use the audio cables (white/red) to connect AUDIO OUT (L/R) sockets of the DVD player to the corresponding AUDIO IN sockets on the RF modulator (cable not supplied).
- 4 Connect the Antenna or Cable TV service signal to the ANTENNA IN or RF IN socket on the RF modulator. (It may have been connected to your TV previously. Disconnect it from the TV).

TIPS: Before making or changing any connections, make sure that all the devices are disconnected from the power outlet.

Connections (continued)

Connecting the power cord

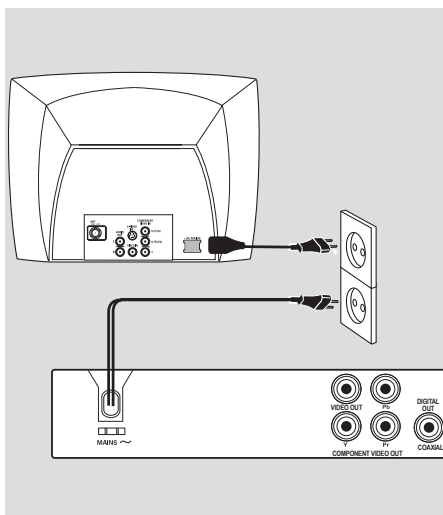

After everything is connected properly, plug in the AC power cord to the power outlet.

Never make or change any connections with the power switched on.

When no disc is loaded, **press STANDBY-ON on the DVD player front panel.**

“--” may appear on the display panel.

TIPS: Before making or changing any connections, make sure that all the devices are disconnected from the power outlet.

Optional connections

Connecting to a stereo system

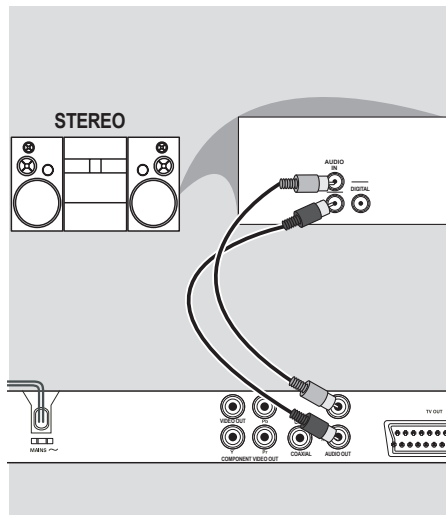

Stereo system has right/ left Audio In sockets

- 1 Select one of the video connections (CVBS VIDEO IN or COMPONENT VIDEO IN) depending on the options available on your television.
- 2 Use the audio cables (white/red) to connect AUDIO OUT (L/R) sockets of the DVD Player to the corresponding AUDIO IN sockets on the stereo system (cable not supplied).

Connecting to a digital AV receiver

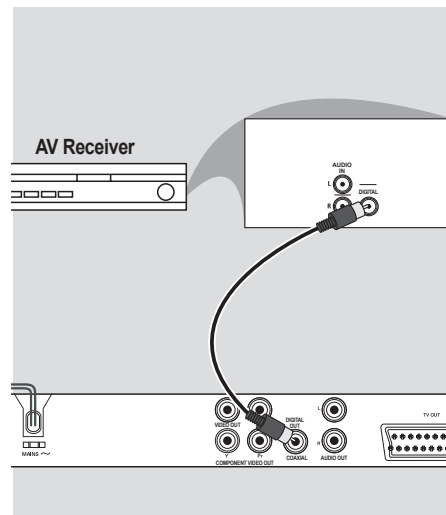

Receiver has a PCM, Dolby Digital or MPEG decoder

- 1 Select one of the video connections (CVBS VIDEO IN or COMPONENT VIDEO IN) depending on the options available on your television.
- 2 Connect the COAXIAL socket of the DVD player to the corresponding Digital Audio In socket on your receiver (cable not supplied).
- 3 Set the DVD player's digital output to PCM-Only or ALL depending on the capabilities of your receiver (see page 30 {Digital Output}).

Tip:

– If the audio format of the Digital Output does not match the capabilities of your receiver, the receiver will produce a strong, distorted sound or no sound at all.

TIPS: Before making or changing any connections, make sure that all the devices are disconnected from the power outlet.

Product Overview

Front and Rear Panels

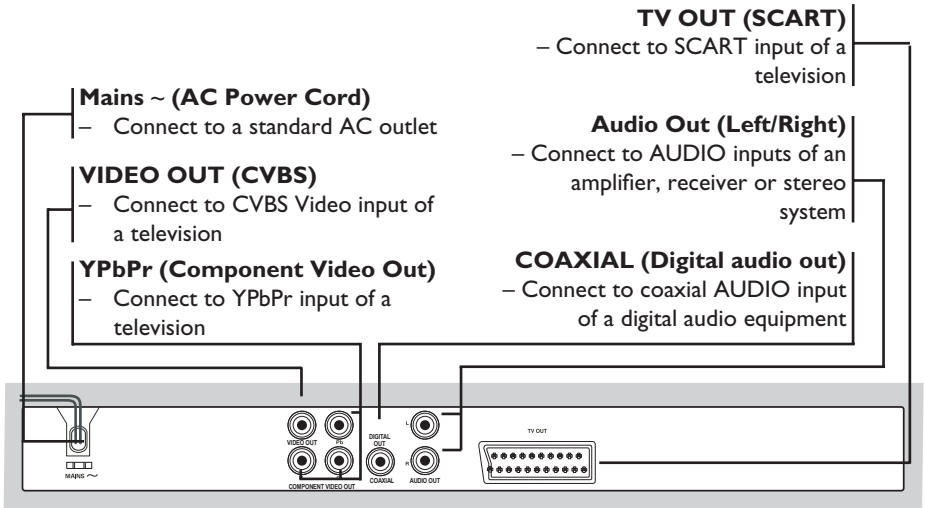
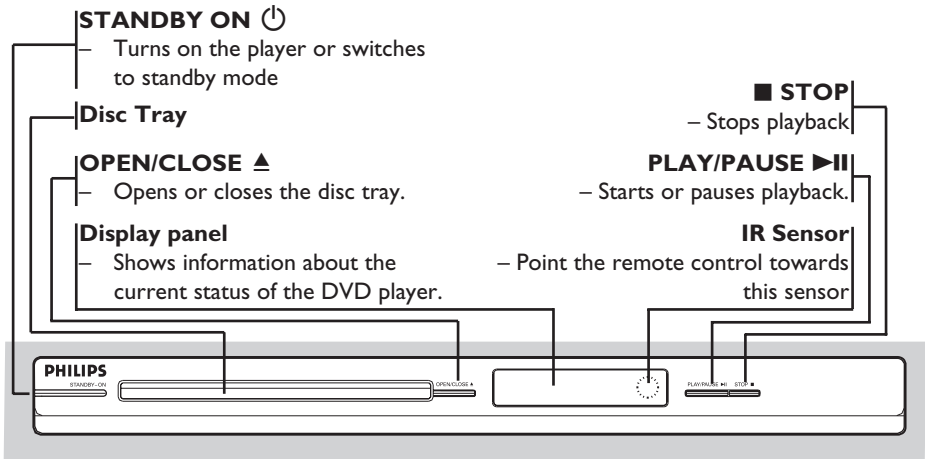

Product Overview (continued)

Remote Control

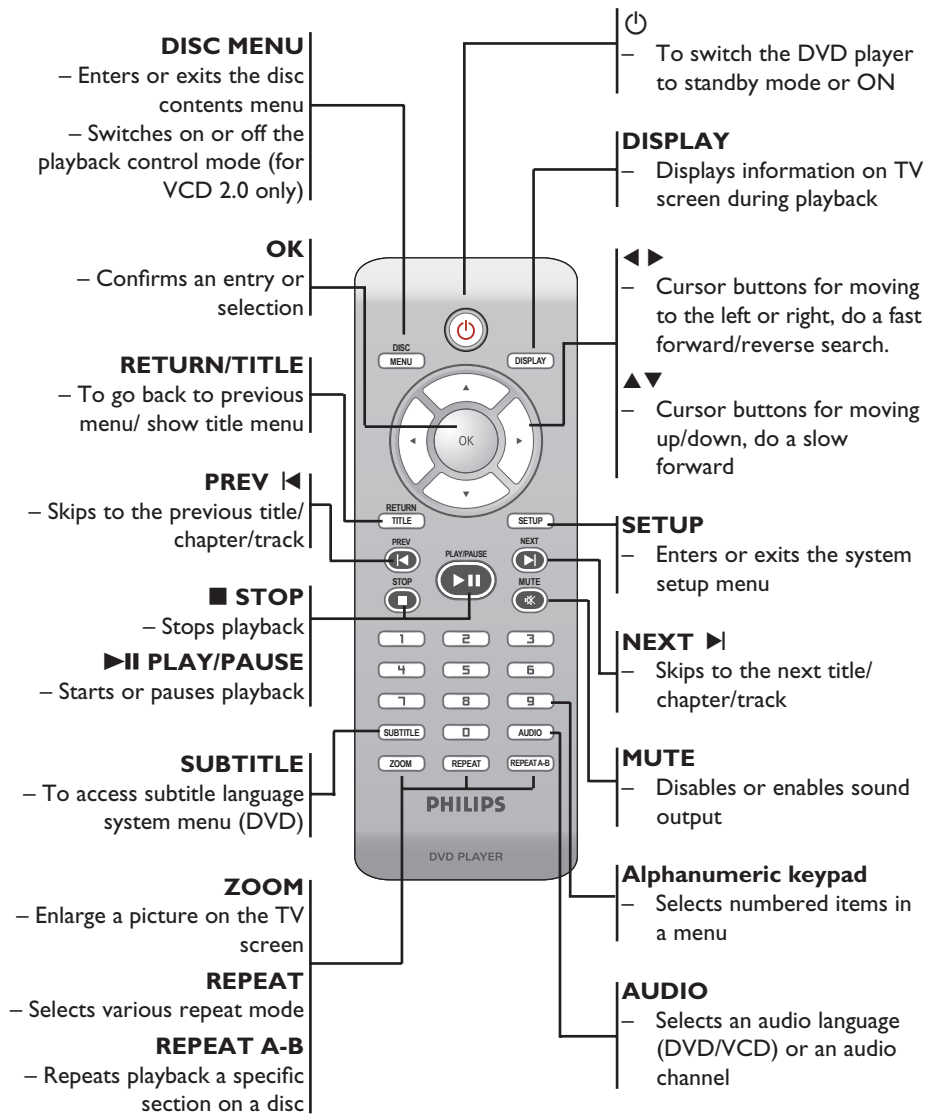

Getting Started

Step 1 : Inserting Batteries

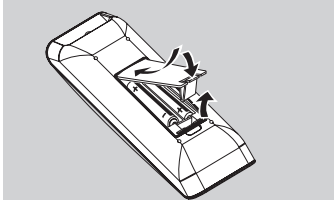

- 1 Open the battery compartment.
- 2 Insert two batteries type R03 or AAA, following the indications (+ -) inside the compartment.
- 3 Close the cover.

CAUTION!

- Remove batteries if they are exhausted or if the remote is not to be used for a long time.
- Do not use old and new or different types of batteries in combination.
- Batteries contain chemical substances, so they should be disposed of properly.

Using the remote control to operate the system

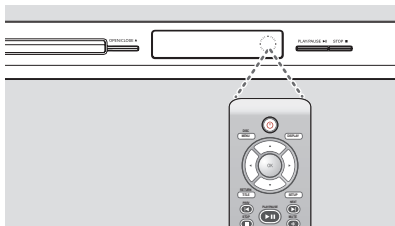

- 1 Aim the remote control directly at the remote sensor (IR) on the front panel.
- 2 Do not put any objects between the remote control and the DVD player while operating the DVD player.

Step 2 : Finding your viewing channel

- 1 Press **STANDBY-ON**  on the DVD player to turn it on.
- 2 Turn on the TV and set it to the correct video-in channel. You should see the blue DVD background screen.
 - Usually these channel are between the lowest and highest channels and may be called FRONT, A/V IN, VIDEO. See your TV's manual for more details.
 - Or, you may go to channel 1 on your TV, then press the Channel down button repeatedly until you see the Video In channel.
 - Or, the TV remote control may have a button or turn that chooses different video modes.
 - Or, set the TV to channel 3 or 4 if you are using an RF modulator.
- 3 If you are using external equipment, (such as audio system or receiver), turn it on and select the appropriate input source for the DVD player output. Refer to the equipment user's manual for detail.

Getting Started (continued)

Step 3 : Setting up Progressive Scan feature

(for Progressive Scan TV only)

The progressive scan displays twice the number of frames per seconds than interlaced scanning (ordinary normal TV system). With nearly double the number of lines, progressive scan offers higher picture resolution and quality.

Before you start...

- Ensure that you have connected this DVD player to a progressive scan TV using the YPbPr connection (see page 11).
- Ensure that you have completed the basic installation and setup.

- 1 Turn on your TV and set to interlace mode (refer to your TV user manual).
- 2 Press **STANDBY-ON** (⏻) on the remote control to turn on the DVD player.
- 3 Select the correct video-in channel.
→ The DVD background menu appears.
- 4 Press **SETUP**.
- 5 Press **▶** to select { **Video Setup Page** }.

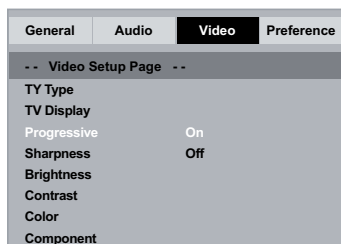

- 6 Select { **Component** } to { **Interlace** }, then **OK** to confirm.
- 7 Press **▲ ▼** repeatedly to select { **Progressive** }, then press **▶**.

- 8 Select { **On** }, then press **OK** to confirm.
→ The menu will appear on the TV.

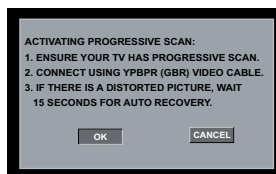

- 9 Press **◀** to highlight { **OK** } and press **OK** to confirm.
- 10 Turn on your TV progressive scan mode (refer to your TV user manual).
→ The menu will appear on the TV.

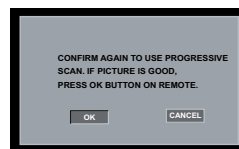

- 11 Press **◀** to highlight { **OK** } and press **OK** to confirm.
→ The setup is now completed and you can start enjoy the high quality picture.

To deactivate Progressive Scan manually:

- Wait for 15 seconds for the auto recovery.
- OR**
- 1 Press **OPEN/CLOSE** (⏻) on the DVD player to open the disc tray.
 - 2 Press **numeric keypad '1'** on the remote control for few seconds.
→ The DVD background screen appears.

Tip:

– There are some progressive scan TVs and High-Definition TVs that are not fully compatible with this unit, resulting in the unnatural picture when playing back a DVD VIDEO disc in the progressive scan mode. In such a case, turn off the progressive scan feature on both the DVD player and your TV.

TIPS: The underlined option is the factory default setting.
Press **◀** to go back to previous menu item. Press **SETUP** to exit the menu item.

Getting Started (continued)

Step 4 : Selecting the matching colour system

The colour system of the DVD player, disc and TV should match in order for the disc to play. Before changing the TV system, determine the colour system of your TV.

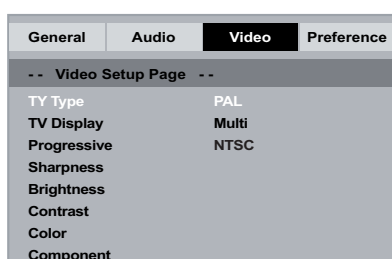

- 1 Press **SETUP**.
- 2 Press **▶** to select { **Video Setup Page** }.
- 3 Press **▲ ▼** repeatedly to select { **TV Type** }, then press **▶**.
- 4 Use **▲ ▼** to select one of the options below:

{ PAL }

Select this if the connected TV has the PAL colour system. It will change the video signal of an NTSC disc and output it to PAL format.

{ NTSC }

Select this if the connected TV has the NTSC colour system. It will change the video signal of a PAL disc and output it to NTSC format.

{ Multi }

Select this if the connected TV is compatible with both NTSC and PAL (multi-system). The output format will be in accordance with the video signal of the disc.

- 5 Select a setting and press **OK**.
→ Follow the instructions show on the TV to confirm the selection.

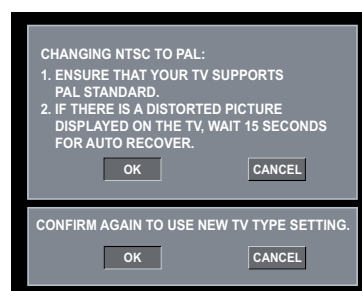

- 6 Press **◀** to highlight { **OK** } and press **OK** to confirm.

To reset to default TV colour system:

- Wait for 15 seconds for the auto recovery.
- OR**
- 1 Press **OPEN/CLOSE ▲** on the DVD player to open the disc tray.
 - 2 Press **numeric keypad '3'** on the remote control for few seconds.
→ The DVD background menu appears.

Tips:

- Before changing the current TV colour setting, ensure that your TV supports the 'selected TV Type' system.
- If there is no proper picture on your TV, wait for 15 seconds for auto recovery.

TIPS: The underlined option is the factory default setting.
Press **◀** to go back to previous menu item. Press **SETUP** to exit the menu item.

Getting Started (continued)

Step 5 : Setting the language

The language options are different depending on your country or region. It may not correspond to the illustrations shown on the user manual.

On-screen display (OSD) language

Select this to change the language of this DVD player screen display menu.

The menu language (on-screen display) for the system will remain as you set it.



- 1 Press **SETUP**.
- 2 Press **▲ ▼** to select { **OSD Language** }, then press **▶**.
- 3 Use **▲ ▼** to select a language and press **OK** to confirm.

Audio, Subtitle and Disc menu languages

You can choose your preferred language or sound track from audio, subtitles and disc menu languages. If the selected language is not available on the disc, the disc's default language will be used instead.

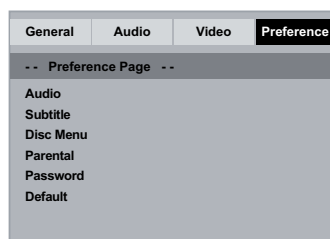

- 1 Press **STOP** **■** twice to stop playback, (if any), then press **SETUP**.
- 2 Press **▶** to select { **Preference Page** }.
- 3 Press **▲ ▼** to highlight one of the options below, then press **▶**.

{ **Audio** }

Select this to change disc sound track language.

{ **Subtitle** }

Select this to change the subtitle language.

{ **Disc Menu** }

Select this to change the language of the disc menu.

- 4 Use **▲ ▼** to select a language and press **OK** to confirm.

If the language you want is not in the list, then select { Others }, then use the numeric keypad (0-9) on the remote to enter the 4-digit language code 'XXXX' (see page 5 'Language Code') and press **OK.**

- 5 Repeat steps 3 - 4 for other language settings.

TIPS: The underlined option is the factory default setting.
Press **◀** to go back to previous menu item. Press **SETUP** to exit the menu item.

Playback from Disc

IMPORTANT!

- If the inhibit icon  appears on the TV screen when a button is pressed, it means the function is not available on the current disc or at the current time.
- DVD discs and players are designed with regional restrictions. Before playing a disc, make sure the disc is for the same zone as your player.

Playable discs

Using this DVD player, you can playback on the following discs:

DVD Video (Digital Versatile Disc)



DVD±RW (DVD Rewritable) Audio/Video format or MP3/WMA/JPEG files.



DVD±R (DVD Recordable) Audio/Video format or MP3/WMA/JPEG files.



CD-R (CD-Recordable) Audio/Video format or MP3/WMA/JPEG files.



CD-RW (CD-Rewritable) Audio/Video format or MP3/WMA/JPEG files.



Audio CD (Compact Disc Digital Audio)



Video CD
(Formats 1.0, 1.1, 2.0)



Super Video CD



MP3-Disc



Supported formats

MP3/WMA tracks

- The file extensions has to be '.mp3', '.wma'
- JPEG/ISO format
- Maximum 14 characters display.
- Supported bit-rate;
32 – 320 kbps (MP3)
32 – 192 kbps (WMA)





JPEG pictures

- The file extensions has to be '.JPG' and not '.JPEG.'
- JPEG/ISO format
- It can only display DCF-standard still pictures or JPEG pictures such as TIFF.

TIPS: Some discs cannot be played on this DVD player due to the configuration and characteristics of the disc, or due to the condition of recording and authoring software that was used.

Playback Features

Starting disc playback

- 1 Turn on the TV to the correct program number for the DVD player (e.g. 'EXT', '0', 'AV').
- 2 Press **STANDBY-ON**  to turn on the DVD player.
- 3 Press **OPEN/CLOSE**  on the front of the DVD player.
 - You can also hold down the **STOP**  button on the remote control to open and close the disc tray.
- 4 Place a disc into the disc tray with the label facing up, then press **OPEN/CLOSE** .
 - For double-sided discs, load the side which you want to play facing up.
- 5 Playback may start automatically. If not, press **PLAY/PAUSE** .
- If a disc menu appears on the TV, see page 23 'Using the Disc Menu'.
- If the child lock was activated for the inserted disc, you have to enter your six-digit password (see page 34).
- For more playback features, see pages 22~27.



Tips:

- Do not overturn the DVD player while disc loading, playing or ejecting.
- Do not close the disc tray manually even if the power switched off.



Basic playback controls

Unless otherwise stated, all operations described are based on Remote Control use.

Pausing playback

- 1 During playback, press **PLAY/PAUSE**  to pause playback and display a still picture.
 - Sound will be muted.
- 2 To resume normal playback, press **PLAY/PAUSE**  again.

Selecting title/chapter/track

- During playback, press **PREV**  to go to the beginning of the current chapter/track, press **PREV**  again to go to the previous title/chapter/track.
- Press **NEXT**  to go to the next chapter/track.
- Press **DISPLAY** to display the disc information text line for title/chapter/track (example - 00/08).
- Use **alphanumeric keypad (0-9)** to enter valid title/chapter/track number.
 - The playback skips to the selected title/chapter/track.

Stopping playback

- Press **STOP** .

Tips:

- Screen saver will start automatically if the disc playback is stopped/paused for about 5 minutes.
- The player will automatically switch to Power Standby mode if you do not press any buttons for about 15 minutes after the disc has stopped playing.

TIPS: The operating features described here might not be possible for certain discs. Always refer to the instructions supplied with the discs.

Playback Features (continued)

Operations for video playback

Using the Disc Menu

Depending on the disc, a menu may appear on the TV screen once you load in the disc.

To select a playback feature or item

- Use **▲ ▼ ◀ ▶** keys or **numeric keypad (0-9)** on the remote, then press **OK** to start playback.

To access or remove the menu

- Press **DISC MENU** on the remote.

Zooming in

This function allows you to enlarge the picture on the TV screen and to pan through the enlarged picture.

- 1 During playback, press **ZOOM** repeatedly to display the picture with different scales.
 - Use **▲ ▼ ◀ ▶** keys to pan through the enlarged picture.
 - Playback will continue.
- 2 Press **ZOOM** repeatedly to return to the original size.

Slow Motion

You can slow forward a disc during playback and select a different speed.

For DVD,VCD,SVCD

- 1 Press **▲** during playback to select the required speed: 1/2, 1/4, 1/8 or 1/16.
 - Sound will be muted.
- 2 To return to normal speed, press **PLAY/PAUSE ▶II**.

Forward / Reverse Searching

You can fast forward or fast reverse a disc during playback and select a desired search speed.

For DVD,VCD,SVCD,CD,MP3,WMA

- 1 Press **◀ ▶** directly or press **◀▶** for 2 seconds during playback to select the required speed: 2X, 4X, 8X, 16X or 32X (backward or forward).
 - Sound will be muted (DVD/VCD) or intermittent (MP3/WMA/CD).
- 2 To return to normal speed, press **PLAY/PAUSE ▶II**.

TIPS: The operating features described here might not be possible for certain discs. Always refer to the instructions supplied with the discs.

Playback Features (continued)

Selecting various repeat functions

Repeat play mode

The repeat play options vary depending on the disc type.

- 1 While playing a disc, press **REPEAT** continuously to choose a repeat options.

For DVD

- Chapter (currently playing chapter)
- Title (currently playing title)
- All (entire disc)
- Off (cancel)

For Video CD

- Track (currently playing track)
- All (entire disc)
- Off (cancel)

For MP3/WMA/Audio CD

- Repeat One (currently playing file)
- Repeat Folder (current folder)
- Folder (playing all files in one folder once)
- Single (currently playing file once).

For JPEG

In STOP mode,

- Repeat One (currently playing file)
- Repeat Folder (current folder)
- Folder (playing all files in one folder once)
- Single (currently playing file once).

In PLAY mode,

- Repeat One (currently playing file)
- Repeat All (all files in the selected folder)
- Repeat Off (playing all files in one folder once)
- Single (currently playing file once).

- 2 To cancel repeat playback, press **STOP** ■.

Tip:

– For VCD, repeat playback is not possible if the PBC mode is switched on.

Repeating a section within a chapter/track

You can repeat the playback of a specific segment within a title/chapter track. To do this, you must mark the start and end of the segment you want.

- 1 While playing a disc, press **REPEAT A-B** at your chosen starting point.
- 2 Press **REPEAT A-B** again at your chosen end point.
 - The section A and B can be set only within the same chapter/track.
 - The section will now repeat continuously.
- 3 To exit the sequence, press **REPEAT A-B**.

TIPS: The operating features described here might not be possible for certain discs. Always refer to the instructions supplied with the discs.

Playback Features (continued)

Viewing the disc playback information

Using the OSD menu

This function displays disc information on the TV screen during playback.

- 1 During playback, press **DISPLAY** repeatedly on the remote control.
→ The available disc information appears on the TV screen.
- 2 Press ◀▶ to select an option.
- 3 Enter a valid number in the edit box using the alphanumeric keypad 0-9.
→ The playback will change to the selected angle/title/chapter/track or chosen time.

For DVD

- {_/X Angle}: selecting the playing angle for a multi-angle disc.
- {Title XX/XX Chapter--/XX}: enable to select the available title and chapter for viewing.
- {Title XX/XX Time--:--:--}: enable to select the available title and title playing time for viewing.
- {Chapter XX/XX Time--:--:--}: enable to select the available chapter and chapter playing time for viewing.

For VCD

- {Disc Go To: --:--}: enable to select any part within the disc
- {Track Go To: --:--}: enable to select any part within the current track
- {Select Track: --:--}: enable to select any track within the disc

Tip:

- Wait for 5 seconds for the display information to disappear.

TIPS: The operating features described here might not be possible for certain discs. Always refer to the instructions supplied with the discs.

Playback Features (continued)

Special DVD Features

Playing a Title

- 1 Press **DISC MENU**.
→ The disc title menu appears on the TV screen.
- 2 Use **▲ ▼ ◀ ▶** keys or **alphanumeric keypad 0-9** to select a play option.
- 3 Press **OK** key to confirm.

Changing the Audio Language

For DVD

- Press **AUDIO** repeatedly to select different audio languages.

Changing the Audio Channel For VCD

- Press **AUDIO** to select the available audio channels provided by the disc (MONO LEFT, MONO RIGHT, MIX-MONO, STEREO).

Subtitles

- Press **SUBTITLE** repeatedly to select different subtitle languages.

Special VCD and SVCD Feature

Playback Control (PBC)

For VCD with Playback Control (PBC) feature (version 2.0 only)

- Press **DISC MENU** to toggle between 'PBC ON' and 'PBC OFF'.
→ If you select 'PBC ON', the disc menu (if available) will appear on the TV.
→ Use the **PREV ◀ / NEXT ▶** to go to previous/next page or use the **alphanumeric keypad 0-9** to select a play option.
- During playback, pressing **RETURN/TITLE** will return to the menu screen (if PBC is on).

If you want to skip the index menu and playback directly from the beginning,

- Press **DISC MENU** key on the remote control to turn to PBC off.

TIPS: The operating features described here might not be possible for certain discs. Always refer to the instructions supplied with the discs.

Playback Features (continued)

Playing MP3/WMA/JPEG/ Kodak Picture CD

This DVD player can playback MP3, WMA, JPEG and picture CD files on a personally recorded CD-R/RW disc and commercial CD.

IMPORTANT!

You have to turn on your TV and set to the correct Video In channel. (See page 17 'Finding your viewing channel').

General Operation

- 1 Load a disc.
 - The disc reading time may exceed 30 seconds due to the complexity of the directory/file configuration.
 - The data disc menu appears on the TV screen.



- 2 Press **PREV** ◀ / **NEXT** ▶ to go to previous / next page of the menu.
- 3 Press ▲ ▼ to select the folder and press **OK** to open the folder.
- 4 Press ▲ ▼ to select a track/file.
- 5 Press **OK** to confirm.

Playback selection

During playback, you can;

- Press **PREV** ◀ / **NEXT** ▶ to select the previous/next track/file in the current folder.
- Press **PLAY/PAUSE** ▶|| repeatedly to pause/resume playback.

TIPS: The operating features described here might not be possible for certain discs. Always refer to the instructions supplied with the discs.

DVD Menu Options

This DVD Player setup is carried out via the TV, enabling you to customize the DVD player to suit your particular requirement.

Using the General setup menu

- 1 Press **SETUP** on the remote control.
→ The system setup menu appears.

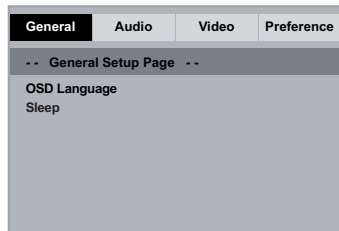

- 2 Press **▲ ▼** to select an item, then press **▶** to access.
Example: { **OSD Language** }
→ The options for the selected item appears.
→ If the selection in the menu is greyed out, that means the feature is not available or not possible to change at the current state.
- 3 Use **▲ ▼** to select a setting and press **OK** to confirm.
Example: { **English** }
→ The setting is selected and setup is complete.
- 4 To exit, press **SETUP**.

OSD Language

This menu contains various language options for the language displayed on the screen. For details, see page 20.

Sleep

Sleep function allows you to turn off the DVD player automatically after a preset time.

- 1 In 'General Setup Page', press **▲ ▼** to select { **Sleep** }, then press **▶**.
{ **15 Mins** }
Turn off the DVD player after 15 minutes.
{ **30 Mins** }
Turn off the DVD player after 30 minutes.
{ **45 Mins** }
Turn off the DVD player after 45 minutes.
{ **60 Mins** }
Turn off the DVD player after 60 minutes.
{ **Off** }
Turn off the sleep function.
- 2 Use **▲ ▼** to select a setting and press **OK** to confirm.

TIPS: The underlined option is the factory default setting.
Press **◀** to go back to previous menu item. Press **SETUP** to exit the menu item.

DVD Menu Options (continued)

Using the Audio setup menu

- 1 Press **SETUP** on the remote control.
→ The system setup menu appears.

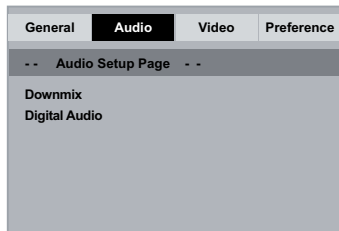

- 2 Press **◀ ▶** to select { **Audio Setup Page** }.
- 3 Press **▲ ▼** to select an item, then press **▶** to access.
Example: { **Downmix** }
→ The options for the selected item appears.
→ If the selection in the menu is greyed out, that means the feature is not available or not possible to change at the current state.
- 4 Use **▲ ▼** to select a setting and press **OK** to confirm.
Example: { **Stereo** }
→ The setting is selected and setup is complete.
- 5 To exit, press **SETUP**.

Downmix

This option allows you to set the stereo analog output of your DVD player.

- 1 In 'Audio Setup Page', press **▲ ▼** to select { **Downmix** }, then press **▶**.

{ **Stereo** }

Select this option when output delivers sound from only the two front speakers.

{ **LT/RT** }

Select this option if your DVD player is connected to a Dolby Pro Logic decoder.

- 2 Use **▲ ▼** to select a setting and press **OK** to confirm.

Digital Audio

The options included in Digital Audio are: {Digital Output} and {LPCM Output}.

- 1 In 'Audio Setup Page', press **▲ ▼** to select { **Digital Audio** }, then press **▶**.
- 2 Press **▲ ▼** to select an item, then press **▶** to access.
- 3 Use **▲ ▼** to select a setting and press **OK** to confirm.

TIPS: The underlined option is the factory default setting.
Press **◀** to go back to previous menu item. Press **SETUP** to exit the menu item.

DVD Menu Options (continued)

Digital Output

Set the Digital Output according to your optional audio equipment connection.

{ All }

Select this if the connected device has a built-in multichannel decoder that supports one of the multichannel audio format (Dolby Digital, MPEG-2).

{ PCM Only }

Select this if the connected device is not capable of decoding multichannel audio. The DVD player will convert the Dolby Digital and MPEG-2 multichannel signals to PCM (Pulse Code Modulation).

{ SPDIF Off }

To deactivate the digital audio output. For example, if you use the AUDIO OUT sockets to connect to a TV or stereo system.

LPCM Output

If you connect the DVD player to a PCM compatible receiver via the digital terminals, such as coaxial or optical etc, you may need to adjust 'LPCM Output'.

{ 48K }

Playback a disc recorded at the sampling rate of 48kHz.

{ 96K }

Playback a disc recorded at the sampling rate of 96kHz. This rate can only be achieved in Stereo-Classic (Flat) mode.

Tip:

– Discs are recorded at a certain sampling rate. The higher the sampling rate, the better sound quality. LPCM Output can be selected only when PCM Only is activated.

Using the Video setup menu

- 1 Press **SETUP** on the remote control.
→ The system setup menu appears.

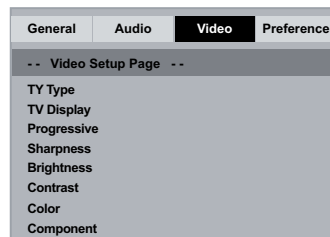

- 2 Press ◀ ▶ to select { **Video Setup Page** }.
- 3 Press ▲ ▼ to select an item, then press ▶ to access.
Example: { **TV Type** }
→ The options for the selected item appears.
→ If the selection in the menu is greyed out, that means the feature is not available or not possible to change at the current state.
- 4 Use ▲ ▼ to select a setting and press **OK** to confirm.
Example: { **PAL** }
→ The setting is selected and setup is complete.
- 5 To exit, press **SETUP**.

TIPS: The underlined option is the factory default setting.
Press ◀ to go back to previous menu item. Press **SETUP** to exit the menu item.

DVD Menu Options (continued)

TV Type

This menu contains the options for selecting the color system that matches the connected TV. For details, see page 19.

Setting the TV Display

The picture shape can be adjusted to fit your TV and the format must be available on the playback disc. Otherwise, the TV display will not affect the picture during playback.

- 1 In 'Video Setup Page', press ▲ ▼ to select { **TV Display** }, then press ►.

{ **4:3 Pan Scan** }

Select this if you have a normal TV and want both sides of the picture to be trimmed or formatted on the TV screen.

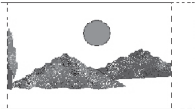

{ **4:3 Letter Box** }

Select this if you have a normal TV. A 'wide-screen' display with black bars on the top and bottom will be displayed on the TV screen.



{ **16:9** }

Select this for wide-screen TV (frame ratio 16:9).



- 2 Use ▲ ▼ to select a setting and press **OK** to confirm.

Progressive

In the progressive scan mode, you can enjoy the high quality picture with less flickers. It only works when you have connected the DVD player's YPbPr jacks to your TV that supports the progressive video input. Otherwise, a distorted picture will appear on the TV. For proper progressive scan set up, see page 18.

- 1 In 'Video Setup Page', press ▲ ▼ to select { **Progressive** }, then press ►.

{ **Off** }

To disable Progressive Scan function.

{ **On** }

To enable Progressive Scan function.

- 2 Use ▲ ▼ to select a setting and press **OK** to confirm.
 - Follow the instructions shown on the TV screen to confirm the selection (if any).
 - If a distorted picture appears on the TV screen, wait for 15 seconds for auto recovery.

TIPS: The underlined option is the factory default setting.
Press ◀ to go back to previous menu item. Press **SETUP** to exit the menu item.

DVD Menu Options (continued)

Sharpness

You can personalize your picture colour by adjusting sharpness.

- 1 In 'Video Setup Page', press ▲ ▼ to select { **Sharpness** }, then press ►.
{ **H**igh }
Choose high to make the picture's edge sharper.
{ **M**edium }
Choose medium to get a standard picture.
{ **L**ow }
Choose low to make the picture's edge softer.
- 2 Use ▲ ▼ to select a setting and press **OK** to confirm.

Brightness/Contrast/Color

Increasing the value will brighten the picture or vice versa. Choose zero (0) for average setting.

- 1 In 'Video Setup Page', press ▲ ▼ to select { **Brightness** }, { **Contrast** }, { **Color** }, then press ►.
→ The menu will appear on the TV screen.

Brightness 0

Contrast 0

Color 0

- 2 Press ▲ ▼ ◀ ▶ to adjust the setting that best suits your personal preference.
- 3 Press **OK** to confirm.

Component

This setting allows you to toggle the output of the video signal between RGB (on scart) and Interlace YPbPr.

- 1 In 'Video Setup Page', press ▲ ▼ to select { **Component** }, then press ►.
{ **I**nterlace }
Select this for Interlace YPbPr connection.
{ **R**GB }
Select this for scart connection.
- 2 Use ▲ ▼ to select a setting and press **OK** to confirm.

Warning:
When the DVD player is set to YPbPr (YUV), some TV may not properly synchronise with the player on the SCART connector.

TIPS: The underlined option is the factory default setting.
Press ◀ to go back to previous menu item. Press **SETUP** to exit the menu item.

DVD Menu Options (continued)

Using the Preference setup menu

- 1 Press **STOP** ■ twice to stop playback, (if any), then press **SETUP** on the remote control.
→ The system setup menu appears.

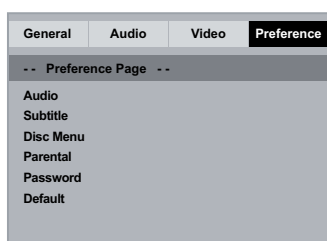

- 2 Press **▶** to select { **Preference Page** }.
- 3 Press **▲ ▼** to select an item, then press **▶** to access.
Example: { **Parental** }
→ The options for the selected item appears.
→ If the selection in the menu is greyed out, that means the feature is not available or not possible to change at the current state.
- 4 Use **▲ ▼** to select a setting and press **OK** to confirm.
Example: { **8 Adult** }
→ The setting is selected and setup is complete.
- 5 To exit, press **SETUP**.

Subtitle/Audio/Disc Menu

These menus contain various language options for audio, subtitle and disc menu which may be recorded on the DVD. For details, see page 20.

Parental

Depending on the DVD, you may be asked to change the parental level while playing the disc. The rating levels are from 1 to 8 and are country dependent. You can prohibit the playing of certain discs that are not suitable for your children, or have certain discs played with alternative scenes.

- 1 In 'Preference Page', press **▲ ▼** to select { **Parental** }, then press **▶**.

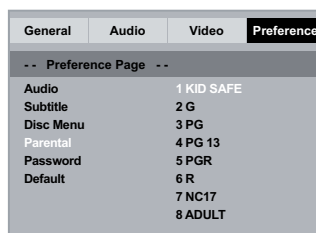

- 2 Use **▲ ▼** to select a rating level and press **OK** to confirm.
→ Select { **8 Adult** } to disable parental level and allow all discs to play.
- 3 Use the **alphanumeric keypad 0-9** to enter the six-digit password (see page 34 'Changing the Password'), then press **OK** to confirm.
- DVDs that are rated higher than the level you selected will not play unless you enter your six-digit password.

TIPS: The underlined option is the factory default setting.
Press **◀** to go back to previous menu item. Press **SETUP** to exit the menu item.

DVD Menu Options (continued)

Rating Explanations

{ **1. Kid Safe** }

Childsafe; acceptable for viewers of all ages.

{ **2. G** }

General Audience; recommended as acceptable for viewers of all ages.

{ **3. PG** }

Parental Guidance suggested.

{ **4. PG – 13** }

Unsuitable for children under age 13.

{ **5. PG – R** }

Parental Guidance; recommended that parents restrict children under 17 from viewing.

{ **6. R** }

Restricted; recommended only when supervised by a parent or adult guardian.

{ **7. NC – 17** }

No Children under age 17; not recommended viewing for children under age 17.

{ **8. Adult** }

Mature Material; should be viewed only by adults due to graphic sexual material, violence or language.

Tips:

- This feature will not limit viewing if the disc manufacturer did not code the disc.
- VCD, SVCD, CD have no level indication, so parental control has no effect on these type of discs. This also applies to most illegal DVDs.
- Some DVDs are not coded with a rating though the movie rating may be printed on the disc cover. The rating level feature does not prohibit play of such discs.

Changing the Password

You need to enter your six-digit password to play a prohibited disc or if prompted for a password. The same default password is used for Parental.

- 1 In 'Preference Page', press ▲ ▼ to select { **Password** }, then press ► to select { **Change** }.
- 2 Press **OK** and the menu appears on the TV screen.

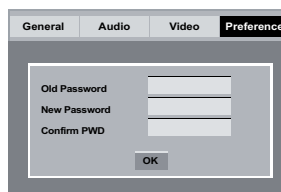

- 3 Use the **alphanumeric keypad 0-9** to enter the six-digit password.
→ When doing this for the first time, enter the default password '136900'.
- If you forget your old six-digit password, enter the default password '136900'.
- 4 Enter the new six-digit password.
- 5 Enter the new six-digit password a second time to confirm.
→ The new six-digit password will now take effect.
- 6 Press **OK** to confirm.

Restoring to the original settings

Setting the { **Default** } function will reset all options and your personal settings to the factory defaults, except your Parental.

- 1 In 'Preference Page', press ▲ ▼ to select { **Default** }, then press ► to select { **Reset** }.
- 2 Press **OK** to confirm.
→ All settings will now reset to factory defaults.

TIPS: The underlined option is the factory default setting.
Press ◀ to go back to previous menu item. Press **SETUP** to exit the menu item.

Software upgrade

Periodically Philips will issue software upgrade to enhance your user experience.

IMPORTANT!

– **Power supply must not be interrupted during upgrade!**

To check the current software version of this DVD player;

- 1 Press **OPEN/CLOSE ▲** on the DVD player to open the disc tray.
→ The disc tray will open.
- 2 Press **numeric keypad '55'** on the remote control.
→ The file name of the software installed in the DVD player appears on the TV screen.

To download and install the latest software to the DVD player;

- 1 Visit the Philips website 'www.philips.com/support' to check the availability of the latest software upgrade.
- 2 Download the software to a CD-R.
- 3 Insert the CD-R to the disc slot.
→ The menu appears on the TV screen.

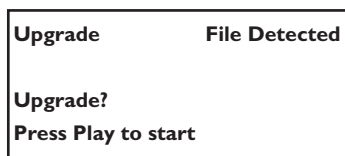

- 4 Press **PLAY/PAUSE ►II** to download the latest software in the DVD player.
→ The DVD player will re-start automatically once the download complete.

Troubleshooting

WARNING

Under no circumstances should you try to repair the system yourself, as this will invalidate the warranty. Do not open the system as there is a risk of electric shock.

If a fault occurs, first check the points listed below before taking the system for repair. If you are unable to remedy a problem by following these hints, consult your dealer or Philips for help.

Problem	Solution
No power.	<ul style="list-style-type: none">– Press STANDBY-ON button on the front of the DVD player to turn on the system.– Make sure the AC outlet has power.
Remote control does not work.	<ul style="list-style-type: none">– Aim the remote control directly at the sensor on the front of the DVD player (not towards TV).– Remove any obstacles between DVD player and the remote control.– Batteries are weak, replace the batteries.– Check the polarities of the batteries are as indicated on the remote control (± signs).
No picture.	<ul style="list-style-type: none">– Turn on your TV and set to the correct Video In channel for the DVD player. You may go to Channel 1 on your TV, then press the channel down button on your TV's remote control until you see the TV program.– Check the video connection between the DVD player and the TV.
The picture is distorted or black & white during playback.	<ul style="list-style-type: none">– The disc does not match with the TV color system standard (PAL/NTSC).– The disc is dirty, clean the disc.– Sometimes a small amount of picture distortion may appear. This is not a malfunction.– To deactivate progressive scan function manually;<ol style="list-style-type: none">1) Turn off your TV progressive scan mode (or set to interlace mode)2) Press OPEN/CLOSE to open the DVD player disc tray.3) Press the alphanumeric keypad '1' for few seconds.
No sound.	<ul style="list-style-type: none">– Check the audio connections, the red and white jacks are connected correctly.– Set the Digital output correctly, based on the equipment you connected to the DVD player.
Disc does not play.	<ul style="list-style-type: none">– Insert the disc with the label facing up.– Wrong region code.– Wrong disc type. Read chapter "Playback - Playable discs" for details.– Make sure the disc is not scratched or warped. Clean the disc or replace a new one.– Check if the disc is defective by trying another disc.

Need Help? Visit us at www.philips.com/support

Troubleshooting (continued)

Problem	Solution
The aspect ratio of the screen cannot be changed.	<ul style="list-style-type: none">– The aspect ratio is fixed on the DVD disc.– Depending on the TV, it may not be possible to change the aspect ratio.
Not able to select some items in the setup/system menu.	<ul style="list-style-type: none">– Press STOP button twice before selecting the setup/system menu.– Depending on the disc availability, some menu items cannot be selected.
The DVD player does not start playback.	<ul style="list-style-type: none">– Insert a readable disc with the playback side facing down.– Check the disc type, colour system (PAL/NTSC) and region code.– Check for any scratches or smudges on the disc.– Press SETUP to turn off the setup menu screen.– You may need to enter the password in order to change the parental rating level or to unlock the disc for playback.– Moisture may have condensed inside the system. Remove the disc and leave the system turned on for about an hour.– Disconnect the power cord from the power outlet for a few minutes. Reconnect the power cord and try to operate again as usual.
Picture freezes momentarily during playback.	<ul style="list-style-type: none">– Check the disc for fingerprint/scratches and clean with a soft cloth wiping from center to edge.
Unable to select Progressive Scan on/off.	<ul style="list-style-type: none">– Check that the output of the video signal is turn to { YPbPr }.

Need Help? Visit us at www.philips.com/support

Specifications

TV STANDARD (PAL/50Hz) (NTSC/60Hz)

Number of lines	625	525
Playback	Multistandard (PAL/NTSC)	

VIDEO PERFORMANCE

Video DAC	12 bit, 108 MHz	
YPbPr	0.7 Vpp ~ 75 ohm	
Video Output	1Vpp ~ 75 ohm	
RGB (SCART)	0.7 Vpp ~ 75 ohm	

VIDEO FORMAT

Digital	MPEG 2 for DVD,SVCD	
Compression	MPEG 1 for VCD	

DVD	50Hz	60Hz
Horiz. resolution	720 pixels	720 pixels
Vertical resolution	576 lines	480 lines

VCD	50Hz	60Hz
Horiz. resolution	352 pixels	352 pixels
Vertical resolution	288 lines	240 lines

AUDIO FORMAT

Digital	MPEG/ AC-3/ PCM	compressed Digital
		16, 20, 24 bits
		fs, 44.1, 48, 96 kHz
	MP3(ISO 9660)	96, 112, 128, 256 kbps & variable bit rate fs, 32, 44.1, 48 kHz

Analog Sound Stereo
 Dolby Surround compatible downmix from Dolby Digital multi-channel sound

AUDIO PERFORMANCE

DA Converter	24 bit, 192 kHz	
DVD	fs 96 kHz	4Hz- 44kHz
	fs 48 kHz	4Hz- 22kHz
SVCD	fs 48 kHz	4Hz- 22kHz
	fs 44.1kHz	4Hz- 20kHz
CD/VCD	fs 44.1kHz	4Hz- 20kHz
Signal-Noise (1kHz)	> 100 dB	
Dynamic range(1kHz)	> 90 dB	
Crosstalk (1kHz)	> 100 dB	
Distortion/noise (1kHz)	> 85 dB	
MPEG MP3	MPEG Audio L3	

CONNECTIONS

Scart Output	Euroconnector
YPbPr Output	Cinch 3x
Video Output	Cinch (yellow)
Audio Output(L+R)	Cinch (white/red)
Digital Output	1 coaxial
	IEC60958 for CDDA / LPCM
	IEC61937 for MPEG 1/2, Dolby Digital

CABINET

Dimensions (w x h x d)	360 x 37 x 209 mm
Weight	Approximately 2 kg

POWER CONSUMPTION

Power Supply Rating	240V; 50Hz
Power consumption	< 10 W
Power consumption in Standby mode	< 1 W

Glossary

Analog: Sound that has not been turned into numbers. Analog sound varies, while digital sound has specific numerical values. These jacks send audio through two channels, the left and right.

Aspect ratio: The ratio of vertical and horizontal sizes of a displayed image. The horizontal vs. vertical ratio of conventional TVs. is 4:3, and that of wide-screens is 16:9.

AUDIO OUT Jacks: Jacks on the back of the DVD System that send audio to another system (TV, Stereo, etc.).

Bit Rate: The amount of data used to hold a given length of music; measured in kilobits per seconds, or kbps. Or, the speed at which you record. Generally, the higher the bit rate, or the higher the recording speed, the better the sound quality. However, higher bit rates use more space on a Disc.

Chapter: Sections of a picture or a music piece on a DVD that are smaller than titles. A title is composed of several chapters. Each chapter is assigned a chapter number enabling you to locate the chapter you want.

Component Video Out Jacks: Jacks on the back of the DVD System that send high-quality video to a TV that has Component Video In jacks (R/G/B, Y/Pb/Pr, etc.).

Disc menu: A screen display prepared for allowing selection of images, sounds, subtitles, multi-angles, etc recorded on a DVD.

Digital: Sound that has been converted into numerical values. Digital sound is available when you use the DIGITAL AUDIO OUT COAXIAL or OPTICAL jacks. These jacks send audio through multiple channels, instead of just two channels as analog does.

DivX® 3.11/4.x/5.x/6.0: The DivX® codec is a patent-pending, MPEG-4 based video compression technology, developed by DivX® Networks, Inc., that can shrink digital video to sizes small enough to be transported over the internet, while maintaining high visual quality.

Dolby Digital: A surround sound system developed by Dolby Laboratories containing up to six channels of digital audio (front left and right, surround left and right, center and subwoofer).

DTS: Digital Theatre Systems. This is a surround sound system, but it is different from Dolby Digital. The formats were developed by different companies.

JPEG: A very common digital still picture format. A still-picture data compression system proposed by the Joint Photographic Expert Group, which features small decrease in image quality in spite of its high compression ratio.

MP3: A file format with a sound data compression system. 'MP3' is the abbreviation of Motion Picture Experts Group 1 (or MPEG-1) Audio Layer 3. By using MP3 format, one CD-R or CD-RW can contain about 10 times as much data volume as a regular CD can.

Multichannel: DVD is specified to have each sound track constitute one sound field. Multichannel refers to a structure of sound tracks having three or more channels.

Parental Control: A function of the DVD to limit playback of the disc by the age of the users according to the limitation level in each country. The limitation varies from disc to disc; when it is activated, playback will be prohibited if the software's level is higher than the user-set level.

PCM (Pulse Code Modulation): A system for converting analog sound signal to digital signal for later processing, with no data compression used in conversion.

Playback control (PBC): Refers to the signal recorded on video CDs or SVCDs for controlling reproduction. By using menu screens recorded on a Video CD or SVCD that supports PBC, you can enjoy interactive-type software as well as software having a search function.

Progressive Scan: It displays all the horizontal lines of a picture at one time, as a signal frame. This system can convert the interlaced video from DVD into progressive format for connection to a progressive display. It dramatically increases the vertical resolution.

Region code: A system for allowing discs to be played back only in the region designated beforehand. This unit will only play discs that have compatible region codes. You can find the region code of your unit by looking on the product label. Some discs are compatible with more than one region (or ALL regions).

Title: The longest section of a picture or music feature on DVD, music, etc., in video software, or the entire album in audio software. Each title is assigned a title number enabling you to locate the title you want.

VIDEO OUT jack: Jack on the back of the DVD System that sends video to a TV.

WMA: Windows Media Audio. Refers to an audio compression technology developed by Microsoft Corporation. WMA data can be encoded by using Windows Media Player version 9 or Windows Media Player for Windows XP. Files are recognized by their file extension "WMA."

Meet Philips at the Internet
<http://www.philips.com/support>

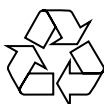
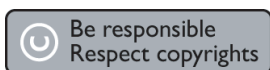

DVP 3120



SgpSL-0703/05-I