

Registre seu produto e obtenha suporte em
www.philips.com/welcome

Immersive

Série 3000



Instruções básicas de uso

PHILIPS

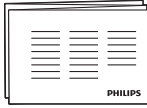

PT Antes de usar o produto, leia todas as informações de segurança em anexo

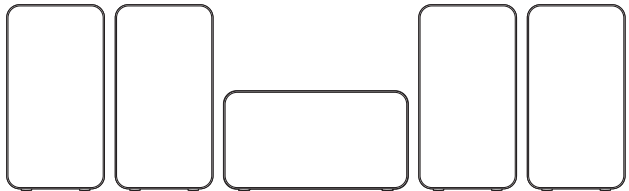
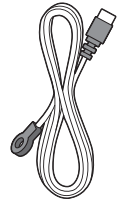
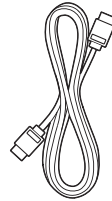
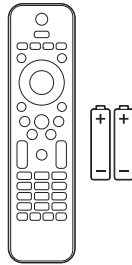
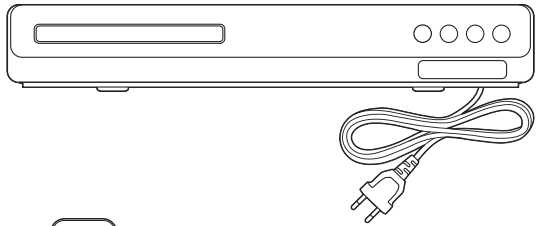
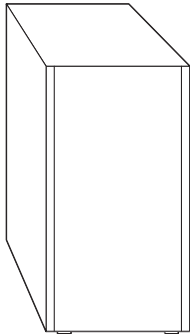
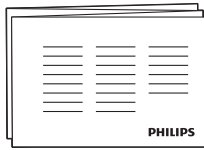
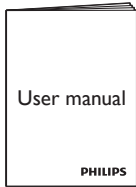

1

PT Conectar o Home Theater

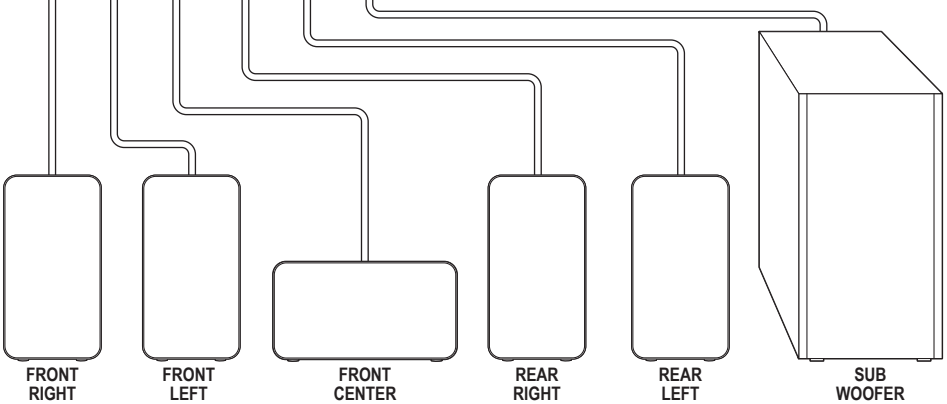
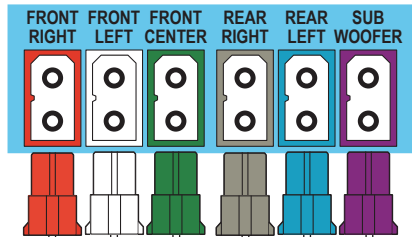
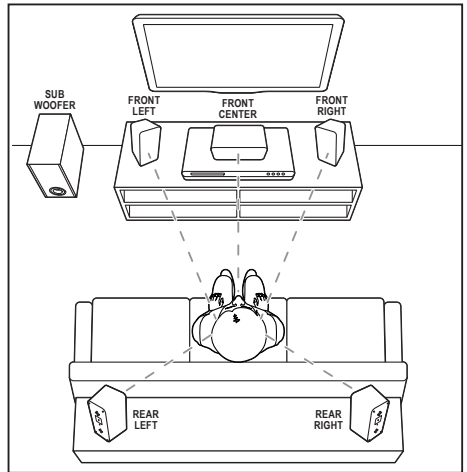
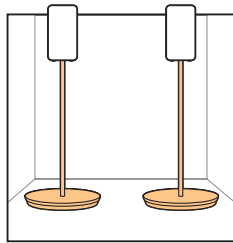

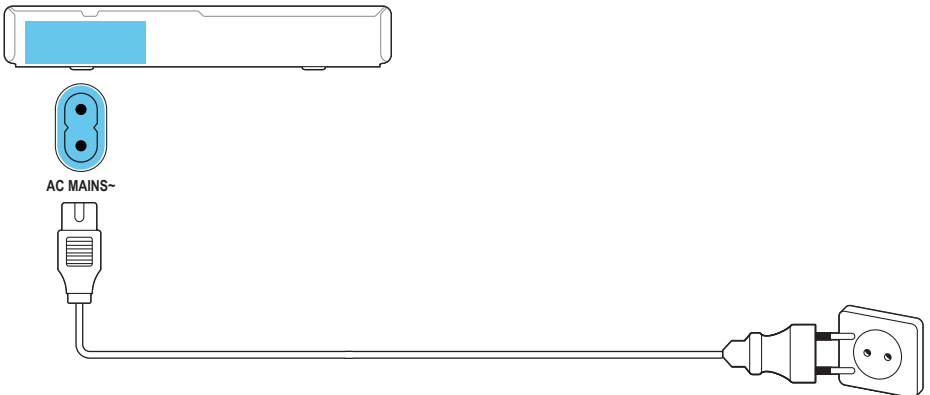
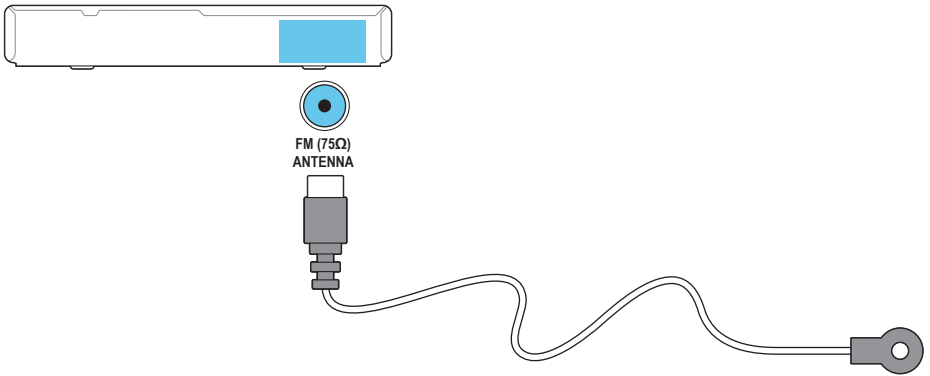
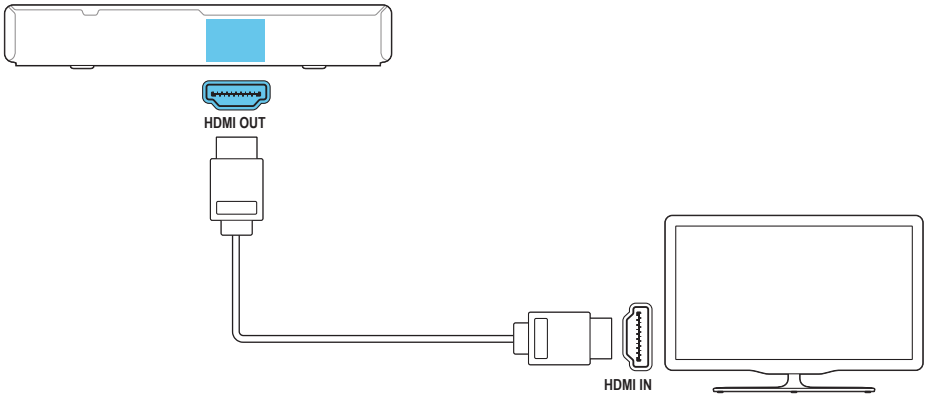

2

PT Ligar o Home Theater

1

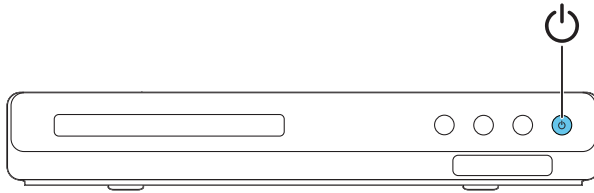

2

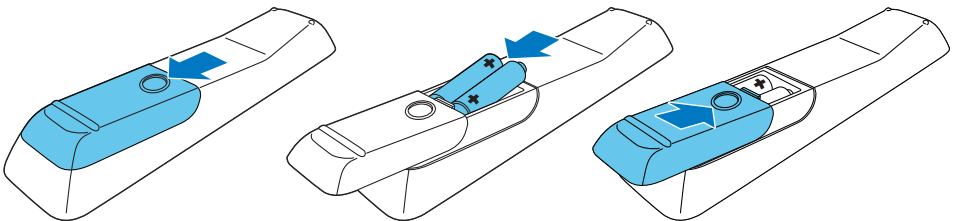

3

PT Fazer a configuração inicial

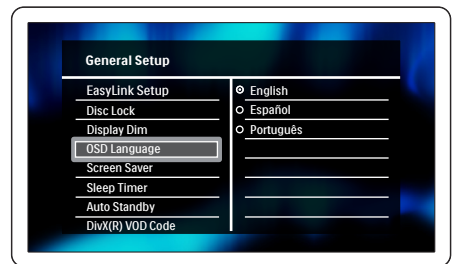
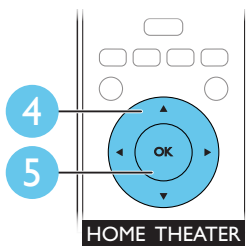
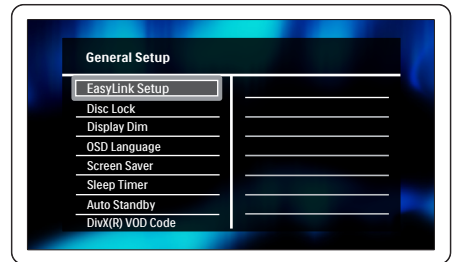
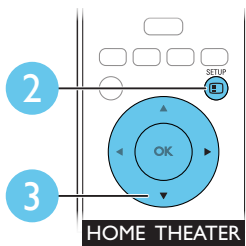
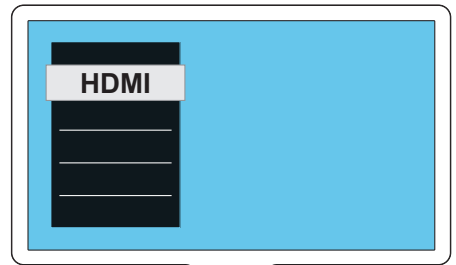
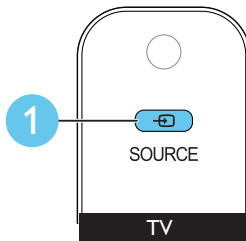
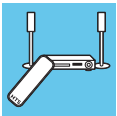

4

PT Usar o Home Theater

