

Register your product and get support at  
[www.philips.com/welcome](http://www.philips.com/welcome)

DCM5090

EN	User manual	3
DA	Brugervejledning	21
DE	Benutzerhandbuch	41
EL	Εγχειρίδιο χρήσης	63
FI	Käyttöopas	87
FR	Mode d'emploi	107
IT	Manuale utente	129
NL	Gebruiksaanwijzing	151



**PHILIPS**



# Contents

<b>1 Important</b>	4
Safety	4
Notice	5
<b>2 Your Docking Entertainment System</b>	7
Introduction	7
What's in the box	7
Overview of the main unit	8
Overview of the remote control	9
<b>3 Get started</b>	10
Connect FM antenna	10
Connect power	11
Prepare the remote control	11
Set clock	11
Turn on	12
<b>4 Play</b>	12
Play from disc	12
Play iPod/iPhone/iPad	12
Play from USB	14
<b>5 Play options</b>	14
Pause/resume play	14
Stop play	14
Skip to a track	14
Search within a track	14
Repeat and shuffle play	14
Program tracks	15
Display ID3 information	15
<b>6 Listen to the radio</b>	15
Tune to a radio station	15
Program radio stations	15
Select a preset radio station	16
Display play information	16
<b>7 Adjust sound</b>	16
Adjust volume	16
Select a preset sound effect	16
Enhance bass	16
Immerse music over a wider spot	16
Mute sound	16
<b>8 Other features</b>	17
Set the sleep timer	17
Set the alarm timer	17
Listen to an external device	17
<b>9 Product information</b>	18
Specifications	18
USB playability information	19
Supported MP3 disc formats	19
<b>10 Troubleshooting</b>	20

# 1 Important

## Safety



This 'bolt of lightning' indicates uninsulated material within your unit may cause an electrical shock. For the safety of everyone in your household, please do not remove product covering.

The 'exclamation mark' draws attention to features for which you should read the enclosed literature closely to prevent operational and maintenance problems. **WARNING:** To reduce the risk of fire or electric shock, this device should not be exposed to rain or humidity and objects filled with liquids, such as vases, should not be placed on this device.

**CAUTION:** To prevent electric shock, match wide blade of plug to wide slot, fully insert.

### Important Safety Instructions

- Read these instructions.
- Heed all warnings.
- Follow all instructions.
- Do not use this device near water.
- Clean only with dry cloth.
- Do not block any ventilation openings. Install in accordance with the manufacturer's instructions.
- Do not install near any heat sources such as radiators, heat registers, stoves, or other devices (including amplifiers) that produce heat.
- Protect the power cord from being walked on or pinched, particularly at plugs, convenience receptacles, and the point where they exit from the device.
- Only use attachments/accessories specified by the manufacturer.
- Unplug this device during lightning storms or when unused for long periods of time.
- Refer all servicing to qualified service personnel. Servicing is required when the device has been damaged in any way, such as power-supply cord or plug is damaged, liquid has been spilled or objects have fallen into the device, the device has been exposed to rain or moisture, does not operate normally, or has been dropped.
- Battery usage **CAUTION** – To prevent battery leakage which may result in bodily injury, property damage, or damage to the unit:
  - Install all batteries correctly, + and - as marked on the unit.
  - Do not mix batteries (old and new or carbon and alkaline, etc.).
  - Remove batteries when the unit is not used for a long time.
  - Batteries (battery pack or batteries installed) shall not be exposed to excessive heat such as sunshine, fire or the like.
- Devices shall not be exposed to dripping or splashing.
- Do not place any sources of danger on the device (e.g. liquid filled objects, lighted candles).
- Where the MAINS plug or an appliance coupler is used as the disconnect device, the disconnect device shall remain readily operable.



**Warning**

- Never remove the casing of this device.
- Never lubricate any part of this device.
- Never place this device on other electrical equipment.
- Keep this device away from direct sunlight, naked flames or heat.
- Never look into the laser beam inside this device.
- Ensure that you always have easy access to the power cord, plug or adapter to disconnect this device from the power.

**Mains fuse**

This information applies only to products with a UK mains plug.

This product is fitted with an approved molded plug. If you replace the fuse, use one with:

- the ratings shown on the plug,
- a BS 1362 approval, and
- the ASTA approval mark.

Contact your dealer if you are not sure about what type of fuse to use.

Caution: To conform with the EMC directive (2004/108/EC), do not detach the plug from the power cord.

**Notice**

Any changes or modifications made to this device that are not expressly approved by Philips Consumer Lifestyle may void the user's authority to operate the equipment.



This product complies with the radio interference requirements of the European Community.



Your product is designed and manufactured with high quality materials and components, which can be recycled and reused.



When this crossed-out wheeled bin symbol is attached to a product it means that the product is covered by the European Directive 2002/96/EC.

Please inform yourself about the local separate collection system for electrical and electronic products.

Please act according to your local rules and do not dispose of your old products with your normal household waste. Correct disposal of your old product helps to prevent potential negative consequences for the environment and human health.



Your product contains batteries covered by the European Directive 2006/66/EC, which cannot be disposed with normal household waste. Please inform yourself about the local rules on separate collection of batteries because correct disposal helps to prevent negative consequences for environmental and human health.

**Environmental information**

All unnecessary packaging has been omitted. We have tried to make the packaging easy to separate into three materials: cardboard (box), polystyrene foam (buffer) and polyethylene (bags, protective foam sheet.)

Your system consists of materials which can be recycled and reused if disassembled by a specialized company. Please observe the local regulations regarding the disposal of packaging materials, exhausted batteries and old equipment.



The making of unauthorized copies of copy-protected material, including computer programs, files, broadcasts and sound recordings, may be an infringement of copyrights and constitute a criminal offence. This equipment should not be used for such purposes.



Windows Media and the Windows logo are trademarks, or registered trademarks of Microsoft Corporation in the United States and/or other countries.



"Made for iPod," "Made for iPhone," and "Made for iPad" mean that an electronic accessory has been designed to connect specifically to iPod, iPhone, or iPad, respectively, and has been certified by the developer to meet Apple performance standards. Apple is not responsible for the operation of this device or its compliance with safety and regulatory standards. Please note that the use of this accessory with iPod, iPhone, or iPad may affect wireless performance. iPod and iPhone are trademarks of Apple Inc., registered in the U.S. and other countries. iPad is a trademark of Apple Inc.

This device includes this label:

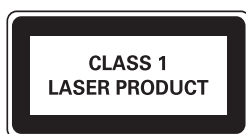

Note

- The type plate is located on the back of the unit.

### Norge

Typeskilt finnes på apparatens underside.

Observer: Nettbryteren er sekundert innkoplet. Den innebygde nettdelen er derfor ikke frakoplet nettet så lenge apparatet er tilsluttet nettkontakten.

For å redusere faren for brann eller elektrisk støt, skal apparatet ikke utsettes for regn eller fuktighet.

## 2 Your Docking Entertainment System

Congratulations on your purchase, and welcome to Philips! To fully benefit from the support that Philips offers, register your product at [www.philips.com/welcome](http://www.philips.com/welcome).

### Introduction

With this unit, you can:

- enjoy audio from discs, USB devices, iPod/iPhone/iPad, and other external devices
- listen to radio stations

You can enrich sound output with these sound effects:

- Dynamic Bass Boost (DBB)
- Digital Sound Control (DSC)
- Living Sound

The unit supports the following media formats:



### What's in the box

Check and identify the contents of your package:

- Main unit
- Remote control with two AAA batteries
- 2 x power cords (for EU and UK)
- MP3 link cable
- FM antenna
- User manual
- Quick start guide

## Overview of the main unit

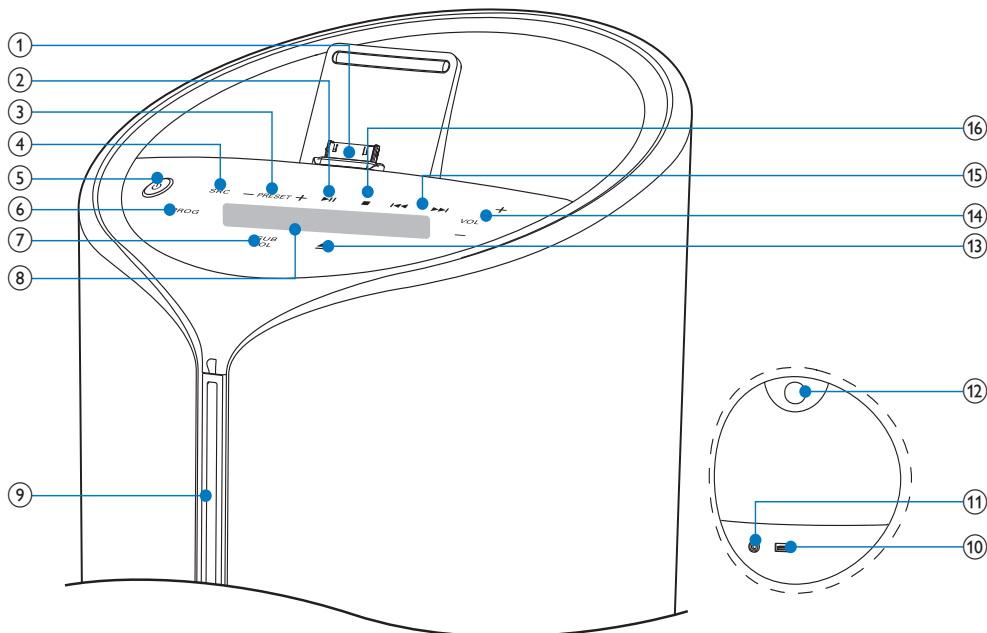

- |  |  |
|--|--|
| <p>① <b>DOCK</b></p> <ul style="list-style-type: none"> <li>• Dock for iPod/iPhone/iPad.</li> </ul> <p>② <b>▶  </b></p> <ul style="list-style-type: none"> <li>• Start or pause play.</li> </ul> <p>③ <b>PRESET +/-</b></p> <ul style="list-style-type: none"> <li>• Select a preset radio station.</li> <li>• Skip to the previous/next album.</li> </ul> <p>④ <b>SRC</b></p> <ul style="list-style-type: none"> <li>• Select a source: CD, FM TUNER, iPod/iPhone/iPad, USB, or MP3 LINK.</li> </ul> <p>⑤ <b>⏻</b></p> <ul style="list-style-type: none"> <li>• Turn the unit on.</li> <li>• Switch to standby mode or Eco power standby mode.</li> </ul> <p>⑥ <b>PROG</b></p> <ul style="list-style-type: none"> <li>• Program tracks.</li> <li>• Program radio stations.</li> <li>• Set the clock.</li> </ul> | <p>⑦ <b>SUB VOL</b></p> <ul style="list-style-type: none"> <li>• Adjust subwoofer volume.</li> </ul> <p>⑧ <b>Display panel</b></p> <ul style="list-style-type: none"> <li>• Show current status.</li> </ul> <p>⑨ <b>Disc compartment</b></p> <p>⑩ <b>USB</b></p> <ul style="list-style-type: none"> <li>• USB socket.</li> </ul> <p>⑪ <b>MP3 LINK</b></p> <ul style="list-style-type: none"> <li>• Connect an external audio device.</li> </ul> <p>⑫ <b>PULL</b></p> <ul style="list-style-type: none"> <li>• Pull to open the protective panel.</li> </ul> <p>⑬ <b>▲</b></p> <ul style="list-style-type: none"> <li>• Eject the disc.</li> </ul> <p>⑭ <b>VOL +/-</b></p> <ul style="list-style-type: none"> <li>• Adjust volume.</li> </ul> |
|--|--|



- ⑮ **⏮ / ⏭**
  - Skip to the previous/next track.
  - Search within a track/disc.
  - Tune to a radio station.
  - Set clock and timer.
- ⑯ **■**
  - Stop play or erase a program.

## Overview of the remote control

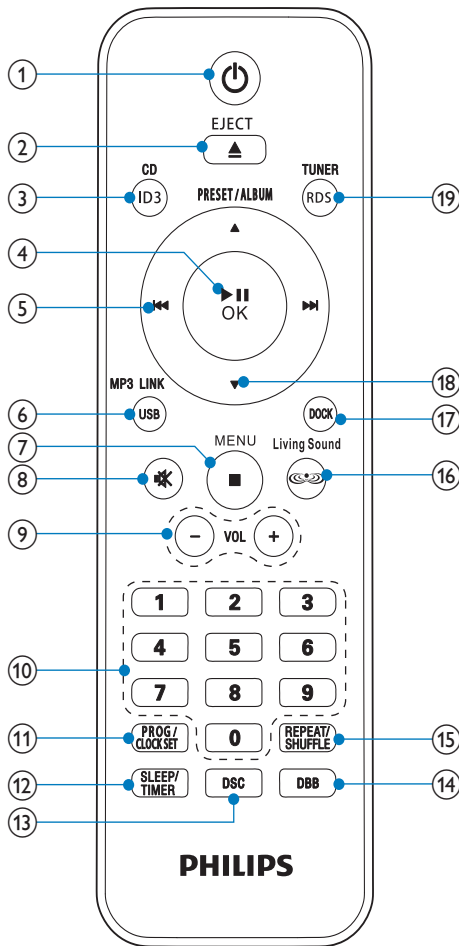

- ① **⏻**
  - Turn the unit on.
  - Switch to standby mode or Eco power standby mode.
- ② **EJECT ▲**
  - Eject the disc.
- ③ **CD/ID3**
  - Select CD source.
  - Display ID3 information.
- ④ **▶▶ / OK**
  - Start or pause play.
  - Confirm a selection.
- ⑤ **⏮ / ⏭**
  - Skip to the previous/next track.
  - Search within a track/disc.
  - Tune to a radio station.
  - Set clock and timer.
- ⑥ **MP3 LINK/USB**
  - Select MP3 LINK or USB source.
- ⑦ **Menu/ ■**
  - Access the iPod/iPhone/iPad menu.
  - Stop play or erase a program.
- ⑧ **🔇**
  - Mute or restore sound.
- ⑨ **VOL +/-**
  - Adjust volume.
- ⑩ **Numeric keypad**
  - Select a track.
  - Select a preset radio station.
- ⑪ **PROG/CLOCK SET**
  - Program tracks.
  - Program radio stations.
  - Set the clock.
- ⑫ **SLEEP/TIMER**
  - Set the sleep timer.
  - Set the alarm timer.
- ⑬ **DSC**
  - Select a preset sound setting.

- ⑭ **DBB**
  - Turn the Dynamic Bass Boost (DBB) on/off.
- ⑮ **REPEAT/SHUFFLE**
  - Select repeat/shuffle play mode.
- ⑯ **Living Sound**
  - Turn the Living Sound effect on/off.
- ⑰ **DOCK**
  - Select iPod/iPhone/iPad source.
- ⑱ **PRESET/ALBUM ▲ / ▼**
  - Select a preset radio station.
  - Skip to previous/next album.
  - Navigate through the iPod/iPhone/iPad menu.
- ⑲ **TUNER/RDS**
  - Select FM source.
  - Display Radio Data System (RDS) information.

## 3 Get started

### ! Caution

- Use of controls, or adjustments or performance of procedures other than herein may result in hazardous radiation exposure or other unsafe operation.

Always follow the instructions in this chapter in sequence.

If you contact Philips, you will be asked for the model and serial number of this device. The model number and serial number are on the back of the device. Write the numbers here:

Model No. \_\_\_\_\_

Serial No. \_\_\_\_\_

### Connect FM antenna

#### \* Tip

- For optimal reception, fully extend and adjust the position of the antenna.

Connect the supplied FM antenna to the **FM AERIAL** jack on the back of the main unit.

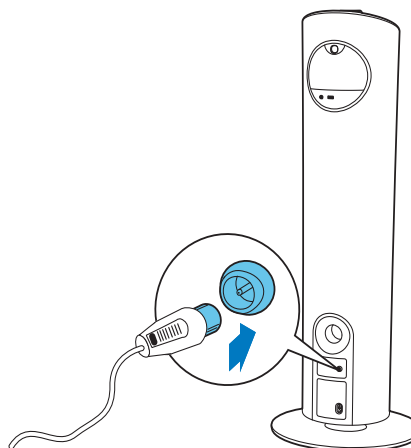

## Connect power

### ! Caution

- Risk of product damage! Ensure that the power supply voltage corresponds to the voltage printed on the back or the underside of the unit.
- Risk of electric shock! When you unplug the AC power cord, always pull the plug from the socket. Never pull the cord.
- Before connecting the AC power cord, ensure you have completed all other connections.

Connect the power cord to:

- the **AC~MAINS** jack on the back of the main unit.
- the wall outlet.

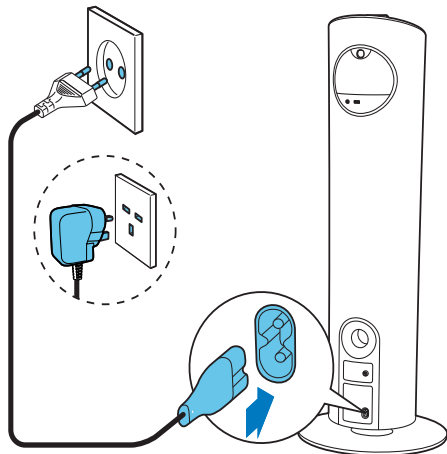

- 2 Insert 2 AAA batteries with correct polarity (+/-) as indicated.
- 3 Close the battery compartment.

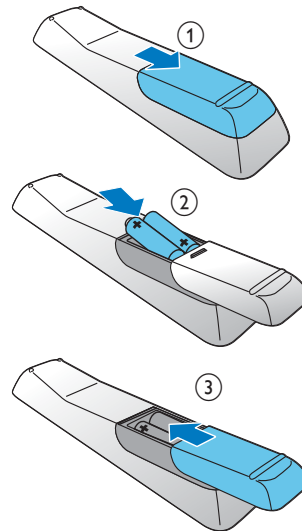

### ≡ Note

- If you are not going to use the remote control for a long time, remove the batteries.
- Do not use old and new or different types of batteries in combination.
- Batteries contain chemical substances, so they should be disposed of properly.

## Prepare the remote control

### ! Caution

- Risk of explosion! Keep batteries away from heat, sunshine, or fire. Never discard batteries in fire.

To insert the remote control battery:

- 1 Open the battery compartment.

## Set clock

- 1 In standby mode, press and hold **PROG/ CLOCK SET** for more than two seconds to activate the clock setting mode.
  - ↳ The 12 hour or 24 hour format is displayed.
- 2 Press **◀◀ / ▶▶** to select 12 hour or 24 hour format, and then press **PROG/ CLOCK SET**.
  - ↳ The hour digits are displayed and begin to blink.

- 3 Press **◀◀/▶▶** to set the hour, and then press **PROG/CLOCK SET**.
  - ↳ The minute digits are displayed and begin to blink.
- 4 Press **◀◀/▶▶** to set the minute.
- 5 Press **PROG/CLOCK SET** to confirm.

---

## Turn on

Press **⏻**.

- ↳ The unit switches to the last selected source.

---

## Switch to standby

Press **⏻** again to switch the unit to standby mode.

- ↳ The backlight on the display panel is reduced.
- ↳ The clock (if set) appears on the display panel.

### To switch to Eco power standby mode:

Press and hold **⏻** for more than two seconds.

- ↳ The backlight on the display panel turns off.

### To switch between normal standby mode and Eco power standby mode:

Press and hold **⏻** for more than two seconds.

#### Note

- If no button is pressed over 15 minutes in standby mode, this device goes to Eco power standby mode automatically.

## 4 Play

---

### Play from disc

- 1 Press **CD** on the remote control or press **SRC** repeatedly on the main unit to select CD source.
- 2 Insert a disc into the disc compartment with the printed side facing right.
  - ↳ The file starts playing automatically. If not, press **▶||**.
    - Press **EJECT ▲** to take the disc out of the disc tray.

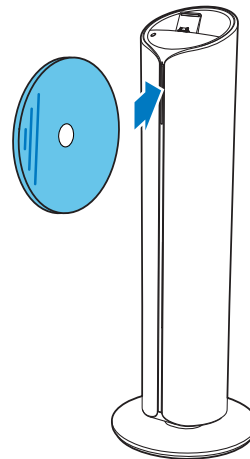

---

### Play iPod/iPhone/iPad

You can enjoy audio from iPod/iPhone/iPad through this docking system.

---

#### Compatible iPod/iPhone/iPad

The unit supports the following iPod/iPhone/iPad models.

- Made for
- iPad 2

- iPad
- iPhone 4
- iPhone 3GS
- iPhone 3G
- iPhone
- iPod classic
- iPod with video
- iPod nano (1st, 2nd, 3rd, 4th, 5th, and 6th generation)
- iPod touch (1st, 2nd, 3rd, and 4th generation)

### Load the iPod/iPhone/iPad

Place the iPod/iPhone/iPad in the dock.



### Listen to the iPod/iPhone/iPad

**Note**

- Make sure that your iPod/iPhone/iPad has been loaded securely.

- 1 Press **DOCK** on the remote control or press **SRC** repeatedly on the main unit to select iPod/iPhone/iPad source.
- 2 Play audio on your iPod/iPhone/iPad.

- ↳ The audio in connected iPod/iPhone/iPad streams from this docking system automatically. If not, press **▶||**.
- To navigate the menu: press **MENU**, and press **▲ / ▼ / ◀◀ / ▶▶** to select, and then press **OK** to confirm.

### Charge the iPod/iPhone/iPad

When the unit is connected to power, the docked iPod/iPhone/iPad begins to charge automatically.

**Note**

- iPod with color display, iPod classic, and iPod with video are not compatible with dock charging.

### Remove the iPod/iPhone/iPad

Pull the iPod/iPhone/iPad out of the dock.

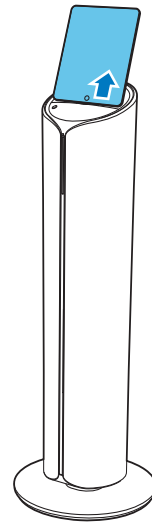



---

## Play from USB

### Note

- Ensure that the USB device contains playable audio content.

- 1 Press **USB** on the remote control or press **SRC** repeatedly on the main unit to select the USB source.
- 2 Insert the USB device into the  (USB) socket on the back of the unit.
  - ↳ The file starts playing automatically. If not, press .

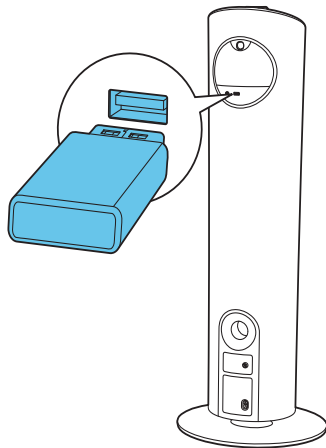

---

## 5 Play options

---

### Pause/resume play

During play, press  to pause/resume play.

---

### Stop play

During play, press  to stop play.



---

### Skip to a track

For CD:

- 1 Press  to select another track.
  - To select a track directly, press a key on the numerical keypad.

For MP3 disc and USB:

- 1 Press  to select an album or folder.
- 2 Press  to select a track or file.



---

### Search within a track

- 1 During play, press and hold  to search within a track.
- 2 Release to resume normal play.

---

### Repeat and shuffle play

- 1 During play, press **REPEAT/SHUFFLE** repeatedly to select:
  -  (repeat one): The current track is played repeatedly.
  -  (repeat all): All tracks are played repeatedly.
  -  (shuffle): All tracks are played in a random sequence.

- 2 To return to normal play, press **REPEAT/SHUFFLE** repeatedly until repeat/shuffle mode is no longer displayed.

### Note

- The repeat and shuffle play cannot be activated at the same time.
- Shuffle play cannot be selected when you play programmed tracks.

## Program tracks

You can program a maximum of 20 tracks.

- 1 In CD/USB mode, at the stop position, press **PROG** to activate the program mode.
  - ↳ **[PROG]** (program) blinks on the display.
- 2 For MP3/WMA tracks, press **▲ / ▼** to select an album.
- 3 Press **◀ / ▶** to select a track number, and then press **PROG** to confirm.
- 4 Repeat steps 2 to 3 to program more tracks.
- 5 Press **▶||** to play the programmed tracks.
  - ↳ During play, **[PROG]** (program) is displayed.
    - To erase the program, in the stop position, press **■**.

## Display ID3 information

In CD mode, during play, press **ID3** to display the following information:

- Track number
- Play time
- Title name
- Artist name
- Album name

## 6 Listen to the radio

### Tune to a radio station

#### Tip

- For optimal FM reception, fully extend and adjust the position of the FM antenna.

- 1 Press **TUNER** on the remote control or press **SRC** repeatedly on the main unit to select the tuner source.
- 2 Press and hold **◀ / ▶** for more than two seconds.
  - ↳ **[SEARCH]** (search) is displayed.
  - ↳ The radio tunes to a station with strong reception automatically.
- 3 Repeat step 2 to tune to more stations.
  - To tune to a weak station, press **◀ / ▶** repeatedly until you find optimal reception.

### Program radio stations

#### Tip

- You can program a maximum of 20 preset radio stations.

### Program radio stations automatically

In tuner mode, press and hold **PROG** for more than two seconds to activate automatic program mode.

- ↳ **[AUTO SRCH]**(auto search) is displayed.
- ↳ All available stations are programmed in the order of waveband reception strength.
- ↳ The first programmed radio station is broadcast automatically.

---

## Program radio stations manually

- 1 Tune to a radio station.
- 2 Press **PROG** to activate program mode.  
↳ **[PROG]** (program) blinks on the display.
- 3 Press **▲** / **▼** to allocate a number (1 to 20) to this radio station, and then press **PROG** to confirm.  
↳ The preset number and the frequency of the preset station are displayed.
- 4 Repeat the above steps to program other stations.

---

### Note

- To overwrite a programmed station, store another station in its place.

---

## Select a preset radio station

In tuner mode, press **▲** / **▼** to select a preset number.

- You can also press the numeric key to select a preset number directly.

---

## Display play information

Radio Data System (RDS) is a service that allows FM stations to show additional information.

In tuner mode, press **TUNER/RDS** repeatedly to show RDS information.

---

# 7 Adjust sound

---

## Adjust volume

During play, press **VOL +/-** to increase/decrease the volume.

---

## Adjust subwoofer volume

During play, press **SUB VOL** on the main unit to increase/decrease the subwoofer volume.

---

## Select a preset sound effect

During play, press **DSC** repeatedly to select:

- **[FLAT]** (flat)
- **[ROCK]** (rock)
- **[CLASSIC]** (classic)
- **[JAZZ]** (jazz)
- **[POP]** (pop)

---

## Enhance bass

During play, press **DBB** to turn on or off dynamic bass enhancement.

↳ If DBB is activated, DBB feature is enabled.

---

## Immerse music over a wider spot

During play, press **Living Sound** to turn on or off the living sound effect.

↳ If Living Sound is activated,  is displayed.

---

## Mute sound

During play, press **M** to mute or restore sound.



## 8 Other features

### Set the sleep timer

This docking system can switch to standby automatically after a set period of time.

- 1 When the unit is turned on, press **SLEEP/TIMER** repeatedly to select a set period of time (in minutes).
  - ↳ When sleep timer is activated, **zZ** is displayed.

#### To deactivate sleep timer

- 1 Press **SLEEP/TIMER** repeatedly until [**SLEEP OFF**] (sleep off) is displayed.
  - ↳ When sleep timer is deactivated, **zZ** disappears.

### Set the alarm timer

This docking system can be used as an alarm clock. You can select CD, FMTUNER, iPod/iPhone/iPad, or USB as alarm source.

#### Note

- Ensure that you have set the clock correctly.

- 1 In standby mode, press and hold **SLEEP/TIMER** until [**SET TIMER**](set timer) scrolls on the display.
- 2 Press **CD**, **USB**, **DOCK**, or **TUNER** to select a source.
- 3 Press **SLEEP/TIMER** to confirm.
  - ↳ The hour digits are displayed and begin to blink.
- 4 Press **◀▶** to set the hour, and then press **SLEEP/TIMER** again.
  - ↳ The minute digits are displayed and begin to blink.
- 5 Press **◀▶** to set the minute.

- 6 Press **SLEEP/TIMER** to confirm.
  - ↳ The alarm timer is set and activated.

### Activate and deactivate the alarm timer

In standby mode, press **SLEEP/TIMER** repeatedly to activate or deactivate the alarm timer.

- ↳ If the alarm timer is activated, **🔔** is displayed
- ↳ If the alarm timer is deactivated, **🔔** disappears.

#### Note

- If CD/USB/iPod/iPhone/iPad source is selected, but no disc is placed or no USB/iPod/iPhone/iPad is connected, the FM TUNER is selected automatically.

### Listen to an external device

You can also listen to an external audio device through this docking system.

- 1 Press **MP3 LINK** to select MP3 link source.
- 2 Connect the supplied MP3 link cable to:
  - the **MP3 LINK** jack on the back of the unit
  - the headphone jack on the device
- 3 Start to play the device. (See the device user manual).

## 9 Product information

### Note

- Product information is subject to change without prior notice.

### Specifications

#### Amplifier

Rated Output Power	200 W
Frequency Response	100 Hz - 16 kHz, $\pm 3$ dB
Signal to Noise Ratio	>70 dB
MP3 LINK Input	<600 mV RMS

#### Disc

Laser Type	Semiconductor
Disc Diameter	12 cm
Support Disc	CD-DA, CD-R, CD-RW, MP3-CD, WMA-CD
Audio DAC	24 Bits / 44.1 kHz
Total Harmonic Distortion	<1%
Frequency Response	60 Hz -16 kHz (44.1 kHz)
S/N Ratio	>65 dBA

#### Tuner

Tuning Range	FM: 87.5 - 108 MHz
Tuning grid	50 KHz
Sensitivity	
- Mono, 26dB S/N Ratio	<22 dBu
- Stereo, 46dB S/N Ratio	<45 dBu
Search Selectivity	<30 dBu
Total Harmonic Distortion	<3%
Signal to Noise Ratio	>45 dB

#### Speakers

Speaker Impedance	6 ohm + 3 x 6 ohm
Speaker Driver	5.25" woofer + 3 x 2.75" full range
Sensitivity	>82 dB/m/W

#### General information

AC power Consumption	220 - 240 V, 50/60 Hz
Standby Power Consumption	< 1 W
USB Direct Load of USB	Version 2.0/1.1 $\leq 500$ mA
Dimensions (W x H x D)	
- Main Unit	350 x 978 x 350 mm
Weight	
- With Packing	15 kg
- Main Unit	11.5 kg

---

## USB playability information

### Compatible USB devices:

- USB flash memory (USB 2.0 or USB1.1)
- USB flash players (USB 2.0 or USB1.1)
- memory cards (requires an additional card reader to work with this unit)

### Supported formats:

- USB or memory file format FAT12, FAT16, FAT32 (sector size: 512 bytes)
- MP3 bit rate (data rate): 32-320 Kbps and variable bit rate
- WMA v9 or earlier
- Directory nesting up to a maximum of 8 levels
- Number of albums/ folders: maximum 99
- Number of tracks/titles: maximum 999
- ID3 tag v2.0 or later
- File name in Unicode UTF8 (maximum length: 128 bytes)

### Unsupported formats:

- Empty albums: an empty album is an album that does not contain MP3/WMA files, and will not be shown in the display.
- Unsupported file formats are skipped. For example, Word documents (.doc) or MP3 files with extension .dlf are ignored and not played.
- AAC, WAV, PCM audio files
- DRM protected WMA files (.wav, .m4a, .m4p, .mp4, .aac)
- WMA files in Lossless format

---

## Supported MP3 disc formats

- ISO9660, Joliet
- Maximum title number: 512 (depending on file name length)
- Maximum album number: 255
- Supported sampling frequencies: 32 kHz, 44.1kHz, 48 kHz
- Supported Bit-rates: 32~256 (kbps), variable bit rates

# 10 Troubleshooting



## Warning

- Never remove the casing of this device.

To keep the warranty valid, never try to repair the system yourself.

If you encounter problems when using this device, check the following points before requesting service. If the problem remains unsolved, go to the Philips web site ([www.philips.com/welcome](http://www.philips.com/welcome)). When you contact Philips, ensure that the device is nearby and the model number and serial number are available.

### No power

- Ensure that the AC power plug of the unit is connected properly.
- Ensure that there is power at the AC outlet.
- To save power, the system switches off automatically 15 minutes after track play reaches the end and no control is operated.

### No sound or poor sound

- Adjust the volume.

### No response from the unit

- Disconnect and reconnect the AC power plug, and then turn on the unit again.

### Remote control does not work

- Before pressing any function button, first select the correct source with the remote control instead of the main unit.
- Reduce the distance between the remote control and the unit.
- Insert the battery with its polarities (+/- signs) aligned as indicated.
- Replace the battery.
- Aim the remote control directly at the sensor on the front of the unit.

### No disc detected

- Insert a disc.
- Check if the disc is inserted with printing side right.
- Wait until the moisture condensation at the lens has cleared.
- Replace or clean the disc.
- Use a finalized CD or correct format disc.

### Cannot display some files in USB device

- The number of folders or files in the USB device has exceeded a certain limit. This phenomenon is not a malfunction.
- The formats of these files are not supported.

### USB device not supported

- The USB device is incompatible with the unit. Try another one.

### Poor radio reception

- Increase the distance between the unit and your TV or VCR.
- If the signal is too weak, adjust the antenna or connect an external antenna for better reception.

### Timer does not work

- Set the clock correctly.
- Switch on the timer.

### Clock/timer setting erased

- Power has been interrupted or the power cord has been disconnected.
- Reset the clock/timer.

