

User manual

Manuel d'utilisation

Manual del usuario





# PHILIPS

## Philips Consumer Electronics

---

HK- 0645-WAS7000  
(report No.)

### EC DECLARATION OF CONFORMITY

We,

Philips Consumer Electronics  
(*manufacturer's name*)

Philips, Glaslaan 2, 5616 JB Eindhoven, The Netherlands  
(*manufacturer's address*)

declare under our responsibility that the electrical product:

Philips  
(*name*)

WAS7000 /12 /05  
(*type or model*)

Wireless Music Station  
(*product description*)

to which this declaration relates is in conformity with the following standards:

EN55013 : 2001	EN 300 328 : 2004
EN55020 : 2002	EN 301 489-1 : 2005
EN 55022: 1998	EN 301 489-17: 2002
EN 55024: 1998	EN 50371 : 2002
EN 60065: 2002	IEC Guide 112 : 2000

(*title and/or number and date of issue of the standards*)

following the provisions of R &TTE Directive 1999/5/EC ( incl. 89/336/EEC & 73/23/EEC & 93/68/EEC directives and is produced by a manufacturing organization on ISO 9000 level.

Eindhoven,  
November 10, 2006  
(*place, date*)

Eric Tijssen  
Program Manager  
PCE I-Lab Entertainment Solutions  
(*signature, name and function*)

# Index

---

English ————— 6

Français ————— 45

Español ————— 88

English

Français

Español

## Important notes for users in the U.K.

### Mains plug

This apparatus is fitted with an approved 13-Amp plug. To change a fuse in this type of plug, proceed as follows:

- 1 Remove fuse cover and fuse.
- 2 Fix the new fuse which should be a BS1362 5-Amp, A.S.T.A. or BSI approved type.
- 3 Refit the fuse cover.

If the fitted plug is not suitable for your socket outlets, it should be cut off and an appropriate plug should be fitted in its place.

If the mains plug contains a fuse, it should have a value of 5 Amp. If a plug without a fuse is used, the fuse at the distribution board should not be greater than 5 Amp.

*Note: The severed plug must be disposed, so as to avoid a possible shock hazard due to it being inserted into another 13-Amp socket.*

### How to connect a plug

The wires in the mains lead are coloured using the following codes: blue = neutral (N), brown = live (L).

- As these colours may not correspond with the colour markings identifying the terminals in your plug, proceed as follows:
  - Connect the blue wire to the terminal marked N or coloured black.
  - Connect the brown wire to the terminal marked L or coloured red.
  - Do not connect either wire to the earth terminal in the plug, marked E (or e) or coloured green (or green and yellow).

Before replacing the plug cover, make sure that the cord grip is clamped over the sheath of the lead and not simply over the two wires.

### Copyright in the U.K.

Recording and playback of any materials may require consent. See Copyright Act 1956 and The Performer's Protection Acts 1958 to 1972.

## Norge

Typeskilt finnes på apparatens bakside.

**Observer: Nettbryteren er sekundert innkoplet. Den innebygde nettdelen er derfor ikke frakoplet nettet så lenge apparatet er tilsluttet nettkontakten.**

For å redusere faren for brann eller elektrisk støt, skal apparatet ikke utsettes for regn eller fuktighet.

CE 0682 ⓘ R&TTE Directive 1999/5/EC					
BE	✓	DK	✓	GR	✓
ES	✓	FR	✓	IT	✓
IE	✓	LU	✓	NL	✓
PT	✓	SE	✓	UK	✓
DE	✓	PL	✓	HU	✓
CZ	✓			NO	✓
				SK	✓

**LGPL Library written offer**

This product contains Linux 2.4.27-vrsl, that is made available under the GNU LGPL license version 2.1 (hereafter called "the Library").

Philips Electronics Hong Kong Ltd. hereby offers to deliver or make available, upon request, for a charge no more than the cost of physically performing source distribution, a complete machine-readable copy of the corresponding source code of the Library on a medium customarily used for software interchange.

Please contact:

Head of Development  
BLC Audio PDCC Development  
5/F., Philips Electronics Building  
5 Science Park East Avenue  
Hong Kong Science Park  
Shatin Hong Kong

This offer is valid for a period of three years after the date of purchase of this product.

**GPL Package written offer**

This product contains Linux 2.4.27-vrsl, that is made available under the GNU GPL license version 2 (hereafter called "the Program").

Philips Electronics Hong Kong Ltd. hereby offers to deliver or make available, upon request, for a charge no more than the cost of physically performing source distribution, a complete machine-readable copy of the corresponding source code of the Program on a medium customarily used for software interchange.

Please contact:

Head of Development  
BLC Audio PDCC Development  
5/F., Philips Electronics Building  
5 Science Park East Avenue  
Hong Kong Science Park  
Shatin Hong Kong

This offer is valid for a period of three years after the date of purchase of this product.

# Contents

---

## 1. General information

1.1 About WAS7000	8
1.2 Supplied accessories	8
1.3 Phillips on-line support	9
1.4 Environmental information	10
1.5 Maintenance	10
1.6 Safety information	11

---

## 2. Controls

2.1 Controls on the Station	12-13
2.2 Station's remote control	14-15
2.3 Icons on LCD display	15

---

## 3. Installation

3.1 Placing Station	16
3.2 Setting up Wi-Fi connection between Center and Station	16
3.3 Rear connections	17-18
3.3.1 Connecting antennas	
3.3.2 Connecting a USB mass storage device	
3.3.3 Connecting other additional device	
3.4 Using AC power	18

---

## 4. Preparation

4.1 Setting clock	19
4.1.1 Viewing clock	
4.2 Using the remote control	20
4.2.1 Inserting batteries into the remote control	
4.3 Using navigation controls	20
4.4 Using alphanumeric keys	20

---

## 5. Basic functions

5.1 Switching to standby/on and selecting functions	21
5.2 Switching to power-saving mode	21
5.3 Auto-standby	22
5.4 Volume control	22
5.5 MUTE	22
5.6 Sound control	22-23
5.7 Display adjustment	23
5.8 Selecting languages	23

---

## 6. HD

6.1 Playing Harddisk (HD)	24
6.2 Selecting and searching	25-26
6.2.1 Selecting a different option	
6.2.2 Searching by key words	
6.2.3 Selecting tracks of a particular artist	
6.2.4 Selecting tracks of a particular genre	
6.2.5 Selecting a track in current album during playback	
6.2.6 Finding a passage within current track during playback	
6.3 Different play modes:	
REPEAT, SHUFFLE	26
6.4 SMART EQUALIZER	26
6.5 Viewing track information	27
6.6 Moving music playback between Center and Stations	27-28
6.6.1 MUSIC FOLLOWS ME	
6.6.2 MUSIC BROADCAST	
6.7 Viewing system information	28

---

## 7.0 FM radio

7.1 Tuning to radio stations	29
7.2 Storing preset radio stations	29-30
7.2.1 Autostore: automatic programming	
7.2.2 Manual programming	
7.2.3 To listen to a preset station	
7.3 RDS	30
7.4 NEWS	30
7.4.1 Activating NEWS	
7.4.2 Deactivating NEWS	

---

## 8. External sources

8.1 Playing or recording to USB mass storage device	31-32
8.1.1 About the USB device	
8.1.2 Playing music from the USB device	
8.2 Playing other external sources	32

---

## 9. UPnP (Universal Plug and Play)

- 9.1 About UPnP \_\_\_\_\_ 33
  - 9.1.1 About the UPnP-enabled device
- 9.2 Connecting to the UPnP device — 33
- 9.3 UPnP playback \_\_\_\_\_ 33
  - 9.3.1 Playing music from the UPnP device

---

## 10. Sleep \_\_\_\_\_ 34

---

### 11. Alarm

- 11.1 Setting alarm \_\_\_\_\_ 35
  - 11.1.1 Setting alarm time
- 11.2 Activating/ deactivating alarm — 35
  - 11.2.1 Stopping alarm sound
  - 11.2.2 Activating/ deactivating alarm

---

### 12. Network setting

- 12.1 Adding Additional Station to the Wi-Fi network on the Center \_\_\_\_\_ 36
- 12.2 Connecting to external Wi-Fi network \_\_\_\_\_ 37
  - 12.2.1 Network setting on Station
- 12.3 Connecting to external wired network \_\_\_\_\_ 38
  - 12.3.1 Network setting on Station
- 12.4 Viewing the connection with external network \_\_\_\_\_ 39

---

## 13. Reset \_\_\_\_\_ 40

---

## 14. Firmware Upgrade \_\_\_\_\_ 41

- 14.1. Firmware upgradeing \_\_\_\_\_ 41

---

## 15. Troubleshooting \_\_\_\_\_ 42-43

---

## 16. Appendix

- How to mount your Station onto walls \_\_\_\_\_ 44

# 1. General information

---

## 1.1 About WAS7000

Up to 5 **WAS7000** Stations can be connected to a **WAC7000** Center.

You can centrally store up to 1500 audio CDs in the 80GB hard disk on WAC7000. All stored music will then be wirelessly streamed from the Center to the connected Stations via Wi-Fi\*\*. Your music enjoyment will no longer be restricted by the location of your CD player or PC, nor the messy wiring. With WAS7000, you will have the freedom to enjoy your favorite music anywhere at home.

\*\* Wi-Fi, or IEEE802.11 b/g, is the international leading industry standard for wireless broadband networking. Digital data will be transferred with wider range and bandwidth.

---

## 1.2 Supplied accessories

- Remote control with 2 x AA batteries
- 1 x FM wire antenna
- 1 x Ethernet cable
- 1 x PC Suite CD
- 1 x Mounting kit

***This set complies with the radio interference requirements of the European Community.***

***Philips Consumer Electronics, BG Entertainment Solutions, hereby declares that this product WAS7000 is in compliance with the essential requirements and other relevant provisions of Directive 1999/5/EC.***

***The making of unauthorized copies of copy-protected materials, including computer programs, files, broadcasts and sound recordings, may be an infringement of copyrights and constitutes as a criminal offence. This equipment should not be used for such purposes.***



## 1.3 Philips on-line support

Products from Philips have been designed and manufactured to the highest quality standards. If your Philips "Connected Planet" product is not working correctly, we recommend that you check the User Manual to verify that your product has been properly connected and configured.

To enhance your home entertainment experience, our Connected Planet support website ([www.philips.com/support](http://www.philips.com/support)) offers you all the information you need to fully enjoy your product as well as the new additions to our exciting range of products.

Please visit: [www.philips.com/support](http://www.philips.com/support) and enter your product name (WAS7000) to view:

- FAQ (Frequently Asked Questions)
- Latest user manuals and PC software manuals
- Firmware upgrade files for WAS7000
- Latest PC software downloads
- Interactive troubleshooting

As it is possible for you to upgrade your product, we recommend that you register your product on [www.club.philips.com](http://www.club.philips.com) so that we can inform you as soon as new and free upgrades are available.

Enjoy your **WAS7000!**

# 1. General information

## 1.4 Environmental information

All redundant packaging material has been omitted. We have done our utmost to make the packaging easily separable into three mono materials: cardboard (box), polystyrene foam (buffer) and polyethylene (bags, protective foam sheet).

The set consists of materials which can be recycled if disassembled by a specialised company. Please observe the local regulations regarding the disposal of packaging materials, exhausted batteries and old equipment.

### Disposal of your old product

**Your product is designed and manufactured with high quality materials and components, which can be recycled and reused.**



**When this crossed-out wheeled bin symbol is attached to a product it means the product is covered by the European Directive 2002/96/EC**

**Please inform yourself about the local separate collection system for electrical and electronic products.**

**Please act according to your local rules and do not dispose of your old products with your normal household waste. The correct disposal of your old product will help prevent potential negative consequences for the environment and human health.**

## 1.5 Maintenance

### Cleaning the Set

- Use a soft cloth slightly moistened with a mild detergent solution. Do not use any solutions that contain alcohol, spirits, ammonia or abrasives.

## 1.6 Safety information

- Place the set on a flat, firm and stable surface.
- Keep the system, batteries or discs away from excessive moisture, rain, sand or any heat sources, such as heating equipment or direct sunlight.
- Place the set in a location with adequate ventilation to prevent internal heat build-up in your system. Allow at least 10 cm (4 inches) clearance from the rear and the top of the unit and 5 cm (2 inches) from each side.
- Never cover the ventilation openings with items such as newspapers, table-cloths, curtains, etc as this will impede ventilation.
- Never expose the set to water dripping or splashing.
- Never place objects filled with liquids, such as vases, on the set.
- Never place sources of naked flame, such as lighted candles on the set.
- The mechanical parts of the set contain self-lubricating bearings and must not be oiled or lubricated.

### **CAUTION**

***Visible and invisible laser radiation. If the cover is open, do not look at the laser beam.***

***High voltage! Do not open. You run the risk of getting an electric shock.***

***The set does not contain any user-serviceable parts.***

***Modification of the product could result in hazardous EMC radiation or other unsafe operations.***

***Use of controls or adjustments or performance of procedures other than herein may result in hazardous radiation exposure or other unsafe operation.***

# 2. Controls

English

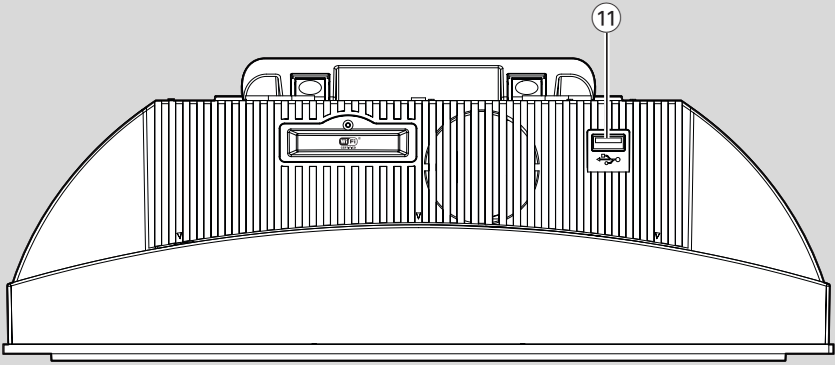
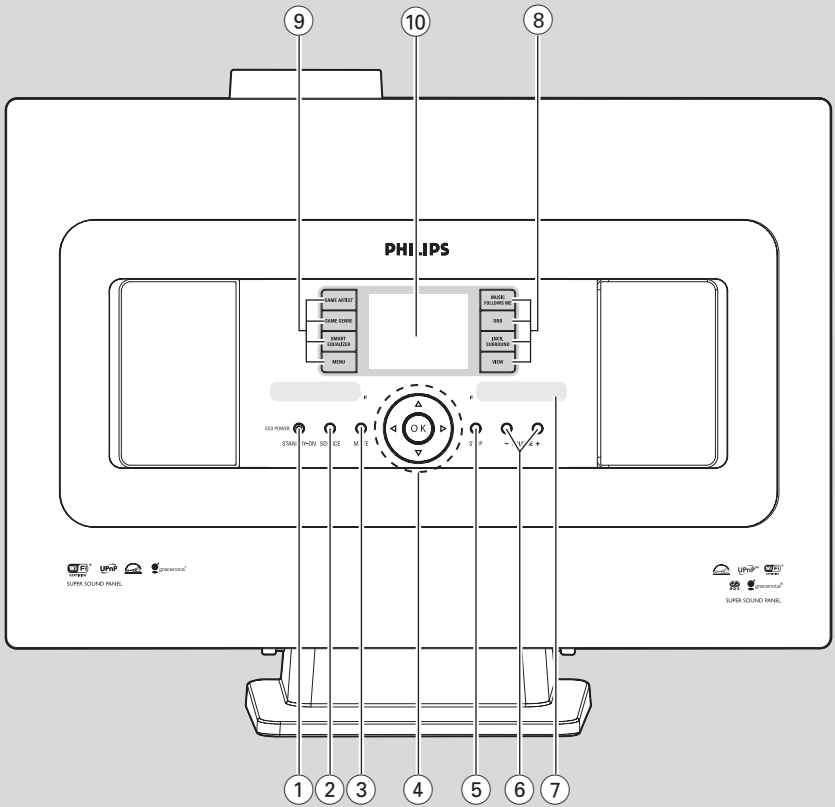

## 2.1 Controls on the Station (Top and front panels)

- ① **STANDBY-ON/ ECO POWER**
  - press briefly to switch the set on or to standby mode;
  - press and hold to switch the set to power-saving mode or on
  - **Green indicator:** lights up green when the set is on
  - **Red indicator:** lights up red when the set is switched to standby mode or power-saving mode
- ② **SOURCE**
  - selects sound source **HD**(hard disk), **Radio**, **USB**, **UPnP** or **AUX**
  - **In standby mode:** switches the set on and selects sound source **HD**, **Radio**, **USB**, **UPnP** or **AUX**
- ③ **MUTE**
  - switches the sound off temporarily
- ④ **◀ / ▶ / ▲ / ▼**
  - navigation controls (left, right, up, down) to scroll through the option list
  - **HD/USB/UPnP:** returns to previous option lists
  - **Radio:** enters the list of preset stations
  - **▲ / ▼**
  - **HD/USB/UPnP:** skips/searches tracks/passage backward/forward (in playback screen); fast scrolls the option list
  - **Radio:** tunes to radio stations
- OK**
  - confirms selection
- ⑤ **STOP**
  - stops playback
- ⑥ **VOLUME -, +**
  - adjusts the volume level
- ⑦ **IR**
  - sensor for the infrared remote control
- Helpful hints:**
  - *Always point the remote control towards this sensor.*

- ⑧ **MUSIC FOLLOWS ME**
  - **HD:** moves music playback between Center and Station or between Station and Station
- MUSIC BROADCAST**
  - **HD:** broadcasts music from the Center to the Station
  - **DBB (DYNAMIC Bass Boost)** turns the bass enhancement on (DBB1, DBB2, DBB3) or off
- INCR. SURROUND**
  - selects surround sound effect
- VIEW**
  - toggles playback display and previous option list
  - press and hold to view clock
- ⑨ **SAME ARTIST**
  - **HD:** plays all the tracks of current Artist
  - **HD:** enable Wireless Range Extender (refer to Extender's manual for details)
- SAME GENRE**
  - **HD:** plays all the tracks of current Genre
- SMART EQUALIZER**
  - **HD:** selects the matched sound setting for current Genre
- MENU**
  - enters or exits setup menu
- ⑩ **Display**
  - shows status of the set
- ⑪ 
  - jack for the external USB mass storage device

## 2. Controls

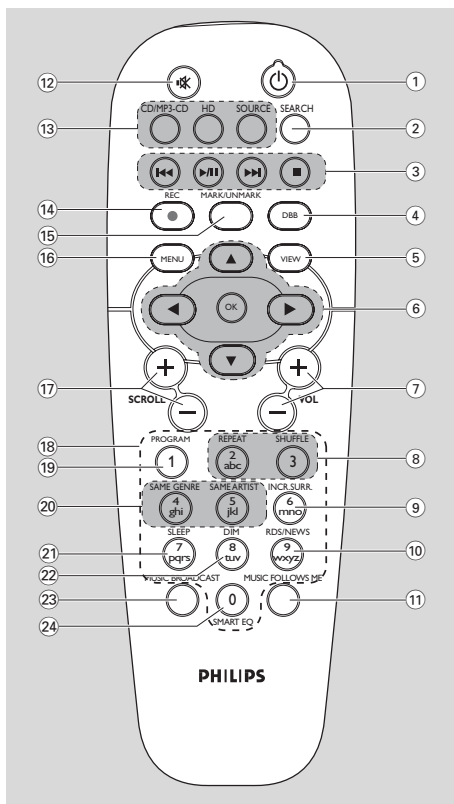





















### 2.2 Station's remote control

- ① **⏻**
  - press briefly to switch on the set or to put it on standby mode;
  - press and hold to switch the set to power-saving mode
- ② **SEARCH**
  - searches by keywords
- ③ **⏮ / ⏭**
  - skips/searches tracks/passage backward/forward (in playback screen)
  - ⏮**
  - **Text input:** deletes the input before cursor
  - ⏭**
  - starts or pauses playback
  - 
  - stops playback

- ④ **DBB (Dynamic Bass Boost)**
  - turns the bass enhancement on (DBB1, DBB2, DBB3) or off
- ⑤ **VIEW**
  - toggles playback screen and previous option list
- ⑥ **⏪ / ⏩ / ▲ / ▼**
  - navigation controls (left, right, up, down) to scroll through the option list
  - ⏪**
  - **HD/USB/UPnP:** returns to previous option lists
  - **Radio:** enters the list of preset stations
  - **Text input:** moves the cursor backward
  - ▲ / ▼**
  - **HD/USB/UPnP:** skips/searches tracks/passage backward/forward (in playback screen); fast scrolls the option list
  - **Radio:** tunes to radio stations
  - ▶**
  - confirms selection
  - **Text input:** confirms input and moves the cursor forward
  - OK**
  - Confirm selection
  - Starts playing
- ⑦ **VOL +, -**
  - adjusts the volume level
- ⑧ **REPEAT**
  - selects continuous playback
- SHUFFLE**
  - selects random playback
- ⑨ **INCR. SURR.**
  - selects surround sound effect
- ⑩ **RDS/NEWS**
  - **Radio:** selects RDS information
  - **HD/UPnP/AUX:** turns NEWS function on or off
- ⑪ **MUSIC FOLLOWS ME**
  - **HD:** moves music playback between Center and Station
- ⑫ **MUTE**
  - switches the sound off temporarily

- ⑬ **CD/MP3-CD**  
(works with WAC7000 Center only)  
**HARDDISK (HD)**
  - selects HD (hard disk) source
  - **In standby mode:** switches the set on and selects HD source**SOURCE**
  - selects Radio source, UPnP source, USB source or AUX from an additional connected appliance
  - **In standby mode:** switches the set on and selects Radio source, USB source, UPnP source or the audio input from an additional connected appliance
- ⑭ **REC**(works with WAC7000 Center only)
- ⑮ **MARK/UNMARK**  
(works with WAC7000 Center only)
- ⑯ **MENU**
  - enters or exits setup menu
- ⑰ **SCROLL + -**
  - scrolls the display screen upward or downward
- ⑱ **Alphanumeric keys**
  - for text input
- ⑲ **PROGRAM**
  - **Radio:** manually programs preset radio stations
- ⑳ **SAME GENRE**
  - **HD:** plays all the tracks of current Genre**SAME ARTIST**
  - **HD:** plays all the tracks of current Artist
  - **HD:** enable Wireless Range Extender (refer to Extender's manual for details)
- ㉑ **SLEEP**
  - adjusts/displays/switches off sleep timer
- ㉒ **DIM**
  - changes the brightness of display illumination
- ㉓ **MUSIC BROADCAST**  
(works with WAC7000 Center only)
- ㉔ **SMART EQ**
  - **HD:** selects the sound settings that matches the current Genre

## 2.3 Icons on LCD display

Icon	Description
	Client connected
	Client not connected
	Music
	Radio
	UPnP
	Aux mode
	HD mode
	Radio mode
	USB mode
	Repeat all
	Repeat 1
	Shuffle
	Alarm
	Music Broadcast
	Music follow me
	Mute
	News
	Sleep
	Smart EQ
	WiFi connected
	Both WiFi and Ethernet connected

# 3. Installation

## 3.1 Place Station

With detachable stand and by-packed wall mounting kits, WAS7000 Station allow you to place them in two ways: on desktops with stand or on wall without stand.



(on desktop with stand)  
or

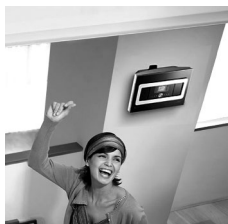

(on wall without stand)

To learn more about wall mounting, see Appendix: How to mount your Station onto wall.

### IMPORTANT!

- Before you decide where and how to place your Station, try the Wi-Fi connection and rear connections to find a suitable location.

## 3.2 Setting up Wi-Fi connection between Center and Station

You can add a station to an existing Wi-Fi network of Center and Station. Up to 5 WAS7000 stations can be connected to a WAC7000 Center:

- 1 The first time you set up a Wi-Fi connection, place the Center and Station side by side on a flat and firm surface.
- 2
  - a. Connect the Center to power supply
  - b. Connect the Station to power supply
  - Auto installation/connection starts
  - HD screen appears on the Center
  - HD screen appears on the Station when the Station is connected to the Center
- 3 Unplug the Center and Station. Relocate as desired.

### IMPORTANT!

- Make sure that you have already powered up the Center before powering up the Station.
- Avoid installing between thick walls. The Center and Station should never be blocked by 2 or more walls.
- Avoid placing the system near to large metal objects.
- For better Wi-Fi reception, turn the Wi-Fi antenna, or adjust the location of the Center and Station.
- Always press and hold **STANDBY-ON**  to switch the set to **ECO POWER** (power-saving mode) before removing its power plug.



## 3. Installation

### 3.3 Rear connections

#### Warning:

– **Never make or change the connections when the mains is switched on.**

#### 3.3.1 Connecting antennas

- 1 Extend the wire antenna and fit it to the **FM ANTENNA** as shown below

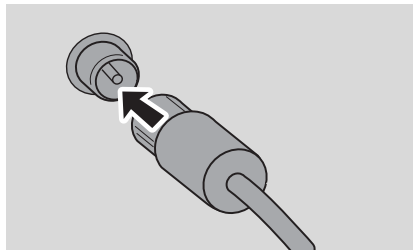

- 3 (Optional) To improve FM reception, fit the plug of the wire antenna into the plug of the extension line (sold separately) as shown below
- 3 Extend the extension line and move it in different positions for optimal reception (as far away as possible from the TV/VCR or other radiation sources)
- 4 Fix end of the extension line to the ceiling

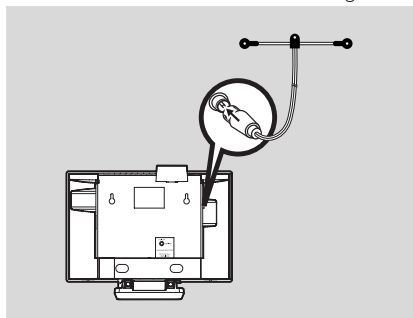

#### 3.3.2 Connecting a USB mass storage device

On Station, you can playback music from a USB mass storage device.

- 1 Insert the USB device's USB plug into the socket  on the Station

#### For the devices with USB cable:

- Insert one plug of the USB cable (not supplied) to the socket  on the Station
- Insert the other end of the USB cable into the USB output terminal of the USB device

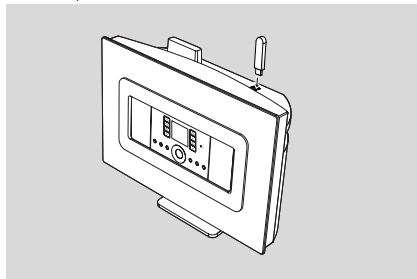

- 3 To playback music from the USB device, press **SOURCE** once or more times to select USB source (see External source)

#### Helpful hints:

The Station only supports USB devices that adhere to the following standards:

- USB MSC (Type '0')
- File system in FAT12/ FAT16/ FAT32
- Operations based on simple folder based navigation (also known as a normal FAT file system), and not based on proprietary track database.

The following USB devices will not be supported by the Station:

- MTP based or Dual mode (adhering to both the MSC and MTP standards) devices, as the Station does not support browse, play and export functions using the MTP protocol.
- Products with database based UI (Artists, Albums and Genre based navigation) as these products normally store music files in a specific hidden folder and uses embedded proprietary track database that the Station is unable to read properly.

# 3. Installation

## 3.3.3 Connecting to other additional devices

It is possible to play audio output from an external source, e.g. TV, VCR, Laser Disc player, DVD player on the Station.

### On the additional device

- 1 Connect one end of the audio cable (not supplied) to the **AUDIO OUT** terminals on the additional device

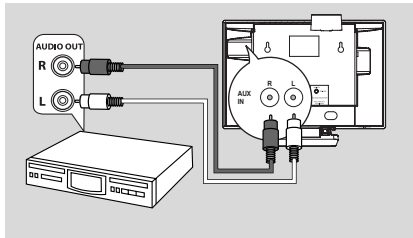

### On the Station

- 2 Connect the other end of the audio cables to the **AUX IN** terminals on the Station
- 3 To playback audio output from the additional device, press **SOURCE** to select AUX mode on the Station (see **External source**)

### Helpful hints:

- If the connected device has only a single audio out terminal, connect it to the AUX IN left terminal. Alternatively, you can use a “single to double” cinch cable, but the output sound still remains as mono.
- Always refer to the owner’s manual of the other equipment for complete connection.

## 3.4 Using AC power

- 1 Make sure that all connections have been made before switching on the power supply
- 2 Connect the AC power cord to the wall socket. This switches on the power supply

When the Station is switched to standby mode, they will still be consuming some power. **To disconnect the system from the power supply completely, remove the power plug from the wall socket.**

### Helpful hint:

- Always press and hold **STANDBY-ON** to switch the set to **power-saving mode** before removing its power plug.

**The rating label is located on the backside of the set.**

**For users in the U.K.: please follow the instructions on page 2.**

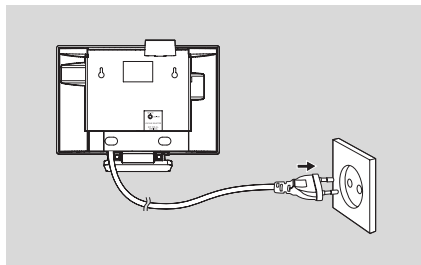

## 4.1 Setting clock

The time can be displayed in 24-hour or 12-hour format.

- 1 Press **MENU** to enter the menu screen.

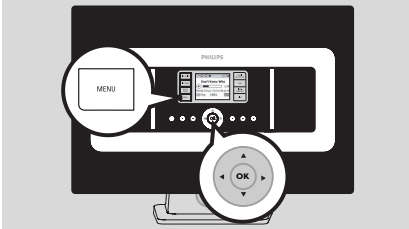

- 2 Use the navigation controls ▲ or ▼ and ► to select Settings followed by Time



- 3 To set clock time,
  - a. Press the navigation controls ▲, ▼ or Numeric Keypad (0-9) and ► to select Set Time
    - The display shows current clock setting (00:00 by default)
  - b. Press the navigation controls ▲, ▼ or Numeric Keypad (0-9) repeatedly to set the hour followed by the minute.

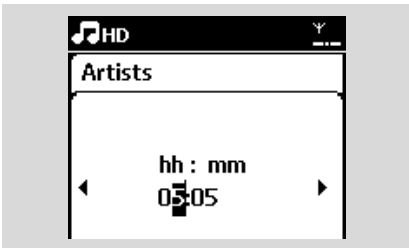

- c. Press **OK** to confirm the clock setting.

### Helpful hints:

To change to 12-hour or 24-hour format

- In the Time menu, select Time Format (see the above Step 2)
- Press ▲ or ▼ and ► to select your option.
- The clock setting will not be saved when the set is disconnected from the power supply.

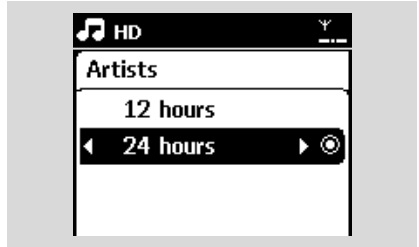

### 4.1.1 Viewing clock

Press and hold **VIEW** button for about 5 seconds.

→ Clock will be shown briefly on the display.

### Helpful hint:

- In standby mode, you may press View button briefly to turn on the LCD backlight so as to view clock clearly.
- Reset clock if the power cord is plugged off.

# 4. Preparation

## 4.2 Using the remote control

### IMPORTANT!

- The remote control might not be able to operate the other wireless music systems from Philips (e.g. WACS700, WACS5)
- Always point the remote control directly towards the IR sensor on the Station you wish to operate.

### 4.2.1 Inserting batteries into the remote control

- 1 Open the battery compartment
- 2 Insert 2 batteries (type R06 or AA) into the remote control with the correct polarity (as indicated by the "+" and "-" symbols inside the battery compartment)

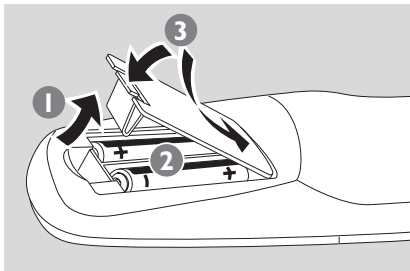

- 3 Replace the compartment door

### CAUTION!

- Remove the batteries when they are exhausted or when the remote control will not be used for a long time.
- Do not use old and new or different types of batteries together.
- Batteries contain chemical substances, hence they should be disposed of properly.

## 4.3 Using navigation controls

When selecting options on the set, you often need to use the navigation controls ◀/▶/▲/▼

- 1 Press ▲ / ▼ to highlight an option.
- 2 Enter its submenu by pressing ▶
- 3 Press ◀ to return to the previous option list
- 4 Press OK or ▶ to confirm

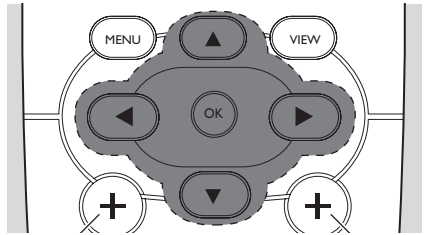

## 4.4 Using alphanumeric keys

Use the alphanumeric keys to input letters or numbers.

- 1 When the text box appears, press the alphanumeric keys repeatedly until the desired letter/number appears (maximum 8 characters)

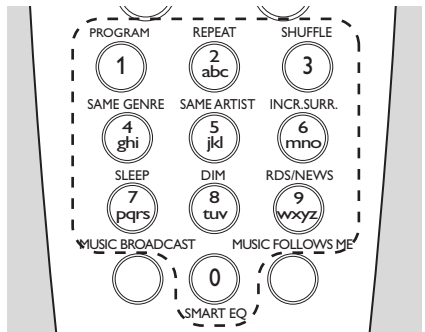

- 2 Press ◀ / ▶ to move the cursor backward / forward  
**Helpful hint:**
  - You will enter the previous/next option list if the cursor reaches the beginning or end of the text box.
- 3 Press I◀◀ to delete the entry before the cursor.
- 4 Press OK to close the text box and move to the next option list.

## 5. Basic functions

### 5.1 Switching to standby/on and selecting functions

- 1 When the set is switched on, press **STANDBY-ON/ ECO POWER** to switch it to standby mode (or press  on the remote control)
  - The Red indicator lights up
  - Display shows the connected or previously connected Center
    - The screen will remain empty if no Center is found
    - The time will be displayed.—:— appears if you have not set the clock
- 2 To switch on, press **STANDBY-ON/ ECO POWER** on the set
  - The set switches to the last source selected
  - The Green indicator lights up

**OR**

Press the source button on the remote control (e.g. **HD, SOURCE**)
- 3 To select functions, press **SOURCE** once or more times (or press **HD, SOURCE** on the remote control)

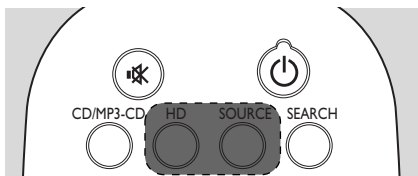

**Helpful hint:**

- *CD/MP3-CD source is only available on the Center.*

### 5.2 Switching to power-saving mode

In power-saving mode, the set's display and Wi-Fi connection are turned off

- 1 When the set is on, press and hold **STANDBY-ON/ ECO POWER** to switch it to power-saving mode (or press and hold  on the remote control).
  - The Red indicator lights up
  - The display is switched off

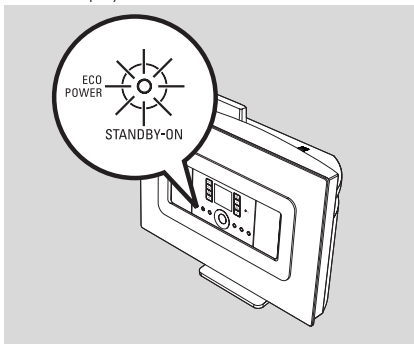

- 2 To switch on, press **STANDBY-ON/ ECO POWER**.
  - The set switches to the last source selected

**Helpful hints:**

- *In power-saving mode, the networking, sound, display, language, the tuner presets, and the volume level (maximum: the moderate level) will be retained in the set's memory.*

# 5. Basic functions

## 5.3 Auto-standby

When the set has reached the end of playback and remains in the stop position for more than 20 minutes, the set will switch to standby mode automatically to save power.

## 5.4 Volume control

- 1 Check that playback has started
- 2 Adjust the volume with **VOL +/-** buttons  
→ Display shows the volume bar; indicating the volume level

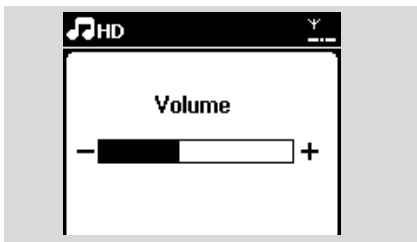

## 5.5 MUTE

During playback, you can temporarily switch off the sound without switching off the set.

- 1 Press **MUTE** to switch off the sound.  
→ The icon appears. Playback continues without sound.
- 2 To switch on the sound, press **MUTE** again or adjust the volume with **VOL +**.  
→ The icon disappears

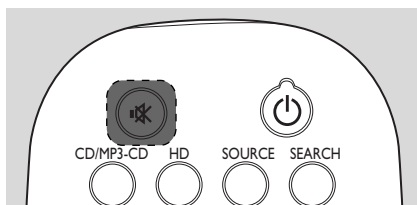

## 5.6 Sound control

### 5.6.1 Equalizer

Equalizer enables you to select predefined sound settings.

- 1 Press **MENU** to enter the menu screen
- 2 Use the navigation controls **▲** or **▼** and **▶** to select Equalizer:



- 3 Press **▲** or **▼** and **▶** to select Rock, Pop (default), Jazz, Neutral, Techno, Classical or Bass/Treble
- 4 Press **OK** (or **▶**) to confirm

### To set Bass/Treble:

- 1 Press **MENU** to enter the menu screen
- 2 Use the navigation controls **▲** or **▼** and **▶** to select Settings
- 3 Press **▲** or **▼** and **▶** to select Treble/Bass
- 4 Press **◀/▶** / **▲/▼** to select your option: Treble (+3 to -3), Bass (+3 to -3)

### 5.6.2 Bass adjustment

- Press **DBB** (Dynamic Bass Boost) once or more times to select your option: DBB OFF (by default), DBB 1, DBB 2 or DBB 3.

## 5. Basic functions

### 5.6.3 Incredible surround

- Press **INCR. SURR.** once or more times to toggle the surround sound effect on or off  
→ Display shows IS ON or IS OFF

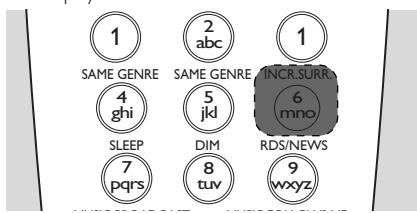

### 5.7 Display adjustment

You can adjust the backlight and contrast settings of the display.

- 1 Press **MENU** to enter the menu screen
- 2 Use the navigation controls ▲ or ▼ and ► to select Settings.
- 3 Press ▲ or ▼ and ► to select Display
- 4 Press ◀ / ▶ / ▲ / ▼ to select your option:

#### Backlight

Press ▲ or ▼ and ► to select On or Off

#### Contrast:

Press ▲ or ▼ to increase or reduce the contrast

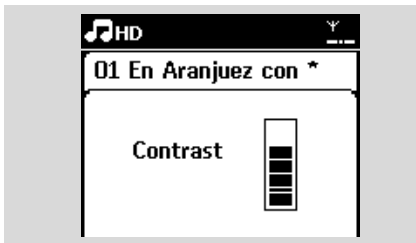

#### Helpful hint:

– You can also toggle the Backlight on or off by pressing DIM on the remote control.

### 5.8 Selecting languages

- 1 Press **MENU** to enter the menu screen
- 2 Use the navigation controls ▲ or ▼ and ► to select Settings
- 3 Press ▲ or ▼ and ► to select Language
- 4 Press ▲ or ▼ and ► to select from: English, Français, Español, Nederlands, Italiano or Deutsch.

# 6.HD(Located on Center)

## 6.1 Playing Hard Disk (HD)

Music is centrally stored in the 80GB hard disk on the WAC7000 Center. All the stored music can be streamed and played on the Station via Wi-Fi.

- 1 Check that the set is switched on  
**IMPORTANT:** also check that the Center is switched on or in standby mode
- 2 Press **SOURCE** once or more times to select HD (or press **HD** on the remote control)  
→ Display shows HD and the categories of your music library: **Playlists, Artists, Albums, Genres, All tracks.**

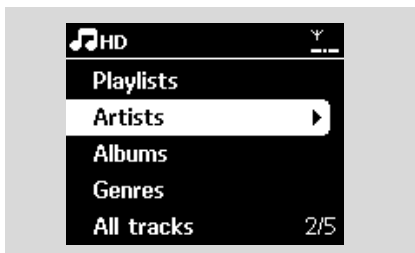

**Playlists:** collection of your favorite tracks sorted by the name of the playlists in alphanumeric order

**Artists:** collection of albums sorted by artist name in alphanumeric order

**Albums:** collection of albums sorted by album name in alphanumeric order

**Genres:** collection of albums sorted according to music style

**All tracks:** tracks sorted by track name in alphanumeric order

- 3 Press the navigation controls ▲ or ▼ and ► to select your option
- 4 Press ►|| to start playback
- Press ►|| on a highlighted artist, genre or album to start playback from the beginning of the item

- The playback screen appears:
  - on the top:** HD
  - in the middle:** current track name and some track information
  - at the bottom:** elapsed playing time and total playing time

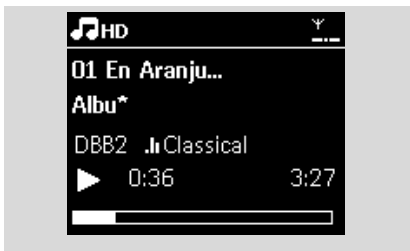

- 5 To pause playback, press ►|| To resume playback, press the button again
- 6 To stop playback, press **STOP ■**

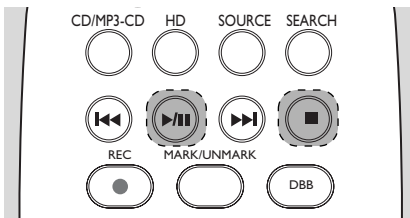



# 6.HD(Located on Center)

## 6.2 Selecting and searching

### 6.2.1 Selecting a different option

- 1 If necessary, press ◀ repeatedly to enter previous option lists
- 2 Press the navigation controls ▲ or ▼ repeatedly and ▶ to select the option
- 3 Press **VIEW** to return to the playback screen, if necessary

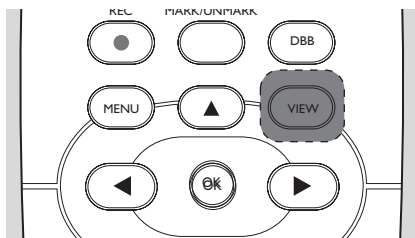

### 6.2.2 Searching by keywords

The keyword should be the first letter or word of the title of the track you wish to search for. By inputting a keyword, you can quickly find all the items containing the word (note that it is case sensitive)

- 1 Use the navigation controls ◀/▶/▲/▼ to enter the desired option list of tracks, albums, artists or playlists
- 2 On the remote control, press **SEARCH**  
→ A text box appears on the display

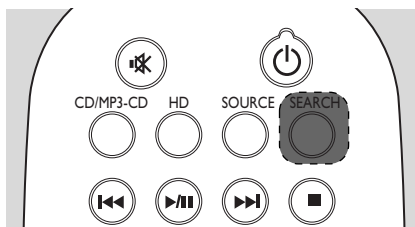

- 3 Use the **alphanumeric keys** to input the key words (maximum 8 characters) (see Preparation: Using Alphanumeric Keys )

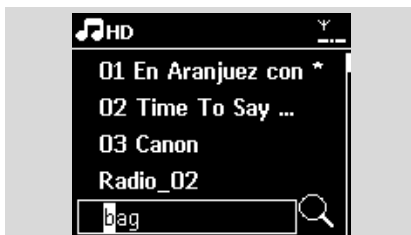

- 4 Press **OK** to start searching  
→ Display shows: Searching ... Searching starts from the beginning of current option list  
→ The matched items appear at the top of the list  
→ The option list remains unchanged if no match is found. Searching ... disappears
- 5 Press **STOP** ■ to stop searching

#### Helpful hints:

- The searching will also stop when:
  - you select another source
  - you switch off the set
- If no match is found during the keyword search, press ◀◀ or ▶▶ on the remote control to find close matches.
- In HD mode, please enter the second level (any folder) to search.

# 6.HD(Located on Center)

## 6.2.3 Selecting tracks of a particular artist

- 1 During playback, press **SAME ARTIST**  
 → Playback of tracks by the current artist continues after current track.

## 6.2.4 Selecting tracks of a particular genre

- 1 During playback, press **SAME GENRE**  
 → Playback of tracks with the same genre as the current track continues after the current track.

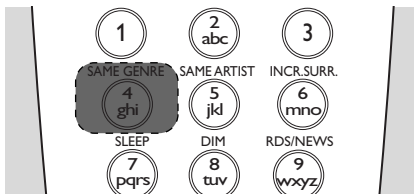

## 6.2.5 Selecting a track in the current album during playback

- 1 In the playback screen, press the navigation controls ▲ or ▼ briefly and repeatedly to select previous or next tracks (or ◀◀ or ▶▶ on the remote control)

## 6.2.6 Finding a passage within the current track during playback

- 1 In the playback screen, press and hold the navigation controls ▲ or ▼ (or ◀◀ or ▶▶ on the remote control)  
 → The track plays at a high speed
- 2 When you recognize the passage you want, release ▲ or ▼ (or ◀◀ or ▶▶ on the remote control)  
 → Normal playback resumes.

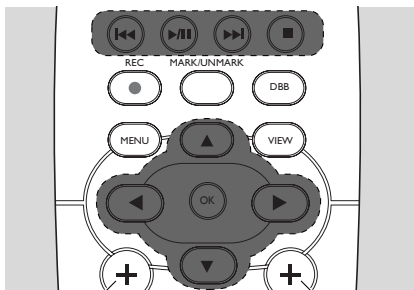

## 6.3 Different play modes: REPEAT, SHUFFLE

– plays the current track continuously

– repeats all the tracks (under current Artist, Genre or Album)

– repeats all the tracks (under current artist, genre or album) in random order

– tracks (under current artist, genre or album) are played in random order

- 1 During playback, press **REPEAT** or/and **SHUFFLE** once or more times to select play modes
- 2 To return to normal playback, press **REPEAT** or/and **SHUFFLE** repeatedly until the various modes are no longer displayed

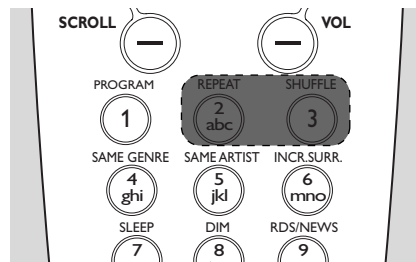

## 6.4 SMART EQUALIZER

This function enables you to playback music of the current genre with the matched sound settings.

- During playback, press **SMART EQUALIZER**  
 → The icon appears if SMART EQUALIZER is activated
- To deactivate SMART EQUALIZER, adjust the sound settings (DBB, Incr. Surr. or Equalizer)  
 → The icon disappears

## 6.HD(Located on Center)

### 6.5 Viewing track information

- 1 Press **VIEW** on the remote control once or more times to enter the playback screen.

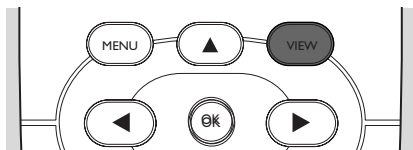

- 2 Press **▶**  
→ The display shows the track information (e.g. track name, file type, file size, bit rate of mp3/wma files)



- 3 Press **VIEW** once or more times to return to the playback screen

### 6.6 Moving music playback between Center and Stations

Via Wi-Fi, music playback can be moved between the Center and Stations. Even in different parts of your home, you and your family will still be able to enjoy and share music with ease.

#### 6.6.1 MUSIC FOLLOWS ME

As you move around at home, let the music move with you between the Center and Station or between Stations.

#### On the source unit (Center or Station) where music is playing:

- 1 In HD source, select and play the album or playlist you wish to play on the destination unit (see HD: Selecting and searching)

#### Helpful hints:

- Press **▶||** to interrupt playback if you want the playback to continue from where it has paused on the destination unit.
- The selected play modes (e.g. **REPEAT** **SHUFFLE**) will be retained on the destination unit (see Different play modes: REPEAT, SHUFFLE).

- 2 Press **MUSIC FOLLOWS ME** to activate  
→ The icon appears

#### Helpful hints:

- **MUSIC FOLLOWS ME** will be automatically deactivated if you do not activate **MUSIC FOLLOWS ME** on the destination unit within 5 minutes
- To deactivate **MUSIC FOLLOWS ME**, press **MUSIC FOLLOWS ME** again or press other function keys (e.g. **SLEEP** or **◀/▶/▲/▼**)

#### On the destination unit (Center or Station), where the music will continue:

- 3 Check that the destination unit is switched on or is already in standby mode
- 4 Press **MUSIC FOLLOWS ME**  
→ Playback of selected music stops on the source unit and continues on the destination unit  
→ The icon disappears
- 5 To stop **MUSIC FOLLOWS ME**, press **STOP** on the destination unit

#### Helpful hints:

- After activating **MUSIC FOLLOWS ME** on the destination unit:
- make sure that the source unit is switched on or is already in standby mode.
  - you can select other tracks or source for playback.

# 6.HD(Located on Center)

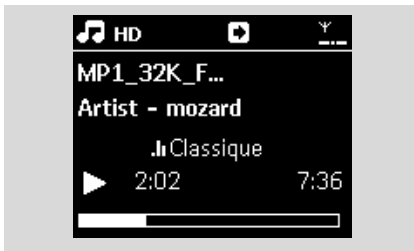

## 6.6.2 MUSIC BROADCAST

MUSIC BROADCAST allows you to broadcast music from Center to Stations.

### On the Stations

- 1 Check that the Station is switched on or is already in standby mode (see Basic functions)

### On the Center

- 2 In HD source, select and play the album or playlist that you wish to broadcast to the Stations (see HD: Selecting and searching)
- 3 Press **MUSIC BROADCAST** to activate

→ The icon  appears on the Center and Stations. A 5-second countdown starts.

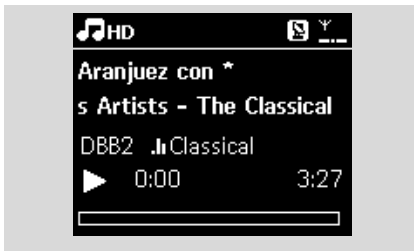

→ On the Center and Stations: The selected music starts to play simultaneously after the 5-second countdown.



- 4 To stop MUSIC BROADCAST, press **STOP** on the Center

### Helpful hints:

- To exit MUSIC BROADCAST on a Station, press **STOP** on the Station. To broadcast music to the Station again, press **STOP** on the Center, and then activate MUSIC BROADCAST on the Center again.
- MUSIC BROADCAST will also stop when:
  - the Center is put to standby mode or power-saving mode;
  - the selected album or playlist has reached the end.

## 6.7 Viewing system information

- 1 Select Information on the Station
  - a. Press **MENU** to enter the menu screen
  - b. Press the navigation controls **▲** or **▼** and **▶** to enter Information menu→ The display shows: System, WiFi and Ethernet

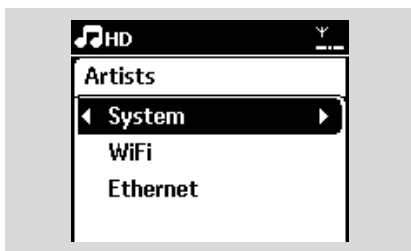

- 2 Press the navigation controls **▲** or **▼** and **▶** to select System  
→ The following information will be shown on the display: the name of the Station, firmware version



## 7.1 Tuning to radio stations

- 1 Connect the supplied FM wire antenna to the Station (see Installation)
- 2 Check that the set is switched on or in standby mode (see Basic functions)
- 3 Press **SOURCE** once or more times to select Radio  
→ Playback screen appears. Display shows: Radio, the radio station frequency and a preset number (if already programmed)
- 4 Press and hold ▲ or ▼ until the frequency in the display starts running.

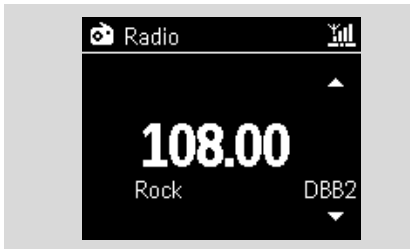

- The radio automatically tunes to a station of sufficient reception. Display shows Searching during automatic tuning
- If a station is received in stereo, (S) is shown
- When you are receiving an RDS station, (DBB2) is shown

- 5 Repeat Step 3 if necessary until you find the desired radio station
- To tune to a weak station, press ▲ or ▼ briefly and repeatedly until optimal reception is detected.

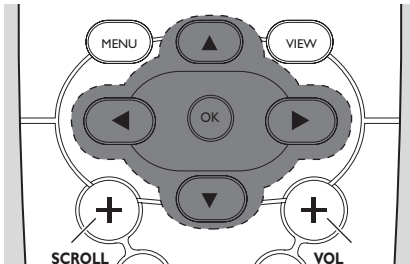

## 7.2 Storing preset radio stations

You can store up to 60 preset radio stations in the memory.

### 7.2.1 Autostore: automatic programming

Autostore automatically starts programming radio stations from Preset 1. Available stations are programmed in the order of radio frequencies: RDS stations followed by FM stations. A maximum of 10 RDS stations will be stored (from Preset 01 to Preset 10).

- 1 To select Autostore radio,
  - a. Press **MENU**
  - b. Use the navigation controls ▲ or ▼ and ► to select Autostore radio  
→ Display shows: Autostore Please wait...  
→ After all the stations are stored, the first autostored preset station will then play automatically.

### 7.2.2 Manual programming

- 1 Tune to your desired radio station (see Tuning to radio stations).
- 2 Press **PROGRAM** on the remote control.  
→ The display shows:

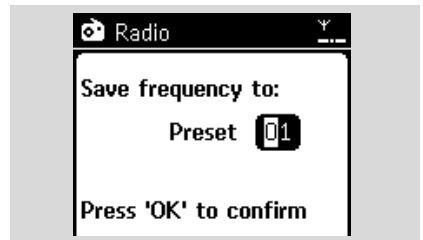
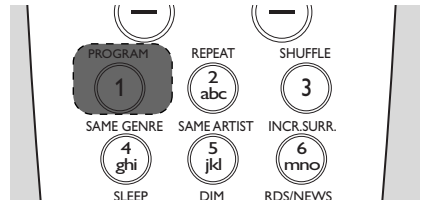

# 7. FM radio

- 3 On the Station, press ▲ or ▼ or the **Numeric Keypad (0-9)** to select your desired preset number.
- 4 Press **OK**  
→ Current radio station is stored to that preset location.

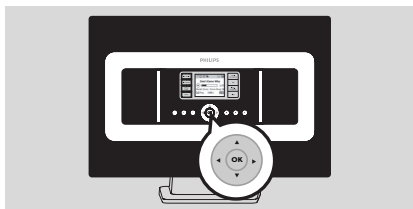

## 7.2.3 To listen to a preset station

- 1 Press ◀ to enter the list of preset stations
- 2 Use the navigation controls ▲ or ▼ followed by ▶ to select the desired station.

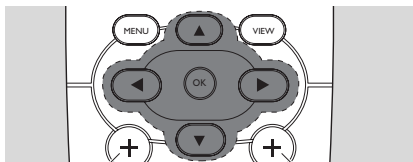

## 7.3 RDS

**RDS (Radio Data System)** is a service that allows FM stations to send additional information along with FM radio signal.

- 1 Tune to the desired RDS radio station (see Autostore: automatic programming).  
→ The display shows the following information (if available):
  - name of the radio station
  - radio frequency
  - program type (for example: News, Pop Music)
  - RDS radio text





## 7.4 NEWS

You can activate NEWS while listening to HD, USB, UPnP, or AUX source on WAS7000. The set will tune to the news radio station if the related signals are received from a RDS station.

### 7.4.1 Activating NEWS

- During playback in HD, USB, UPnP, or AUX source, press **RDS/NEWS** on the remote control.



- The icon  appears and NEWS ON is displayed briefly
- Playback continues when the set scans the first 10 preset stations
- When news transmission is detected, the set will switch to the news station. The icon  starts flashing

### Helpful hints:

- Make sure that you have stored RDS stations in the first 10 preset locations (see Autostore: automatic programming).
- If no news transmission is detected during the scanning of the set, the icon  disappears and NO RDS NEWS is displayed.

### 7.4.2 Deactivating NEWS

- Press **RDS/NEWS** again on the remote control.
- Switch the set to Radio source  
→ The icon  disappears and NEWS OFF is displayed briefly.

## 8.1 Playing USB mass storage device

You can playback music from a USB mass storage device on the Station.

### 8.1.1 About the USB device

#### Compatible USB mass storage devices:

The following devices can be used on the Station:

- USB flash memory (USB 2.0 or USB1.1)
- USB flash players (USB 2.0 or USB1.1)
- Memory cards (requires an additional card reader to work with the Station)

#### IMPORTANT!

– In some USB flash players (or memory devices), the stored contents are recorded using copyright protection technology. Such protected contents cannot be played on any other devices (such as the Station).

– MTP (Media Transfer Protocol) USB devices are not supported.

#### Supported formats:

- USB or memory file format FAT12, FAT16, FAT32 (sector size: 512 - 65,536 bytes)
- MP3 bit rate (data rate): 32-320 Kbps and variable bit rate
- WMA v9 or earlier versions
- Directory nesting up to a maximum of 8 levels
- Number of albums/folders: maximum 99
- Number of tracks/titles: maximum 999
- File name in Unicode UTF8 (maximum length: 256 bytes)

#### The Station will not play or support the following:

- Empty albums: an empty album is an album that does not contain any MP3/WMA files, and hence will not be shown on the display.
- Non-supported file formats are skipped. This means that e.g., Word documents or MP3 files with .doc and .dfl extension are ignored and will not be played.
- WAV, PCM audio files
- DRM protected WMA files
- WMA files in Lossless format and VBR format

#### How to transfer music files from your PC to a USB mass storage device

You can easily transfer your favorite music from your PC to a USB mass storage device just by dragging and dropping your music files.

For a flash player, you will be able to use its music management software for the music transfer:

*However, WMA files cannot be played due to compatibility reasons.*

#### How to organize your MP3/WMA files on the USB mass storage device

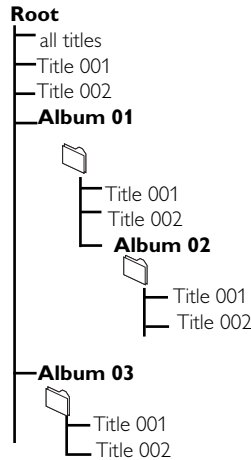

Organize your MP3/WMA files in different folders or sub-folders as needed.

#### Helpful hints:

- “Others” is shown as an album if you have not organized your MP3/WMA files into any albums on your disc.
- Make sure that the file names of MP3 files end with .mp3. and the file names of WMA files end with .wma.
- For DRM protected WMA files, use Windows Media Player 10 (or later) for CD burning/ conversion. Visit [www.microsoft.com](http://www.microsoft.com) for details about Windows Media Player and WM DRM (Windows Media Digital Rights Management)

## 8. External sources

### 8.1.2 Playing music from the USB device

- 1 Check that the USB device is properly connected to the Station (see Installation: Connecting a USB mass storage device )
- 2 Press **SOURCE** once or more times to select USB
  - The icon  appears
    - No USB Device Present appears if the USB device is not supported by the Station
    - File system not supported appears if unsupported file formats are used on the USB device

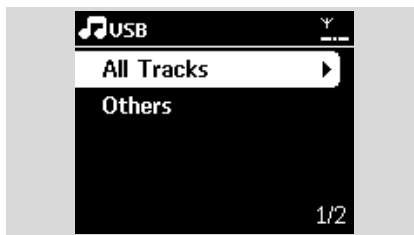

- Empty Folder appears if no audio file is found on the USB device
- 3 Press the navigation controls ▲ or ▼ and ► to select your option
  - 4 Press ►  to start playback

#### **Helpful hint:**

– Due to compatibility reasons, the album/track information may differ from what will be displayed through the flash player's music management software.

### 8.2 Playing other external sources

It is possible to play from an external source on the Station after connecting the audio output, e.g. TV, VCR, Laser Disc player, DVD player:

- 1 Check that the external device is properly connected (see Installation: Connecting other additional devices)
- 2 Check that the Station is switched on or is already in standby mode (see Basic functions).
- 3 On the Station: press **SOURCE** once or more times to select AUX.

- 4 External hard disk audio player:
  - a. turn down the volume to avoid noise distortion.
  - b. press the **PLAY** key to start playback.
- 5 To adjust the sound and volume, use the sound controls on your external device or on WAS7000.



## 9.1 About UPnP\* (Universal Plug and Play)

The music collection on the UPnP-enabled device can be played on the Station, wirelessly or through an Ethernet cable (supplied).

\*Universal Plug and Play (UPnP™) builds on standard networking technologies and provides standardized protocols for a wide variety of home and small business devices. It allows easy interoperability of all the devices supporting the networking technologies.

### 9.1.1 About the UPnP-enabled device

The UPnP device can be a PC or other devices running UPnP software. To use the UPnP device with the Station,

- 1 Connect the Station to the UPnP device's network (see Connecting to the UPnP device)
- 2 To play the music library of your UPnP device on the Station, check that the UPnP server software is properly installed and enabled on the device (e.g. Philips Media Manager in the by-packed PC Suite CD, Musicmatch®, Window Media Connect®)

## 9.2 Connecting to the UPnP device

When connecting to the UPnP device's network, you have the following options:

- 1 Connect wirelessly or through an Ethernet cable
- 2 Connect both the Center and Station, Center only or Station only  
For more information on the connection, see Network setting: Connecting to external Wi-Fi network and Connecting to external wired network.

## 9.3 UPnP playback

In the external Wi-Fi or wired network, music is streamed between devices via UPnP.

### 9.3.1 Playing music from the UPnP device

- 1 Check that the UPnP device is switched on.
  - Switch off the firewall running on the UPnP-enabled PC
- 2 Check that the Station is connected to the UPnP device's network (see Network setting: Viewing connection status)
- 3 On the Station, press **SOURCE** on the remote control to select UPnP mode
  - The display on the set shows a list of connected UPnP devices (up to 4 UPnP devices).



→ Server not found appears if there is no UPnP device found in the network

- 4 Use the navigation controls ▲ or ▼ and ► to select your desired UPnP device
  - The music library of the UPnP device appears on the Station as it does on the UPnP device
- 5 On the Station, play UPnP device's music library in the same way as you play Hard Disk (HD) (see HD).



# 10. Sleep

## 10.1 SLEEP

You can preset a certain period of time after which the Station will switch to standby mode..

- 1 On the remote control, press **SLEEP** repeatedly to select the desired time period (in minutes):
  - The display shows in sequence: Sleep 15, 30, 45, 60, 90, 120, Off.
  - Display shows the selected option briefly and returns to its previous status. The icon **Z<sup>Z</sup>** appears.

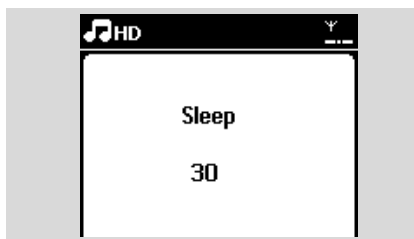

- 2 To view the countdown time to standby mode, press **SLEEP** again
- To deactivate the sleep timer; press **SLEEP** repeatedly until Sleep Off is displayed
- Press **STANDBY-ON/ ECO POWER** to switch the set to standby (or **⏻** on the remote control)

## 11.1 Setting alarm

### IMPORTANT!

Before setting the alarm, check that the clock setting is correct.

### 11.1.1 Setting alarm time

- 1 Enter the alarm setting menu
  - a. Press **MENU**
  - b. Use the navigation controls ▲ or ▼ and ► to select Settings followed by Alarm
- 2 To turn on the alarm
  - a. Press ▲ or ▼ and ► to select Alarm On/Off
  - b. Press ▲ or ▼ and ► to select On  
→ Alarm On appears. The icon  appears.



- 3 In Alarm Time menu, set the alarm time
  - a. Press the navigation controls ▲ or ▼ repeatedly to set the hour followed by the minute
  - b. Press **OK** to confirm

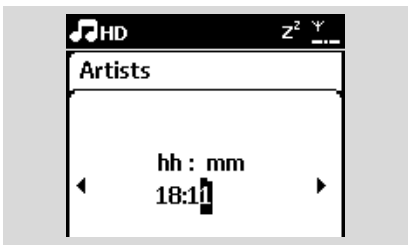

### 11.1.2 Setting repeat mode

- 1 To set repeat mode for the alarm sound.
  - a. In the alarm setting menu, press ▲ or ▼ and ► to select Repeat.



- b. Press ▲ or ▼ and ► to select the desired repeat mode.

→ **Once**: activates the alarm only once.

→ **Daily**: repeats the alarm every day.

## 11.2 Activating/de-activating alarm

### 11.2.1 Stopping alarm tone

- 1 When the alarm tone is heard, press any button  
→ The alarm tone will be stopped  
→ Your alarm settings remain unchanged

### 11.2.2 Activating/de-activating alarm

- 1 Enter the alarm setting menu.
  - a. Press **MENU**
  - b. Use the navigation controls ▲ or ▼ and ► to select Settings followed by Alarm
- 2 To toggle the alarm on/off
  - a. Press ▲ or ▼ and ► to select Alarm On/Off
  - b. Press ▲ or ▼ and ► to select On or Off.

# 12. Network setting

## 12.1 Adding Additional Station to the Wi-Fi network on the Center

Up to 5 Stations can be connected to the WAC7000 Center. When adding a Station to the Center's Wi-Fi network, you can play the Center's music library on the Station or move music playback between the Center and Stations (see HD). To add a Station to the Center's Wi-Fi network, proceed as follows:

### On the Center

- 1 Check that WAC7000 Center is in HD source
- 2 Select Add New Station
  - a. Press **MENU** to enter the menu screen
  - b. Press the navigation controls **▲** or **▼** and **▶** to enter Station Mgmt menu
  - c. Press **▲** or **▼** and **▶** to select Add New Station
    - You will enter Installation Mode. Searching for the new station starts
    - Playback stops on the previously associated Station if you are playing the HD source



### Helpful hints:

– If there are 5 stations connected, **Add New Station** option will not present. In this case, please delete a station first, and then to add new stations

### On Stations

- 3 Enter Installation Mode
  - a. Remove the power plug of the Stations, and then connect them to the power supply again
    - Connecting to Center appears
  - b. On the remote control, press **MENU** to enter Installation Mode
    - HD screen appears if the Station is connected to the Center
    - The Center and the Stations are now in the same Wi-Fi network

### On the Center

- 4 Press **STOP** ■ when all the Stations are found.

## 12.1.1 Deleting a Station

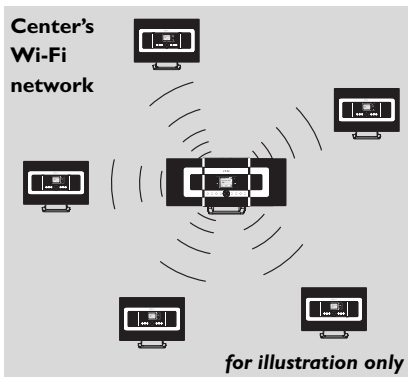

- 1 Check that the WAC7000 Center is in HD source
- 2 Select Delete Station.
  - a. Press **MENU** to enter the menu screen.
  - b. Press the navigation controls **▲** or **▼** and **▶** to enter Station Mgmt menu.
  - c. Press **▲** or **▼** and **▶** to select Delete Station
    - The list of connected Stations will be displayed on the Center
- 3 Press **▲** or **▼** and **▶** to select the Station you wish to delete.
- 4 Press **▲** or **▼** and **▶** to select Yes.

## 12.2 Connecting to external Wi-Fi network

The external Wi-Fi network can be a single PC or a PC network

For music playback within the external network, see UPnP: UPnP playback.

### 12.2.1 Network setting on Station

- 1 Check that the PC is switched on and the firewall is switched off
- 2 On the Station, search for networks
  - a. Press **MENU** to enter the menu screen
  - b. Press the navigation controls **▲** or **▼** and **▶** to enter Settings, followed by Network and Wireless
  - c. Press **▶** to continue
    - The display shows: Searching for Networks
    - The list of networks appears
    - The display shows: Network Not Found if no network is found
- 3
  - a. Select the network where your desired UPnP device is located.
  - b. Press **▶** to continue
- 4 If you have already set a WEP/WPA key for the UPnP device network:
  - a. Enter the WEP or WPA key by using the alphanumeric keys (see Preparation: Using Alphanumeric Keys)
  - b. Press **OK** to confirm

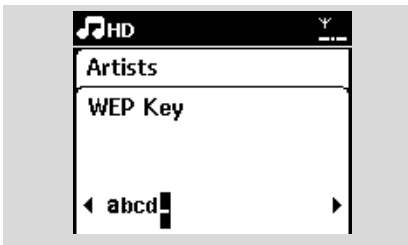

**If there is no WEP/WPA key for the UPnP device network:**

Press **OK** to skip

#### **Helpful hint:**

– For WEP/WPA key setting, always refer to the Access Point's user manual.

- 5 Select Automatic.

#### **Helpful hint:**

You can also select Static and assign an IP address as prompted using the alphanumeric keys.

- 6 As prompted, select Yes to apply the settings
  - The Station is connected to the external Wi-Fi network
  - The Station will be disconnected from the Center's Wi-Fi network

#### **External Wi-Fi network**

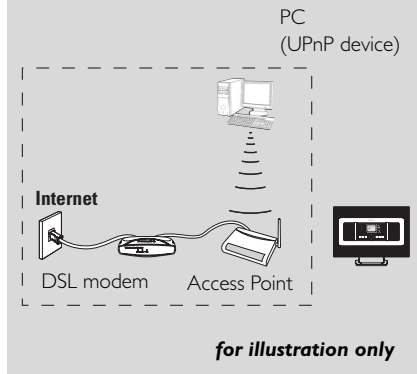

# 12. Network setting

## 12.3 Connecting to external wired network

The external wired network can be a single PC, a PC network, or a Station

The Station can access the wired and wireless network at the same time. Using the supplied Ethernet cable, you can connect the a Station separately to a wired network while maintaining its Wi-Fi connection (e.g. the Wi-Fi connection between the Center and Stations or the Wi-Fi connection with an external network).



### 12.3.1 Network setting on Station

- 1 Check that the device is switched on and the firewall (if available) is switched off
- 2 Connect the supplied Ethernet cable to the Ethernet ports on the device and the Station
- 3 On the Station, search for networks
  - a. Press **MENU** to enter the menu screen
  - b. Press the navigation controls ▲ or ▼ and ► and 2 to enter Settings, followed by Network and Wired
  - c. Press ► to continue.
- 4 If you are using a DHCP\*-enabled Access Point select Automatic  
\*DHCP stands for Dynamic Host Configuration Protocol. It is a protocol for assigning dynamic IP addresses to devices on a network.

#### If there is no DHCP

Select Static and assign an IP address and subnet mask as prompted using the alphanumeric keys (see Preparation: Using Alphanumeric Keys).



- 5 As prompted, select Yes to apply the settings  
→ On the display, the icon  is changed to 

### External wired network

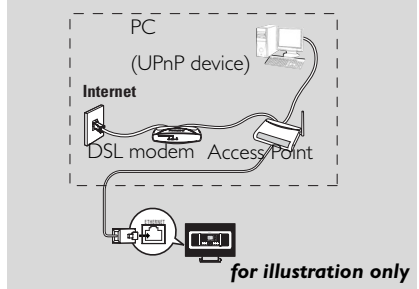

#### Helpful hint:

You can connect the Center or Station directly to your PC using the supplied Ethernet cable and the Wireless Audio Device Manager (WADM) in the bypacked PC Suite CD. For details, see the manual Connect to your PC.

### External wired network

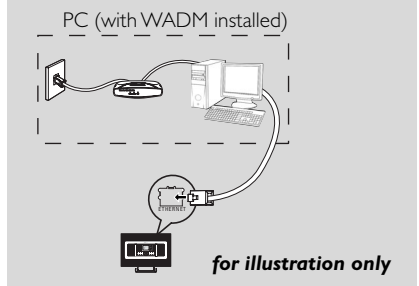

## 12.4 Viewing connection status

### 12.4.1 Viewing the connection with external network

- 1 Check that the Station is in HD source
- 2 Select Information on the Station
  - a. Press **MENU** to enter the menu screen
  - b. Press the navigation controls ▲ or ▼ and ► to enter Information menu.  
→ The display shows: System, WiFi and Ethernet
- 3 Press the navigation controls ▲ or ▼ and ► to select WiFi or Ethernet  
→ The display shows:  
In Wi-Fi: information about the Wi-Fi settings on the set.  
In Ethernet: information about the Ethernet settings on the set.

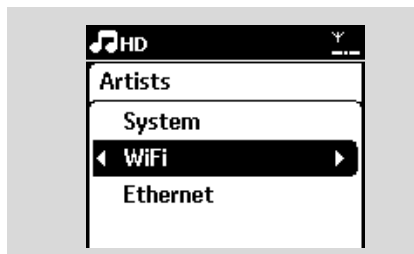

# 13. Reset

## 13.1 Reset

If desired, you can restore the Station to their default settings (including the network settings).

### When to reset the Station:

- Resetting the Station helps to re-establish the Wi-Fi connection between the Center and Station.
- Change the way the Station connects to an external Wi-Fi/wired network.

- 1 Check that the set is switched on (see Basic functions).
- 2 Press **MENU** to enter the menu screen
- 3 Press the navigation controls ▲ or ▼ and ► to enter Settings followed by Restore settings.

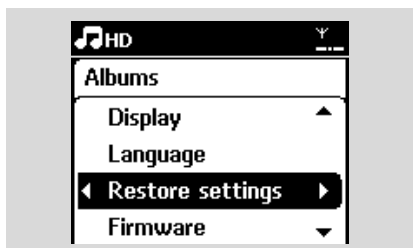

- 4 Press ► to select Yes  
→ The set is rebooted. Language selection screen appears.
- 5 Select your desired language: English, Français, Español, Nederlands, Italiano or Deutsch  
→ The set enters Installation Mode  
→ The search for Station starts. The Wi-Fi connection is being re-established



# 14. Firmware Upgrade

## 14.1 Firmware upgrade

You can upgrade your WAS7000 Station with the supplied PC Installer CD Wireless Audio Device Manager (WADM).

- 1 Register your WAS7000 on [www.club.philips.com](http://www.club.philips.com)
- 2 Download the firmware upgrade file and store it on your PC
- 3 Connect your WAS7000 to power supply
- 4 Connect your WAS7000 to PC via the supplied ethernet cable
- 5 Install and launch WADM. The PC shows as below:



- 6 Click **Device Configuration**. The PC shows as below:

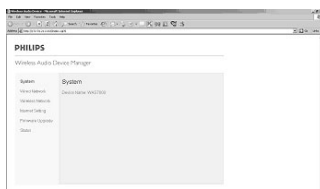

- 7 Click to enter the Firmware Upgrade sub-menu



- 8 Click **Firmware upgrade**. The PC shows as below:



- 9 Wait until "wait for firmware" shows on the WAS7000 display
- 10 Click **Refresh**  icon. The PC shows as below:

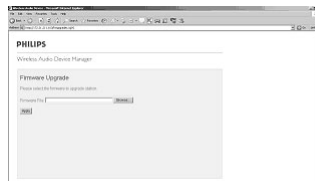

- 11 Click **Browse** and find the location where you kept the firmware upgrade file on your PC
- 12 Click **Apply** to start upgrading firmware



### On Philips Wireless Music Station:

- The display shows "**Updating firmware, please wait...**"
- WAS7000 will reboot itself during the installation process
- When the installation is completed, the PC shows as below, and the WAS7000 will return to UPnP mode.

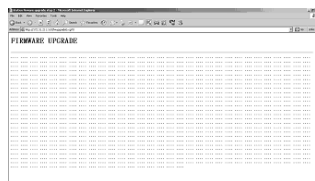

### IMPORTANT!

- **Never interrupt the firmware upgrading before its completion**
- **Before finishing the installation, never operate other functions**

# 15. Troubleshooting

## WARNING

Never try to repair the system yourself as this will invalidate the warranty. Do not open the system as there is a risk of electric shock.

If a fault occurs, first check the points listed below before taking the system for repair. If you are unable to resolve a problem by following these hints, consult your dealer or Philips for help.

### Problem

### Solution

**During the first-time setup, the display on the Station shows “Searching for Center”.**

### **I get interference on my wireless (Wi-Fi) link between the Center and Station.**

The WACS7000 operates in the 2.4GHz radio frequency spectrum. Many other household/IT devices also operate in this frequency spectrum, for example: microwave ovens, Dect phones, bluetooth devices like bluetooth headphones, computer mouse, wireless routers, cordless phones, Wi-Fi compatible printers, PDAs. These devices can interfere with the Wi-Fi link between the Center and Station, resulting in interference such as pause during playback, slow response to your operation, etc. The severity of interference varies depending on the extent of radiation from the device and the strength of Wi-Fi signals in that position.

- ✓ Check that you have placed the Center and Station side by side on a flat and firm surface.
- ✓ Check that you have connected the Center to the power supply.
- ✓ When adding a new station, check that the center is in Installation mode (see Network setting: Adding Additional Station to the Wi-Fi network on the Center).
- ✓ Turn off the wireless Access Point nearby if you encounter difficulty connecting the Center and Station.

If you are playing the set, stop playback and take the appropriate measures as follows:

- ✓ Keep the Center or Station at least 3 meters away from such devices.
- ✓ Use the WEP/WPA key when connecting the Center and Station to an existing wireless PC network. To set WEP/WPA key, connect Center/Station to your PC using Philips Wireless Audio Device Manager (WADM) in the by-packed PC Suite CD. In WADM's Device configuration, enter the Wireless Network sub-menu, and in Device Wireless Authentication Type, select WEP or WPA.
- ✓ Change the operating channel of the Center and Station when connecting them to an existing wireless PC network. To change channels, connect the Center/Station to your PC using Philips Wireless Audio Device Manager (WADM) in the by-packed PC Suite CD. In WADM's Device configuration, enter the SSID of your Wireless Network, and select Ad-hoc mode. See the manual Connect to your PC and the WADM help file.
- ✓ If possible, change the operating channels of the other Wi-Fi devices at your home.
- ✓ Turn the devices in different directions to minimize interference.

Problem	Solution
<p><b>Stations react when you operate the Center's remote control</b></p>	<ul style="list-style-type: none"> <li>✓ The remote control for the Center is powerful enough to operate several Stations within a certain distance or angle. Check that you have placed the Stations in different rooms or place them at different angles</li> <li>✓ Use the remote control for the Station or the controls on the set.</li> </ul>
<p><b>The remote control does not function properly</b></p>	<ul style="list-style-type: none"> <li>✓ Reduce the distance between the remote control and the set.</li> <li>✓ Insert the batteries with their polarities (+/- signs) aligned as indicated.</li> <li>✓ Replace the batteries.</li> <li>✓ Point the remote control directly towards the IR sensor.</li> </ul>
<p><b>Sound cannot be heard or is of poor quality.</b></p>	<ul style="list-style-type: none"> <li>✓ Adjust the volume.</li> <li>✓ Disconnect the headphones.</li> <li>✓ Switch off MUTE.</li> </ul>
<p><b>Some files on the USB device are not displayed</b></p>	<ul style="list-style-type: none"> <li>✓ Check if the number of folders exceeds 99 or the number of titles exceeds 999.</li> <li>✓ Only completely recorded MP3/WMA files can be found and played by WAS7000. Check if the file has been completely recorded.</li> <li>✓ DRM-protected WMA files cannot be played on WAS7000.</li> </ul>
<p><b>Radio reception is poor</b></p>	<ul style="list-style-type: none"> <li>✓ If the signal is too weak, adjust the antenna or connect an external antenna for better reception.</li> <li>✓ Increase the distance between the set and your TV or VCR.</li> </ul>
<p><b>There is interference on the radio reception whenever the Station is near my PC</b></p>	<ul style="list-style-type: none"> <li>✓ Install the supplied FM wire antenna for better reception.</li> <li>✓ Keep the Station at least 1 meter away from your PC.</li> </ul>
<p><b>How do I mount the Station onto walls?</b></p>	<ul style="list-style-type: none"> <li>✓ Use the by-packed wall mounting kits. It is recommended that you get a qualified personnel to fix the mounting brackets safely onto your walls before you mount the or Station. For details, refer to Appendix: How to mount your Station onto Walls.</li> </ul>
<p><b>Upgrading Station wirelessly failed.</b></p>	<ul style="list-style-type: none"> <li>✓ Upgrade the Station via ethernet cable following steps below:             <ol style="list-style-type: none"> <li>1. Connect the Station to your PC via the supplied ethernet cable and power on the Station.</li> <li>2. Download the firmware upgrade file specified for station.</li> <li>3. Launch WADM and click Firmware upgrade.</li> <li>4. Follow the on-screen information to complete the rest steps.</li> </ol> </li> </ul>

# 16. Appendix

## 16.1 How to mount your Station onto wall

### IMPORTANT!

- The wall mounting instructions are for the use of the qualified wall mounting person only!
- Ask a qualified person to help you with the wall mounting, which includes drilling holes on the wall, fixing the mounting brackets to the wall, and mounting the sets onto the brackets.

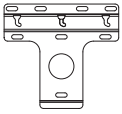

1 x mounting bracket



2 x screws (for Station mounting)

### 16.1.2 What else you'll need

- 6 x screws for fixing the Station's bracket
- Drilling tools (e.g. electric drill)

### 16.1.2 Preparation

- To find a suitable location for mounting, try your necessary rear connections and the Wi-Fi connection (see the chapter Installation).
- The qualified wall mounting personnel should:
  - learn about the piping, wiring and other relevant information inside your walls to avoid unexpected damages;
  - according to the materials of your walls, decide what type of screws you need to fix the mounting brackets that is able to withstand the weight of a Station;
  - according to the drilling requirements, choose suitable drilling tools;
  - take other precautions necessary for the wall mounting work

### 16.1.3 Mounting your Station

- 1 Align the bracket in the chosen location on a wall. Use a pencil to mark the drilling positions.

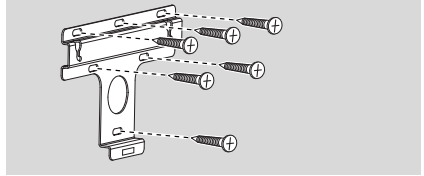

- 2 Drill holes as marked.
- 3 Fix the brackets to the wall using suitable screws (not supplied).
- 4 As shown, fasten the supplied screws to your Station using a screwdriver.

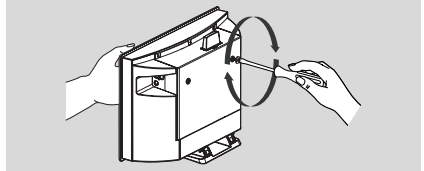

- 5 To detach the stand from Station,
  - a. As shown, hold down the **Lock•unlock** button(s).
  - b. Move out the stand to detach.

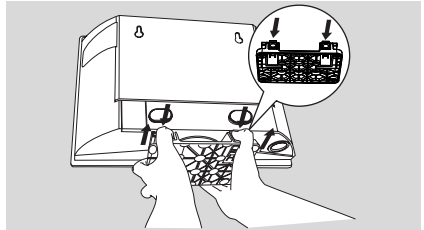

- 6 Hook and mount Station in place as shown

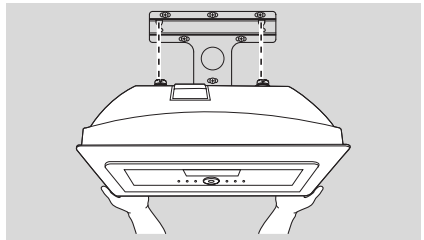

Meet Philips at the Internet  
<http://www.philips.com>



Be responsible  
Respect copyrights

Need help?

**Online**

Go to [www.philips.com/support](http://www.philips.com/support)

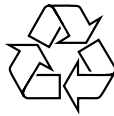

WAS7000



3141 075 21721



© Royal Philips Electronics N.V. 2006  
All rights reserved.

Printed in China

PDCC-Jason-0650