

User Manual	6
Manual del usuario	42
Manual do Usuário	78

Thank you for choosing Philips.

Need help fast?

Read your Quick Start Guide and/or User Manual first for quick tips that make using your Philips product more enjoyable.

***Register your product and get support
at www.philips.com/welcome***



PHILIPS

México



Es necesario que lea cuidadosamente su instructivo de manejo.

	PRECAUCION - ADVERTENCIA	
	NO ABRIR, RIESGO DE CHOQUE ELECTRICO	
ATENCION		
VERIFIQUE QUE EL VOLTAJE DE ALIMENTACION SEA EL REQUERIDO PARA SU APARATO		
PARA EVITAR EL RIESGO DE CHOQUE ELECTRICO, NO quite LA TAPA; EN CASO DE REQUERIR SERVICIO, DIRIJASE AL PERSONAL AUTORIZADO DE PHILIPS.		

Descripción: **Reproductor de DVD**
Modelo: **DVPI120**
Alimentación: **110 V – 240 V ~**
50/60 Hz
Consumo: **< 10 W**
Importador: **Philips Mexicana, S.A. de C.V.**
Domicilio: **Av. La Palma No. 6,**
Col. San Fernando, La Herradura
Huixquilucan, Edo de Mexico
C.P. 52784, Mexico
Localidad y Tel.: **Tel. 52 69 90 00**
Exportador: **Philips Electronics HK, Ltd.**
País de Origen: **China**
Nº de Serie: _____

**LEA CUIDADOSAMENTE ESTE INSTRUCTIVO
ANTES DE USAR SU APARATO.**

AVISO IMPORTANTE

Philips Mexicana, S.A. de C.V. no se hace responsable por daños o desperfectos causados por:

- *Maltrato, descuido o mal uso, presencia de insectos o roedores (cucarachas, ratones etc.).*
- *Cuando el aparato no haya sido operado de acuerdo con el instructivo del uso, fuera de los valores nominales y tolerancias de las tensiones (voltaje), frecuencia (ciclaje) de alimentación eléctrica y las características que deben reunir las instalaciones auxiliares.*
- *Por fenómenos naturales tales como: temblores, inundaciones, incendios, descargas electricas, rayos etc. o delitos causados por terceros (choques asaltos, riñas, etc.).*

LASER	
Type	Semiconductor laser InGaAlP (DVD) AlGaAs (CD)
Wave length	658 nm (DVD) 790 nm (CD)
Output Power	7.0 mW (DVD) 10.0 mW (VCD/CD)
Beam divergence	60 degrees

Due to the inconsistency of disc formats provided by various disc manufacturers, your DVD system/ player/recorder may require a playability enhancement or upgrade. As DVD technology advances, these enhancement will become common and will be easy to complete. Go to www.philips.com/support for software upgrade.

'CONSUMERS SHOULD NOTE THAT NOT ALL HIGH DEFINITION TELEVISION SETS ARE FULLY COMPATIBLE WITH THIS PRODUCT AND MAY CAUSE ARTIFACTS TO BE DISPLAYED IN THE PICTURE. IN CASE OF 525 OR 625 PROGRESSIVE SCAN PICTURE PROBLEMS, IT IS RECOMMENDED THAT THE USER SWITCH THE CONNECTION TO THE 'STANDARD DEFINITION' OUTPUT. IF THERE ARE QUESTIONS REGARDING OUR TV SET COMPATIBILITY WITH THIS MODEL 525p AND 625p DVD PLAYER, PLEASE CONTACT OUR CUSTOMER SERVICE CENTER.'

CAUTION

Use of controls or adjustments or performance of procedures other than herein may result in hazardous radiation exposure or other unsafe operation.

ATTENTION!

For Customer Use:

Read carefully the information located at the bottom or rear of your DVD Video player and enter below the Serial No. Retain this information for future reference.

Model No. DVPI 120

Serial No. _____



Manufactured under license from Dolby Laboratories, Dolby and the double-D symbol are trademarks of Dolby Laboratories.



Windows Media and the Windows logo are trademarks, or registered trademarks of Microsoft Corporation in the United States and/or other countries.

Language Code

Abkhazian	6566	Inupiaq	7375	Pushto	8083
Afar	6565	Irish	7165	Russian	8285
Afrikaans	6570	Íslenska	7383	Quechua	8185
Amharic	6577	Italiano	7384	Raeto-Romance	8277
Arabic	6582	Ivrit	7269	Romanian	8279
Armenian	7289	Japanese	7465	Rundi	8278
Assamese	6583	Javanese	7486	Samoan	8377
Avestan	6569	Kalaallisut	7576	Sango	8371
Aymara	6589	Kannada	7578	Sanskrit	8365
Azerhijani	6590	Kashmiri	7583	Sardinian	8367
Bahasa Melayu	7783	Kazakh	7575	Serbian	8382
Bashkir	6665	Kernewek	7587	Shona	8378
Belarusian	6669	Khmer	7577	Shqip	8381
Bengali	6678	Kinyarwanda	8287	Sindhi	8368
Bihari	6672	Kirghiz	7589	Sinhalese	8373
Bislama	6673	Komi	7586	Slovensky	8373
Bokmål, Norwegian	7866	Korean	7579	Slovenian	8376
Bosanski	6683	Kuanyama; Kwanyama	7574	Somali	8379
Brezhoneg	6682	Kurdish	7585	Sotho; Southern	8384
Bulgarian	6671	Lao	7679	South Ndebele	7882
Burmese	7789	Latina	7665	Sundanese	8385
Castellano, Español	6983	Latvian	7686	Suomi	7073
Catalán	6765	Letzeburgesch;	7666	Swahili	8387
Chamorro	6772	Limburgan; Limburger	7673	Swati	8383
Chechen	6769	Lingala	7678	Svenska	8386
Chewa; Chichewa; Nyanja	7889	Lithuanian	7684	Tagalog	8476
中文	9072	Luxembourgish;	7666	Tahitian	8489
Chuang; Zhuang	9065	Macedonian	7775	Tajik	8471
Church Slavic; Slavonic	6785	Malagasy	7771	Tamil	8465
Chuvash	6786	Magyar	7285	Tatar	8484
Corsican	6779	Malayalam	7776	Telugu	8469
Česky	6783	Maltese	7784	Thai	8472
Dansk	6865	Manx	7186	Tibetan	6679
Deutsch	6869	Maori	7773	Tigrinya	8473
Dzongkha	6890	Marathi	7782	Tonga (Tonga Islands)	8479
English	6978	Marshallese	7772	Tsonga	8483
Esperanto	6979	Moldavian	7779	Tswana	8478
Estonian	6984	Mongolian	7778	Türkçe	8482
Euskara	6985	Nauru	7865	Turkmen	8475
Ελληνικά	6976	Navaho; Navajo	7886	Twi	8487
Faroese	7079	Ndebele, North	7868	Uighur	8571
Français	7082	Ndebele, South	7882	Ukrainian	8575
Frysk	7089	Ndonga	7871	Urdu	8582
Fijian	7074	Nederlands	7876	Uzbek	8590
Gaelic; Scottish Gaelic	7168	Nepali	7869	Vietnamese	8673
Gallegh	7176	Norsk	7879	Volapuk	8679
Georgian	7565	Northern Sami	8369	Walloon	8765
Gikuyu; Kikuyu	7573	North Ndebele	7868	Welsh	6789
Guarani	7178	Norwegian Nynorsk;	7878	Wolof	8779
Gujarati	7185	Occitan; Provençal	7967	Xhosa	8872
Hausa	7265	Old Bulgarian; Old Slavonic	6785	Yiddish	8973
Herero	7290	Oriya	7982	Yoruba	8979
Hindi	7273	Oromo	7977	Zulu	9085
Hiri Motu	7279	Ossetian; Ossetic	7983		
Hrwatski	6779	Pali	8073		
Ido	7379	Panjabi	8065		
Interlingua (International)	7365	Persian	7065		
Interlingue	7365	Polski	8076		
Inuktitut	7385	Português	8084		

Index

English ----- 6

Español ----- 42

B. Português ----- 78

English

Español

B. Português

“Evite o uso prolongado do aparelho com volume superior a 85 decibéis pois isto poderá prejudicar a sua audição.”

Nível de Decibéis	Exemplos
30	Biblioteca silenciosa, sussurros leves
40	Sala de estar, refrigerador, quarto longe do trânsito
50	Trânsito leve, conversação normal, escritório silencioso
60	Ar condicionado a uma distância de 6 m, máquina de costura
70	Aspirador de pó, secador de cabelo, restaurante ruidoso
80	Tráfego médio de cidade, coletor de lixo, alarme de despertador a uma distância de 60 cm
OS RUÍDOS ABAIXO PODEM SER PERIGOSOS EM CASO DE EXPOSIÇÃO CONSTANTE	
90	Metrô, motocicleta, tráfego de caminhão, cortador de grama
100	Caminhão de lixo, serra elétrica, furadeira pneumática
120	Show de banda de rock em frente às caixas acústicas, trovão
140	Tiro de arma de fogo, avião a jato
180	Lançamento de foguete

This product incorporates copyright protection technology that is protected by method claims of certain U.S. patents and other intellectual property rights owned by Macrovision Corporation and other rights owners. Use of this copyright protection technology must be authorized by Macrovision Corporation, and is intended for home and other limited viewing uses only unless otherwise authorized by Macrovision Corporation. Reserve engineering or disassembly is prohibited.

Table of contents

General

General Information	8
Setup precautions.....	8
Accessories supplied	8
Cleaning discs	8
About recycling.....	8

Product Overview

Your DVD Player.....	9
Remote Control.....	10-12
Using the remote control	12

Connections

Basic Connections	13-14
Step 1: Connecting to television.....	13
Option 1: Using Composite Video jacks (CVBS).....	13
Option 2: Using Component Video jacks (Y Pb Pr).....	13
Step 2: Connecting the power cord.....	14
Optional Connections	15
Connecting to an Analog Stereo System.....	15
Connecting to a Digital AV Amplifier/Receiver.....	15

Basic Setup

Getting Started.....	16-18
Finding the correct viewing channel	16
Setting language preferences.....	16-17
On-screen display (OSD) language.....	16
Subtitle, Audio and Menu language for DVD playback.....	17
Setting up Progressive Scan feature	18

Disc Playback

Disc Operations	19-27
Playable discs	19
Region codes for DVD discs	19
Playing a disc	20
Basic playback controls.....	20
Selecting various repeat functions.....	21-22
Repeating a specific segment (A-B).....	22
Other playback features for video discs	22-23
Using the Disc Menu	22
Changing sound track language.....	23
Changing subtitle language	23
Zooming.....	23
Playback Control (VCD/SVCD).....	23

Table of contents

Using Display menu options	24-25
Selecting title/chaper/track	24
Searching by time	24
Switching camera angles.....	25
Playing a JPEG photo disc (slide show)	26
Zoom picture	26
Rotating the picture	26
Playing a MP3/ WMA disc	27

Setup Options

Setup Menu Options.....	28-34
Accessing the setup menu.....	28
Language Menu	29
Video Menu.....	30-31
Audio Menu	32
Rating Menu	33
Misc Menu	34

Others

Other Features.....	35
Installing the latest software	35
Troubleshooting.....	36-38
Specifications	39
Glossary.....	40-41

General Information

WARNING!

This unit does not contain any user-serviceable parts. Please leave all maintenance work to qualified personnel.

Setup precautions

Finding a suitable location

- Place this unit on a flat, hard and stable surface. Never place the unit on a carpet.
- Never place this unit on top of other equipment that might heat it up (e.g., receiver or amplifier).
- Never put anything under this unit (e.g., CDs, magazines).
- Install this unit near the AC outlet where the AC power plug can be easily reached.

Space for ventilation

- Place this unit in a location with adequate ventilation to prevent internal heat build up. Allow at least 10 cm (4") clearance from the rear and the top of this unit and 5 cm (2") from the left and right to prevent overheating.

Avoid high temperature, moisture, water and dust

- This unit must not be exposed to dripping or splashing.
- Never place any object or items that can damage this unit (e.g., liquid filled objects, lighted candles).

Accessories supplied

- 1 remote control with batteries
- 1 audio/video cables (yellow/white/red)
- 1 power cable

Cleaning discs

CAUTION!

Risk of damage to discs! Never use solvents such as benzene, thinner, cleaners available commercially, or anti-static sprays intended for discs.

- Wipe the disc with a micro fibre cleaning cloth from the centre to the edge in a straight line movement.

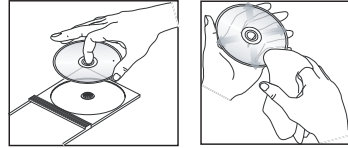

About recycling

This user manual is printed on non-polluting paper. This unit contains a large number of materials that can be recycled. If you are disposing an old equipment, please take it to a recycling center. Please observe the local regulations regarding disposal of packaging materials, exhausted batteries and old equipment.

Your DVD Player

English

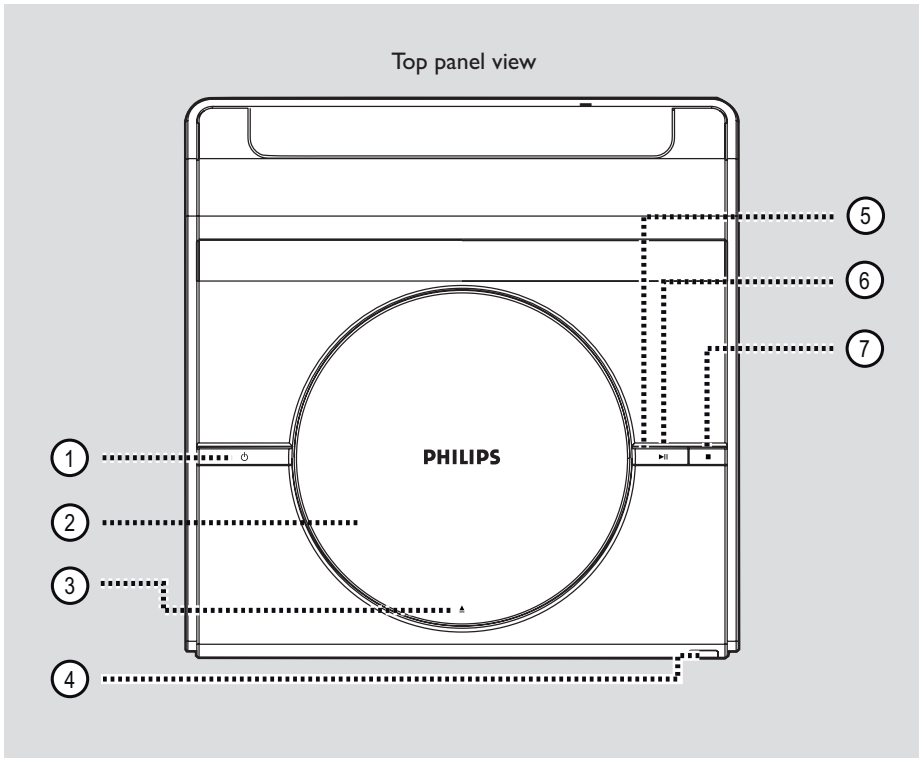

① **⏻ (STANDBY-ON)**

- Turns on this unit or turns off to normal standby mode.

② **Disc compartment**

③ **▲ (OPEN/CLOSE)**

- Opens/closes the disc compartment.

④ **IR Sensor**

- Point the remote control towards this sensor.

⑤ **LED light**

- Lights up when disc is playing.

⑥ **▶|| (PLAY/PAUSE)**

- Starts/pauses playback.

⑦ **■ (STOP)**

- Exits an operation.
- Disc: stops playback.

Remote Control

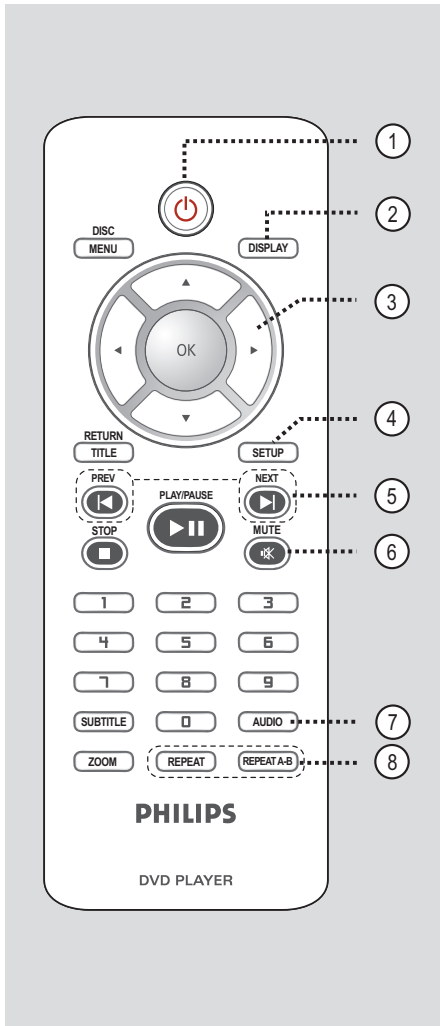

- ①
 - Turns on this unit or turns off to normal standby mode.
 - ② **DISPLAY**
 - Displays the current status or disc information.
 - ③
 - : press up or down for a slow forward or backward search.
 - : press left or right for fast forward or backward search.
 - ④ **SETUP**
 - Enters or exits the disc setup menu.
 - ⑤ **PREV / NEXT**
 - Skips to the previous or next title/ chapter/track.
 - Press and hold this button for fast forward or backward search.
 - ⑥ **MUTE**
 - Mutes or restores the volume.
 - ⑦ **AUDIO**
 - Selects an audio language or channel.
 - ⑧ **REPEAT**
 - Selects various repeat modes; turns off repeat mode.
- REPEAT A-B**
- Repeat playback a specific section on a disc.

Remote Control (continued)

English

- ⑨ **DISC MENU**
 - Enters or exits disc contents menu.
 - For VCD 2.0 and SVCD, switches on or off the playback control mode.

- ⑩ **OK**
 - Confirms an entry or selection.

- ⑪ **RETURN/TITLE**
 - Returns to the previous menu or shows title menu

- ⑫ **STOP ■**
 - Exits an operation.
 - Stops playback.

- ⑬ **PLAY/PAUSE ►||**
 - Starts or pauses playback.

- ⑭ **Numeric keypad 0-9**
 - Selects a track or chapter number of the disc.

- ⑮ **SUBTITLE**
 - Selects a DVD subtitle language.

- ⑯ **ZOOM**
 - Zoom the picture on the TV.

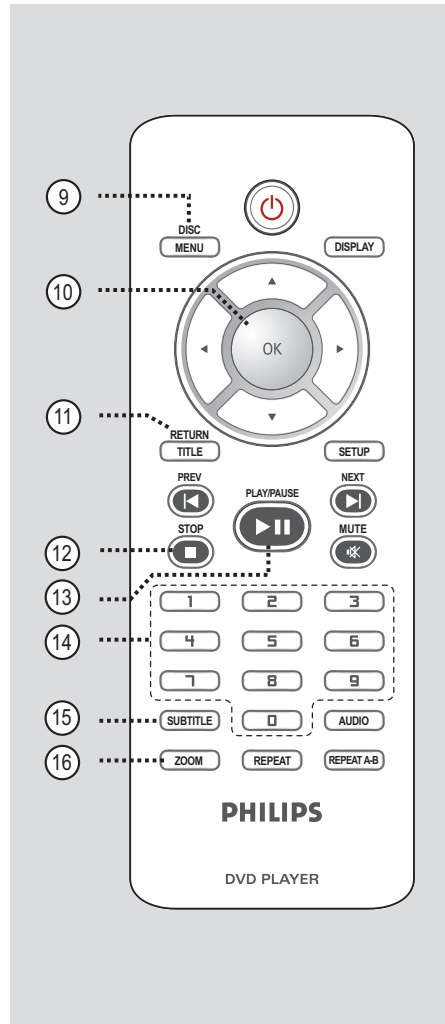

Remote Control (continued)

Using the remote control

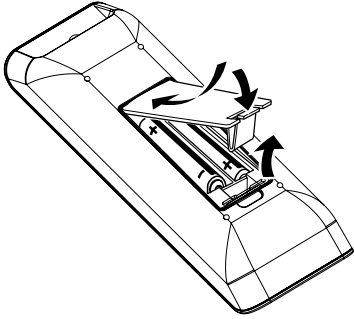

- 1 Open the battery compartment.
- 2 Insert two batteries type R03 or AAA, following the indications (+ -) inside the compartment.
- 3 Close the cover.
- 4 Point the remote control directly at the remote sensor (IR) on the front panel.

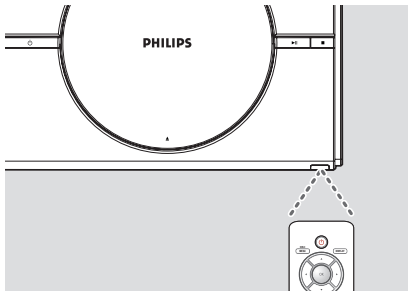

Note:

Never place any objects between the remote control and this unit while operating.

- 5 Select the desired function (for example ►II).

CAUTION!

- Remove batteries if they are exhausted or if the remote control is not to be used for a long time.
- Never mix batteries (old and new or carbon and alkaline, etc.).
- Batteries contain chemical substances; they should be disposed of properly.

Basic Connections

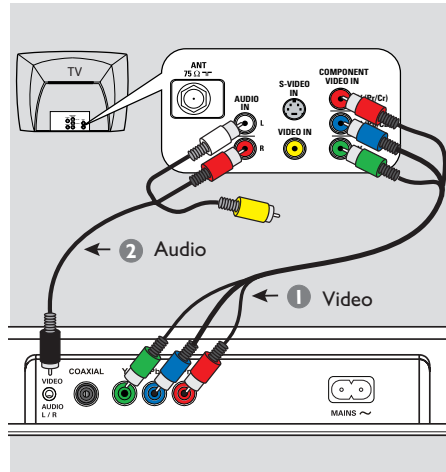
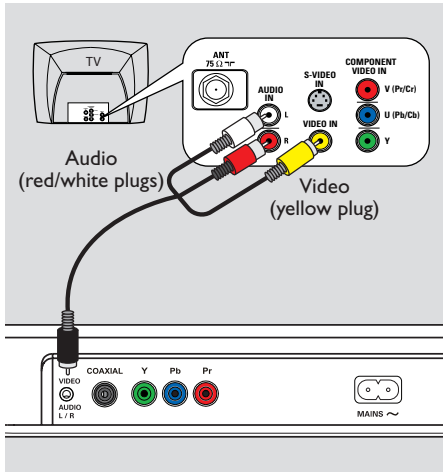

Step 1: Connecting to television

This connection enables you to view the video playback from this unit.

You only need to choose **one** of the options below to make the video connection.

- For a standard TV, follow option 1.
- For a progressive scan TV, follow option 2.

Option 1: Using Composite Video jacks (CVBS)

You can connect this unit to a TV through the composite video cable which provides good picture quality.

- Connect the audio/video cables (supplied) from the **VIDEO AUDIO L/R** jack on this unit to the video input jack (yellow) and Audio In jacks (red/white) on your TV.

Option 2: Using Component Video jacks (Y Pb Pr)

You can connect this unit to a TV through the component video cables which provides superior picture quality. The progressive scan video quality is only available when using Y Pb Pr connection and a progressive scan TV is required.

- 1 Connect the component video cables (red/blue/green - not supplied) from the **Y Pb Pr** jacks on this unit to the corresponding component video input jacks (or labeled as Y Pb/Cb Pr/Cr or YUV) on your TV.
- 2 Connect the audio/video cables (supplied) from the **VIDEO AUDIO L/R** jack on this unit to the Audio In jacks (red/white) on your TV. Leave the yellow video plug disconnected.
- 3 Proceed to 'Getting Started - Setting up Progressive Scan feature' for detailed progressive feature setup.

Basic Connections (continued)

English

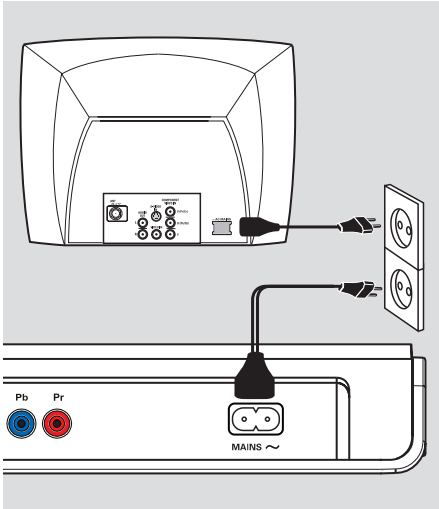

Step 2: Connecting the power cord

After everything is connected properly, plug the AC power cord into the power outlet.

Never make or change any connections with the power turned on.

Helpful Hint:

– Refer to the type plate at the rear or bottom of the product for identification and supply ratings.

Optional Connections

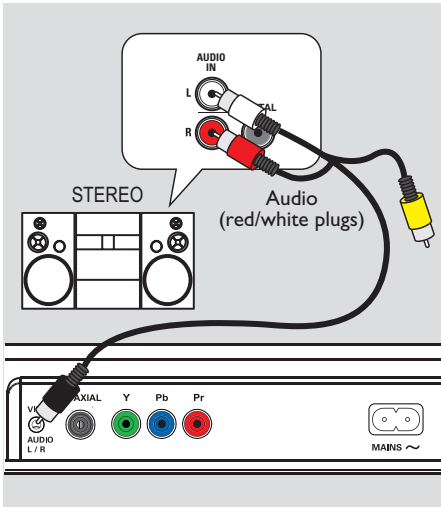

Connecting to an Analog Stereo System

You can connect this unit to a two channel stereo system (e.g. mini system, analog receiver) in order to enjoy stereo sound output.

- 1 Connect the audio/video cables (supplied) from the **VIDEO AUDIO L/R** jack on this unit to the Audio In jacks (red/white) on your connecting device. Leave the yellow video plug disconnected.
- 2 For video connection, see 'Basic Connections - Step 1: Connecting to television' for details.

Helpful Hint:

– See 'Setup Menu Options - Audio Menu' for optimum audio settings.

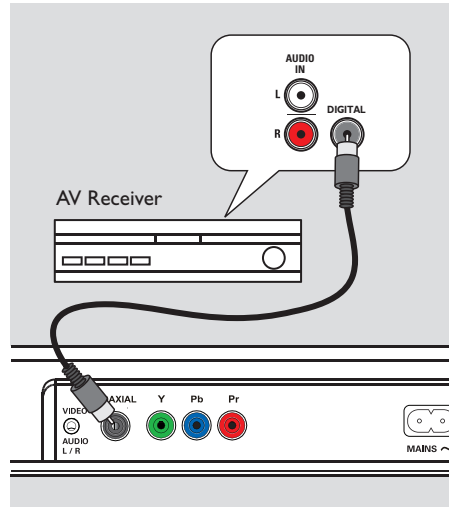

Connecting to a Digital AV Amplifier/Receiver

You can connect this unit to an AV amplifier/receiver in order to enjoy quality sound.



- 1 Connect a coaxial cable (not supplied) from the **COAXIAL** jack on this unit to the digital coaxial input jack of the connected device.
- 2 For video connection, see 'Basic Connections - Step 1: Connecting to television' for details.

Helpful Hint:

– You have to set the appropriate Digital Audio Output setting. Otherwise, no sound or interference may occur. See 'Setup Menu Options - Audio Menu - Digital Output' for details.

Getting Started

Finding the correct viewing channel





- 1 Press  to turn on this unit.
- 2 Turn on the TV and switch it to the correct video-in channel. You should see the blue DVD background screen.
 - You may go to the lowest channel on your TV, then press the Channel Down button on your TV remote control until you see the Video In channel.
 - You may press  button repeatedly on your TV remote control.
 - Usually this channel is between the lowest and highest channels and may be called FRONT, A/V IN, VIDEO, etc..
 - Refer to your TV user manual on how to select the correct input on your TV.
- 3 If you are using external device, (such as audio system or receiver), turn it on and select the appropriate input source for this unit output. Refer to the device user's manual for detail.

Setting language preferences

The language options are different depending on your country or region. It may not correspond to the illustrations shown on the user manual.

On-screen display (OSD) language

Select this to change the language of the On screen display menu of this unit. The menu language will remain once you have set it.

- 1 Press **SETUP** on the remote control.
- 2 Move to { **Language** } in the menu and press .
- 3 Use   keys to select { **OSD Language** } in the menu and press .



- 4 Select a language and press **OK** to confirm.

Getting Started (continued)

Subtitle, Audio and Menu language for DVD playback

You can select your preferred language settings for DVD playback. If the selected language is not available on the disc, the disc's default language is used instead.

- 1 Press **SETUP** on the remote control.
- 2 Move to { **Language** } in the menu and press **▶**.



- 3 Use **▲▼** keys to select one of the options below and press **▶**.

{ **Subtitle** }

Select this to change the subtitle language.

{ **Audio** }

Select this to change disc sound track language.

{ **DVD menu** }

Select this to change the language of the disc menu.

Getting Started (continued)

Setting up Progressive Scan feature

(for Progressive Scan TV only)

The progressive scan displays twice the number of frames per second than interlaced scanning (ordinary normal TV system). With nearly double the number of lines, progressive scan offers higher picture resolution and quality.

Before you start...

– Ensure that you have connected this unit to a progressive scan TV using the Y Pb Pr connection (see 'Option 2: Using Component Video jacks (Y Pb Pr)').

- ① Turn on the TV to the correct viewing channel for this unit.
→ Make sure that the TV progressive scan mode is turned off (or set to interlaced mode). Refer to your TV user manual.
- ② Turn on this unit and press **SETUP** on the remote control.
- ③ Use **▲▼** keys to select { **Video** } menu and press **▶**.
- ④ Move to { **Video Out** } in the menu and press **▶**.



- ⑤ Select { **P-Scan** } and press **OK** to confirm.
→ Read the notification message on the TV.

- ⑥ Use **◀▶** to select { **Yes** } in the menu and press **OK** to confirm.

There will be no picture on your TV at this state until you have turned on the progressive scan mode on your TV.

- ⑦ Turn on your TV progressive scan mode. (refer to your TV user manual.)
→ A message appears on the TV.
- ⑧ Use **◀▶** to select { **Yes** } in the menu and press **OK** to confirm.
→ The setup is now completed and you can start to enjoy the high quality picture.

If no picture is displayed

- ① Press **▲** on this unit.
- ② Press **numeric keypad '1'** on the remote control.

Helpful Hints:

- If a blank/distorted screen appears, wait for 15 seconds for the auto recovery.
- There are some progressive scan TV that are not fully compatible with this unit, resulting in an unnatural picture when playing back a DVD VIDEO disc in the progressive scan mode. In such a case, turn off the progressive scan feature on this unit and your TV.

Disc Operations

Playable discs















This unit plays:

- Digital Versatile Discs (DVDs)
- Video CDs (VCDs)
- Super Video CDs (SVCDs)
- Finalized DVD Recordable (DVD±R), DVD Rewritable (DVD±RW)
- Audio Compact Discs (CDs)
- MP3/ WMA discs
 - The file extension has to be '.mp3', '.wma'
 - JPEG/ISO format
 - Maximum 15 characters display.
 - Supported bit-rate;

<u>MP3</u>	
32 kHz	64 – 320 kbps
44.1 kHz, 48 kHz	80 – 320 kbps
<u>WMA</u>	
44 kHz	64 – 192 kbps
48 kHz	128 – 192 kbps
- Picture files (Kodak, JPEG) on CD-R(W)
 - The file extension has to be '.JPG' and not '.JPEG.'
 - JPEG/ISO format
 - It can only display DCF-standard still pictures or JPEG pictures such as TIFF.

Region codes for DVD discs

DVD discs and players are designed with regional restrictions. Before playing a disc, make sure the disc is for the same region as your player.

Region	Discs that can be played
U.S.A. and Canada regions	 
U.K and Europe regions	 
Asia Pacific, Taiwan, Korea	 
Australia, New Zealand, Latin America	 
Russia and India regions	 
China, Calcos Islands, Walls and Futuna Islands	 

Helpful Hints:





- Maximum 100 sessions for CD and 10 multi border for DVD are supported.
- For DVD-R and DVD-RW multi border, only finalized disc are supported.
- For DVD+R and DVD+RW multi border both finalized and unfinalized disc are not supported.

Disc Operations (continued)

Notes:

- If the inhibit icon  appears on the TV when a button is pressed, it means the function is not available on the current disc or at the current time.
- Never put any objects other than discs in the disc compartment. Doing so may cause the disc player to malfunction.

Playing a disc



- 1 Press  to turn on this unit.
- 2 Turn on the TV to the correct viewing channel for this unit.
- 3 Press  to open the disc compartment.
- 4 Insert a disc into the disc compartment and press .
 - Make sure the disc label is facing towards you.
- 5 Playback starts automatically.
 - If not, press .
 - See the following pages for more playback options and features.

Helpful Hints:



- If you are having trouble playing a certain disc, remove the disc and try a different one. Improperly formatted discs cannot be played on this unit.
- Some discs cannot be played on this player due to the configuration and characteristics of the disc, or due to the condition of recording and authoring software that was used.

Basic playback controls





Pausing playback

- During playback, press **PLAY/PAUSE** .
 - To resume playback, press **PLAY/PAUSE** .





Selecting another track/chapter/ title

- Press **PREV**  / **NEXT**  or use the numeric keypad 0-9 to enter a track/ chapter/title number.
 - If the repeat track mode is active, press **PREV**  again to replay the same track/chapter/title.

Searching backward/forward

- Press and hold **PREV**  / **NEXT** .
 - While searching, press  /  repeatedly to select different search speed (2X, 4X, 8X, 16X, 32X).
 - To resume normal playback, press **PLAY/PAUSE** .

Playing in slow motion mode (not applicable for CD)

- During playback, press  /  to start slow motion play.
 - Sound will be muted. Press  /  repeatedly to select different play speed (1/2, 1/4, 1/8, 1/16).
 - To resume normal playback, press **PLAY/PAUSE** .

Stopping playback

- Press **STOP** .

Disc Operations (continued)

Helpful Hints:

- This unit has resume playback ability (for certain type of disc). In this case, if you want to playback from the beginning, press **PREV**  while the message 'Play from start, press [PREV]' appears on the TV.
- This is a power-saving feature, this unit automatically switches to low power standby mode if you do not press any buttons within 15 minutes after a disc has stopped playing.
- Screen saver starts automatically if the disc playback is stopped for about 5 minutes.

Selecting various repeat functions

The repeat play options mode varies depending on the disc type.

- While playing a disc, press **REPEAT** on the remote control repeatedly to choose a repeat play mode.

DVD

- Chapter (repeat current chapter)
- Title (repeat current title)
- Off (exit repeat mode)

VCD/SVCD/CD

- Single (repeat current track)
- All (repeat entire disc)
- Off (exit repeat mode)

MP3/JPEG/WMA

- Single (repeat current file)
- All (repeat all files in the current folder)
- Off (exit repeat mode)

- To cancel repeat play mode, press **REPEAT** repeatedly until 'Off' appears or press **STOP**  twice.

Helpful Hint:

- Repeat playback is not possible on VCDs or SVCDs when the PBC mode is turned on.

Disc Operations (continued)

Repeating a specific segment (A-B)

You can repeat the playback of a specific segment within a title/chapter/track. To do this, you must mark the start and end of the segment you want.

- 1 During playback, press **REPEAT A-B** at the point where you want the repeat playback to begin.
- 2 Press **REPEAT A-B** again at the point where you want to end the repeat playback.
→ Playback skips to the start of the marked segment. The segment is repeated until the repeat mode is cancelled.
- 3 To cancel repeat playback, press **REPEAT A-B** again.

Other playback features for video discs

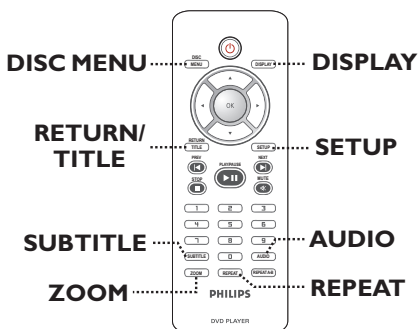

Note:

The operating features described here might not be possible for certain discs. Always refer to the instructions supplied with the discs.

Using the Disc Menu

Depending on the disc, a menu may appear on the TV once you load in the disc.

To select a playback feature or item

- Use **▲▼◀▶** keys or **numeric keypad 0-9** on the remote control, then press **OK** to start playback.

To access or remove the menu

- Press **DISC MENU** on the remote control.

Disc Operations (continued)

Changing sound track language

This operation works only on DVDs with multiple sound track languages, or SVCDs with multiple audio channels.

For DVD

- Press **AUDIO** repeatedly to select the available audio languages.

For VCD (changing the audio channel)

- Press **AUDIO** repeatedly to select the available audio channels provided by the disc (LEFT, RIGHT, MIX, STEREO).

Changing subtitle language

This operation works only on DVDs with multiple subtitle languages. You can change to your desired language during playback.

- Press **SUBTITLE** repeatedly to select different subtitle languages.

Zooming

This option allows you to zoom and to pan through the picture on the TV.

- 1 During playback, press **ZOOM** repeatedly to select a different zoom factor.
→ Playback continues.
- 2 Use **▲▼◀▶** keys to pan through the enlarged picture.
- 3 Press **ZOOM** repeatedly to return to the original size.

Playback Control (VCD/SVCD)

Playback Control (PBC) playback allows you to play Video CDs interactively, following the menu on the display.

For VCDs with PBC feature (version 2.0 only) and SVCDs

- Press **DISC MENU** to turn on or off the PBC mode.
 - If the PBC mode is turned on, the disc menu (if available) appears on the TV.
 - If the PBC mode is turned off, it skips the disc menu and playback from the first track.
- If the PBC mode is turned on, pressing **RETURN/TITLE** during playback will return to the disc title menu or main menu.

Disc Operations (continued)

Using Display menu options

This unit can display the disc playback information (for example, title or chapter number, elapsed playing time), a number of operations can be done without interrupting disc playback.

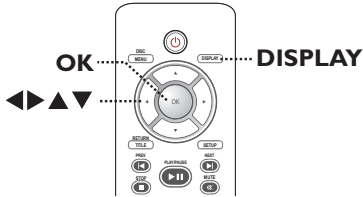

- 1 During playback, press **DISPLAY** repeatedly on the remote control.
→ The available disc information appears on the TV.

(DVD)

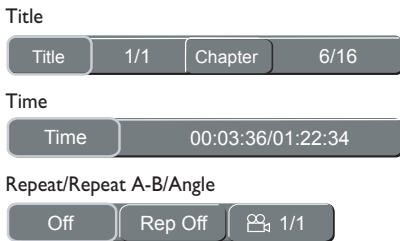

(VCD)

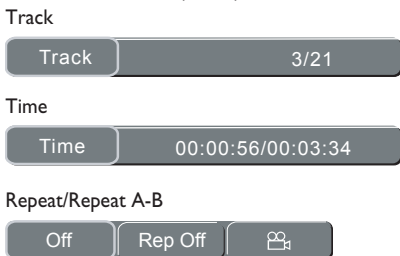

- 2 Use the **numeric keypad 0-9** to input the number/time or use ◀▶ keys to make the selection.
- 3 Press **OK** to confirm.
→ Playback changes to the chosen operation.

Selecting title/chapter/track

This option allows you to skip to a specific title/chapter/track in the current disc.

- 1 Move to { **Title** } / { **Chapter** } or { **Track** } option in the display menu.

Note: { **Track** } option can only be selected if PBC is set to off. See 'Disc Operations - Playback Control (VCD/SVCD)' for details.

- 2 Use the **numeric keypad 0-9** to input the a valid number.
- 3 Press **OK** to confirm.
→ Playback skips to the chosen title/ chapter/track.

Searching by time

This option allows you to skip to a specific point in the current disc.

- 1 Move to { **Time** } option.
- 2 Use the **numeric keypad 0-9** to enter the time where playback should start (eg. 0:34:27).
- 3 Press **OK** to confirm.
→ Playback skips to the selected time.

Disc Operations (continued)

Switching camera angles

This option is only available on DVDs that contain sequences recorded from different camera angles. This allows you to view the picture from different angles.

- 1 Move to { **Repeat/ Repeat A-B/ Angle** } option in the display menu.
- 2 Use ◀▶ keys to select the angle symbol .
- 3 Press **OK** repeatedly to switch between different angle.
→ Playback changes to the selected angle.

Disc Operations (continued)

Playing a JPEG photo disc (slide show)

Before you start ...

Turn on your TV to the correct Video In channel. See 'Finding the correct viewing channel' for details.

- Load a JPEG photo CD (Kodak Picture CD, JPEG).
→ The picture menu appears on the TV. Press **PLAY/PAUSE** **▶II** to start the slide-show playback.

Helpful Hints:

– It may require longer time for this unit to display the disc content on the TV due to the large number of songs/pictures compiled into one disc.

Supported file format:

- The file extension has to be '*.JPG' and not '*.JPEG'.
- This unit can only display digital camera pictures according to the JPEG-EXIF format, typically used by almost all digital cameras. It cannot display Motion JPEG, progressive JPEG and other JPEG formats, or sound clips associated with pictures.

Zoom picture

During playback,

- 1 Press **ZOOM** repeatedly to select a magnification level.
- 2 Use **▲▼◀▶** keys to pan through the enlarged picture.

Rotating the picture

- During playback, use **▲▼◀▶** keys to rotate the picture on the TV.
 - **▲**: rotate the picture vertically -180° .
 - **▼**: rotate the picture vertically $+180^\circ$.
 - **◀**: rotate the picture counter-clockwise.
 - **▶**: rotate the picture clockwise.

Disc Operations (continued)

Playing a MP3/WMA disc

This unit can playback most of the MP3 and WMA files recorded on a recordable disc or commercial CD.

Before you start ...

Turn on your TV to the correct Video In channel. See 'Finding the correct viewing channel' for details.

- 1 Load a MP3/WMA disc.
 - The disc reading time may exceed 30 seconds due to the complexity of the directory/file configuration.
 - The disc menu appears on the TV.



- 2 Use ▲▼ keys to select a desired folder and press **OK** to open the folder.
- 3 Use ▲▼ keys to select a track/file and press **OK** to start playback.
 - Playback starts from the selected file and continues through to the end of the folder.

During playback:

- Use **PREV** ◀ / **NEXT** ▶ to playback another track/file in the current folder.
- Press and hold **PREV** ◀ / **NEXT** ▶ to fast forward/backward search on the music track.
- To select another folder from current disc, use ▲▼◀▶ keys to navigate back to the root menu.
- 4 To stop playback, press **STOP** ■.

Helpful Hints:

- Only the first session of a multi-session CD will be played back.
- It is normal to experience an occasional 'skip' while listening to your MP3/WMA disc due to poor clarity of digital contents during internet downloading.
- If any special characters are present in the MP3/WMA track name (ID3) or album name, it might not be displayed correctly on the screen because this unit does not support the characters.

Setup Menu Options

Accessing the setup menu

This unit setup is carried out via the TV, enabling you to customize it to suit your particular requirements.

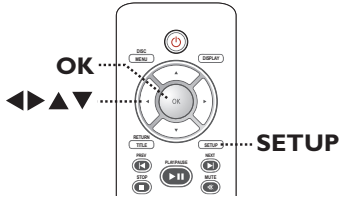

- 1 Press **SETUP** on the remote control.
→ The setup menu appears.
- 2 Use **▲▼** keys to select one of the setup menu options and press **▶** to access.



- 3 Use **▲▼** keys to select the option you wish to change and press **▶**.
- 4 Use **▲▼** keys to select the setting that you wish to change and press **OK** to confirm.
→ Instructions and explanations of the options are provided in the following pages.
→ If the option in the menu is grayed out, that means the setting is not available or cannot be changed in the current state.
- 5 To exit, press **SETUP**.



See 'Language Menu' on this chapter.

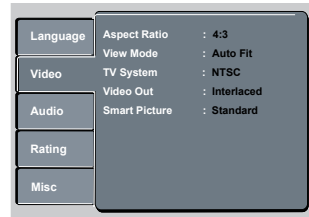

See 'Video Menu' on this chapter.

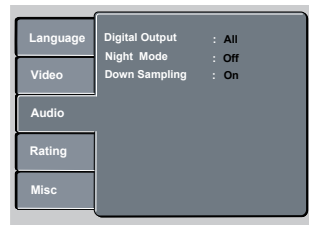

See 'Audio Menu' on this chapter.

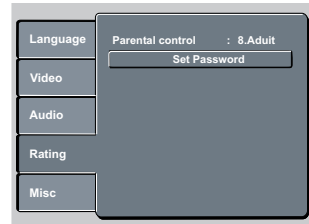

See 'Rating Menu' on this chapter.

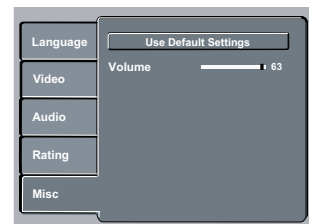

See 'Misc Menu' on this chapter.

Setup Menu Options (continued)

Language Menu (underlined options are the factory default settings)

OSD Language

Select the menu language for this unit's on-screen display.
See 'Getting Started – Setting language preferences'.

Subtitle

Select the preferred subtitle language for DVD playback.

Audio

Select the preferred audio language for DVD playback.

DVD Menu

Select the preferred disc menu language for DVD playback.

Note: If the selected audio/subtitle/disc menu language is not available on the DVD, the disc's default language will be used instead.

Setup Menu Options (continued)

Video Menu (underlined options are the factory default settings)

Aspect Ratio

The picture shape can be adjusted to fit your TV.

{ 4:3 } – For a 'wide-screen' display with black bars on the top and bottom.



{ 16:9 } – For wide-screen TV (frame ratio 16:9).



View Mode

This setting allows you to scale the picture to fit the TV width and height.

{ Fill } – Scale the picture to fill the screen height and width equally.

{ Original } – Scale the picture to fit to the original screen size (only for MPEG).

{ Height Fit } – Scale the picture to fit the screen height.

{ Width Fit } – Scale the picture to fit the screen width.

{ Auto Fit } – Scale the picture proportionally with minimum screen ratio.

{ Pan Scan } – Scale the picture proportionally with maximum screen ratio.

TV System

Select the color system that matches the connected TV. It enables playback of a different type of disc (PAL or NTSC disc) on this unit.

{ NTSC } – For NTSC-system TV.

{ PAL } – For PAL-system TV.

{ Multi } – For TV that is compatible with both PAL and NTSC.

Confirm the setting by pressing ◀ to select { **Yes** } in the menu and press **OK** on the remote control.

Setup Menu Options (continued)

Video Menu (underlined options are the factory default settings)

Video Out

Ensure that your TV can accept progressive signals (a progressive scan TV is required) and that you have connected this unit to your TV using the Y Pb Pr. See 'Getting Started - Setting up the progressive scan feature' for details.

- { Interlaced } – Turn off progressive scan mode.
- { P-Scan } – Turn on progressive scan mode.

Confirm the setting by pressing ◀ to select { **Yes** } in the menu and press **OK** on the remote control.

Smart Picture

This unit provides three predefined sets of picture color settings and one personal setting which you can define yourself.

- { Standard } – Original color setting.
- { Vivid } – Vibrant color setting.
- { Cool } – Soft color setting.
- { Personal } – Select this to personalize the picture color setting. Use the ◀▶ keys to adjust to the setting that best suits your personal preference. For an average setting, select { 0 }.



Setup Menu Options (continued)

Audio Menu (underlined options are the factory default settings)

Digital Output

This setting is only required if the COAXIAL/DIGITAL OUT socket of this unit is connected to other audio/video device.

- { Off } – Deactivate the digital audio output. For example, if you use the AUDIO OUT sockets to connect this unit to a TV or Stereo system.
- { PCM } – The connected device does not support multi-channel formats. This unit converts multi-channel to PCM (Pulse Code Modulation) format.
- { ALL } – The connected device supports multi-channel audio formats. The digital audio format will be output as on disc.

Note: If the { Digital Output } is set to { All } during MPEG, MP3 or WMA playback, the audio output will be in PCM format.

Night Mode

This mode optimizes playback of sound at low volume. High volume outputs will be softened and low volume outputs will be enhanced to an audible level. This feature is only applicable for DVD video discs with Dolby Digital mode.

- { Off } – Turn off night mode. Select this to enjoy the surround sound with its full dynamic range.
- { On } – Turn on night mode.

Down Sampling

This feature enables you to disable digital signal processing for better sound quality.

- { Off } – Play disc recorded at sampling rate of 96kHz. This rate can only be achieved in Stereo-Classic (Flat) mode.
- { On } – Play disc recorded at sampling rate of 48kHz.

Setup Menu Options (continued)

Rating Menu (underlined options are the factory default settings)

Parental Control

This is to prohibit viewing of discs that had exceeded the limits you set. It works only on the DVDs with parental level assigned to the complete disc or to certain scenes on the disc.

- 1) Use the **numeric keypad 0-9** on the remote control to enter your 4-digit password and press **OK**.
- 2) Use **▲▼** keys to select a rating level from 1 to 8 and press **OK**.

Notes:

- The ratings are country-dependent ('1' is considered material that is least offensive and '8' is most offensive). To disable parental controls and allow all discs to play, select '8'.
- Some DVDs are not encoded with a rating though the movie rating may be printed on the disc cover. The rating level feature does not prohibit playback of such discs. VCD, SVCD and CD have no level indication, so parental control has no effect on these type of discs.
- DVDs that are rated higher than the level you selected will not be played unless you enter the same 4-digit password.

Set Password

The password is used for Parental Control. The default password is '0000'.

To change the password:

- 1) Use **▲▼** keys to select { Set Password } and press **OK**.
- 2) Use the **numeric keypad 0-9** on the remote control to enter your existing 4-digit password at { Password }.



Note: When doing this for the first time or if you forget your existing password, enter '0000'.

- 3) Press **OK** to proceed.
- 4) Enter the new 4-digit password at { New Password }.
- 5) Press **OK** to confirm and press **SETUP** to exit the menu..

Setup Menu Options (continued)

Misc Menu (underlined options are the factory default settings)

Use Default Settings

This feature enables you to reset all the setup menu options and your personal settings to the factory defaults, except your password for Parental Control.

- { **Yes** } – Select this to reset to factory default settings.
- { **No** } – Select this to keep the existing setting.

Use ◀▶ keys to make a selection and press **OK** to confirm.

Volume

This feature allows you to adjust the volume level.

Use ◀▶ keys to set the volume level between 0 ~ 63.
(60 is the default setting)

Installing the latest software

Periodically Philips issue software upgrades to enhance the user experience.

- ① Get the software version of this unit by pressing **▲** to open the disc compartment
- ② Press **numeric keypad '966'** on the remote control.
→ Write down the file name of your current software.
- ③ Visit the Philips website 'www.philips.com/support' to check the availability of the latest software upgrade and download the software to a CD-R.

Note:

Never unplug or turn off this unit during upgrade.



- ④ Insert the CD-R to the disc compartment.
→ A message appears.
- ⑤ Press **OK** to confirm.
→ Installation of software starts.
→ Once complete, this unit will power off automatically.

Troubleshooting

WARNING

Under no circumstances should you try to repair this unit yourself, as this invalidate the warranty. Do not open this unit as there is a risk of electric shock.

If a fault occurs, first check the points listed below before taking this unit for repair. If you are unable to remedy a problem by following these hints, consult your dealer or Philips for help.

Problem	Solution
No power.	<ul style="list-style-type: none"> – Press  on the unit to turn on the power. – Ensure that the AC outlet have power. – Disconnect the power cord from the power outlet for a few minutes. Reconnect the power cord and try to operate again as usual.
No picture.	<ul style="list-style-type: none"> – Refer to your TV manual for correct Video In channel selection. Change the TV channel until you see the DVD screen. – If this happens when you turn on the progressive scan feature, wait for 15 seconds for the auto recovery or switch back to the default mode as below: <ol style="list-style-type: none"> 1) Press  on this unit. 2) Press and hold numeric keypad '1' on the remote control. – If this happens after you set the color system, wait for 15 seconds for the auto recovery or switch back to the default TV color system: <ol style="list-style-type: none"> 1) Press  on this unit. 2) Press and hold numeric keypad '3' on the remote control.
Completely distorted picture or black/white picture.	<ul style="list-style-type: none"> – Check the video connection. – Ensure that the disc is compatible with this unit. – Sometimes a small amount of picture distortion may appear. This is not a malfunction. – The disc is dirty. Clean the disc.

Troubleshooting (continued)

Problem	Solution
No sound or distorted sound.	<ul style="list-style-type: none">– Check the audio connections to the connected audio device.– Make sure that the connected audio device is turned on to the correct input source.– Set the digital output setting correctly, based on the device you connected to this unit. See “Audio Menu – Digital Output” for details.
The remote control does not function properly.	<ul style="list-style-type: none">– Aim the remote control directly at the sensor on the front of this unit (not towards the TV).– Remove any obstacles between this unit and the remote control.– Batteries are weak, replace the batteries.– Check the polarities of the batteries are as indicated on the remote control (\pm signs).
The unit does not start playback.	<ul style="list-style-type: none">– Insert a readable disc with the playback side facing inwards. The DVD+R/CD-R must be finalized.– Make sure the disc is not scratched or warped. Check if the disc is defective by trying another disc.– The disc is of a different region code.– You may need to enter the password in order to unlock the disc for playback.– Moisture may have condensed inside this unit. Remove the disc and leave this unit turned on for about an hour.
The buttons on the unit do not work.	<ul style="list-style-type: none">– There is a technical problem. Disconnect this unit from the power outlet for 10 seconds and reconnect again.

Troubleshooting (continued)

English

Problem	Solution
The aspect ratio of the screen cannot be changed even though you have set the TV display.	<ul style="list-style-type: none">- The aspect ratio is fixed on the DVD disc.- Depending on the TV, it may not be possible to change the aspect ratio.
Not able to select some items in the setup/system menu.	<ul style="list-style-type: none">- Press STOP button twice before selecting the disc setup menu.- Depending on the disc availability, some menu items cannot be selected.
Picture freezes momentarily during playback.	<ul style="list-style-type: none">- Check the disc for fingerprint/scratches and clean with a soft cloth wiping from center to edge.
Unable to select Progressive Scan on/off.	<ul style="list-style-type: none">- Check that the video output of this unit is connected using the Component Video (Y Pb Pr) jacks.

Specifications

TV STANDARD

	(PAL/50Hz)	(NTSC/60Hz)
Number of lines	625	525
Playback	Multistandard	(PAL/NTSC)

VIDEO PERFORMANCE

Video DAC	12 bit, 108 MHz
Y Pb Pr	0.7 Vpp ~ 75 ohm
Video Output	1 Vpp ~ 75 ohm

VIDEO FORMAT

Digital	MPEG 2 for DVD, SVCD
Compression	MPEG 1 for VCD

	50 Hz	60 Hz
Horiz. resolution	720 pixels	720 pixels
Vertical resolution	576 lines	480 lines

	50 Hz	60 Hz
Horiz. resolution	352 pixels	352 pixels
Vertical resolution	288 lines	240 lines

AUDIO FORMAT

Digital	MPEG/ AC-3/ PCM	compressed Digital 16, 20, 24 bits fs, 44.1, 48, 96 kHz
	MP3 (ISO 9660)	96, 112, 128, 256 kbps & variable bit rate fs, 32, 44.1, 48 kHz

Analog Sound Stereo
 Dolby Surround compatible downmix from Dolby
 Digital multi-channel sound

AUDIO PERFORMANCE

DA Converter	24 bit, 192 kHz
DVD	fs 96 kHz 4 Hz - 44 kHz fs 48 kHz 4 Hz - 22 kHz
SVCD	fs 48 kHz 4 Hz - 22 kHz fs 44.1 kHz 4 Hz - 20 kHz
CD/VCD	fs 44.1 kHz 4 Hz - 20 kHz
Signal-Noise (1kHz)	> 90 dB
Dynamic range(1kHz)	> 80 dB
Crosstalk (1kHz)	> 70 dB
Distortion/noise (1kHz)	> 65 dB
MPEG MP3	MPEG Audio L3

CONNECTIONS

Y Pb Pr Output	Cinch 3x
Video Output cum	
Audio Output*(L+R)	3.5mm jack (1x)
Digital Output	1 coaxial IEC60958 for CDDA / LPCM IEC61937 for MPEG 1/2, Dolby Digital

* Audio and Video output share one jack at the rear panel of this unit.

CABINET

Dimensions (w x h x d)	250 x 52 x 250 mm
Weight	Approximately 0.879 kg

POWER CONSUMPTION

Power Supply Rating	110 V – 240 V; 50/60 Hz
Power consumption	< 10 W
Power consumption in Standby mode	< 1 W

Specifications are subject to change without prior notice.

Glossary

Analog audio: Sound that has not been turned into numbers. Analog sound is available when you use the AUDIO LEFT/RIGHT jacks. These red and white jacks send audio through two channels, the left and right.

Aspect ratio: Aspect ratio refers to the length to height ratio of TV. The ratio of a standard TV is 4:3, while the ratio of a high-definition or wide TV is 16:9. The letter box allows you to enjoy a picture with a wider perspective on a standard 4:3 screen.

Bit Rate: The amount of data used to hold a given length of music; measured in kilobits per second, or kbps. Or, the speed at which you record. Generally, the higher the bit rate, or the higher the recording speed, the better the sound quality. However, higher bit rates use more space on a disc.

Chapter: Sections of a picture or a music piece on a DVD that are smaller than titles. A title is composed of several chapters. Each chapter is assigned a chapter number enabling you to locate the chapter you want.

CVBS: Composite video (or Composite Video Blanking and Sync). A single video signal commonly used in most consumer video products.

DVD menu: A screen display prepared for allowing a selection of images, sounds, subtitles, multi-angles, etc., recorded on a DVD.

Dolby Digital: A surround sound system developed by Dolby Laboratories containing up to six channels of digital audio (front left and right, surround left and right, center and subwoofer).

JPEG: A very common digital still picture format. A still-picture data compression system proposed by the Joint Photographic Expert Group, which features small decrease in image quality in spite of its high compression ratio. Files are recognized by their file extension 'JPG or JPEG'.

MP3: A file format with a sound data compression system. 'MP3' is the abbreviation of Motion Picture Experts Group 1 (or MPEG-1) Audio Layer3. By using the MP3 format, one CD-R or CD-RW can contain about 10 times more data than a regular CD.

Parental Control: A function of the DVD to limit playback of the disc by the age of the users according to the limitation level in each country. The limitation varies from disc to disc; when it is activated, playback will be prohibited if the software's level is higher than the user-set level.

PBC: Playback Control. A system of navigating a Video CD/Super VCD through on-screen menus recorded onto the disc. You can enjoy interactive playback and searching.

PCM (Pulse Code Modulation): A system for converting analog sound signal to digital signal for later processing, with no data compression used in conversion.

Progressive Scan: The progressive scan displays twice the number of frames per second than in an ordinary TV system. It offers higher picture resolution and quality.

Glossary (continued)

English

Region code: A system allowing discs to be played only in the region designated. This unit will only play discs that have compatible region codes. You can find the region code of your unit by looking at the product label. Some discs are compatible with more than one region (or ALL regions).

Title: The longest section of a movie or music feature on DVD. Each title is assigned a title number, enabling you to locate the title you want.

VIDEO AUDIO L/R jack: Jack on the back of this unit that sends out audio and video signals to the TV.

WMA: Windows Media™ Audio. Refers to an audio compression technology developed by Microsoft Corporation. WMA data can be encoded by using Windows Media Player version 9 or Windows Media Player for Windows XP. Files are recognized by their file extension 'WMA'.