

# Always there to help you

Register your product and get support at  
[www.philips.com/welcome](http://www.philips.com/welcome)



FWT6600



## User manual

# PHILIPS



# Contents

---

<b>1 Important</b>	<b>2</b>
Safety	2
Notice	3

---

<b>2 Your Mini Hi-Fi System</b>	<b>4</b>
Introduction	4
What's in the box	4
Overview of the main unit	5
Overview of the remote control	6

---

<b>3 Connect</b>	<b>8</b>
Connect FM antenna	8
Connect AM antenna	8
Connect speakers	9
Connect speakers' LEDs	9
Connect power	10

---

<b>4 Get started</b>	<b>11</b>
Prepare the remote control	11
Auto install radio stations	11
Set clock	11
Turn on	12

---

<b>5 Play from a disc or USB</b>	<b>13</b>
Play disc	13
Play from a USB device	13
Play options	14

---

<b>6 Play audio through Bluetooth</b>	<b>15</b>
---------------------------------------	-----------

---

<b>7 Listen to an external device</b>	<b>16</b>
Listen to an MP3 player	16
Listen to a PC	16

---

<b>8 Listen to radio</b>	<b>17</b>
Tune to a radio station	17
Program radio stations manually	17
Program radio stations automatically	17
Select a preset radio station	17
Change AM tuning grid	17

---

<b>9 Adjust volume level and sound effect</b>	<b>18</b>
Adjust volume level	18
Mute sound	18
Boost loudness	18
Select a preset sound effect	18
Enhance bass	18
Virtual surround	18

---

<b>10 USB record</b>	<b>19</b>
Record to a USB device	19
Schedule radio-to-USB record	19

---

<b>11 Other features</b>	<b>21</b>
Set the alarm timer	21
Set the sleep timer	21
Karaoke	21
Copy files from USB 1 to USB 2	22

---

<b>12 Product information</b>	<b>23</b>
Specifications	23
USB playability information	24
Supported MP3 disc formats	24
Maintenance	24

---

<b>13 Troubleshooting</b>	<b>25</b>
---------------------------	-----------

# 1 Important

## Safety



This 'bolt of lightning' indicates uninsulated material within your unit may cause an electrical shock. For the safety of everyone in your household, please do not remove product covering.

The 'exclamation point' calls attention to features for which you should read the enclosed literature closely to prevent operating and maintenance problems.

**WARNING:** To reduce the risk of fire or electric shock, this apparatus should not be exposed to rain or moisture and objects filled with liquids, such as vases, should not be placed on this apparatus.

**CAUTION:** To prevent electric shock, match wide blade of plug to wide slot, fully insert.

## Important Safety Instructions

- ① Read these instructions.
- ② Keep these instructions.
- ③ Heed all warnings.
- ④ Follow all instructions.
- ⑤ Do not use this apparatus near water.
- ⑥ Clean only with dry cloth.
- ⑦ Install in accordance with the manufacturer's instructions.
- ⑧ Do not install near any heat sources such as radiators, heat registers, stoves, or other apparatus (including amplifiers) that produce heat.
- ⑨ Protect the power cord from being walked on or pinched, particularly at plugs, convenience receptacles, and the point where they exit from the apparatus.
- ⑩ Only use attachments/accessories specified by the manufacturer.
- ⑪ Use only with the cart, stand, tripod, bracket, or table specified by the manufacturer or sold with the apparatus. When a cart is used, use caution when moving the cart/apparatus combination to avoid injury from tip-over.
- ⑫ Unplug this apparatus during lightning storms or when unused for long periods of time.
- ⑬ Refer all servicing to qualified service personnel. Servicing is required when the apparatus has been damaged in any way, such as power-supply cord or plug is damaged, liquid has been spilled or objects have fallen into the apparatus, the apparatus has been exposed to rain or moisture, does not operate normally, or has been dropped.
- ⑭ **Battery usage CAUTION** – To prevent battery leakage which may result in bodily injury, property damage, or damage to the unit:
  - Install all batteries correctly, + and - as marked on the unit.
  - Do not mix batteries (old and new or carbon and alkaline, etc.).
  - Remove batteries when the unit is not used for a long time.



- Batteries (battery pack or batteries installed) shall not be exposed to excessive heat such as sunshine, fire or the like.

- 15) Apparatus shall not be exposed to dripping or splashing.
- 16) Do not place any sources of danger on the apparatus (e.g. liquid filled objects, lighted candles).
- 17) Where the MAINS plug or an appliance coupler is used as the disconnect device, the disconnect device shall remain readily operable.

### Warning

- Never remove the casing of this apparatus.
- Never lubricate any part of this apparatus.
- Never place this apparatus on other electrical equipment.
- Keep this apparatus away from direct sunlight, naked flames or heat.
- Never look into the laser beam inside this apparatus.
- Ensure that you always have easy access to the power cord, plug or adaptor to disconnect this apparatus from the power.

### Caution

- Use of controls or adjustments or performance of procedures other than herein may result in hazardous radiation exposure or other unsafe operation.

programs, files, broadcasts and sound recordings, may be an infringement of copyrights and constitute a criminal offence. This equipment should not be used for such purposes.

### Environmental information

All unnecessary packaging has been omitted. We have tried to make the packaging easy to separate into three materials: cardboard (box), polystyrene foam (buffer) and polyethylene (bags, protective foam sheet.) Your system consists of materials which can be recycled and reused if disassembled by a specialized company. Please observe the local regulations regarding the disposal of packaging materials, exhausted batteries and old equipment.

This apparatus includes this label:



### Note

- The type plate is located on the back of the unit.

## Notice

Any changes or modifications made to this device that are not expressly approved by Philips Consumer Lifestyle may void the user's authority to operate the equipment.



The making of unauthorized copies of copy-protected material, including computer

## 2 Your Mini Hi-Fi System

Congratulations on your purchase, and welcome to Philips! To fully benefit from the support that Philips offers, register your product at [www.Philips.com/welcome](http://www.Philips.com/welcome).

### Introduction

With this unit, you can enjoy audio from discs, USB devices, Bluetooth devices or external devices. You can also listen to radio stations through it.

To enrich sound, this unit offers you these sound effects:

- MAX sound for instant power boost
- Digital Sound Control (DSC)
- Dynamic Bass Boost (DBB)
- Incredible surround (IS)
- Virtual Ambience-based Control (VAC)

The unit supports the following media formats:



---

### What's in the box

Check and identify the contents of your package:

- Main unit x 1
- Speaker x 2
- Subwoofer x 2
- Remote control with 2 AAA batteries
- FM wire antenna x 1
- AM loop antenna x 1
- 3.5mm audio link cable x 1
- Plug converter x 1
- Plastic spacer x 2
- Printing materials

## Overview of the main unit

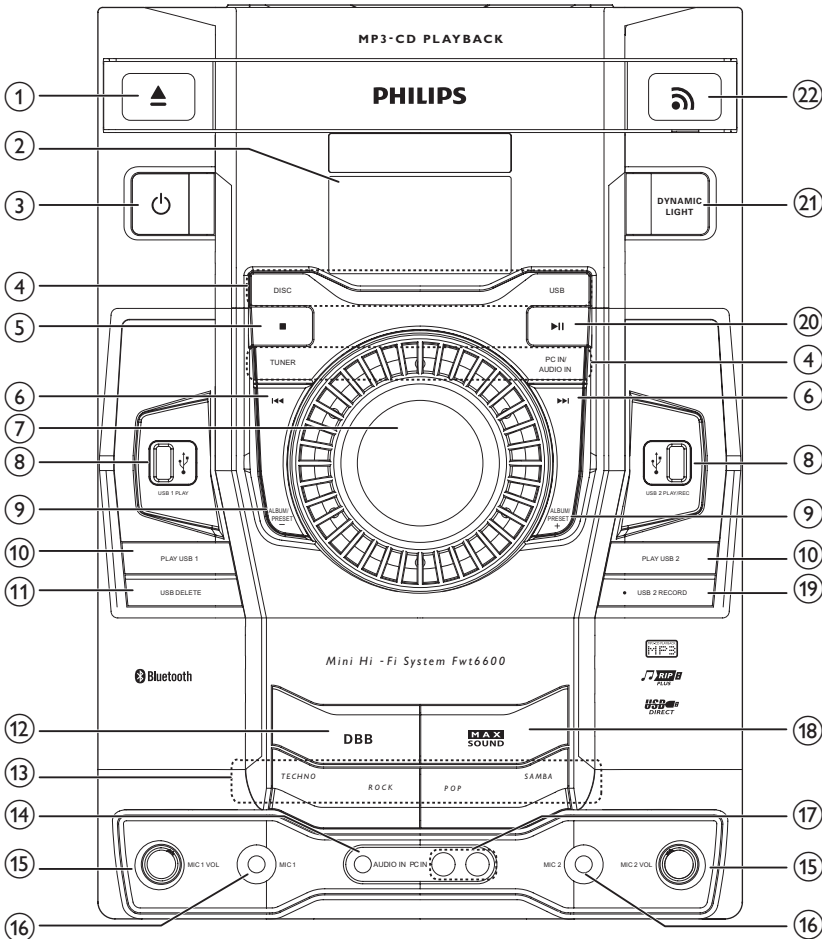

- ① ▲
  - Open or close the disc compartment.
- ② Display panel
  - Show status.
- ③ ⏻
  - Turn on the unit or switch to standby mode.

- ④ Source selection keys
  - Select a source.
- ⑤ ■
  - Stop play or erase a program.
- ⑥ ⏮ / ⏭
  - In Disc/USB/Bluetooth mode, skip to the previous/next track.
  - In Disc/USB mode, search within a track.
  - Tune to a radio station.

- 7 **Volume dial**
  - Rotate clockwise to increase volume; rotate counterclockwise to decrease volume.
- 8 **USB 1 PLAY/USB 2 PLAY/REC**
  - Jack for a USB mass storage device.
  - Record to USB.
- 9 **ALBUM/PRESET+/-**
  - Skip to the previous/next album.
  - Select a preset radio station.
- 10 **PLAY USB 1/PLAY USB 2**
  - Play audio from USB source.
- 11 **USB DELETE**
  - Delete audio files stored on a USB device.
- 12 **DBB**
  - Turn on or off dynamic bass enhancement.
- 13 **DSC sound effects keys**
  - Select a preset sound equalizer setting.
- 14 **MIC 1 VOL/MIC 2 VOL**
  - Adjust microphone volume.
- 15 **MIC 1/2 (Microphone port)**
  - Jack for a microphone.
- 16 **AUDIO IN**
  - Audio input jack (3.5mm) for an external audio device.
- 17 **PC IN**
  - Connect to an external device.
- 18 **MAX SOUND**
  - Turn on or off instant power boost for sound.
- 19 **USB 2 RECORD**
  - Record to a USB device.
- 20 **▶||**
  - Start or pause play.
- 21 **DYNAMIC LIGHT**
  - Turn on or off the lighting effect.
- 22 **Bluetooth indicator**

## Overview of the remote control

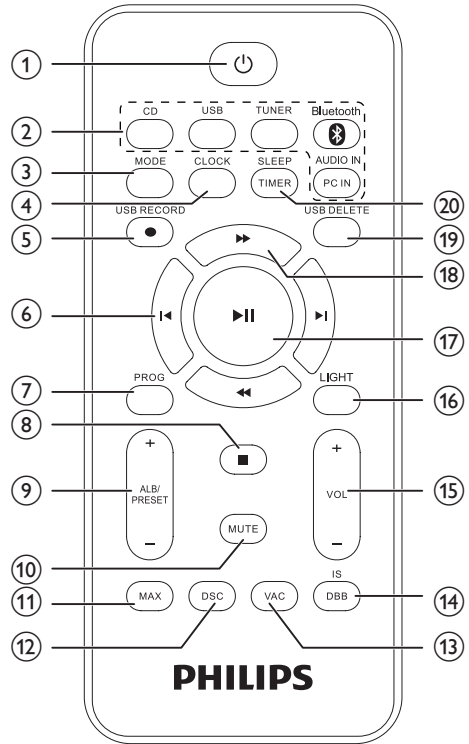

- 1 **⏻**
  - Turn on the unit or switch to standby mode.
- 2 **Source selection keys**
  - Select a source.
- 3 **MODE**
  - In Disc/USB mode, select repeat play or random play.
- 4 **CLOCK**
  - Set the clock.
  - View the clock during play.
- 5 **USB RECORD**
  - Record to a USB device.



⑥ **⏮ / ⏭**

- In Disc/USB/Bluetooth mode, skip to the previous/next track.
- When setting clock, select hour format and adjust hour and minute.
- When setting alarm, adjust alarm clock and sound source.

⑦ **PROG**

- Program tracks.
- Program radio stations.

⑧ **■**

- In Disc/USB mode, stop playing.
- In Disc/USB mode, erase programs.
- Exit the process of recording, setting clock and timer; or auto installing radio stations.

⑨ **ALB/PRESET+/-**

- Skip to the previous/next album.
- Select a preset radio station.

⑩ **MUTE**

- Mute volume.

⑪ **MAX**

- Turn on or off instant power boost for sound.

⑫ **DSC**

- Select a preset sound equalizer.

⑬ **VAC**

- Select an ambience -based equalizer setting.

⑭ **DBB/IS**

- Turn on or off dynamic bass enhancement.
- Turn on or off incredible surround.

⑮ **VOL +/-**

- Adjust volume.

⑯ **LIGHT**

- Turn on or off the lighting effect.

⑰ **▶ ||**

- Start or pause play.

⑱ **◀◀ / ▶▶**

- Adjust radio frequency.
- When playing from disc/USB, search within a track.

⑲ **USB DELETE**

- Delete audio files stored on a USB storage device.

⑳ **SLEEP/TIMER**

- Set the sleep timer.
- Set the alarm timer.
- Turn on or off sleep/alarm timer.

# 3 Connect

## Connect FM antenna

Connect the supplied FM antenna to the **FM** jack on the back of the main unit.

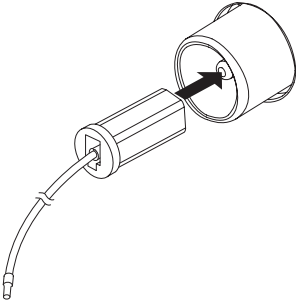

## Connect AM antenna

- 1 Assemble the AM loop antenna.

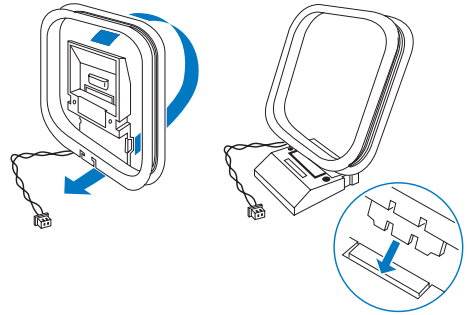

- 2 Connect the AM loop antenna to the **AM** jack on the back of the main unit. Adjust the position of the antenna for optimal reception.

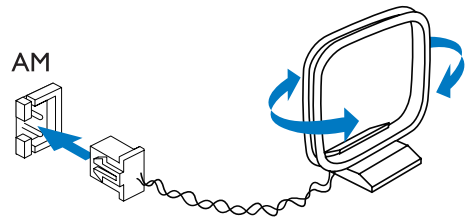

## Connect speakers

### Note

- For optimal sound, use the supplied speakers only.
- Connect only speakers with impedance that is the same or higher than the supplied speakers. Refer to the Specifications section of this manual.

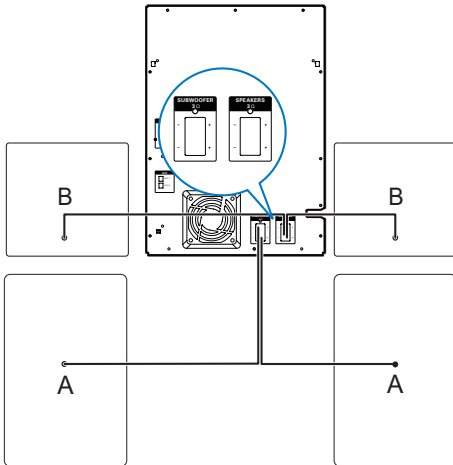

A: Subwoofers; B: Speakers

### Connect the speakers

- 1 Find "SPEAKERS" sockets in black on the main unit.
- 2 Insert the connector of the speaker wires to the connectors.

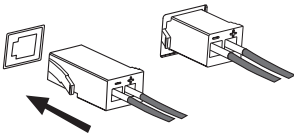

### Connect these subwoofers

- 3 Find "SUBWOOFER" sockets in blue on the main unit.
- 4 Insert the connectors of the subwoofer wires to the "SUBWOOFER" sockets.

## Place speakers

You can place the speakers on the top of the subwoofers.

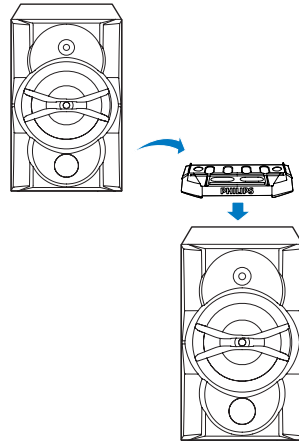

- 1 Place a plastic spacer on the top of one of the subwoofers.
- 2 Place a speaker on the plastic spacer steadily.
- 3 Follow the above steps to place the other speaker.

## Connect speakers' LEDs

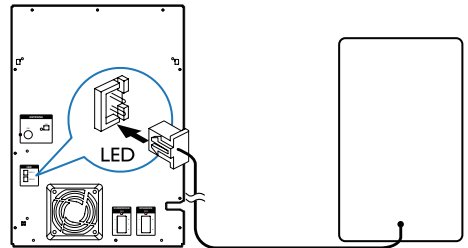

- 1 Find a LED socket on the back of the main unit.
- 2 Insert the connector of the LED wire to the LED socket.
- 3 Follow the steps above to connect the rest of speaker LEDs.

## Connect power

- 1 If your power supply voltage is 110V-127V, adjust the voltage selector (locate on the bottom panel of unit) to 110V-127V.

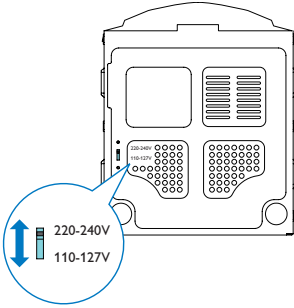

- 2 Connect the AC power plug to the power outlet.

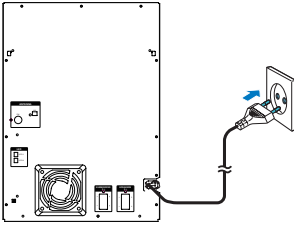

### ! Caution

- Risk of product damage! Make sure that the power supply voltage corresponds to the voltage set on the voltage selector on the bottom of the unit.
- Before connecting to the AC power, make sure that you have completed all other connections.

## 4 Get started

### ! Caution

- Use of controls or adjustments or performance of procedures other than herein may result in hazardous radiation exposure or other unsafe operation.

Always follow the instructions in this chapter in sequence.

If you contact Philips, you will be asked for the model and serial number of this apparatus. The model number and serial number are on the back of the apparatus. Write the numbers here:

Model No. \_\_\_\_\_

Serial No. \_\_\_\_\_

## Prepare the remote control

### ≡ Note

- Risk of explosion! Keep batteries away from heat, sunshine or fire. Never discard batteries in fire.
- Danger of explosion if battery is incorrectly replaced. Replace only with the same or equivalent type.

To replace the remote control battery:

- 1 Open the battery compartment.
- 2 Insert two AAA batteries with correct polarity (+/-) as indicated.
- 3 Close the battery compartment.

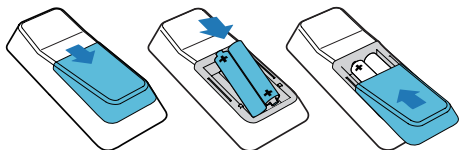

### ≡ Note

- If you are not going to use the remote control for a long time, remove the batteries.
- Do not use old and new or different types of batteries in combination.
- Batteries contain chemical substances, so they should be disposed of properly.

## Auto install radio stations

When you connect power and no radio stations are stored, the unit automatically begins to store radio stations.

- 1 Connect the unit to the power supply.  
↳ [AUTO INSTALL - PRESS PLAY] (auto install - press the PLAY button) is displayed.
- 2 Press **▶||** on the main unit to start installation.  
↳ [AUTO] (auto) is displayed.  
↳ The unit automatically stores radio stations with sufficient signal strength.  
↳ When all the available radio stations are stored, the first preset radio station is broadcast automatically.

## Set clock

- 1 In the standby mode, press **CLOCK** to activate the clock setting mode.  
↳ The 12 hour or 24 hour format is displayed.
- 2 Press **ALB/PRESET+/-** repeatedly to select 12 hour or 24 hour format.
- 3 Press **CLOCK** to confirm.  
↳ The clock digits are displayed and begin to blink.
- 4 Press **ALB/PRESET+/-** to set the hour.
- 5 Press **◀/▶** to set the minute.
- 6 Press **CLOCK** to confirm.

### \* Tip

- To view the clock during play, press **CLOCK**.

---

## Turn on

Press  $\phi$ .

- ↳ The unit switches to the last selected source.

---

## Switch to standby

Press  $\phi$  to switch the unit to standby mode.

- ↳ The backlight on the display panel turns off.
- ↳ The clock (if set) appears on the display panel.

# 5 Play from a disc or USB

## Play disc

- 1 Press **CD** to select the disc source.
- 2 Press **▲** on the main unit to open the disc compartment.
- 3 Load a disc on the disc tray, with the printed side facing up.
- 4 Press **▲** on the main unit to close the disc compartment.
  - ↳ Play starts automatically.
  - To pause/resume play, press **▶||**.
  - To stop play, press **■**.
  - To select another track, press **◀|▶**.
  - To select an album, press **ALB/PRESET+/-**.
  - To search within a track, press and hold **◀◀/▶▶**, then release to resume normal play.

## Play from a USB device

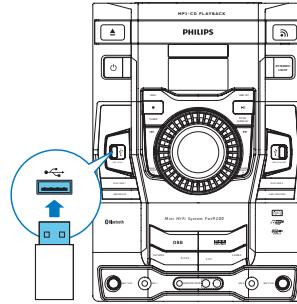

### Note

- Ensure that the USB device contains playable audio contents for supported formats.

- 1 Insert the USB plug of the device into the **USB 1 PLAY** or **USB 2 PLAY/REC** socket.
- 2 Press **USB** to select the USB source.
- 3 Press **ALB/PRESET+/-** to select a folder.
- 4 Press **◀|▶** to select an audio file.
  - ↳ Play starts automatically.
  - To pause/resume play, press **▶||**.
  - To stop play, press **■**.
  - To search within an audio file, press and hold **◀◀/▶▶**, then release to resume normal play.

## Delete from a USB device





- 1 During play from a USB device, press **◀|▶** to select an audio file.
  - To delete an audio folder; in the stop position, press **ALB/PRESET+/-** to select an audio folder.
- 2 Press **USB DELETE**.
  - ↳ A confirmation message is displayed.
- 3 While the message is displayed, press **USB DELETE** again to confirm.
  - To cancel, press **■**.

---

# Play options

---

## Repeat and random play

- 1 Press **MODE** repeatedly to select:
  - : the current track is played repeatedly.
  - : all tracks are played repeatedly.
  - : all tracks are played randomly and repeatedly.
  - : all tracks are played randomly.
- 2 To return to normal play, press **MODE** repeatedly until play mode is no longer displayed.







### Tip

- Shuffle play cannot be selected when you play programmed tracks.

---

## Program tracks

You can program a maximum of 40 tracks.

- 1 In Disc/USB mode, press  to pause playing.
- 2 Press **PROG** to activate program mode.
  - ↳ A position number and [PROG] (program) flash on the screen.
- 3 For MP3 tracks, press **ALB/PRESET+/-** to select an album.
- 4 Press  /  to select a track number; then press **PROG** to confirm.
- 5 Repeat steps 2 to 4 to select and store all tracks to program.
- 6 Press **PROG** repeatedly to find a program, and press  to play the programmed track.
  - ↳ During play, [PROG] (program) is displayed.
  - To erase the program, press  for two times.



# 6 Play audio through Bluetooth

The unit uses Bluetooth wireless technology to stream music from your Bluetooth device to the system.

## Note

- Before you connect a Bluetooth device to this unit, familiarize yourself with the Bluetooth capabilities of the device.
- The effective operation range between the docking system and the paired phone is approximately 10 meters (30 feet).
- Any obstacle between the unit and the phone can reduce the operational range.
- Keep this unit away from other electronic devices that may cause interference.

- 1 Press **Bluetooth** to turn on Bluetooth function of the unit.  
↳ The Bluetooth indicator blinks.
- 2 On your Bluetooth, go to **[Settings]** (Settings) > **[Wireless and networks]** (Wireless and networks) > **[Bluetooth settings]** (Bluetooth settings).
- 3 Tap **[Bluetooth]** (Bluetooth) to turn on Bluetooth function of your device.

- 4 Tap **[Search for devices]** (Search for devices).  
↳ A Bluetooth pairing request appears.

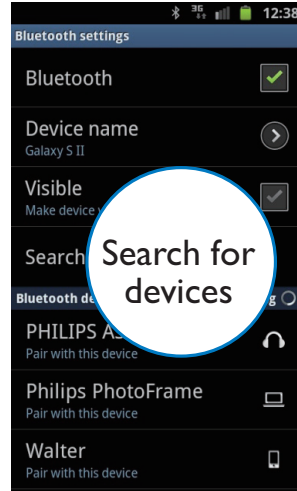

- 5 Tap **[Accept]** (Accept) to start pairing your device with the unit.  
↳ **[PHILIPS FWT6600]** (Philips FWT6600) is displayed.  
↳ If connected successfully, a different Bluetooth icon can be found on the top of the screen.

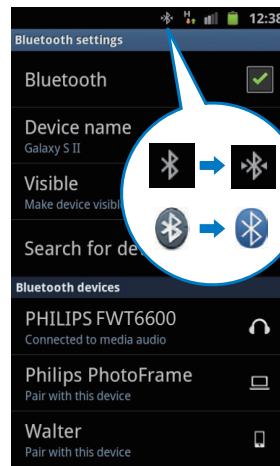

- ↳ After Bluetooth connection, you can enjoy audio on your phone through the unit.



#### Tip

- Different devices may have different way to enable Bluetooth function.

## 7 Listen to an external device

You can listen to an external audio device through the speakers of this unit.

---

### Listen to an MP3 player

- 1 Press **AUDIO IN** to select the MP3 link source.
- 2 Connect the supplied 3.5mm audio link cable to:
  - the **AUDIO IN** jack (3.5mm) on the unit.
  - the headphone jack on the MP3 player.
- 3 Start to play the device (refer to the device user manual).

---

### Listen to a PC

You can connect a PC or other audio devices.

- 1 Press **PC IN** repeatedly to select the PC IN source.
- 2 Connect the audio cables (white/red, not supplied) to:
  - the **PC IN** jacks (white/red) on the unit.
  - the headphone jack on the PC, or **AUDIO OUT** jacks on an external device.
- 3 Start to play the device (refer to the device user manual).

# 8 Listen to radio

## Tune to a radio station

- 1 Press **TUNER** repeatedly to select FM or AM.
- 2 Press and hold **◀▶** for more than 2 seconds.
  - ↳ [SEARCH] (search) is displayed.
  - ↳ The radio tunes to a station with strong reception automatically.
- 3 Repeat step 2 to tune to more stations.
  - To tune to a weak station, press **◀▶** repeatedly until you find optimal reception.

## Program radio stations manually

You can program a maximum of 30 FM and 10 AM preset radio stations.

- 1 Tune to a radio station.
- 2 Press **PROG** to activate program mode.
  - ↳ [PROG] (program) and a position number are displayed.
- 3 Press **ALB/PRESET+/-** to allocate a number to this radio station, then press **PROG** to confirm.
- 4 Repeat the above steps to program other stations.

### Tip

- To overwrite a programmed station, store another station in its place.

## Program radio stations automatically

In the tuner mode, press and hold **PROG** for more than 2 seconds to activate automatic program mode.

- ↳ [AUTO] (auto) is displayed.
- ↳ The unit automatically stores radio stations with sufficient signal strength.
- ↳ After all available radio stations are stored, the first stored radio station is broadcast automatically.

## Select a preset radio station

In tuner mode, press **ALB/PRESET+/-** to select a preset number:

### Tip

- Position the antenna as far as possible from TV, VCR or other radiation source.
- For optimal reception, fully extend and adjust the position of the antenna.

## Change AM tuning grid

In some countries, the AM radio frequency step between adjacent channels is 10 kHz (9 kHz in some areas).

- 1 Select the tuner source.
- 2 Press and hold **■** for more than 5 seconds.
  - ↳ The frequency step is changed to 9 kHz or 10 kHz.
  - ↳ All preset stations are erased and re-programmed in AM mode.

## 9 Adjust volume level and sound effect



### Note

- MAX sound and DSC (Digital Sound Control) cannot be activated at the same time.

---

### Adjust volume level

During play, press **VOL +/-** to increase/decrease the volume level.

---

### Mute sound

During play, press **MUTE** to mute/unmute sound.

---

### Boost loudness

MAX gives an instant boost to the sound power .

Press **MAX** to turn on or off the instant power boost.

- ↳ If MAX sound is activated, **MAX** is displayed.

---

### Select a preset sound effect

The DSC (Digital Sound Control) enables you to enjoy special sound effects.

During play, press **DSC** repeatedly to select:

- [TECHNO] (techno)
- [ROCK] (rock)
- [SAMBA] (samba)
- [JAZZ] (jazz)

- [POP] (pop)

---

### Enhance bass

The best DBB (Dynamic Bass Enhancement) setting is generated automatically for each DSC selection. You can manually select the DBB setting that best suits your listening environment.

- During play, press **DBB** repeatedly to select:
  - DBB 1
  - DBB 2
  - DBB 3
  - DBB OFF

---

### Virtual surround

You can enhance audio with a virtual surround sound effect.

Press and hold **DBB/IS** to turn on or off the incredible surround.

- ↳ If the incredible surround is activated, [INC SURR] (incredible surround) is displayed.

# 10 USB record

Audio CD tracks, MP3 files, radio, and audio from external devices are recorded in .mp3 format.

The first time you record to a USB device, a folder called 'PHILIPS' is automatically created in the USB device. Each time you record to a USB device, the recorded files are stored in a subfolder in the 'PHILIPS' folder. Files and subfolders are named numerically in the order in which they are created.

## Note

- This function is only available for **USB 2 PLAY/REC** socket.

## Record to a USB device

- 1 Connect a USB device to **USB 2 PLAY/REC** socket.
- 2 Prepare the source to record from.
  - Disc - Select the disc source and load a disc. You can select a track from which a recording starts.
  - Radio - Tune to a radio station.
  - AUDIO IN/PC IN - Select the MP3 link/PC IN source, and then connect and start to play an external device.
  - Karaoke - Singing during karaoke.
- 3 Press **USB RECORD** to start recording.
  - For discs, press **USB RECORD** repeatedly to select:
    - (A) [REC ONE] (record one): the first/current track is recorded.
    - (B) [REC ALL] (record all): all tracks/the remaining tracks are recorded.
  - ↳ Disc play starts automatically from the beginning of the disc/the selected track, and the recording starts.
  - To stop recording, press ■.

## Note

- If the USB device does not have enough memory to store the audio files, a message about a full memory is displayed.

## Schedule radio-to-USB record

Schedule radio recordings in advance and you can listen to your favorite programs at your convenience.

## Note

- A recording is activated only in the standby mode.
- The maximum length of a recording is 12 hours.



- 1 Ensure that you set the clock correctly.
- 2 Plug a USB device to **USB 2 PLAY/REC** socket.
- 3 Tune to a radio station.
- 4 Press **⏻** to switch to standby mode.
- 5 Press and hold **TIMER** for more than 2 seconds.
  - ↳ A prompt to select the source is displayed.
- 6 Press **TUNER** repeatedly to select FM or AM.
- 7 Press **USB RECORD**.
  - ↳ The start timer digits are displayed and begin to blink.
- 8 Press **ALB/PRESET+/-** to set the hour.
- 9 Press **◀/▶** to set the minute.
- 10 Press **TIMER** to confirm.
  - ↳ The end timer digits are displayed and begin to blink.
- 11 Press **ALB/PRESET+/-** to set the hour.
- 12 Press **◀/▶** to set the minute.

**13** Press **TIMER** to confirm.

- ↳  is displayed.
- ↳ At the scheduled times, the recording begins and ends automatically.
- ↳ When the recording ends, the unit switches to standby mode.

**To deactivate or reactivate a record timer**

**1** In the standby mode, press **TIMER** repeatedly.

- ↳ If the timer is activated,  is displayed.
- ↳ If the timer is deactivated,  disappears.

# 11 Other features



Tip

- Bluetooth and MP3 LINK/PC IN mode cannot be selected as the source of the alarm timer.
- If disc or USB source is selected but no audio file can be played, radio is activated automatically.

## Set the alarm timer

This music system can be used as an alarm clock. You can select disc, radio or USB as alarm source.

### Note

- If you have set a record timer and an alarm timer, only the latest timer shall be activated.

- 1 Ensure that you have set the clock correctly.
- 2 Press **⏻** to switch to standby mode.
- 3 Press and hold **SLEEP/TIMER** for more than 2 seconds.  
↳ A prompt to select the source is displayed.
- 4 Press **CD**, or **TUNER** or **USB** to select a source.
- 5 Press **SLEEP/TIMER** to confirm.  
↳ The clock digits are displayed and begin to blink.
- 6 Press **ALB/PRESET +/-** to set the hour.
- 7 Press **◀ / ▶** to set the minute.
- 8 Press **SLEEP/TIMER** to confirm.  
↳ The timer is set and activated.

### To deactivate or re-activate an alarm timer

- 1 In standby mode, press **SLEEP/TIMER** repeatedly.  
↳ If the timer is activated, **⌚** is displayed.  
↳ If the timer is deactivated, **⌚** disappears.

## Set the sleep timer

This unit can switch to standby automatically after a set period of time.

- 1 When the unit is turned on, press **SLEEP/TIMER** repeatedly to select a set period of time (in minutes).  
↳ When sleep timer is activated, **z z** is displayed.

### To deactivate sleep timer

- 1 Press **SLEEP/TIMER** repeatedly until **[OFF]** (off) is displayed.  
↳ When sleep timer is deactivated, **z z** disappears on the display.

## Karaoke

You can connect a microphone and sing along with a music source.

- 1 Turn **MIC 1 VOL/MIC 2 VOL** to the minimum level.
- 2 Connect a microphone to the microphone port on the unit.
- 3 Press **CD**, or **TUNER**, or **USB**, or **PC IN/AUDIO IN** to select the source, and start play.
- 4 Sing through the microphone.
  - To adjust the volume of the source, press **VOL +/-**.
  - To adjust the volume of the microphone, turn **MIC 1 VOL/MIC 2 VOL**.

---

## Copy files from USB 1 to USB 2

You can copy MP3 files from USB 1 device to USB 2 device.

- 1** Connect both USB device to **USB 1 PLAY** and **USB 2 PLAY/REC** sockets.
- 2** Press **USB** to select the **USB 1 PLAY** source.
- 3** Select an audio file.
- 4** Press **USB RECORD** to start copy.
  - You can press **USB RECORD** repeatedly to select:
    - **[COPY ONE]** (copy one): the first/current file is copied.
    - **[COPY ALL]** (copy all): all files/the remaining files are copied.
  - ↳ The track number and the percentage of copy progress are displayed.
  - Press **■** to stop copy.



# 12 Product information

## Note

- Product information is subject to change without prior notice.

## Specifications

### Amplifier

Total output power	1000W RMS @ 10% THD (-0.5dB)
Frequency response	60 Hz - 16kHz
Signal-to-noise ratio	>65 dBA
Aux input	1500mV/2000mV

### Disc

Laser type	Semiconductor
Disc diameter	12cm/8cm
Support disc	CD-DA, CD-R, CD-RW, MP3-CD
Audio DAC	24Bits / 44.1kHz
Total harmonic distortion	<1%
Frequency response	60Hz -16kHz
S/N ratio	>65 dBA

### Tuner

Tuning range	FM: 87.5 - 108MHz; AM: 531 - 1602kHz (9KHz); 530 - 1700kHz (10KHz)
Tuning grid	100kHz (FM); 9kHz/10kHz (AM)
Number of presets	40
FM	75ohm wire
AM	loop antenna

### Speakers

Speaker Impedance	2 x 3 ohm
Woofer	2 x 8"
Tweeter	2 x 2"
Output power	2 x 250W (1kHz, @10%THD, -0.5dB )
Dimensions (W x H x D)	258 x 452 x 388 mm
Weight	5 kg each

### Subwoofer

Speaker impedance	2 x 3 ohm
Speaker driver	10"
Output power	2 x 250W (63 Hz, @10% THD, -0.5dB )
Dimensions (W x H x D)	315 x 450 x 456 mm
Weight	10 kg

### General information-Specs

AC power	110 - 127/220 - 240V, 50/60Hz
Operation power consumption	150 W
Standby power consumption	<5W
USB direct	Version 2.0
Dimensions Main Unit (W x H x D)	265 x 377 x 423mm
Weight (without speakers)	6 kg

---

## USB playability information

### Compatible USB devices:

- USB flash memory (USB 2.0)
- USB flash players (USB 2.0)
- memory cards (requires an additional card reader to work with this unit)

### Supported formats:

- USB or memory file format FAT12, FAT16, FAT32 (sector size: 512 bytes)
- MP3 bit rate (data rate): 32-320 Kbps and variable bit rate
- Directory nesting up to a maximum of 8 levels
- Number of albums/ folders: maximum 99
- Number of tracks/titles: maximum 999
- ID3 tag v1.2 or later
- File name in Unicode UTF8 (maximum length: 128 bytes)

### Unsupported formats:

- Empty albums: an empty album is an album that does not contain MP3 files, and is not be shown in the display.
- Unsupported file formats are skipped. For example, Word documents (.doc) or MP3 files with extension .dlf are ignored and not played.
- AAC, WAV, PCM audio files
- WMA files

---

## Supported MP3 disc formats

- ISO9660, Joliet
- Maximum title number: 999 (depending on file name length)
- Maximum album number: 99
- Supported sampling frequencies: 32 kHz, 44.1kHz, 48 kHz
- Supported Bit-rates: 32-320 (kbps), variable bit rates
- ID3 tag v1.2 or later
- Directory nesting up to a maximum of 8 levels

---

## Maintenance

### Clean the cabinet

- Use a soft cloth slightly moistened with a mild detergent solution. Do not use a solution containing alcohol, spirits, ammonia or abrasives.

### Clean discs

- When a disc becomes dirty, clean it with a cleaning cloth. Wipe the disc from the centre out.

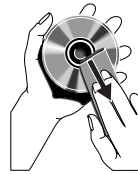

- Do not use solvents such as benzene, thinner, commercially available cleaners, or antistatic spray intended for analogue records.

### Clean the disc lens

- After prolonged use, dirt or dust may accumulate at the disc lens. To ensure good play quality, clean the disc lens with Philips CD lens cleaner or any commercially available cleaner. Follow the instructions supplied with cleaner.

# 13 Troubleshooting



## Caution

- Never remove the casing of this unit.

To keep the warranty valid, never try to repair the system yourself.

If you encounter problems when using this unit, check the following points before requesting service. If the problem remains unsolved, go to the Philips web site ([www.philips.com/support](http://www.philips.com/support)). When you contact Philips, ensure that your unit is nearby and the model number and serial number are available.

### No power

- Ensure that the AC power plug of the unit is connected properly.
- Ensure that there is power at the AC outlet.
- To save power, the unit switches to standby automatically 15 minutes after a play reaches the end and no control is operated.

### No sound or poor sound

- Adjust the volume.
- Check that the speakers are connected correctly.
- Check if the stripped speaker wires are clamped.

### Left and right sound outputs reversed

- Check the speaker connections and location.

### No response from the unit

- Disconnect and reconnect the AC power plug, then turn on the unit again.

### Remote control does not work

- Before you press any function button, first select the correct source with the remote control instead of the main unit.
- Reduce the distance between the remote control and the unit.
- Insert the batteries with their polarities (+/- signs) aligned as indicated.
- Replace the batteries.

- Aim the remote control directly at the sensor on the front of the main unit.

### No disc detected

- Insert a disc.
- Check if the disc is inserted upside down.
- Wait until the moisture condensation at the lens has cleared.
- Replace or clean the disc.
- Use a finalized CD or correct format disc.

### Cannot display some files in USB device

- The number of folders or files in the USB device has exceeded a certain limit. This phenomenon is not a malfunction.
- The formats of these files are not supported.

### USB device not supported

- The USB device is incompatible with the unit. Try another one.

### Poor radio reception

- Increase the distance between the unit and your TV or VCR.
- If the signal is too weak, adjust the antenna or connect an external antenna for better reception.

### Clock/timer setting erased

- Power has been interrupted or the power cord has been disconnected.
- Reset the clock/timer.

### Timer does not work

- Set the clock correctly.
- Switch on the timer.

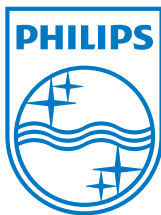

Specifications are subject to change without notice  
© 2013 Koninklijke Philips Electronics N.V.  
All rights reserved.

FWT6600\_x78\_UM\_EN\_V2.0

