

Register your product and get support at

[www.philips.com/welcome](http://www.philips.com/welcome)

DVP3520



EN	User manual	3
DA	Brugervejledning	19
DE	Benutzerhandbuch	35
EL	Εγχειρίδιο χρήσης	53
ES	Manual del usuario	73
FI	Käyttöopas	91
FR	Mode d'emploi	107

IT	Manuale utente	125
NL	Gebruiksaanwijzing	143
PL	Instrukcja obsługi	161
PT	Manual do utilizador	179
SV	Användarhandbok	197
TR	Kullanım kılavuzu	213

# PHILIPS

## LASER

### CAUTION:

USE OF CONTROLS OR ADJUSTMENTS OR PERFORMANCE OF PROCEDURES OTHER THAN THOSE SPECIFIED HEREIN MAY RESULT IN HAZARDOUS RADIATION EXPOSURE.

### CAUTION:

VISIBLE AND INVISIBLE LASER RADIATION WHEN OPEN AND INTERLOCK DEFEATED. DO NOT STARE INTO BEAM.

### LOCATION:

INSIDE, NEAR THE DECK MECHANISM.

## Italia

### DICHIARAZIONE DI CONFORMITA'

Si dichiara che l'apparecchio DVP3520, Philips risponde alle prescrizioni dell'art. 2 comma 1 del D.M. 28 Agosto 1995 n.548.

Fatto a Eindhoven

Philips Consumer Lifestyles  
Philips, Glaslaan 25616 JB Eindhoven,  
The Netherlands

This product is in compliance with the **EEE directive**.

**EEE yönergesine uygundur.**

## Norge

Typeskilt fi nnes på apparatens underside.

**Observer: Nettbryteren er sekundert innkoplet. Den innebygde nettdelen er derfor ikke frakoplet nettet så lenge apparatet er tilsluttet nettkontakten.**

For å redusere faren for brann eller elektrisk støt, skal apparatet ikke utsettes for regn eller fuktighet.

## DK

Advarsel: Usynlig laserstråling ved åbning når sikkerhedsafbrydere er ude af funktion. Undgå udsættelse for stråling.

Bemærk: Netafbryderen er sekundært indkoblet og afbryder ikke strømmen fra nettet. Den indbyggede netdel er derfor tilsluttet til lysnettet så længe netstikket sidder i stikkontakten.

## S

Klass 1 laserapparat

Varning! Om apparaten används på annat sätt än i denna bruksanvisning speci fi cerats, kan användaren utsättas för osynlig laserstråling, som överskrider gränsen för laserklass 1.

Observera! Stömbrytaren är sekundärt kopplad och bryter inte strömmen från nätet. Den inbyggda nettdelen är därför ansluten till elnätet så länge stickproppen sitter i vägguttaget.

## SF

Luokan 1 laserlaite

Varoitus! Laitteen käyttäminen muulla kuin tässä käyttöohjeessa mainitulla tavalla saattaa altistaa käyttäjän turvallisuusluokan 1 yllittävälle näkymättömälle lasersäteilylle.

Oikeus muutoksiin varataan. Laite ei saa olla alttiina tippu- ja roiskevedelle. Huom. Toiminnanvalitsin on kytketty toisiopuolelle, eikä se kytke laitetta irti sähköverkosta.

Sisäänrakennettu verkko-osa on kytketty sähköverkkoon aina silloin, kun pistoke on pistorasissa.

**Producent zastrzega możliwość wprowadzania zmian technicznych.**

---

## Trademark notice



Manufactured under license from Dolby Laboratories. Dolby and the double-D symbol are trademarks of Dolby Laboratories.



Windows Media and the Windows logo are trademarks, or registered trademarks of Microsoft Corporation in the United States and/or other countries.



**ABOUT DIVX VIDEO:** DivX® is a digital video format created by DivX, Inc. This is an official DivX Certified device that plays DivX video. Visit [www.divx.com](http://www.divx.com) for more information and software tools to convert your files into DivX video.

**ABOUT DIVX VIDEO-ON-DEMAND:** This DivX Certified® device must be registered in order to play DivX Video-on-Demand (VOD) content. To generate the registration code, locate the DivX VOD section in the device setup menu. Go to [vod.divx.com](http://vod.divx.com) with this code to complete the registration process and learn more about DivX VOD.

DivX®, DivX Certified® and associated logos are registered trademarks of DivX, Inc. and are used under license.



The USB-IF Logos are trademarks of Universal Serial Bus Implementers Forum, Inc.

## Contents

---

<b>1</b>	<b>Important</b>	4
	Safety and important notice	4
<b>2</b>	<b>Your DVD player</b>	5
	Playable media	5
	Product overview	5
<b>3</b>	<b>Connect</b>	6
	Connect audio/video cables	6
	Route audio to other devices	7
	Connect USB flash drive	7
	Connect power	8
<b>4</b>	<b>Get started</b>	8
	Prepare the remote control	8
	Find the TV input channel	8
	Select menu display language	8
	Turn on progressive scan	8
<b>5</b>	<b>Play</b>	9
	Play a disc	9
	Play video	9
	Play music	10
	Play photo	11
	Play musical slideshow	12
	Play from a USB flash drive	12
<b>6</b>	<b>Advanced features</b>	12
	Media copy	12
	Create MP3 files	12
<b>7</b>	<b>Adjust settings</b>	13
	General setup	13
	Audio setup	14
	Video setup	15
	Preferences	15
<b>8</b>	<b>Additional information</b>	17
	Update software	17
	Care	17
	Specifications	17
<b>9</b>	<b>Troubleshooting</b>	18

# 1 Important

## Safety and important notice



### Warning

- Risk of overheating! Never install the product in a confined space. Always leave a space of at least 4 inches around the product for ventilation. Ensure curtains or other objects never cover the ventilation slots on the product.
- Never place the product, remote control or batteries near naked flames or other heat sources, including direct sunlight.
- Avoid high temperature, moisture, water and dust.
- This unit must not be exposed to dripping or splashing.
- Never place any object or items that can damage this unit (e.g., liquid filled objects, lighted candles).
- Never place this product on other electrical equipment.
- Keep away from this product during lightning storms.
- Where the mains plug or an appliance coupler is used as the disconnect device, the disconnect device shall remain readily operable.
- Visible and invisible laser radiation when open. Avoid exposure to beam.



This product complies with the radio interference requirements of the European Community.

## About Progressive Scan

Consumers should note that not all high definition television sets are fully compatible with this product and may cause artifacts to be displayed in the picture. In case of 525 or 625 progressive scan picture problems, it is recommended that the user switch the connection to the 'standard definition' output. If there are questions regarding our TV set compatibility with this model 525p and 625p DVD player, please contact our customer service center.

## Disposal of your old product and batteries



Your product is designed and manufactured with high quality materials and components, which can be recycled and reused.



When this crossed-out wheeled bin symbol is attached to a product it means that the product is covered by the European Directive 2002/96/EC. Please inform yourself about the local separate collection system for electrical and electronic products.

Please act according to your local rules and do not dispose of your old products with your normal household waste.

Correct disposal of your old product helps to prevent potential negative consequences for the environment and human health.



Your product contains batteries covered by the European Directive 2006/66/EC, which cannot be disposed with normal household waste.

Please inform yourself about the local rules on separate collection of batteries because correct disposal helps to prevent negative consequences for the environmental and human health.

## Copyright notice



**Be responsible  
Respect copyrights**

This item incorporates copy protection technology that is protected by U.S. patents and other intellectual property rights of Rovi Corporation. Reverse engineering and disassembly are prohibited.

**CLASS 1  
LASER PRODUCT**

## 2 Your DVD player

Congratulations on your purchase, and welcome to Philips! To fully benefit from the support that Philips offers, register your product at [www.philips.com/welcome](http://www.philips.com/welcome).

### Playable media

This product can play:

- DVD, DVD-Video, DVD+R/+RW, DVD-R/-RW, DVD+R/-R DL (Dual Layer)
- Video CD/SVCD
- Audio CD, CD-R/CD-RW
- MP3 media, WMA media, DivX (Ultra) media, JPEG files
- USB flash drive

### Region codes





You can play discs with the following region codes.

DVD region code	Countries
	Europe

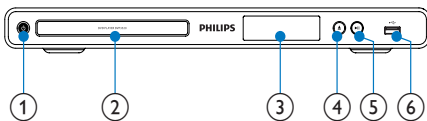
### Product overview



#### Main unit

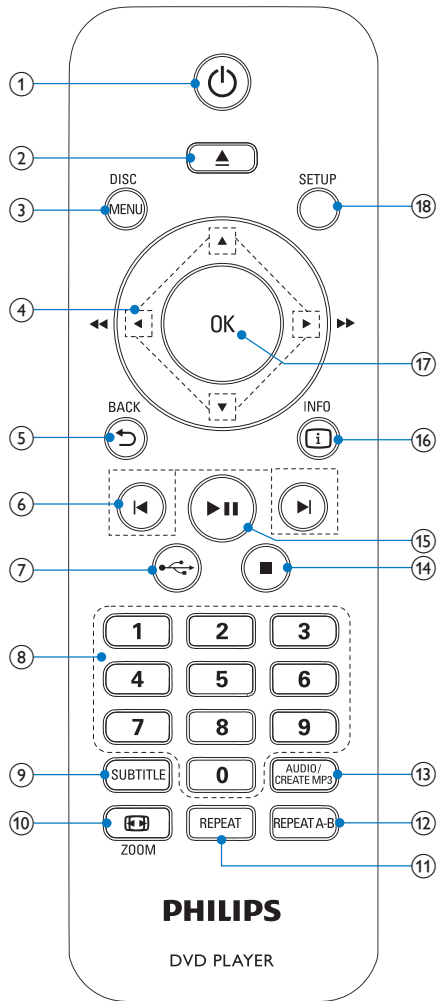

-  Turn on the unit or switch to standby.
- Disc compartment**
- Display panel**
- 
  - Open or close the disc compartment.
- 
  - Start, pause or resume disc play.
-  (USB) jack
  - Connect a USB flash drive.

#### Remote control



-  Turn on the unit or switch to standby.
-  Open or close the disc compartment.

- ③ **DISC MENU**
- Access or exit the disc menu.
  - Switch to the disc mode.
  - During the play of a photo slideshow, switch between the Fun Mode and Simple Mode.
  - For VCD and SVCD: turn on or off PBC (playback control).
- ④ **▲▼◀▶**
- Navigate the menus.
  - Search fast-forward (▶) or fast-backward (◀):
  - Search slow-forward (▲) or slow-backward (▼).
- ⑤ **↶ BACK**
- Return to the previous display menu.
- ⑥ **◀▶**
- Skip to the previous or next title, chapter, or track.
- ⑦ **🔌**
- Switch to the USB mode.
- ⑧ **Numeric buttons**
- Select an item to play.
- ⑨ **SUBTITLE**
- Select a subtitle language on a disc.
  - Access the menu of copying/deleting USB audio files.
- ⑩ **📺 ZOOM**
- Fit the picture display to the TV screen.
  - Zoom the picture in or out.
- ⑪ **REPEAT**
- Select various repeat play modes.
- ⑫ **REPEAT A-B**
- Repeat play for a specific section.
- ⑬ **AUDIO/CREATE MP3**
- Select an audio language or channel on a disc.
  - Access the menu of creating MP3 files.
- ⑭ **■**
- Stop play.
- ⑮ **⏸**
- Start, pause or resume disc play.
- ⑯ **ℹ INFO**
- For discs: access the play options or display the current disc status.
  - For slideshows: display a thumbnail view of photo files.
- ⑰ **OK**
- Confirm an entry or selection.
- ⑱ **SETUP**
- Access or exit the setup menu.

## 3 Connect

All audio/video cables are sold separately.

Make the following connections to use this product.

### Basic connections:

- Video
- Audio

### Optional connections:

- Route audio to other devices:
  - Digital amplifier/receiver
  - Analog stereo system
- USB flash drive



### Note

- Refer to the type plate at the back or bottom of the product for identification and supply ratings.
- Before you make or change any connections, ensure that all the devices are disconnected from the power outlet.

## Connect audio/video cables

Connect this product to TV to view disc play. Select the best video connection that TV can support.

- **Option 1:** Connect to component video jacks (for a standard TV or Progressive Scan TV).
- **Option 2:** Connect to scart jack (for a standard TV).
- **Option 3:** Connect to video (CVBS) jack (for a standard TV).



### Note

- You must connect this product directly to a TV.

## Option 1: Connect to component video jacks

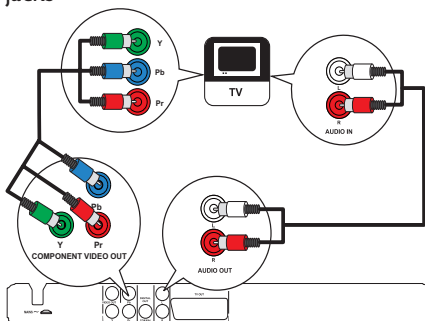

- 1 Connect the component video cables to:
  - the **Y Pb Pr** jacks on this product.
  - the **COMPONENT VIDEO** input jacks on the TV.
- 2 Connect the audio cables to:
  - the **AUDIO OUT L/R** jacks on this product.
  - the audio input jacks on the TV.

### Option 2: Connect to scart jack

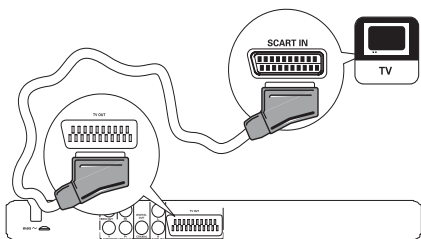

- 1 Connect a scart cable to:
  - the **TV OUT** jack on this product.
  - the scart input jack on the TV.

### Option 3 : Connect to video (CVBS) jack

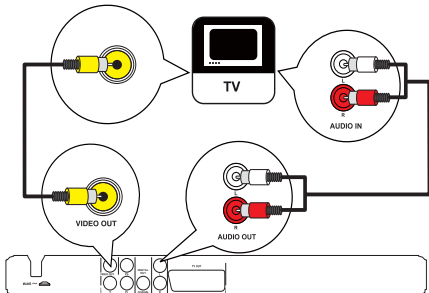

- 1 Connect a composite video cable to:
  - the **VIDEO OUT** jack on this product.
  - the video input jack on the TV.
- 2 Connect the audio cables to:
  - the **AUDIO OUT L/R** jacks on this product.
  - the audio input jacks on the TV.

## Route audio to other devices

Route the audio from this product to other devices to enhance audio play.

## Connect to digital amplifier/receiver

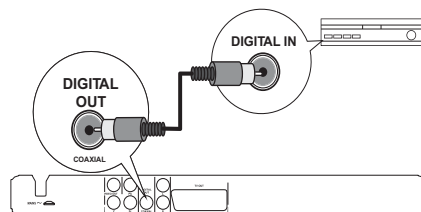

- 1 Connect a coaxial cable to:
  - the **COAXIAL** jack on this product.
  - the **COAXIAL/DIGITAL** input jack on the device.

## Connect analogue stereo system

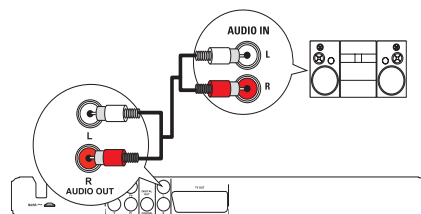

- 1 Connect the audio cables to:
  - the **AUDIO OUT L/R** jacks on this product.
  - the audio input jacks on the device.

## Connect USB flash drive

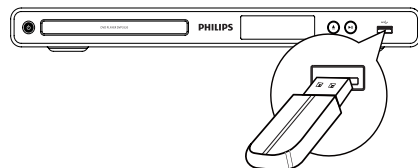

- 1 Connect a USB flash drive to the  jack on this product.

### Note

- This product can only play/view MP3, WMA, DivX (Ultra) or JPEG files that are stored on a USB flash drive.
- Press the  button to access the content and play the files.

## Connect power

### Caution

- Risk of product damage! Ensure that the power supply voltage corresponds to the voltage printed on the back of the unit.
- Before connecting the AC power cord, ensure you have completed all other connections.

### Note

- The type plate is located on the back of the product.

- 1 Connect the AC power cable to the wall socket.  
↳ The player is ready to be set up for use.

## 4 Get started

### Prepare the remote control

- 1 Press and push the battery compartment to slide it open (see "1" in the illustration).
- 2 Insert two AAA batteries with correct polarity (+/-) as indicated.
- 3 Push and slide back the battery compartment (see "3" in the illustration).

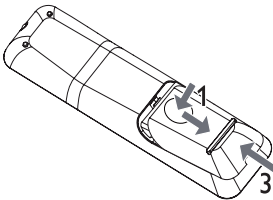





### Note

- If you are not going to use the remote control for a long time, remove the batteries.
- Do not mix batteries (old and new or carbon and alkaline, etc.).
- Batteries contain chemical substances, so they should be disposed of properly.

### Find the TV input channel

- 1 Press  $\odot$  to turn on this product.
- 2 Turn on the TV and switch to the video input channel (refer to the TV user manual on how to select the A/V input channel).

## Select menu display language





General Setup		
   	Disc Lock	<input type="radio"/> English
	<b>OSD Language</b>	<input type="radio"/> Français
	Sleep Timer	<input type="radio"/> Deutsch
	Auto Standby	<input type="radio"/> Italiano
	DivX(R) VOD Code	<input type="radio"/> Español
	<input type="radio"/> Português	
	<input type="radio"/> Netherlands	
	<input type="radio"/> Dansk	

- 1 Press **SETUP**.  
↳ **[General Setup]** menu is displayed.
- 2 Select **[OSD Language]**, and then press  $\blacktriangleright$ .
- 3 Press  $\blacktriangleup$  to select a language, and then press **OK**.

### Turn on progressive scan

### Note

- To use the progressive scan feature, you must connect a progressive scan TV with the component video jacks (see "Connect" > "Connect audio/video cables" > "Option 1: Connect to the component video jacks" for details).

Video Setup		
   	TV System	<input type="radio"/> On
	TV Display	<input type="radio"/> Off
	<b>Progressive</b>	
	Picture Setting	
	My Wallpaper	
	Component Video	

- 1 Turn on the TV to the correct viewing channel for this product.
- 2 Press **SETUP**.
- 3 Press  $\blacktriangledown$  to select **[Video Setup]**.
- 4 Select **[Component Video]** > **[Interlaced]**, and then press **OK**.
- 5 Select **[Progressive]** > **[On]**, and then press **OK**.  
↳ A warning message is displayed.
- 6 To proceed, select **[Ok]** and then press **OK**.  
↳ The progressive setup is complete.



### Note

- If a blank/distorted screen is displayed, wait for 15 seconds for the auto recovery.
- If no picture is displayed, turn off the progressive scan mode as follows:
  - 1) Press **▲** to open the disc compartment.
  - 2) Press the **Numeric button '1'**.

- 7 Press **SETUP** to exit the menu.
- 8 You can now turn on the progressive scan mode on the TV (see the TV user manual).

### Note

- During play, when the progressive scan mode is on for both this product and the TV, distorted picture may display. In this case, turn off the progressive scan feature on both this product and the TV.

## 5 Play

### Play a disc

#### ! Caution

- Do not place any objects other than discs into the disc compartment.
- Do not touch the disc optical lens inside the disc compartment.

- 1 Press **▲** to open the disc compartment.
- 2 Insert a disc with its label facing up.
- 3 Press **▲** to close the disc compartment and start disc play.
  - To view disc play, turn on the TV to the video input channel.
  - To stop disc play, press **■**.

### Note

- Check the types of discs supported (see "Your DVD player" > "Playable media").
- If the password entry menu is displayed, enter the password before you can play the locked or restricted disc (see "Adjust settings" > "Preferences" > **[Parental Control]**).
- If you pause or stop a disc, the screen saver appears after 5 minutes of inactivity. To deactivate the screen saver, press **DISC MENU**.
- After you pause or stop a disc and no button is pressed within 15 minutes, this product automatically switches to standby.

### Play video

#### Note

- Some operations may not work with some discs. See the information accompanying the disc for details.

### Control video play

- 1 Play a title.
- 2 Use the remote control to control the play.

Button	Action
<b>▶  </b>	Start, pause or resume disc play.
<b>■</b>	Stop disc play.
<b>◀▶</b>	Skip to a previous/next title or chapter.
<b>◀◀▶▶</b>	Search fast-backward or fast-forward. Press repeatedly to change the search speed.
<b>▲, ▼</b>	Search slow-forward or slow-backward. Press repeatedly to change the search speed. For VCD/SVCD, slow-backward search is not available.
<b>AUDIO/CREATE MP3</b>	Select an audio language or channel available on a disc.
<b>SUBTITLE</b>	Select a subtitle language available on a disc.
<b>REPEAT</b>	Select or turn off repeat mode. Repeat options may vary from disc type.
<b>REPEAT A-B</b>	Repeat a specific section within a track/disc.
<b>◻ ZOOM (Screen fit)</b>	Fit the picture format to the TV screen. Press repeatedly until the image is scaled to fit to the TV screen.
<b>◻ ZOOM</b>	Toggle between screen aspect ratio and different zoom factor. To pan through the zoomed image, press the <b>Navigation buttons</b> .
<b>ⓘ INFO</b>	Access the play options and display the current disc status.

### Access DVD menu

- 1 Press **DISC MENU** to access the disc root menu.
- 2 Select a play option, then press **OK**.
  - In some menus, press the **Numeric buttons** to input your selection.

---

## Access VCD menu

The PBC (playback control) feature is available for VCD/SVCD, which can display the contents menu for you to select a play option. The PBC is on by default in the factory.



### Note

- See "Adjust settings" > "Preferences" > [PBC] on how to turn PBC on or off.

- 1 Display the contents menu via one of the following ways:
  - If PBC is on, load in a VCD/SVCD.
  - During play with PBC on, press **↩ BACK**.
- 2 Press the **Numeric buttons** to select a play option, and then press **OK** to start play.
  - If PBC is turned off, it skips the menu display and starts play from the first track.

---

## Preview disc contents

- 1 During play, press **ⓘ INFO**.
  - ↳ The disc status menu is displayed.
- 2 Select **[Preview]**, and then press **▶**.
- 3 Select a preview option, and then press **OK**.
  - ↳ A thumbnails preview screen is displayed.
    - To go to the next/previous preview screen, select **[Prev]** or **[Next]**, and then press **OK**.
    - To start play, press **OK** at the selected thumbnail picture.

---

## Skip play to a specific time

- 1 During play, press **ⓘ INFO**.
  - ↳ The disc status menu is displayed.
- 2 Select an option for the current elapsed playing time, and then press **▶**.
  - **[TT Time]** (title time)
  - **[CH Time]** (chapter time)
  - **[Disc Time]**
  - **[Track Time]**
- 3 Press the **Numeric buttons** to enter the time to skip to, then press **OK**.

---

## Display play time

- 1 During play, press **ⓘ INFO**.
  - ↳ The disc status menu is displayed.
- 2 Select **[Time Disp.]**, and then press **▶**.
  - ↳ The display options vary from disc type.
- 3 Select an option, and then press **OK**.

---

## View DVD play from different angles

- 1 During play, press **ⓘ INFO**.
  - ↳ The disc status menu is displayed.
- 2 Select **[Angle]**, and then press **▶**.
- 3 Press the **Numeric buttons** to change the angle.
  - ↳ Play changes to the selected angle.



### Note

- Applicable only to discs that contain multi-angle scenes.

---

## Repeat play for a specific section

- 1 During play, press **REPEAT A-B** at the start point.
- 2 Press **REPEAT A-B** again to set the end point.
  - ↳ Repeat play starts.
- 3 To cancel repeat play, press **REPEAT A-B** again.



### Note

- The marked section for repeat play is only possible within a track/title.

---

## Play DivX® (Ultra) video

DivX® (Ultra) video is a digital media format that retains high quality despite a high rate of compression. You can enjoy DivX® (Ultra) video on this DivX (Ultra) certified product.

- 1 Insert a disc or USB flash drive that contains the DivX (Ultra) videos.
  - For USB, press **⏪**.
  - ↳ A contents menu is displayed.
- 2 Select a title to play, then press **OK**.
  - You may select subtitle/audio language.



### Note

- You can only play DivX (Ultra) video that is rented or purchased with the DivX registration code of this product (see "Adjust Settings" > "General Setup" > [DivX(R) VOD Code]).

---

## Play music

---

### Control a track

- 1 Play a track.
- 2 Use the remote control to control the play.

Button	Action
	Start, pause or resume disc play.
	Stop disc play.
	Skip to a previous/next track.
	Select an item to play.
	Searches fast-backward or fast-forward. Press repeatedly to change the search speed.
REPEAT	Select or turn off repeat mode. Repeat options may vary from disc type.

### Quick skip play

- 1 During play, press **INFO** repeatedly to select an option.

Display	Action
[Disc Go To]	Skip play to a specific time within the disc.
[Track Go To]	Skip play to a specific time within a track.
[Select Track]	Skip play to a specific track number.

- 2 Press the **numeric buttons** to change the time/number to skip to.

### Play MP3/WMA music

MP3/WMA is a type of highly compressed audio file (files with .mp3, .wma extensions).

- 1 Insert a disc or USB that contains the MP3/WMA music.
  - For USB, press .
  - ↳ A contents menu is displayed.
- 2 If play does not automatically start, select a track to play.
  - To select another track/folder, press **▲▼**, then press **OK**.

### Note

- For disc recorded in multiple sessions, only the first session is played.
- For a WMA file that is protected by Digital Rights Management (DRM), it cannot be played on this product.
- This product does not support MP3PRO audio format.
- For any special character that is present in the MP3 track name (ID3) or album name, it might not be displayed correctly on the screen because these characters are not supported.
- Folders/files that exceed the supported limit of this product cannot be displayed or played.

## Play photo

### Play photo as slideshow

You can play JPEG photos (files with .jpeg or .jpg extensions).

- 1 Insert a disc or USB that contains the JPEG photos.
  - For USB, press .
  - ↳ Slideshow begins (for Kodak disc), or a contents menu (for JPEG disc) is displayed.
- 2 Select a photo, and then press **OK** to start slideshow.
  - ↳ For a photo recorded with the "exif" format, the display orientation is automatically optimized.
- To display photos in color (Fun Mode) or in black and white (Simple Mode), press **DISC MENU**.
- To preview the photos in thumbnail, press **INFO**.
  - To select a photo, press the **Navigation buttons**.
  - To enlarge the selected photo and start slideshow, press **OK**.
  - To return to the menu, press **BACK**.

### Note

- It may require longer time to display the disc content on the TV due to the large number of songs/photos compiled onto one disc/USB flash drive.
- If the JPEG photo is not recorded with an "exif" type file, the actual thumbnail picture cannot be shown on the screen. It is replaced by a 'blue mountain' thumbnail picture.
- This product can only display digital camera pictures according to the JPEG-EXIF format, typically used by almost all digital cameras. It cannot display Motion JPEG, or pictures in formats other than JPEG, or sound clips associated with pictures.
- Folders/files that exceed the supported limit of this product cannot be displayed or played.

---

## Control photo play

- 1 Play a photo slideshow.
- 2 Use the remote control to control the play.

Button	Action
◀/▶	Rotate a photo anti-clockwise/ clockwise.
▲/▼	Rotate a photo horizontally/ vertically.
📐 ZOOM	Zoom in or out of a photo. Play pauses in zoom mode.
■	Stop a play.

---

## Play musical slideshow

Create a musical slideshow to play MP3/WMA music files and JPEG photo files simultaneously.

### Note

- To create a musical slideshow, you must store the MP3/WMA and JPEG files on the same disc/USB flash drive.

- 1 Play MP3/WMA music.
  - 2 Press **↩** BACK to return to the main menu.
  - 3 Navigate to the photo folder/album and press **OK** to start slideshow play.
    - ↳ Slideshow begins and continues till the end of the photo folder or album.
    - ↳ Audio continues to play until the end of the disc.
      - To stop slideshow play, press **■**.
      - To stop music play, press **■** again.
- 

## Play from a USB flash drive

### Note

- This product plays/views MP3, WMA, DivX (Ultra) or JPEG files that are stored on a USB flash drive.

- 1 Connect a USB flash drive to the **🔌** jack on this product.
- 2 Press the **🔌** button.
  - ↳ A contents menu is displayed.
- 3 If play does not start automatically, select a file to play.
  - For more information, see the chapters "Play music", "Play photo" and "Play video" for details.

- 4 To stop play, press **■**.
  - To switch to the disc mode, press the **🔌** button.

---

## 6 Advanced features

### Media copy

You can copy files (such as MP3, WMA or JPEG) from disc to a USB flash drive.

- 1 Insert a disc that contains the MP3/WMA/JPEG files.
- 2 In the stop mode, connect the USB flash drive to the **🔌** jack on this product.
- 3 Select a file to copy, then press **SUBTITLE**.
- 4 Select **[Yes]** in the menu, then press **OK**.

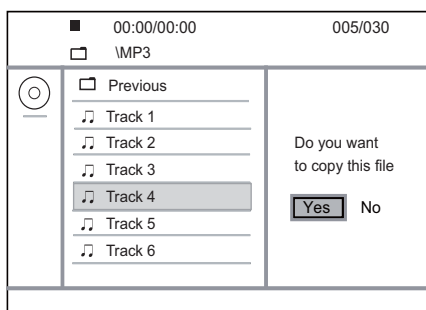

- ↳ Once complete, a new folder is created automatically in the USB flash drive to store all the new files.

- 5 To stop copy progress, press **■**, then press **OK**.

### Note

- When you copy, never press any button.
- Copy-protected media cannot be copied.

---

## Create MP3 files

With this product, you can convert audio CDs into MP3 audio files. The created MP3 audio files are saved in the USB flash drive.

- 1 Insert an audio CD.
- 2 Connect a USB flash drive to the **🔌** jack on this product.
- 3 During disc play, press **AUDIO/CREATE MP3**.
  - ↳ The MP3 creation menu is displayed.

- 4 Select **[Yes]** in the menu, and then press **OK**.

Create MP3			
OPTIONS		TRACK	
<b>Speed</b> Normal		<input type="radio"/> Track01	04:14
Bitrate 128kbps		<input type="radio"/> Track02	04:17
CRT ID3 Yes		<input type="radio"/> Track03	03:58
Device USB 1		<input type="radio"/> Track04	04:51
SUMMARY		<input type="radio"/> Track05	03:53
Press <b>[OK]</b> button to change speed.		<input type="radio"/> Track06	04:09
		<input type="radio"/> Track07	04:38
Start	Exit	Select all	Deselect all

- 5 Select a conversion option in the **[OPTIONS]** panel, and then press **OK** repeatedly to select an item.

Option	Description
<b>[Speed]</b>	Select a copying speed.
<b>[Bitrate]</b>	Select a quality level. Higher bitrate for better sound quality and bigger file size.
<b>[CRT ID3]</b>	Copy track information into the MP3 file.
<b>[Device]</b>	The created files can only be saved in a USB flash drive.

- 6 Press **▶** to access the **[TRACK]** panel.
- 7 Select an audio track, and then press **OK**.
- To select another track, repeat step 7.
  - To select all tracks, select **[Select all]** in the menu, and press **OK**.
  - To deselect all tracks, select **[Deselect all]** in the menu, and press **OK**.
- 8 Select **[Start]** in the menu, and then press **OK** to start to convert.
- ↳ Once complete, a new folder is created automatically in the USB flash drive to store all the new MP3 files.
- To exit the menu, select **[Exit]**, and then press **OK**.

### Note





- When you convert, never press any button.
- DTS CDs and copy-protected CDs cannot be converted.
- Writer-protected or password-protected USB flash drives cannot be used to store MP3 files.

## 7 Adjust settings

### Note

- If the setup option is grayed out, it means the setting cannot be changed at the current state.

## General setup

General Setup	
	Disc Lock
	OSD Language
	Sleep Timer
	Auto Standby
	DivX(R) VOD Code

- Press **SETUP**.  
↳ **[General Setup]** menu is displayed.
- Press **▶**.
- Select an option, and then press **OK**.
- Select a setting, and then press **OK**.
  - To return to the previous menu, press **◀**.
  - To exit the menu, press **SETUP**.

### [Disc Lock]

Set the play restriction for a disc which is loaded in the disc compartment (maximum 20 discs can be locked).

- [Lock]** - Restrict the access to the current disc. At the next time when you want to play this disc or unlock it, you need to enter the password.
- [Unlock]** - Play all discs.

### [OSD Language]

Select a language for on-screen menu.

### [Sleep Timer]

Switch automatically to standby at the preset time.

- [Off]** - Disable sleep mode.
- [15 Mins]**, **[30 Mins]**, **[45 Mins]**, **[60 Mins]** - Select the countdown time for this product to switch to standby.

### [Auto Standby]

Turn on/off the auto standby mode.

- [On]** - Switch to standby after 15 minutes of inactivity (for example, in pause or stop mode).
- [Off]** - Disable the auto standby mode.

## [DivX(R) VOD Code]





Display the DivX® registration code and deregistration code.

- **[Deregistration]** - Obtain a deregistration code to cancel the registration of this product on website.
- **[Registration]** - Obtain a registration code to register this product on website.

### Note

- Use this product's DivX registration code when you rent or purchase video from [www.divx.com/vod](http://www.divx.com/vod). The DivX videos rented or purchased through the DivX® VOD (Video On Demand) service can be played only on the device to which it is registered.

## Audio setup

Audio Setup	
	Analogue Output _____
	Digital Audio _____
	Volume _____
	Sound Mode _____
	CD Upsampling _____
	Night Mode _____

- 1 Press **SETUP**.  
↳ **[General Setup]** menu is displayed.
- 2 Press **▼** to select **[Audio Setup]**, and then press **▶**.
- 3 Select an option, and then press **OK**.
- 4 Select a setting, and then press **OK**.
  - To return to the previous menu, press **◀**.
  - To exit the menu, press **SETUP**.

### [Analogue Output]

Select an analogue setting based on the audio device that is connected through the analogue audio jack.

- **[LT/RT]** - For the surround sound output through two speakers.
- **[Stereo]** - For the stereo output.

### [Digital Audio]

Select a digital setting based on the digital amplifier/receiver that is connected through the digital jack (coaxial/digital).

- **[Digital Output]** - Select a type of digital output.
  - **[All]** - Support multi-channel audio formats.
  - **[Off]** - Disable digital output.

- **[PCM Only]** - Downmix to two-channel audio format.
- **[LPCM Output]** - Select the LPCM (Linear Pulse Code Modulation) output sampling rate.
  - **[48kHz]** - For discs recorded at sampling rate of 48 kHz.
  - **[96kHz]** - For discs recorded at sampling rate of 96 kHz.

### Note

- **[LPCM Output]** setting is only available if the **[Digital Output]** is set to **[PCM Only]**.
- The higher the sampling rate, the better the sound quality.

### [Volume]

Set the default volume level when you play a disc.

1. Press **OK**.
2. Press **◀▶** to set the volume.
3. Press **OK** to confirm and exit.

### [Sound Mode]

Select a preset sound effect to enhance the audio output.

- **[3D]** - Select a virtual surround sound effect that is produced from the left and right audio channels.
- **[Movie Mode]** - Select a sound effect for movies.
- **[Music Mode]** - Select a sound effect for music.

### [CD Upsampling]

For better sound quality in stereo mode, convert the music CD to a higher sampling rate.

- **[Off]** - Turn off CD-upsampling.
- **[88.2kHz]** - Convert to twice the original sampling rate.
- **[176.4kHz]** - Convert to four times the original sampling rate.

### [Night Mode]







Make loud sound level softer and soft sound level louder so that you can watch the DVD movies at a low volume, without disturbing others.

- **[On]** - Enjoy quiet viewing at night.
- **[Off]** - Enjoy surround sound with a full dynamic range.

### Note

- Applicable only to Dolby Digital encoded DVDs.

## Video setup

Video Setup		
	TV System	_____
	TV Display	_____
	Progressive	_____
	Picture Setting	_____
	My Wallpaper	_____
	Component Video	_____

- 1 Press **SETUP**.  
↳ **[General Setup]** menu is displayed.
- 2 Press **▼** to select **[Video Setup]**, and then press **►**.
- 3 Select an option, and then press **OK**.
- 4 Select a setting, and then press **OK**.
  - To return to the previous menu, press **◀**.
  - To exit the menu, press **SETUP**.

### [TV System]

Change this setting if the video does not appear correctly. By default, this setting matches the most common setting for TVs in your country.

- **[PAL]** - For a PAL-system TV.
- **[Multi]** - For TV that is compatible with both PAL and NTSC.
- **[NTSC]** - For an NTSC-system TV.

### [TV Display]

Select a display format:



- **[4:3 Pan Scan]** - For a 4:3 screen TV: full-height display with the trimmed sides.
- **[4:3 Letter Box]** - For a 4:3 screen TV: wide-screen display with black bars on the top and bottom of the screen.
- **[16:9]** - For a wide-screen TV: display ratio 16:9.

### [Progressive]

If a progressive scan TV is connected to this product, turn on the progressive scan mode.

- **[On]** - Turn on progressive scan.
- **[Off]** - Turn off progressive scan mode.

### Note

- For more detailed description, see "Get started" > "Turn on progressive scan".

### [Picture Setting]

Select a predefined set of picture color settings or customize the personal setting.

- **[Standard]** - Original color setting.
- **[Bright]** - Vibrant color setting.
- **[Soft]** - Warm color setting.
- **[Personal]** - Customize the color setting. Set the level of brightness, contrast, tint and color saturation, then press **OK**.

### [My Wallpaper]

Select a picture as the wallpaper:

- **[Default picture]** - The default wallpaper preset as the Philips logo.
- **[Saved picture]** - A captured video image or JPEG photo.
- **[Current picture]** - Capture a video image or JPEG photo and save it on the product.

1. Play a video or photo slideshow.
2. Select a video image or photo: press **►||** to pause, and then press **SETUP**.
3. Navigate to the option (**[Video Setup]** > **[My Wallpaper]** > **[Current picture]**).
4. Press **OK** to confirm.
  - ↳ One video image or JPEG photo is saved as wallpaper.
  - ↳ A newly saved image or photo replaces the earlier one.

### [Component Video]









Select the video output that matches the video connection between this product and the TV.

- **[Interlaced]** - Component video (Y Pb Pr) connection.
- **[RGB]** - Scart (TV OUT) connection.

## Preferences

### Note

- Stop disc play before you can access to **[Preferences]**.

Preferences	
	Audio
	Subtitle
	Disc Menu
	Parental Control
	PBC
	Mp3/Jpeg Nav
	Password
	DivX Subtitle

- 1 Press **SETUP**.  
↳ **[General Setup]** menu is displayed.
- 2 Press **▼** to select **[Preferences]**, and then press **►**.
- 3 Select an option, and then press **OK**.
- 4 Select a setting, and then press **OK**.
  - To return to the previous menu, press **◀**.
  - To exit the menu, press **SETUP**.

#### [Audio]

Select an audio language for disc play.

#### [Subtitle]

Select a subtitle language for disc play.

#### [Disc Menu]

Select a disc menu language.

#### Note

- If the language you have set is not available on the disc, the disc uses its own default language.
- For some DVDs, the subtitle/audio language can only change from the disc menu.
- To select the languages that are not listed in the menu, select **[Others]**. Then check the Language Code list at the back of this user manual and enter the respective language code.

#### [Parental Control]

Restrict access to discs that are unsuitable for children. These types of discs must be recorded with ratings.

1. Press **OK**.
2. Select a rating level, then press **OK**.
3. Press the **numeric buttons** to enter the password.

#### Note

- Rated DVDs above the level you set in **[Parental Control]** require a password to be played.
- The ratings are country-dependent. To allow all discs to play, select **'8'**.
- Some discs have ratings printed on them but are not recorded with ratings. This function has no effect on such discs.

#### [PBC]

Turn on or off the content menu of VCDs/SVCDs with PBC (playback control) feature.

- **[On]** - Display the index menu when you load a disc for play.
- **[Off]** - Skip the menu and start play from the first track.

#### [Mp3/Jpeg Nav]

Select to display the folders or display all the files.

- **[View Files]** - Display all the files.
- **[View Folders]** - Display the folders of MP3/WMA files.

#### [Password]

Set or change the password for locked discs and play restricted DVDs.

Preferences Change Password	
Old Password	<input type="text"/>
New Password	<input type="text"/>
Confirm PWD	<input type="text"/>
<input type="button" value="OK"/>	

1. Press the **Numeric buttons** to enter '136900' or the last set password at **[Old Password]** field.
2. Enter the new password at **[New Password]** field.
3. Enter the new password again at **[Confirm PWD]** field.
4. Press **OK** to exit the menu.

#### Note

- If you forget the password, enter '136900' before you set a new password.

#### [DivX Subtitle]

Select a character set that supports the DivX subtitle.

- **[Standard]** - English, Irish, Danish, Estonian, Finnish, French, German, Italian, Portuguese,



Luxembourgish, Norwegian (Bokmål and Nynorsk), Spanish, Swedish, Turkish

- **[Central Europe]** - Polish, Czech, Slovak, Albanian, Hungarian, Slovene, Croatian, Serbian (Latin script), Romanian
- **[Cyrillic]** - Belarusian, Bulgarian, Ukrainian, Macedonian, Russian, Serbian
- **[Greek]** - Greek

#### Note

- Ensure that the subtitle file has the exact same file name as the movie file. If for example the file name of the movie is 'Movie.avi', then you need to name the text file 'Movie.sub' or 'Movie.srt'.

#### [Version Info]

Display the software version of this product.

#### Note

- This information is required when you want to find out if a newest software version is available at the Philips website that you may download and install on this product.

#### [Default]

Reset all the settings of this product to factory default, except for **[Disc Lock]**, **[Parental Control]** and **[Password]** settings.

## 8 Additional information

### Update software

For software updates, check the current software version of this product to compare with the latest software (if available) at the Philips website.

#### Caution

- Power supply must not be interrupted during software upgrade.

- 1 Press **SETUP**.
- 2 Select **[Preferences]** > **[Version Info]**, and then press **OK**.
- 3 Write down the file name, and then press **SETUP** to exit the menu.
- 4 Visit [www.philips.com/support](http://www.philips.com/support) to check for the latest software version, using the file name for this product.
- 5 Refer to the upgrade instructions on the website for more information

#### Note

- Disconnect the power cord for a few seconds and connect again to turn on the product.

### Care

#### Caution

- Never use solvents such as benzene, thinner, cleaners available commercially, or anti-static sprays intended for discs.

#### Clean discs

Wipe the disc with a micro fibre cleaning cloth from the centre to the edge in a straight line movement.

### Specifications

#### Note

- Specification and design are subject to change without notice

#### USB

- Compatibility: Hi-Speed USB (2.0)
- Class support: UMS (USB Mass Storage Class)

#### Video

- Signal system: PAL / NTSC
- Composite video output: 1 Vpp ~ 75 ohm
- Component video output: 0.7 Vpp ~ 75 ohm
- Scart: Euroconnector

#### Audio

- Analog stereo output
- Signal to noise ratio (1 kHz): > 100 dB (A-weighted)
- Dynamic Range (1 kHz): > 90 dB (A-weighted)
- Crosstalk (1 kHz): > 100 dB
- Distortion/noise: (1 kHz): > 85 dB
- MPEG MP3: MPEG Audio L3
- Digital output
  - Coaxial

#### Main unit

- Dimensions (w x h x d): 360 x 39 x 209 (mm)
- Net Weight: approximately 1.43 kg

#### Power

- Power supply rating: 230V, 50Hz
- Power consumption: < 8 W
- Power consumption in standby mode: < 0.3 W

#### Accessories supplied

- Remote control and batteries
- User Manual

### Laser specification

- Type: Semiconductor laser InGaAIP (DVD), AlGaAs (CD)
- Wave length: 656 nm (DVD), 790 nm (CD)
- Output Power: 7.0 mW (DVD), 10.0 mW (VCD/CD)
- Beam divergence: 60 degrees

## 9 Troubleshooting



### Warning

- Risk of electric shock. Never remove the casing of the product.

To keep the warranty valid, never try to repair the product yourself.

If you have problems using this product, check the following points before you request service. If you still have a problem, register your product and get support at [www.philips.com/welcome](http://www.philips.com/welcome).

If you contact Philips, you will be asked for the model and serial number of your product. The model number and serial number are on the back of your product. Write the numbers here:

Model No. \_\_\_\_\_

Serial No. \_\_\_\_\_

### Main unit

#### The buttons on this unit do not work.

- Disconnect this product from the power outlet for a few minutes, then connect again.

#### No reaction to the remote control.

- Connect this product to the power outlet.
- Point the remote control at the IR sensor located on the front panel of this product.
- Insert the batteries correctly.
- Insert new batteries in the remote control.

### Picture

#### No picture.

- See the TV's user manual on how to select the correct input on the TV. Change the TV channel until you see the Philips screen.
- If you have turned on the progressive scan setting or change the TV system setting, switch back to default mode: 1) Press **▲** to open the disc compartment. 2) Press the **Numeric button '1'** (for progressive scan) or the **Numeric button '3'** (for TV system).

### Sound

#### No audio output from the TV.

- Ensure that the audio cables are connected to the audio input of the TV.
- Assign the audio input of the TV to the corresponding video input. See the TV user manual for details.

#### No audio output from the loudspeakers of the audio device (stereo system/amplifier/receiver).

- Ensure that the audio cables are connected to the audio input of the audio device.
- Turn on the audio device to its correct audio input source.

#### No sound during DivX video playback

- The audio codec may not be supported by this product.

### Play

#### The disc cannot be played.

- The disc is badly scratched, deformed, or dirty. Replace or clean the disc.
- Use the correct disc format or file format.

#### DivX video files cannot be played.

- Ensure that the DivX video file is complete.
- Ensure that the file name extension is correct.
- Due to Digital Rights issue, the DRM-protected video files cannot be played through an analog video connection (e.g. composite, component and scart). Transfer the video content onto the Disc Media and play these files.

#### The aspect ratio of the screen is not aligned with the TV display setting.

- The aspect ratio is fixed on the disc.

#### DivX subtitles are not displayed correctly.

- Ensure that the subtitle file name is the same as the movie file name.
- Select the correct character set.
  - Press **SETUP**.
  - Select **[Preferences] > [DivX Subtitle]** in the menu.
  - Select the character set that supports the subtitle.

