

Register your product and get support at  
[www.philips.com/welcome](http://www.philips.com/welcome)

FWM654



---

EN User manual

---

**PHILIPS**

# Content

<b>1 Important</b>	<b>4</b>	<b>7 Listen to radio</b>	<b>17</b>
Safety	4	Tune to a radio station	17
Notice	5	Program radio stations automatically	17
		Program radio stations manually	17
		Select a preset radio station	17
<b>2 Your Mini Hi-Fi System</b>	<b>6</b>	<b>8 Other features</b>	<b>18</b>
Introduction	6	Set the alarm timer	18
What's in the box	6	Set the sleep timer	18
Overview of the main unit	7	Listen to an external device	18
Overview of the remote control	9	Karaoke	19
<b>3 Get started</b>	<b>11</b>	<b>9 Product information</b>	<b>20</b>
Connect FM antenna	11	Specifications	20
Connect AM antenna	11	USB playability information	21
Connect speakers	11	Supported MP3 disc formats	21
Connect power	12	Maintenance	21
Prepare the remote control	12		
Auto install radio stations	13	<b>10 Troubleshooting</b>	<b>22</b>
Set clock	13		
Turn on	13		
<b>4 Play</b>	<b>14</b>		
Play disc	14		
Play from USB	14		
Play from an external device	14		
<b>5 Play options</b>	<b>15</b>		
Repeat and random play	15		
Program tracks	15		
Display play information	15		
<b>6 Adjust volume level and sound effect</b>	<b>16</b>		
Adjust volume level	16		
Mute sound	16		
Boost sound power	16		
Select a preset sound effect	16		
Enhance bass	16		
Incredible surround	16		
Customize sound for room acoustics	16		

# 1 Important

---

## Safety

- ① Read these instructions.
- ② Keep these instructions.
- ③ Heed all warnings.
- ④ Follow all instructions.
- ⑤ Do not use this apparatus near water.
- ⑥ Clean only with dry cloth.
- ⑦ Do not block any ventilation openings. Install in accordance with the manufacturer's instructions.
- ⑧ Do not install near any heat sources such as radiators, heat registers, stoves, or other apparatus (including amplifiers) that produce heat.
- ⑨ Protect the power cord from being walked on or pinched, particularly at plugs, convenience receptacles, and the point where they exit from the apparatus.
- ⑩ Only use attachments/accessories specified by the manufacturer.
- ⑪ Use only with the cart, stand, tripod, bracket, or table specified by the manufacturer or sold with the apparatus. When a cart is used, use caution when moving the cart/apparatus combination to avoid injury from tip-over.
- ⑫ Unplug this apparatus during lightning storms or when unused for long periods of time.
- ⑬ Refer all servicing to qualified service personnel. Servicing is required when the apparatus has been damaged in any way, such as power-supply cord or plug is damaged, liquid has been spilled or objects have fallen into the apparatus, the apparatus has been exposed to rain or moisture, does not operate normally, or has been dropped.
- ⑭ Battery usage CAUTION – To prevent battery leakage which may result in bodily injury, property damage, or damage to the unit:
  - Install all batteries correctly, + and - as marked on the unit.
  - Do not mix batteries (old and new or carbon and alkaline, etc.).
  - Remove batteries when the unit is not used for a long time.
- ⑮ Apparatus shall not be exposed to dripping or splashing.
- ⑯ Do not place any sources of danger on the apparatus (e.g. liquid filled objects, lighted candles).
- ⑰ This product may contain lead and mercury. Disposal of these materials may be regulated due to environmental considerations. For disposal or recycling information, please contact your local authorities or the Electronic Industries Alliance: [www.eiae.org](http://www.eiae.org).
- ⑱ Where the MAINS plug or an appliance coupler is used as the disconnect device, the disconnect device shall remain readily operable.



## Warning

- Never remove the casing of this apparatus.
- Never lubricate any part of this apparatus.
- Never place this apparatus on other electrical equipment.
- Keep this apparatus away from direct sunlight, naked flames or heat.
- Never look into the laser beam inside this apparatus.
- Ensure that you always have easy access to the power cord, plug or adaptor to disconnect this apparatus from the power.

## Caution

- Use of controls or adjustments or performance of procedures other than herein may result in hazardous radiation exposure or other unsafe operation.

packaging materials, exhausted batteries and old equipment.



Windows Media and the Windows logo are trademarks, or registered trademarks of Microsoft Corporation in the United States and/or other countries.

**This apparatus includes this label:**

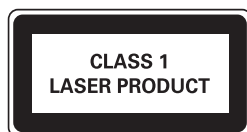

## Notice

Any changes or modifications made to this device that are not expressly approved by Philips Consumer Lifestyle may void the user's authority to operate the equipment.



The making of unauthorized copies of copy-protected material, including computer programs, files, broadcasts and sound recordings, may be an infringement of copyrights and constitute a criminal offence. This equipment should not be used for such purposes.

### Environmental information

All unnecessary packaging has been omitted. We have tried to make the packaging easy to separate into three materials: cardboard (box), polystyrene foam (buffer) and polyethylene (bags, protective foam sheet.)

Your system consists of materials which can be recycled and reused if disassembled by a specialized company. Please observe the local regulations regarding the disposal of

## 2 Your Mini Hi-Fi System

Congratulations on your purchase, and welcome to Philips! To fully benefit from the support that Philips offers, register your product at [www.Philips.com/welcome](http://www.Philips.com/welcome).

### Introduction

With this unit, you can enjoy audio from discs, USB devices, external devices, or radio stations. For your convenience, you can load up to 3 discs at once.

To enrich sound, this unit offers you these sound effects:

- MAX sound for instant power boost
- Digital Sound Control (DSC)
- Dynamic Bass Boost (DBB)
- Incredible surround (IS)
- Virtual Ambience-based Control (VAC)

The unit supports the following media formats:



---

## What's in the box



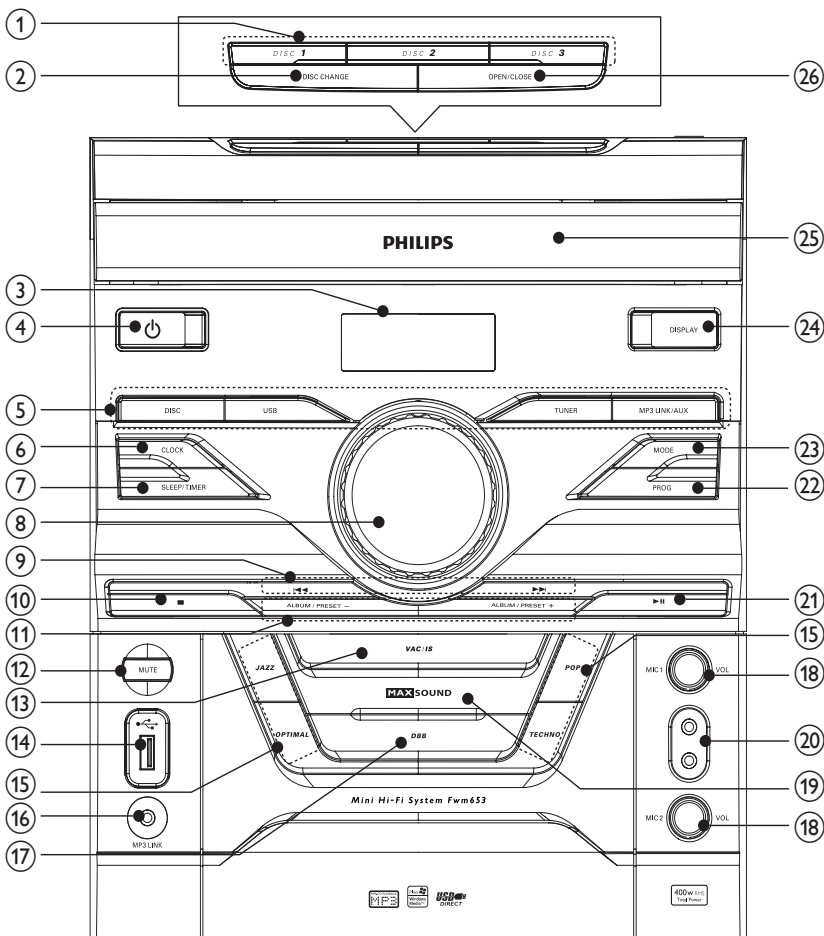

Check and identify the contents of your package:

- Main unit x 1
- AC power cable x 1
- Loudspeaker box x 2
- Subwoofer x 1
- Remote control with 2 AAA batteries
- FM wire antenna x 1
- AM loop antenna x 1
- MP3 link cable x 1
- Quick start guide
- User manual

# Overview of the main unit



- |   |   |
|---|---|
| <p>① DISC 1/2/3</p> <ul style="list-style-type: none"> <li>• Select a disc.</li> </ul> <p>② DISC CHANGE</p> <ul style="list-style-type: none"> <li>• Change a disc.</li> </ul> <p>③ Display panel</p> <ul style="list-style-type: none"> <li>• Show current status.</li> </ul> <p>④ </p> <ul style="list-style-type: none"> <li>• Turn on the unit or switch to standby mode.</li> </ul> | <p>⑤ Source selection keys</p> <ul style="list-style-type: none"> <li>• Select a source.</li> </ul> <p>⑥ CLOCK</p> <ul style="list-style-type: none"> <li>• Set the clock.</li> </ul> <p>⑦ SLEEP/TIMER</p> <ul style="list-style-type: none"> <li>• Set the sleep timer.</li> <li>• Set the alarm timer.</li> <li>• Turn on or off sleep/alarm timer.</li> </ul> <p>⑧ VOLUME</p> <ul style="list-style-type: none"> <li>• Adjust volume.</li> </ul> |
|---|---|

- ⑨ 
  - Skip to the previous/next track.
  - Search within a track/ disc/USB.
  - Tune to a radio station.
  - Adjust time.
- ⑩ 
  - Stop play or erase a program.
- ⑪ **ALBUM/PRESET+/-**
  - Skip to the previous/next album.
  - Select a preset radio station.
  - Adjust time.
  - Select 12 hour or 24 hour format.
- ⑫ **MUTE**
  - Mute volume.
- ⑬ **VAS/IS**
  - Select an ambience-based equaliser setting.
  - Turn on or off incredible surround.
- ⑭ 
  - Jack for a USB mass storage device.
- ⑮ **DSC**
  - Select a preset sound equalizer setting.
- ⑯ **MP3 LINK**
  - Audio input jack (3.5mm ) for an external audio device.
- ⑰ **DBB**
  - Turn on or off dynamic bass enhancement.
- ⑱ **MIC VOL**
  - Adjust microphone volume.
- ⑲ **MAX SOUND**
  - Turn on or off instant power boost for sound.
- ⑳ **Microphone port**
  - Jack for a microphone.
- ㉑ 
  - Start or pause play.
- ㉒ **PROG**
  - Program tracks.
  - Program radio stations.
- ㉓ **MODE**
  - Select repeat play or random play.
- ㉔ **DISPLAY**
  - Select display information.
- ㉕ **Disc compartment door**
- ㉖ **OPEN/CLOSE**
  - Open or close the disc compartment.

## Overview of the remote control

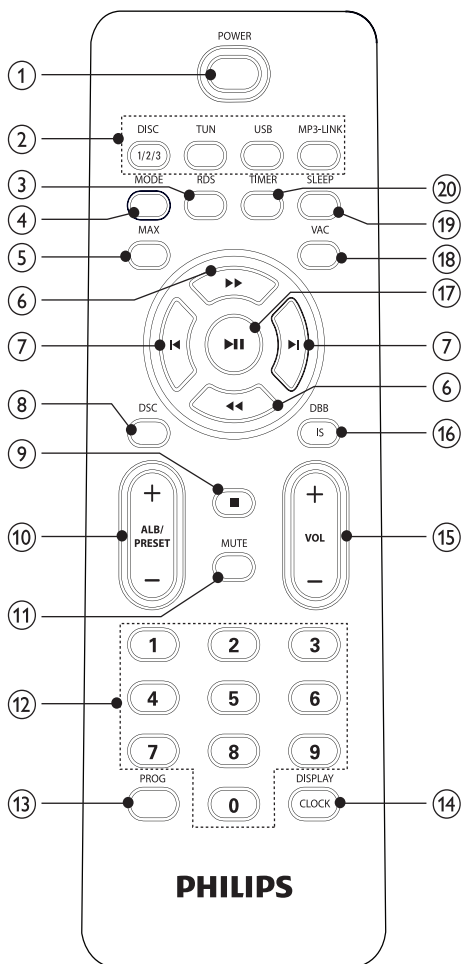

### ① POWER

- Turn on the unit \_\_\_ or switch to standby mode.

### ② Source selection keys

- Select a source.

### ③ RDS

### ④ MODE

- Select repeat play or random play.

### ⑤ MAX

- Turn on or off instant power boost for sound.

### ⑥ ◀▶▶

- Search within a track/ disc/USB.
- Tune to a radio station.

### ⑦ ◀▶

- Skip to the previous/next track.
- Adjust time.

### ⑧ DSC

- Select a preset sound equalizer setting.

### ⑨ ■

- Stop play or erase a program.

### ⑩ ALB/PRESET+/-

- Skip to the previous/next album.
- Tune to a radio station.
- Adjust time.

### ⑪ MUTE

- Mute volume.

### ⑫ Numeric keypad

- Select a track from a disc directly.

### ⑬ PROG

- Program tracks.
- Program radio stations.

### ⑭ DISPLAY/CLOCK

- Select display information.
- Set the clock.

### ⑮ VOL +/-

- Adjust volume.

### ⑯ DDB/IS

- Turn on or off dynamic bass enhancement.
- Turn on or off incredible surround.

### ⑰ ▶||

- Start or pause play.



- ⑱ **VAC**
  - Select an ambience-based equaliser setting.
- ⑲ **SLEEP**
  - Set the sleep timer.
- ⑳ **TIMER**
  - Set the alarm timer.

## 3 Get started

### ! Caution

- Use of controls or adjustments or performance of procedures other than herein may result in hazardous radiation exposure or other unsafe operation.

Always follow the instructions in this chapter in sequence.

If you contact Philips, you will be asked for the model and serial number of this apparatus. The model number and serial number are on the back of the apparatus. Write the numbers here:

Model No. \_\_\_\_\_

Serial No. \_\_\_\_\_

### Connect FM antenna

- 1 Connect the supplied FM antenna to the FM jack on the back of the main unit.

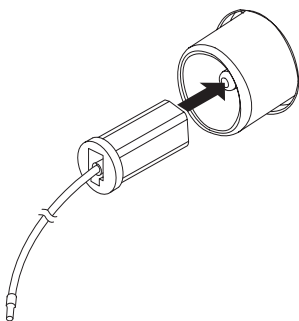

### Connect AM antenna

- 1 Assemble the AM loop antenna.

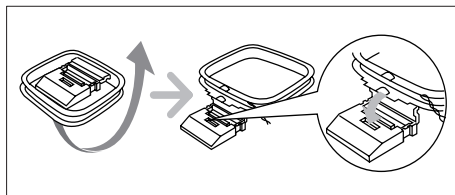

- 2 Connect the AM loop antenna to the AM jack on the back of the main unit.

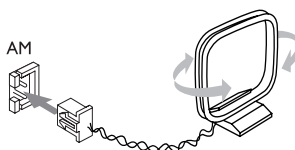

### Connect speakers

#### ☰ Note

- For optimal sound, use the supplied speakers only.
- Connect only speakers with impedance that is the same or higher than the supplied speakers. Refer to the Specifications section of this manual.

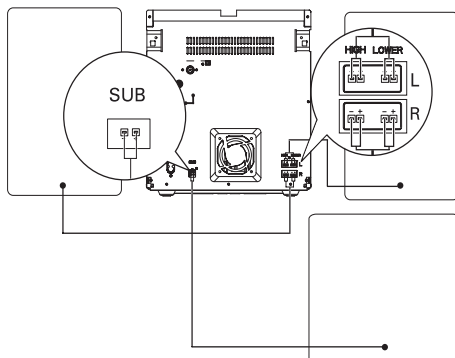

To connect speakers to the main unit:

- 1 Insert the connector of the right speaker wire to "R", and the connector of the left speaker wire to "L".

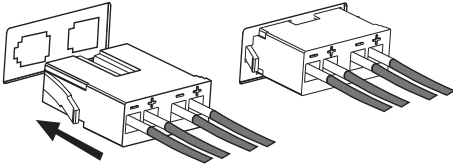

- 2 Insert the connector of the subwoofer wire to "SUB" socket.

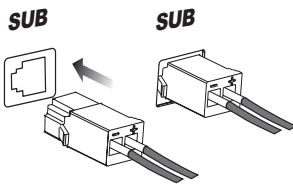

## Connect power

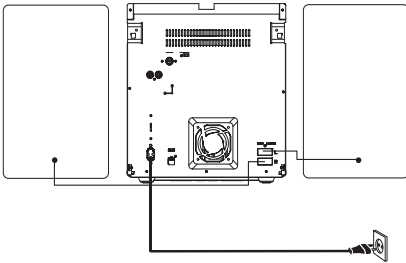

### ! Caution

- Risk of product damage! Ensure that the power supply voltage corresponds to the voltage set on the voltage selector on the back of the unit.
- Before connecting the AC power cord, ensure you have completed all other connections.

### ≡ Note

- The type plate is located on the back of the main unit.

- 1 Connect the AC power cable to:
  - the main unit.
  - the wall socket.

## Prepare the remote control

### ≡ Note

- Risk of explosion! Keep batteries away from heat, sunshine or fire. Never discard batteries in fire.

To replace the remote control battery:

- 1 Open the battery compartment.
- 2 Insert two AAA batteries with correct polarity (+/-) as indicated.
- 3 Close the battery compartment.

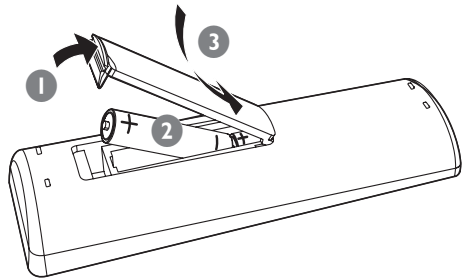

### ≡ Note

- If you are not going to use the remote control for a long time, remove the batteries.
- Do not use old and new or different types of batteries in combination.
- Batteries contain chemical substances, so they should be disposed of properly.

## Auto install radio stations

When you connect power and no radio stations are stored, the unit automatically begins to store radio stations.

- 1 Connect the unit to the power supply.
  - ↳ [AUTO INSTALL - PRESS PLAY] (auto install - press the PLAY button) is displayed.
- 2 Press **▶||** on the main unit to start installation.
  - ↳ [AUTO] (auto) is displayed.
  - ↳ The unit automatically stores radio stations with sufficient signal strength.
  - ↳ When all the available radio stations are stored, the first preset radio station is broadcast automatically.

## Set clock

- 1 In the standby mode, press **DISPLAY/CLOCK** to activate the clock setting mode.
  - ↳ The 12 hour or 24 hour format is displayed.
- 2 Press **ALB/PRESET+/-** repeatedly to select 12 hour or 24 hour format.
- 3 Press **DISPLAY/CLOCK** to confirm.
  - ↳ The clock digits are displayed and begin to blink.
- 4 Press **ALB/PRESET+/-** to set the hour.
- 5 Press **◀/▶** to set the minute.
- 6 Press **DISPLAY/CLOCK** to confirm.



### Tip

- To view the clock during play, press **DISPLAY/CLOCK**.

## Turn on

- 1 Press **POWER**.
  - ↳ The unit switches to the last selected source.

## Switch to standby

- 1 Press **⏻** to switch the unit to standby mode.
  - ↳ The backlight on the display panel is dimmed.
  - ↳ The clock (if set) appears on the display panel.

## 4 Play

### Play disc

- 1 Press **CD 1/2/3** to select the disc source.
- 2 Press **OPEN/CLOSE** on the main unit to open the disc compartment.
- 3 Load up to two discs on the disc trays, with the printed side facing up.
  - To load the third disc, press **DISC CHANGE** on the main unit to rotate to the disc tray.

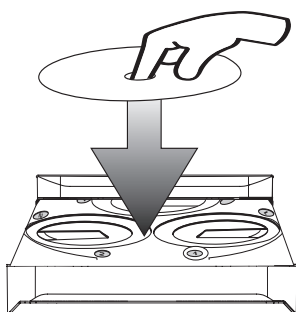

- 4 Press **OPEN/CLOSE** on the main unit to close the disc compartment.
  - ↳ Play starts automatically.
  - To select a disc, press **DISC 1/2/3**.
  - To pause/resume play, press **▶||**.
  - To stop play, press **■**.
  - To select another track, press **◀▶** or press a numeric button.
  - To select an album, press **ALB/PRESET+/-**.
  - To search within a track, press and hold **◀▶**, then release to resume normal play.

### Play from USB

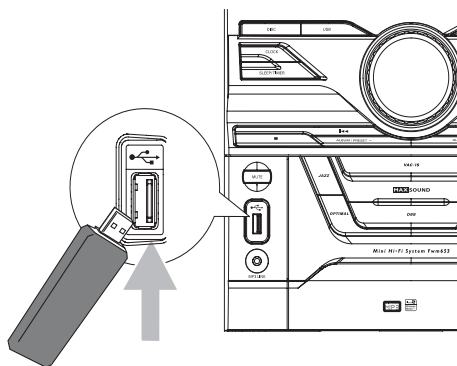

#### Note

- Ensure that the USB device contains playable audio contents for supported formats. (see 'USB playability information' on page 21)

- 1 Insert the USB plug of the device into the **USB** socket.
- 2 Press **USB** to select the USB source.
- 3 Press **ALB/PRESET+/-** to select a folder.
- 4 Press **◀▶** to select an audio file.
- 5 Press **▶||** to start play.
  - To pause/resume play, press **▶||**.
  - To stop play, press **■**.
  - To search within an audio file, press and hold **◀▶**, then release to resume normal play.





### Play from an external device

You can also listen to an external audio device through this unit.

- 1 Press **MP3-LINK** to select the MP3 link source.
- 2 Connect the supplied MP3 link cable to:
  - the **MP3 LINK** jack (3.5mm) on the unit.
  - the headphone jack on an external device.
- 3 Start to play the device (see the device user manual).

## 5 Play options

### Repeat and random play

- 1 Press **MODE** repeatedly to select:
  - : the current track is played repeatedly.
  - : all tracks are played repeatedly.
  - : all tracks are played randomly and repeatedly.
  - : all tracks are played randomly.
- 2 To return to normal play, press **MODE** repeatedly until play mode is no longer displayed.



#### Tip

- Shuffle play cannot be selected when you play programmed tracks.

### Display play information

- 1 During play, press **DISPLAY/CLOCK** repeatedly to select different play information.

### Program tracks

You can program a maximum of 40 tracks.

- 1 At CD/USB mode, in the stop position, press **PROG** to activate the program mode.
  - ↳ [PROG] (program) blinks on the display.
- 2 For MP3/WMA tracks, press **ALB/ PRESET+/-** to select an album.
- 3 Press **◀▶** to select a track number, then press **PROG** to confirm.
- 4 Repeat steps 2 to 3 to select and store all tracks to program.
- 5 Press **▶||** to play the programmed tracks.
  - ↳ During play, [PROG] (program) is displayed.
    - To erase the program, in the stop position, press **■**.

# 6 Adjust volume level and sound effect

## Note

- MAX sound and DSC (Digital Sound Control) cannot be activated at the same time.

---

## Adjust volume level

- 1 During play, press **VOL +/-** to increase/decrease the volume level.

---

## Mute sound

- 1 During play, press **MUTE** to mute/unmute sound.

---

## Boost sound power

MAX SOUND gives an instant boost to the sound power .

- 1 Press **MAX** to turn on or off the sound power boost.
  - ↳ If MAX sound is activated, MAX is displayed.

---

## Select a preset sound effect

The DSC (Digital Sound Control) enables you to enjoy special sound effects.

- 1 During play, press **DSC** repeatedly to select:
  - [JAZZ] (jazz)
  - [POP] (pop)

- [TECHNO] (techno)
- [OPTIMAL] (optimal)

---

## Enhance bass

The best DBB (Dynamic Bass Enhancement) setting is generated automatically for each DSC selection. You can manually select the DBB setting that best suits your listening environment.

- 1 During play, press **DBB/IS** repeatedly to select:
  - DBB 1
  - DBB 2
  - DBB 3
  - DBB off
  - ↳ If DBB is activated, **DBB** is displayed.

---

## Incredible surround

You can enhance audio with a virtual surround sound effect.

- 1 Press and hold **DBB/IS** to turn on or off the incredible surround.
  - ↳ If the incredible surround is activated, [INC SURR] (incredible surround) is displayed.

---

## Customize sound for room acoustics

- 1 During play, press **VAC** repeatedly to select a type of listening environment:
  - [HALL] (hall)
  - [CINEMA] (cinema)
  - [CONCERT] (concert)

# 7 Listen to radio

## Tune to a radio station

- 1 Press **TUN** repeatedly to select FM or AM.
- 2 Press and hold **◀▶** for more than 2 seconds.
  - ↳ [SEARCH] (search) is displayed.
  - ↳ The radio tunes to a station with strong reception automatically.
- 3 Repeat step 2 to tune to more stations.
  - To tune to a weak station, press **◀▶** repeatedly until you find optimal reception.

## Program radio stations automatically

You can program a maximum of 40 preset radio stations.

- 1 In the tuner mode, press and hold **PROG** for more than 2 seconds to activate automatic program mode.
  - ↳ [AUTO] (auto) is displayed.
  - ↳ All available stations are programmed in the order of waveband reception strength.
  - ↳ The first programmed radio station is broadcast automatically.

## Program radio stations manually

You can program a maximum of 40 preset radio stations.

- 1 Tune to a radio station.
- 2 Press **PROG** to activate program mode.
  - ↳ [PROG] (program) blinks on the display.
- 3 Press **ALB/PRESET+/-** to allocate a number to this radio station, then press **PROG** to confirm.
  - ↳ The preset number and the frequency of the preset station are displayed.
- 4 Repeat the above steps to program other stations.

### Tip

- To overwrite a programmed station, store another station in its place.

## Select a preset radio station

- 1 In tuner mode, press **ALB/PRESET+/-** to select a preset number.

### Tip

- Position the antenna as far as possible from TV, VCR or other radiation source.
- For optimal reception, fully extend and adjust the position of the antenna.





# 8 Other features

## Set the alarm timer

This unit can be used as an alarm clock. The disc, radio or USB is activated to play at a preset time.

- 1 Ensure that you have set the clock correctly. (see 'Set clock' on page 13)
- 2 Press **POWER** to switch to standby mode.
- 3 Press and hold **TIMER** for more than 2 seconds.  
↳ A prompt to select the source is displayed.
- 4 Press **DISC 1/2/3**, or **TUN** or **USB** to select a source.
- 5 Press **TIMER** to confirm.  
↳ The clock digits are displayed and begin to blink.
- 6 Press **ALB/PRESET+/-** to set the hour.
- 7 Press **◀▶** to set the minute.
- 8 Press **TIMER** to confirm.  
↳ The timer is set and activated.

### To deactivate or re-activate an alarm timer

- 1 When the unit is turned on, press **TIMER** repeatedly.  
↳ If the timer is activated,  is displayed.  
↳ If the timer is deactivated,  disappears.

#### Note

- In MP3 link mode, the alarm timer cannot be set.

#### Tip

- If disc/USB source is selected and the audio cannot be played, tuner is activated automatically.

## Set the sleep timer

This unit can switch to standby automatically after a set period of time.

- 1 When the unit is turned on, press **SLEEP** repeatedly to select a set period of time (in minutes).  
↳ When sleep timer is activated, **zZ** is displayed.
- 2 Press **SLEEP** repeatedly until [OFF] (off) is displayed.  
↳ When sleep timer is deactivated, **zZ** disappears on the display.

## Listen to an external device

You can listen to an external audio device through this unit.

### For audio players with headphone sockets

- 1 Press **MP3 LINK/AUX** repeatedly to select the MP3 link source.
- 2 Connect the supplied MP3 link cable to:
  - the **MP3 LINK** jack (3.5mm) on the unit.
  - the headphone jack on an external device.
- 3 Start to play the device (refer to the device's user manual).

### For audio players with red/white audio output sockets

- 1 Press **MP3 LINK/AUX** repeatedly to select the AUX source.
- 2 Connect the audio cables (white/red jacks, not supplied) to:
  - the **AUX IN** jacks on the back of the unit.
  - the **AUDIO OUT** jacks on an external device.
- 3 Start to play the device (refer to the device's user manual).

---

## Karaoke

You can connect a microphone and sing along with a music source.

- 1** Turn **MIC VOL** to the minimum level.
- 2** Connect a microphone to the microphone port on the unit.
- 3** Press **CD 1/2/3**, or **TUNER**, or **USB**, or **MP3 LINK/AUX** to select the source, and start play.
- 4** Sing through the microphone.
  - To adjust the volume of the source, press **VOL +/-**.
  - To adjust the volume of the microphone, turn **MIC VOL**.

# 9 Product information



## Note

- Product information is subject to change without prior notice.

## Specifications

### Amplifier

Total output power	400W RMS
Frequency response	60 - 16kHz
Signal-to-noise ratio	>67dB A (IEC)
Aux input	2000mV/2500mV

### Disc

Laser type	Semiconductor
Disc diameter	12cm/8cm
Support disc	CD-DA, CD-R, CD-RW, MP3-CD, WMA-CD
Audio DAC	24Bits / 44.1kHz
Total harmonic distortion	<1%
Frequency response	60Hz -16kHz (44.1kHz)
S/N ratio	>75dB

### Tuner

Tuning range	FM: 87.5 - 108MHz; AM: 531 - 1602kHz (9KHz); 530 - 1700KHz (10KHz)
Tuning grid	100KHz (FM); 9KHz/10KHz (AM)
Number of presets	40 (FM + AM)
FM	75ohm wire
AM	loop antenna

### Speakers

Speaker Impedance	6ohm
Woofer	2 x 5.25"
Tweeter	2 x 1.75"
Dimensions (W x H x D)	210 x 310 x 292 mm
Weight	3.58kg each

### Subwoofer

Speaker impedance	6ohm
Speaker driver	8"
Dimensions (W x H x D)	260 x 310 x 426 mm
Weight	6.75kg

### General information

AC power	110 - 127/220 - 240V, 50/60Hz
Operation power consumption	130W
Standby power consumption	<15W
USB direct	Version 2.0/1.1
Dimensions Main Unit (W x H x D)	269 x 310 x 352 mm
Weight (without speakers)	6.09kg

## USB playability information

### Compatible USB devices:

- USB flash memory (USB 2.0 or USB 1.1)
- USB flash players (USB 2.0 or USB 1.1)
- memory cards (requires an additional card reader to work with this unit)

### Supported formats:

- USB or memory file format FAT12, FAT16, FAT32 (sector size: 512 bytes)
- MP3 bit rate (data rate): 32-320 Kbps and variable bit rate
- WMA v9 or earlier
- Directory nesting up to a maximum of 8 levels
- Number of albums/ folders: maximum 99
- Number of tracks/titles: maximum 999
- ID3 tag v2.0 or later
- File name in Unicode UTF8 (maximum length: 128 bytes)

### Unsupported formats:

- Empty albums: an empty album is an album that does not contain MP3/ WMA files, and is not be shown in the display.
- Unsupported file formats are skipped. For example, Word documents (.doc) or MP3 files with extension .dlf are ignored and not played.
- AAC, WAV, PCM audio files
- DRM protected WMA files (.wav, .m4a, .m4p, .mp4, .aac)
- WMA files in Lossless format

- Supported sampling frequencies: 32 kHz, 44.1kHz, 48 kHz
- Supported Bit-rates: 32-320 (kbps), variable bit rates
- ID3 tag v2.0 or later
- Directory nesting up to a maximum of 8 levels

## Maintenance

### Clean the cabinet

- Use a soft cloth slightly moistened with a mild detergent solution. Do not use a solution containing alcohol, spirits, ammonia or abrasives.

### Clean discs

- When a disc becomes dirty, clean it with a cleaning cloth. Wipe the disc from the centre out.



- Do not use solvents such as benzene, thinner, commercially available cleaners, or antistatic spray intended for analogue records.

### Clean the disc lens

- After prolonged use, dirt or dust may accumulate at the disc lens. To ensure good play quality, clean the disc lens with Philips CD lens cleaner or any commercially available cleaner. Follow the instructions supplied with cleaner.

## Supported MP3 disc formats

- ISO9660, Joliet
- Maximum title number: 999 (depending on file name length)
- Maximum album number: 99

# 10 Troubleshooting



## Warning

- Never remove the casing of this apparatus.

To keep the warranty valid, never try to repair the system yourself.

If you encounter problems when using this apparatus, check the following points before requesting service. If the problem remains unsolved, go to the Philips web site ([www.philips.com/welcome](http://www.philips.com/welcome)). When you contact Philips, ensure that the apparatus is nearby and the model number and serial number are available.

### No power

- Ensure that the AC power plug of the unit is connected properly.
- Ensure that there is power at the AC outlet.
- To save power, the unit switches to standby automatically 15 minutes after a play reaches the end and no control is operated.

### No sound or poor sound

- Adjust the volume.
- Check that the speakers are connected correctly.
- Check if the stripped speaker wires are clamped.

### Left and right sound outputs reversed

- Check the speaker connections and location.

### No response from the unit

- Disconnect and reconnect the AC power plug, then turn on the unit again.

### Remote control does not work

- Before you press any function button, first select the correct source with the remote control instead of the main unit.
- Reduce the distance between the remote control and the unit.
- Insert the batteries with their polarities (+/- signs) aligned as indicated.

- Replace the batteries.
- Aim the remote control directly at the sensor on the front of the main unit.

### No disc detected

- Insert a disc.
- Check if the disc is inserted upside down.
- Wait until the moisture condensation at the lens has cleared.
- Replace or clean the disc.
- Use a finalized CD or correct format disc.

### Cannot display some files in USB device

- The number of folders or files in the USB device has exceeded a certain limit. This phenomenon is not a malfunction.
- The formats of these files are not supported.

### USB device not supported

- The USB device is incompatible with the unit. Try another one.

### Poor radio reception

- Increase the distance between the unit and your TV or VCR.
- If the signal is too weak, adjust the antenna or connect an external antenna for better reception.

### Clock/timer setting erased

- Power has been interrupted or the power cord has been disconnected.
- Reset the clock/timer.

### Timer does not work

- Set the clock correctly.
- Switch on the timer.

