

PHILIPS

Soundbar

8000 Series

TAB8967



User manual

Register your product and get support at:
www.philips.com/support

Contents

1 Important	4
Safety	4
Care for your product	5
Care of the environment	5
Help and support	6

2 Your Soundbar	7
What's in the Box	7
Main unit	8
Main unit Connectors	9
Surround R/L	9
Wireless subwoofer	10
Remote control	10
Prepare the Remote Control	11
Placement	13
Wall mount	13

3 Connect	15
Dolby Atmos®	15
Connect to HDMI Socket	15
Connect to Optical Socket	16
Connect to AUX Socket	16
Connect to Power	17
Pair up with the subwoofer	17
Pair up with Surround R/L	18
Connect to Wi-Fi (Wireless Operation)	19

4 Use your Soundbar	22
Turn ON and OFF	22
Auto Standby	22
Select Modes	22
Adjust the Volume	22
Dolby sound mode	22
Factory Reset	23
Setup Menu	23
Bluetooth® Operation	26
AUX / OPTICAL / HDMI ARC Operation	27
USB Operation	27
Upgrade Firmware	28

5 Product specifications	29
---------------------------------	----

6 Terms of Use and Privacy Statement	31
---------------------------------------------	----

7 Troubleshooting	32
--------------------------	----

8 Trademarks	34
---------------------	----

1 Important

Read and understand all instructions before you use your product. If damage is caused by failure to follow instructions, the warranty does not apply.

Safety

Risk of electric shock or fire!

- Before you make or change any connections, make sure that all devices are disconnected from the power outlet.
- Never expose the product and accessories to rain or water. Never place liquid containers, such as vases, near the product. If liquids are spilled on or into the product, disconnect it from the power outlet immediately. Contact Consumer Care to have the product checked before use.
- Never place the product and accessories near naked flames or other heat sources, including direct sunlight.
- Never insert objects into the ventilation slots or other openings on the product.
- Where the mains plug or an appliance coupler is used as the disconnect device, the disconnect device shall remain readily operable.
- Battery (battery pack or batteries installed) shall not be exposed to excessive heat such as sunshine, fire or the like.
- Disconnect the product from the power outlet before lightning storms.
- When you disconnect the power cord, always pull the plug, never the cable.
- Use the product in tropical and/or moderate climates.

Risk of short circuit or fire!

- For identification and supply ratings, see the type plate at the back or bottom of the product.
- Before you connect the product to the power outlet, ensure that the power voltage matches the value printed on the back or bottom of the product. Never connect the product to the power outlet if the voltage is different.

Risk of injury or damage to this product!

- For wall mounting, this product must be securely attached to the wall in accordance with the installation instructions. Use only the supplied wall mount bracket (if available). Improper wall mounting may result in accident, injury or damage. If you have any query, contact Consumer Care in your country.
- Never place the product or any objects on power cords or on other electrical equipment.
- If the product is transported in temperatures below 5°C, unpack the product and wait until its temperature matches room temperature before connecting it to the power outlet.
- Parts of this product can be made of glass. Handle with care to avoid injury and damage.

Risk of overheating!

- Never install this product in a confined space. Always leave a space of at least four inches around the product for ventilation. Ensure curtains or other objects never cover the ventilation slots on the product.

Risk of contamination!

- Do not mix batteries (old and new or carbon and alkaline, etc.).
- CAUTION: Danger of explosion if batteries are incorrectly replaced. Replace only with the same or equivalent type.

- Remove batteries if they are exhausted or if the remote control is not to be used for a long time.
- Batteries contain chemical substances, they should be disposed of properly.

Risk of swallowing batteries!

- The product/remote control may contain a coin/button type battery, which can be swallowed. Keep the battery out of reach of children at all times! If swallowed, the battery can cause serious injury or death. Severe internal burns can occur within two hours of ingestion.
- If you suspect that a battery has been swallowed or placed inside any part of the body, seek immediate medical attention.
- When you change the batteries, always keep all new and used batteries out of reach of children. Ensure that the battery compartment is completely secure after you replace the battery.
- If the battery compartment cannot be completely secured, discontinue use of the product. Keep out of reach of children and contact the manufacturer.



This is CLASS II apparatus with double insulation, and no protective earth provided.

~

AC voltage



Use only the power supplies listed in the user manual.

Care for your product

Use only microfiber cloth to clean the product.

Care of the environment

Disposal of your old product and battery



Your product is designed and manufactured with high quality materials and components, which can be recycled and reused.

Removing the disposable batteries

To remove the disposable batteries, see battery installation section.

Help and support

For extensive online support, visit

www.philips.com/support to:

- download the user manual and the quick start guide
- watch video tutorials (available only for selected models)
- find answers to frequently answered questions (FAQs)
- email us a question
- chat with our support representative.

Follow the instructions on the website to select your language, and then enter your product model number.

Alternatively, you can contact Consumer Care in your country. Before you contact, note down the model number and serial number of your product. You can find this information on the back or bottom of your product.

2 Your Soundbar

Congratulations on your purchase, and welcome to Philips! To fully benefit from the support that Philips offers, register your Soundbar at www.philips.com/support.

What's in the Box

Check and identify the items in the package:

- Soundbar x 1
- Wireless Subwoofer x 1
- Surround R/L x 2
- Remote Control x 1
(Battery AAA x 2)
- Power Cord * x 2
- Adapter ** x 1
- RCA Cable x 1
- Wall Mount kit - Subwoofer x 1
(Wall Brackets x2, Screws x2, Dowels x2)
- Wall Mount kit - Surround R/L x 1
(Wall Brackets x2, Screws x2)
- Adaptor Accessories ** x 3
- Quick Start Guide / Warranty Card / Safety Sheet / Wall Mount Template x 1



* Power cord quantity and plug type vary by regions.
** Please refer to Quick Start Guide for Adapter Accessories and Adapter assembly instructions.

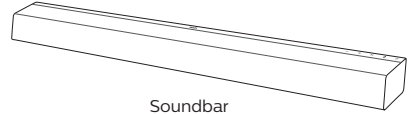

Soundbar

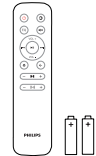

Remote Control and batteries

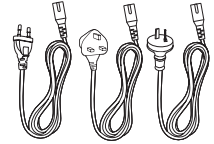

Power Cord * 2 X (Soundbar and Subwoofer)

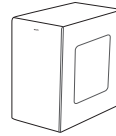

Wireless Subwoofer

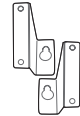

Soundbar Wall Bracket

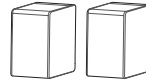

Surround R/L



Surround R/L Wall Bracket



RCA Cable (Surround R/L)

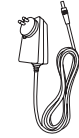

Adapter ** (Surround R/L)



Adaptor Accessories



4 X
4 X
Soundbar and Surround R/L Wall Bracket Screws (for walls)



2 X
Surround R/L Wall Bracket screws (for Surround R/L)

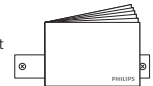

Quick start guide Wall Mount Template

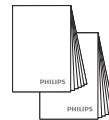

Warranty Card Safety Sheet

- * Power cord quantity and plug type vary by regions.
- Images, illustrations and drawings shown on this User Manual are for reference only, actual product may vary in appearance.
- Please use HDMI cable with ferrite core for this product.

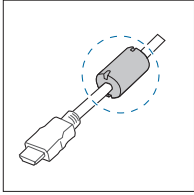

Main unit

This section includes an overview of the main unit.

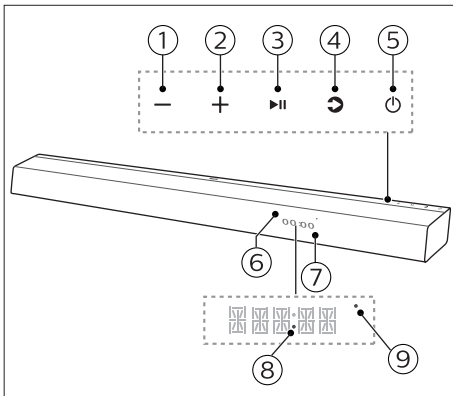

- ① - (Volume) button
Decrease the volume.
- ② + (Volume) button
Increase the volume.
- ③ ▶|| (Play/Pause) button
Start, pause or resume play.

- ④ ↻ (Source)/Bluetooth pairing button
 - Select an input source for the Soundbar.
 - Press and hold to activate the pairing function in Bluetooth mode or disconnect the existing paired Bluetooth device.

- ⑤ ⏻ (Standby-On) button

Power State	Action	Function
On		<ul style="list-style-type: none"> • Follow source state
Semi Standby	Press the ⏻ button once	<ul style="list-style-type: none"> • Wi-Fi is still on. • It still supports Airplay 2 and Chromecast for Audio.
Eco Standby (Wi-Fi is on)	Press and hold ⏻ button 2 seconds. Power LED turns on.	<ul style="list-style-type: none"> • Wi-Fi is on. • The product enters the lower power consumption mode. • Restarting the system will take a relatively longer time.
Eco Standby (Wi-Fi is off)	Press the ⏻ button once. Power LED turns on.	<ul style="list-style-type: none"> • Wi-Fi is off. • The product enters the lower power consumption mode. • Restarting the system will take a relatively longer time.

- ⑥ Display panel
- ⑦ Remote Control Sensor
- ⑧ Power LED
- ⑨ Wi-Fi LED indicator (Yellow)

LED State	Status
Blink	Wi-Fi Access Point (AP) mode
Double blink	Wi-Fi Protected Setup (WPS) mode
Constant on	Connected / Pairing successful

Main unit Connectors

This section includes an overview of the connectors available on your Soundbar.

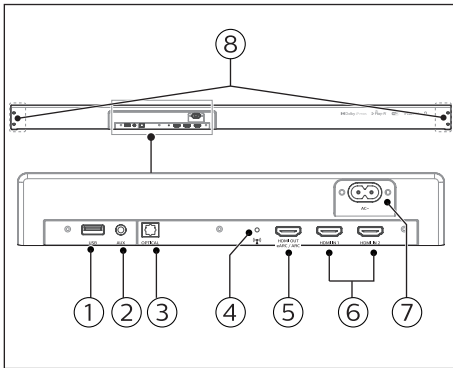

- ① **USB**
 - Audio input from a USB storage device.
 - Upgrade software of this product.
- ② **AUX**

Audio input from, for example, an MP3 player (3.5mm jack).
- ③ **OPTICAL**

Connect to an optical audio output on the TV or a digital device.
- ④ **(Wi-Fi Setup) button**
 - Trigger Wi-Fi setup.
 - Press and hold the button for 5 seconds to activate the Wps mode.
 - Press and hold the button for 20 seconds to reset the Wi-Fi settings.
- ⑤ **HDMI OUT (eARC/ARC)**

Connect to the HDMI input on the TV.

- ⑥ **HDMI 1/ HDMI 2**

Connect to the HDMI input on the TV.
- ⑦ **AC~ Socket**

Connect to the power supply.
- ⑧ **Wall bracket slot**

Surround R/L

This section includes an overview of the Surround R/L

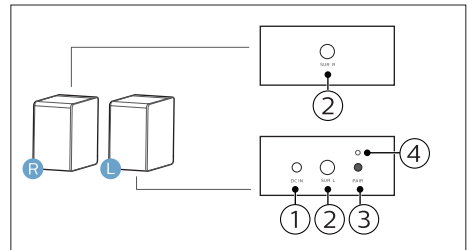

- ① **DC IN Socket**

Connect to the power supply.
- ② **RCA Cable port**

Use the RCA cable to connect the Left and Right Surround sound.
- ③ **PAIR button**

Surround R/L can automatically link to the soundbar. If not, press this button 5 seconds to link again.
- ④ **PAIR LED indicator (Red)**

Determine the status based on the PAIR indicator.

LED State	Status
Fast blink	Surround R/L in pairing mode.
Slow blink	Pairing Failed.
Constant on	Connected / Pairing successful

Wireless subwoofer

This section includes an overview of the Wireless subwoofer.

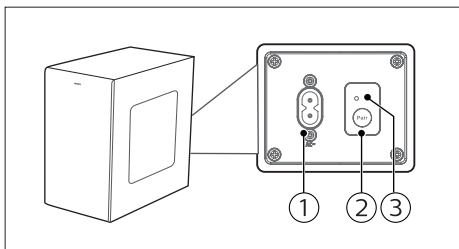

- ① AC~ Socket
Connect to the power supply.
- ② Pair button
Press and hold for 5 seconds to enter the pairing mode for the subwoofer.
- ③ Subwoofer indicator
Determine the status based on the wireless subwoofer indicator.



LED State	Status
Fast blink	Subwoofer in pairing mode
Slow blink	Pairing Failed
Constant on	Connected / Pairing successful

Remote control

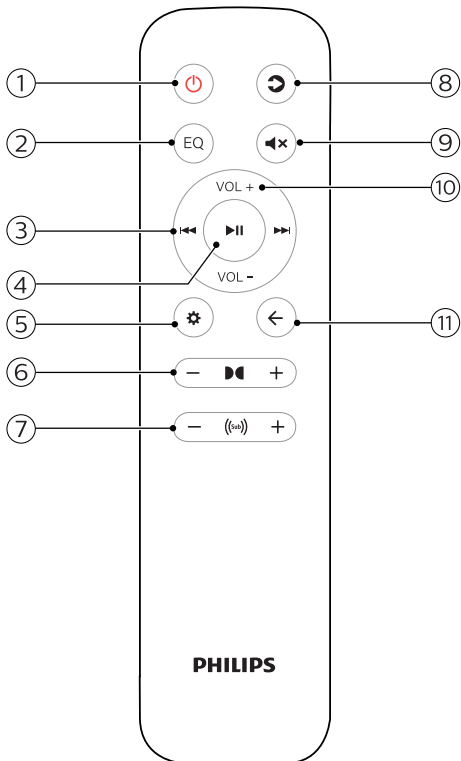
This section includes an overview of the remote control.



① (Standby-On)

Power State	Action	Function
On		<ul style="list-style-type: none">Follow source state
Semi Standby	Press the  button once.	<ul style="list-style-type: none">Wi-Fi is still on.It still supports Airplay 2 and Chromecast for Audio.
Eco Standby (Wi-Fi is on)	Press and hold  button 2 seconds. Power LED turns on.	<ul style="list-style-type: none">Wi-Fi is on.The product enters the lower power consumption mode.Restarting the system will take a relatively longer time.
Eco Standby (Wi-Fi is off)	Press the  button once. Power LED turns on.	<ul style="list-style-type: none">Wi-Fi is off.The product enters the lower power consumption mode.Restarting the system will take a relatively longer time.

② EQ

Select sound modes. (Movie/ Music/Voice/Stadium)

③ Previous/ Next

- Skip to the previous or next track in USB / BT / Google Home app / AirPlay 2 mode.
- Navigate Left/Right in menu structure.

④ (Play/Pause)

- Start, pause or resume play in USB / BT / Google Home app / AirPlay 2 mode.
- Confirm a selection.

⑤ (MENU)

Enter setup menu.

⑥ +/- (Dolby Atmos)

Increase / decrease the top speaker's gain.

⑦ +/- (Subwoofer's Gain)

Increase / decrease the subwoofer's gain.

⑧ (Source)

- Select an input source for the Soundbar.
- Press and hold for 3 seconds to activate the pairing function in Bluetooth mode. Press and hold for 8 seconds to disconnect Bluetooth device.

⑨ (Mute)

Mute or restore volume.

⑩ VOL +/- (Soundbar, Subwoofer and Surround R/L's Volume)

- Increase / decrease the Soundbar, Subwoofer and Surround R/L's volume.
- Navigate Up/Down in menu structure.

⑪ (Back)

- Return to previous menu. Exit menu.

Prepare the Remote Control

- The provided Remote Control allows the unit to be operated from a distance.
- Even if the Remote Control is operated within the effective range 19.7 feet (6m), remote control operation may be impossible if there are any obstacles between the unit and the remote control.
- If the Remote Control is operated near other products which generate infrared rays, or if other remote control devices using infra-red rays are used near the unit, it may operate incorrectly. Conversely, the other products may operate incorrectly.

Replace the Remote Control Battery

The remote control requires AAA battery.

- 1 To replace the batteries, open the battery compartment on the back of the remote control.
- 2 Slide the battery door in the direction shown by the arrow.
- 3 Remove the old battery, which is located in the lid, place the new AAA battery and pay attention to the correct polarity (+/-).
- 4 Reposition the battery door and slide it back until it clicks.

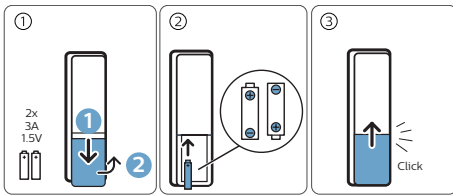

Precautions Concerning Batteries

- When the Remote Control is not to be used for a long time (more than a month), remove the battery from the Remote Control to prevent it from leaking.
- If the batteries leak, wipe away the leakage inside the battery compartment and replace the batteries with new ones.
- Do not use any batteries other than those specified.
- Do not heat or disassemble batteries.
- Never throw them in fire or water.

- Do not carry or store batteries with other metallic objects. Doing so could cause batteries to short circuit, leak or explode.
- Never recharge a battery unless it is confirmed to be a rechargeable type.
- Leaving a battery in an extremely high temperature surrounding environment that can result in an explosion or the leakage of flammable liquid or gas.
- A battery subjected to extremely low air pressure that may result in an explosion or the leakage of flammable liquid or gas.

 **CAUTION** – Risk of explosion

- Risk of fire or explosion if the battery is replaced by an incorrect type.
- Use consumer grade, non-rechargeable carbon-zinc or alkaline batteries AAA type.

Placement

Place the subwoofer at least 1 meter (3 feet) away from your Soundbar, and ten centimeters away from the wall.

For best results, place your subwoofer and Surround R/L as shown below.

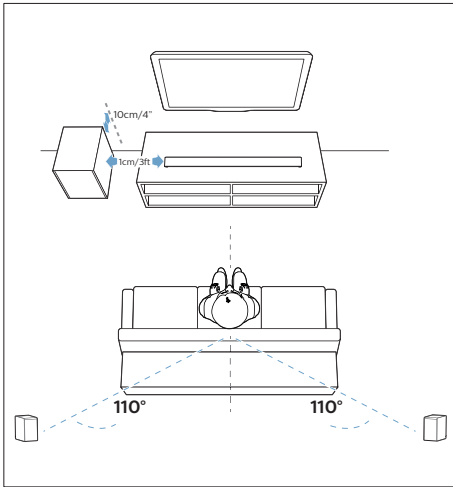

Wall mount



Note

- Improper wall mounting may result in accident, injury or damage. If you have any query, contact Consumer Care in your country.
- Before wall mounting, make sure the wall can support the weight of your Soundbar and Surround R/L.
- Before wall mount, you need not remove the rubber feet at the bottom of the Soundbar, otherwise the rubber feet cannot be fixed back.
- Depending on the type of wall mounting your Soundbar and Surround R/L, make sure that you use screws of a suitable length and diameter.
- Please check whether the USB port on the back of the Soundbar is connected to a USB device. If it is found that the connected USB device affects the wall-mount, you need to use another USB device of the appropriate size.

Screw length/diameter of Soundbar

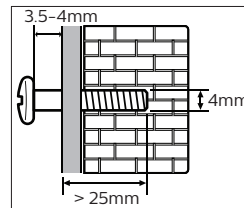

Suggested wall mounting height of Soundbar

You are recommended to install the TV first before wall mounting the soundbar. With a TV preinstalled, wall mount the soundbar 50mm/2.0" in distance from the bottom of the TV.

- 1 Drill 2 parallel holes (\varnothing 3-8mm each according to wall type) on the wall.

- ↳ The distance between the holes are:
 - 1076mm / 42"
- ↳ You can use the wall mount template provided for helping the drilling holes position on the wall
- ↳ Secure the dowels and screws in the holes.

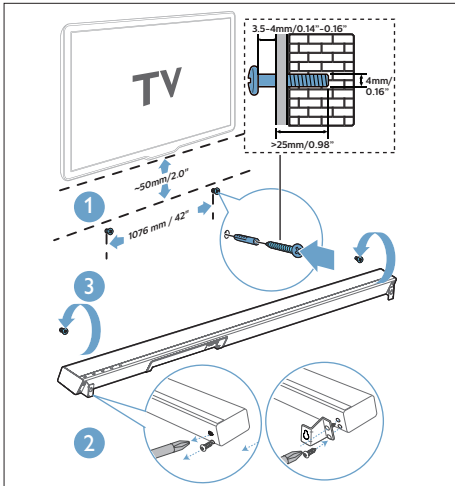

- 2 Remove the screws (x4) from the main unit.
 - ↳ Attach the wall brackets (x2) to the main unit with the screws removed from the main unit.
- 3 Hang the Soundbar on the fastening screws.

Screw length/diameter of Surround R/L

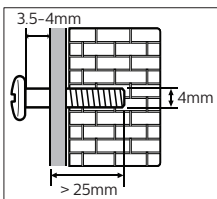

Suggested wall mounting angle of Surround R/L

The suggested angle of the Surround left and right speakers from your sitting position is 110 degrees (see below).

- 1 Drill 2 parallel holes (Ø 3-8mm each according to wall type) on the wall.
 - ↳ Secure the dowels and screws in the holes.

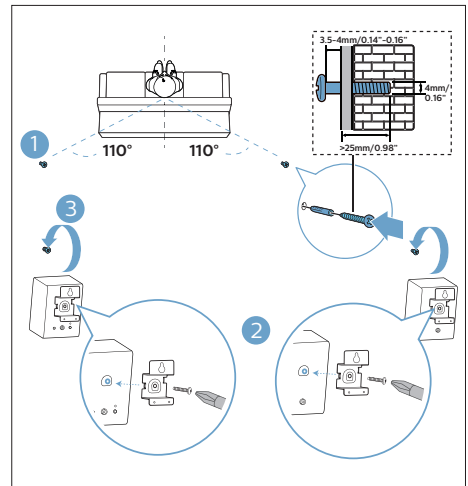

- 2 Attach the wall brackets (x2) to the Surround R/L with screws.
- 3 Hang the Surround R/L on the fastening screws.

3 Connect

This section helps you connect your Soundbar to a TV and other devices, and then set it up.

For information about the basic connections of your Soundbar and accessories, see the quick start guide.

Note

- For identification and supply ratings, see the type plate at the back or bottom of the product.
- Before you make or change any connections, make sure that all devices are disconnected from the power outlet.

- 3 While entering Dolby Atmos / Dolby Digital / PCM format, the soundbar will show DOLBY ATMOS / DOLBY AUDIO / PCM AUDIO / DOLBY SURROUND.

Note

- The full Dolby Atmos experience is only available when the Soundbar is connected to the source via a HDMI 2.0 cable.
- The Soundbar will still function when connected via other methods (such as a Digital Optical cable) but these are unable to support all of the Dolby features. Given this, our recommendation is to connect via HDMI, in order to ensure full Dolby support.

Dolby Atmos®

Dolby Atmos gives you Immersive listening experience by delivering sound in three dimensional space, and all the richness, clarity, and power of Dolby sound.

For more information, please visit dolby.com/technologies/dolby-atmos

For using Dolby Atmos®

Dolby Atmos® is available only in HDMI ARC/eARC mode. For the details of the connection, please refer to “HDMI Connection”.

- 1 To use Dolby Atmos® in HDMI 1 / HDMI 2 / HDMI ARC mode, your TV has to support Dolby Atmos®.
- 2 Make sure that “No Encoding” is selected for bitstream in the digital audio output of the connected external device (e.g. Blu-ray DVD player, TV etc.).

Connect to HDMI Socket

Some 4K HDR TVs require the HDMI input or picture settings to be set for HDR content reception. For further setup details on HDR display, please refer to the instruction manual of your TV.

Option 1: eARC/ARC (Audio Return Channel)

Your Soundbar supports HDMI with Audio Return Channel (eARC/ARC). If your TV is HDMI ARC compliant, you can hear the TV audio through your Soundbar by using a single HDMI cable.

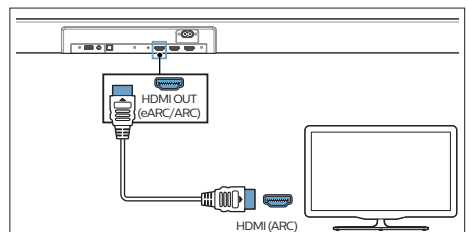

- 1 On your TV, turn on HDMI-CEC operations. For details, see the TV user manual.
 - The HDMI ARC connector on the TV might be labeled differently. For details, see the TV user manual.
- 2 Using a High Speed HDMI cable, connect the HDMI OUT (eARC/ ARC)-TO TV connector on your Soundbar to the HDMI ARC connector on the TV.

Note

- Your TV must support the HDMI-CEC and ARC function. HDMI-CEC and ARC must be set to On.
- The setting method of HDMI-CEC and ARC may differ depending on the TV. For details about ARC function, please refer to your TV owner's manual.
- Make sure to use the HDMI cables can support the ARC function.

Option 2: Standard HDMI

If your TV is not HDMI ARC-compliant, connect your soundbar to the TV through a standard HDMI connection.

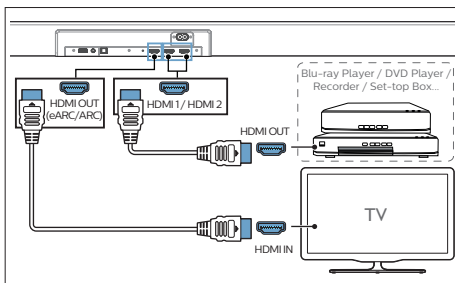

- 1 Use an HDMI cable to connect the soundbar's HDMI IN (1 or 2) socket to your external devices (e.g. games consoles, DVD players and blu ray).
- 2 Use an HDMI cable to connect the soundbar's HDMI OUT (eARC/ARC) socket to the TV's HDMI IN socket.

Connect to Optical Socket

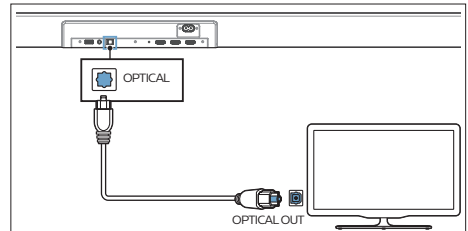

- 1 Using an optical cable, connect the OPTICAL connector on your Soundbar to the OPTICAL OUT connector on the TV or other device.
 - The digital optical connector might be labeled SPDIF or SPDIF OUT.

Connect to AUX Socket

- a. Use a 3.5mm to 3.5mm audio cable
 - Use a 3.5mm to 3.5mm audio cable (not included) to connect the TV's headphone socket to the AUX socket on the unit.

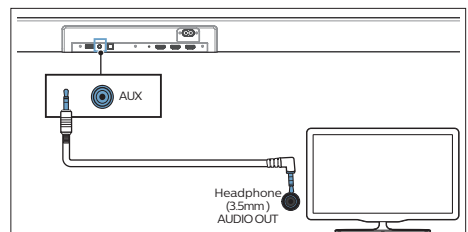

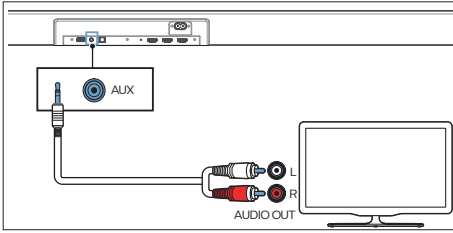

- b. Use a RCA to 3.5mm audio cable
- Use a RCA to 3.5mm audio cable (not included) to connect the TV's audio output sockets to the AUX socket on the unit.

Connect to Power

- Before connecting the AC power cord, ensure you have completed all other connections.
 - Risk of product damage! Ensure that the power supply voltage corresponds to the voltage printed on the back or the underside of the unit.
- 1 Connect the mains cable to the AC~Socket of the unit and then into a mains socket
 - 2 Connect the mains cable to the AC~Socket of the subwoofer and then into a mains socket.
 - 3 Connect the adapter cable to the DC IN port of the Right Surround and then into a mains socket.

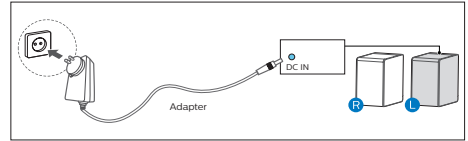
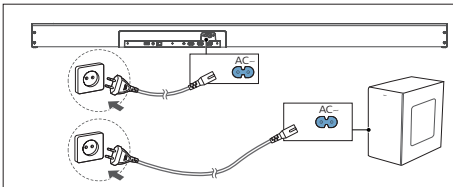

* Power cord quantity and plug type vary by regions.

* Adapter type vary by regions. Please refer to Quick Start Guide for Adapter Accessories and Adapter assembly instructions.

Pair up with the subwoofer

Automatic Pairing

Plug the Soundbar and the subwoofer into the mains sockets and then press on the unit or remote control to switch the unit to ON mode. The subwoofer and Soundbar will automatically pair.

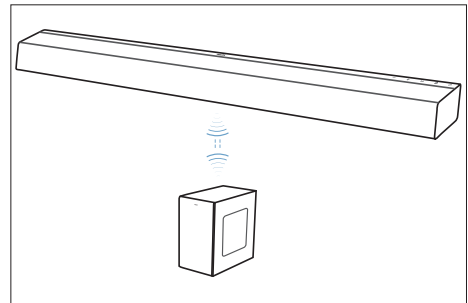

↳ Determine the status based on the wireless subwoofer indicator.

LED State	Status
Fast blink	Subwoofer in pairing mode
Slow blink	Pairing Failed
Constant on	Connected / Pairing successful

Tips

- Do not press Pair button on the rear of the subwoofer, except for manual pairing.

Manual Pairing

If no audio from the wireless subwoofer can be heard, manually pair up the subwoofer.

- 1 Both soundbar and subwoofer are on.
- 2 Press and hold (5 seconds) the Pair button on subwoofer until the subwoofer Red LED blink.
- 3 Press and hold soundbar local keys Play/Pause and Vol+ for 3 seconds.

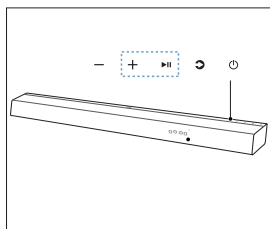

- 4 The soundbar will discover and pair with the subwoofer in pairing mode.
 - ↳ Main unit and subwoofer shall discover each other and pair, main unit display shows "PAIRING".
 - ↳ If pairing succeeds, main unit display shows "SUBWOOFER PAIRED" for 3 seconds.
 - ↳ If pairing fails, main unit display shows "CHECK SUBWOOFER" for 3 seconds. If Soundbar cannot know which device type has failed to pair, main unit will show "CHECK DEVICE" for 3 seconds.

When performing manual pairing, the soundbar must be on. Pairing can only be done one device per time. Refer to Wireless Subwoofer and Wireless Surround Speakers sections for details.

Tips

- The subwoofer should be within 6 m of the Soundbar in an open area (the closer the better).
- Remove any objects between the subwoofer and the Soundbar.
- If the wireless connection fails again, check if there is a conflict or strong interference (e. g. interference from an electronic device) around the location. Remove these conflicts or strong interferences and repeat the above procedures.

Pair up with Surround R/L

Automatic Pairing

- 1 Plug the Soundbar and the Surround R/L into the mains sockets and then press on the unit or remote control to switch the unit to ON mode. The Surround R/L and Soundbar will automatically pair.

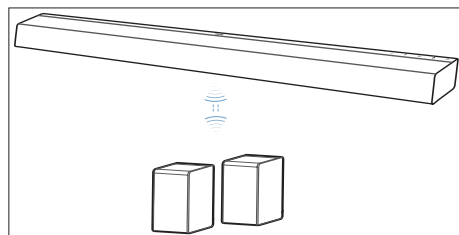

- ↳ Determine the status based on the Surround R/L indicator.

LED State	Status
Fast blink	Surround R/L in Pairing mode
Slow blink	Pairing Failed
Constant on	Connected / Pairing successful

2 Connect the Left and Right Surround with RCA cable.

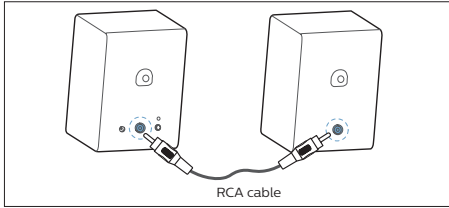

≡ Tips

- Do not press Pair button on the rear of the surround except for manual pairing.

Manual Pairing

If no audio from the Surround R/L can be heard, manually pair up the Surround R/L.

- 1 Both sound bar and wireless surround speakers are on.
- 2 Press and hold (5 seconds) the Pair button on wireless surround speaker until the surround speakers Red LED blink.
- 3 Press and hold Soundbar local keys Play/Pause and Vol+ for 3 seconds.

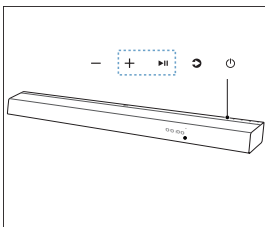

- 4 The soundbar will discover and pair with the surround speakers in pairing mode.
 - ↳ Main unit and surround speakers shall discover each other and pair, main unit display shows “PAIRING”.
 - ↳ If pairing succeeds, main unit display shows “SURR PAIRED” for 3 seconds.
 - ↳ If pairing fails, main unit display shows “CHECK SURR” for 3 seconds. If Soundbar cannot know which device type has failed to pair, main unit will show “CHECK DEVICE” for 3 seconds.

When performing manual pairing, the soundbar must be on. Pairing can only be done one device per time. Refer to Wireless Subwoofer and Wireless Surround Speakers sections for details.

≡ Tips

- The Surround R/L should be within 6 m of the Soundbar in an open area (the closer the better).
- Remove any objects between the Surround R/L and the Soundbar.
- If the wireless connection fails again, check if there is a conflict or strong interference (e. g. interference from an electronic device) around the location. Remove these conflicts or strong interferences and repeat the above procedures.

Connect to Wi-Fi (Wireless Operation)

(For iOS and Android version)

By connecting this unit and mobile phones, tablets (such as iPad, iPhone, iPod touch, Android phones, etc.) to the same Wi-Fi network, you can then use

the Google Home app to control the soundbar.

- 1 Connect your phone or tablet to the same Wi-Fi network that you want to connect your soundbar
- 2 Download and install the latest version of Google Home app on a phone or tablet.

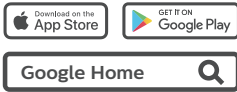

- Make sure your router is turned on and working properly.
- 3 Follow the instructions in the Google Home App to connect this product to your Wi-Fi network (Philips TAB8967SB-xxxx). If success, a sound will be heard from the speaker.
 - 4 After successful Wi-Fi connection, the Wi-Fi light indicator on the front cabinet will stop pulsing and turn solid. Once you set up this product on your Wi-Fi network, you can control it from any smartphone or tablet on the same network.
 - 5 After connection, you can change the device name by Google Home App. Otherwise, it follows the default name.
 - 6 If the ToU (Term of Use) is accepted, after connection, this product may perform a software update. Upgrade to the latest software when it is your first time set up. The software upgrade may take several minutes. Do not unplug your speaker, turn off your device,

or leave the network during the update.

AirPlay 2 setup

To stream using AirPlay 2, connect the soundbar to the same network as the Apple product.

- 1 On your iOS device, go to : Settings > Wi-Fi > SET UP NEW AIRPLAY SPEAKER [Philips TAB8967SB-xxxx]
- 2 Select the speaker, add it to wifi then go next steps as prompt.
 - ↳ Keep the wifi AP (e.g. dlink655) as same as the iOS device's.
 - ↳ After successful Wi-Fi connection, the Wi-Fi light indicator on the front cabinet will stop pulsing and turn solid. Once you set up this product on your Wi-Fi network, you can control it from supported devices on the same network.
- 3 Launch a music app on your Apple device, then play music.
- 4 Click the AirPlay icon 
- 5 In the pop up list, select Philips TAB8967SB-xxxx speaker. Wait a moment music will be casted to speaker.



Note

- If the ToU (Term of Use) is accepted, after connection, the product may perform a software update. Upgrade is required after initial set up. Without the upgrade, not all product features can be available.
- When the first time set up is not successful, hold down the Wi-Fi button on soundbar for 8 seconds until the Wi-Fi light is changed to slow pulse. Reset the Wi-Fi connection, restart the app and start the set up again.
- If you want to change from one network to another, you need to set up the connection again. Press hold down the  (Wi-Fi) button on the soundbar for 8 seconds to reset the Wi-Fi connection.

WPS mode

If your router has Wi-Fi Protected Setup (WPS), you can set up the connection without entering a password.

- 1 Press and hold the Wi-Fi button for 5 seconds. The Wi-Fi light will begin in double blink.
- 2 Press the WPS button on your router. The button is normally marked with this WPS logo.
- 3 Wait for the Wi-Fi LED always turns on.

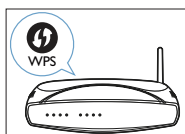

Note

- WPS is not a standard feature on all routers. If your router does not have WPS then use Standard Wi-Fi Setup.
- Press the  (Wi-Fi) button once if you want to exit the WPS mode or it will automatically exit after 2 minutes.

4 Use your Soundbar



This section helps you use the Soundbar to play audio from connected devices.

Before you start

- Make the necessary connections described in the quick start guide and the user manual.
- Switch the Soundbar to the correct source for other devices.

Turn ON and OFF

- When you first connect the unit to the main socket, the unit will be in STANDBY mode. The STANDBY indicator will light up white.

Power State	Action	Function
On		<ul style="list-style-type: none">• Follow source state
Semi Standby	Press the  button once.	<ul style="list-style-type: none">• Wi-Fi is still on.• It still supports Airplay 2 and Chromecast for Audio.
Eco Standby (Wi-Fi is on)	Press the  button once. Power LED turns on.	<ul style="list-style-type: none">• Wi-Fi is on.• The product enters the lower power consumption mode.• Restarting the system will take a relatively longer time.
Eco Standby (Wi-Fi is off)	Press and hold  button 2 seconds. Power LED turns on.	<ul style="list-style-type: none">• Wi-Fi is off.• The product enters the lower power consumption mode.• Restarting the system will take a relatively longer time.

Auto Standby

The unit automatically turns to Standby mode after about 15 minutes if the TV or the external unit is disconnected (or

USB, BT, Airplay 2 and Chromecast for Audio function bit playback pause), switched off.

- To switch the unit off completely, remove the mains plug from the mains socket.
- Please turn the unit off completely to save energy when not in use.

Select Modes

- 1 Press the  button repeatedly on the unit or on the remote control to select the eARC/ARC, OPT, AUX, USB, BT, HDMI 1, HDMI 2 mode.
 - ↳ The selected mode will show on the display.
 - ↳ Airplay 2 and Chromecast for Audio is not an optional source. Need to be directly controlled by APP.

Adjust the Volume

Adjust Soundbar, Subwoofer and Surround R/L's Volume

- 1 Press Vol+/Vol- (Volume) to increase or decrease a volume level.
 - To mute sound, press Mute.
 - To restore the sound, press Mute again or press Vol+/Vol- (Volume).

While adjusting the volume of Soundbar, the volume of Surround R/L and Subwoofer will be adjusted at the same time.

Dolby sound mode

Experience an immersive audio experience with Dolby sound modes.

- 1 Press the  (MENU) button on the remote control to select UPMIX or Standard mode.
 - UPMIX: Create a Dolby listening experience.
 - Standard: Two-channel stereo sound. Ideal for listening to music.

Factory Reset

Reset device to default setting

Set is ON, press and hold the Vol+ and Vol- buttons on the soundbar for 8 seconds until the soundbar display panel shows “RESET”. While system reboot, soundbar display panel shows “REBOOT”.

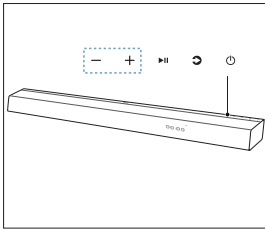



Setup Menu

The unit allows you to configure advanced settings to provide you with an even better experience.

- 1 Press the  (MENU) button on the remote control to open the menu.
- 2 Select the content with VOL+/VOL- (Down / Up) on the remote controller.

Display 	Description
UPMIX / STANDARD	Select Surround Effect
B X X	Adjust the Bass Level

T X X	Adjust the Treble Level
SYNC X X	Set the Audio Delay
C T X X	Adjust the Center Channel Gain
SL X X	Adjust the Surround Left Channel Gain
SR X X	Adjust the Surround Right Channel Gain
DIM	Set display brightness
DISP X X X	Auto turn off display
BT PAIR	Activate the pairing function in Bluetooth mode This item will only be displayed in Bluetooth mode
MANUAL UPGRADE	Activate firmware upgrade
AUTO UPGRADE	ACCEPT TERMS OF USE IN MANUAL - PRESS PLAY(if 1st time switch from OFF to ON)

- 3 Change the initial values for each of the settings with the cursors  /  (Left / Right).
- 4 To return to the previous screen/ exit the settings, press  (Back). If no button is pressed within 10 seconds, the system will automatically exit the menu

Surround

- UPMIX : Dolby up-mixing technology apply for audio channels lesser than the 5.1.2 or 7.1.2 speaker configuration.
- STANDARD : The speaker output follow the native channel configuration of the content.

Tips

- UPMIX support content input only as following: PCM 2.0/Dolby 5.1/Dolby 7.1

BASS

Adjust the Bass Level.

- ↳ BAS -5 ~ BAS +5
- ↳ By default, the Bass is set to 0.

TREBLE

Adjust Treble Level.

- ↳ TRB -5 ~ TRB +5
- ↳ By default, the Treble is set to 0.

SYNC

This function is only available for sources : HDMI 1/HDMI 2/ARC/Optical)

Set the Audio Delay.

- Video image processing, sometimes longer than the time required to process the audio signal. This is called “delayed.” Audio Delay feature is designed to remedy this delay.
- Set the audio delay, provided only for the current playback mode. (As provided in the HDMI ARC audio delay mode, the delay mode is valid only for the HDMI ARC).
 - ↳ AV00 ~ AV200
 - ↳ By default, the audio delay is set to 00.

CHVOL(C)->

Adjust the Center Channel Gain.

- ↳ CT -5 ~ CT +5
- ↳ By default, the center channel Gain is set to 0.

CHVOL(SL)->

Adjust the Surround Left Channel Gain.

- ↳ SL -5 ~ SL +5
- ↳ By default, the surround left channel Gain is set to 0.

CHVOL(SR)->

Adjust the Surround Right Channel Gain.

- ↳ SR -5 ~ SR +5
- ↳ By default, the surround right channel Gain is set to 0.

DIM

Set display brightness.

- ↳ HIGH / MID / LOW.
- ↳ By default, the dimmer is set to MID.

DISP XXX

Set to turn off the display automatically (except the Wi-Fi LED indicator) after 3 seconds of idle when no user operation.

- ↳ ON: Set to display on
- ↳ OFF: Set to display off
- ↳ By default, the display is set to ON.

BT PAIR (NOTE 1)

At BT Source :

- ↳ Long press 3 secs and release SOURCE key to trigger BT pairing.
- ↳ Long press 8 secs will clear pairing info.

MANUAL UPGRADE

- ↳ a. Download TAB8967 firmware from P4C website.
- b. Download TAB8967 firmware from server :

After triggered manual upgrade via Settings menu, Soundbar will check if new firmware is available in the USB flash drive. Once new firmware is detected,

Soundbar will show “UPDATE FROM USB” and start firmware upgrading process.

If there is no new firmware found in USB flash drive, Soundbar will prompt end user to accept ToU (Terms of Use) via local display “ACCEPT TERMS OF USE IN USER MANUAL - PRESS PLAY”, if ToU has not been accepted.

If user do not accept the ToU, software upgrade over the network will not take place.

If ToU has been accepted, Soundbar will perform firmware upgrade if a new firmware is detected from the server.

If there is no new firmware found, Soundbar will scroll current firmware version once and resume to normal operation.

During manual firmware upgrading process, there are downloading and flashing processes.

Downloading process :

- TAB8967 can operate normally.
- POWER key to enter semi standby, downloading will continue. Display should keep displaying “UPDATING-KEEP POWER ON”. During this stage, all local and RC keys will have no effect until firmware is upgraded successfully.
 - During semi standby, in case downloading has failed due to server or network

issues, TAB8967 should cancel the downloading process and stay in standby.

- POWER key to enter ECO standby will interrupt downloading progress and user needs to trigger firmware upgrading manually again.

Flashing firmware process :

- All local and RC keys will have no effect.
- All current sources such as C4A/Aiplay streaming, BT streaming, HDMI In, Optical, etc will stop its current operation. This is to ensure upgrading process will not be interrupted.
- Keep displaying “UPDATING-KEEP POWER ON”.

- ↳ Store the file into “/update/data/” folder of the USB flash drive. The firmware filename should be “update_TAB8967_Vxxxxx.zip”. <xxxxx> is the downloaded firmware version.
- ↳ TAB8967 is turned on.
- ↳ Plug in USB drive with the downloaded firmware.
- ↳ Press SETTINGS on RC, press UP/DOWN to navigate till “MANUAL UPGRADE” item.
- ↳ Press RIGHT key will trigger upgrading. Display will show “UPDATING – KEEP POWER ON” till upgrading has completed.





AUTO UPGRADE

- ↳ Before Auto upgrade is enabled, end user needs to read and accept the Terms of Use in manual.
- ↳ To turn on the AUTO upgrade function, Press SETTINGS on RC, press UP/DOWN to navigate till “AUTO UPGRADE” item.
- ↳ Press RIGHT and display will show “ACCEPT TERMS OF USE IN MANUAL – PRESS PLAY”
- ↳ If end user has agreed, press PLAY to turn on the function.
- ↳ Once it's turned on, TAB8967 will check if any new firmware available from server at certain time interval daily.
- ↳ If there's new firmware found, TAB8967 will download and upgrade the firmware when TAB8967 is going to standby.
- ↳ Once TAB8967 is going to standby, upgrading process will start. Display will show “UPDATING – KEEP POWER ON” till upgrading has completed.

Bluetooth® Operation

Through Bluetooth, connect the Soundbar with your Bluetooth device (such as an iPad, iPhone, iPod touch, Android phone, or laptop), and then you can listen to the audio files stored on the device through your Soundbar speakers.

- 1 Press the  button for 3 seconds repeatedly on the unit or on the remote control to switch the Soundbar to Bluetooth mode.

- 2 On the Bluetooth device, switch on Bluetooth, search for and select Philips TAB8967-xxxx to start connection (see the user manual of the Bluetooth device on how to enable Bluetooth).
- 3 Wait until you hear the voice prompt from the Soundbar.
 - ↳ If the successfully connected, BT is displayed on the display panel.
- 4 Select and play audio files or music on your Bluetooth device.
 - During play, if a call is coming, music play is paused. Play resumes when the call ends.
 - If your Bluetooth device supports AVRCP profile, on the remote control you can press  /  to skip to a track, or press  to pause/resume play.
- 5 To exit Bluetooth, select other source.
 - When your switch back to Bluetooth mode, Bluetooth connection remains active.
 - If you want to connect your Soundbar with another Bluetooth device, press and hold  for 8 seconds on the remote control to disconnect the currently connected Bluetooth device.

Note

- A Bluetooth device which supports Bluetooth profile A2DP, AVRCP and with Bluetooth version as 4.2 + EDR.
- The maximum operational range between the Soundbar and a Bluetooth device is approximately 10 meters (30 feet).
- Compatibility with all Bluetooth devices is not guaranteed.
- The music streaming may be interrupted by obstacles between the device and Soundbar, such as wall, metallic casing that covers the device, or other devices nearby that operate in the same frequency.

AUX / OPTICAL / HDMI ARC Operation

Ensure that the unit is connected to the TV or audio device.

- 1 Press the  button repeatedly on the unit or on the remote control to select the AUX, OPTICAL, HDMI eARC/ARC, HDMI 1, HDMI 2 mode.
- 2 Operate your audio device directly for playback features.
- 3 Press the VOL +/- buttons to adjust the volume to your desired level.

Tip

- While in OPTICAL/HDMI ARC mode, if there's no sound output from the unit and the status Indicator flashes, you may need to activate **PCM** or **Dolby** Digital Signal output on your source device (e.g. TV, DVD or Blu-ray player).
- The unit may not be able to decode all digital audio formats from the input source. In this case, the unit will mute. This is NOT a defect. Ensure that the audio setting of the input source (e.g. TV, game console, DVD player, etc.) is set to PCM or Dolby Digital (Refer to the user manual of the input source device for its audio setting details) with HDMI 1 / HDMI 2 / HDMI ARC / optical input.
- In HDMI mode, when the DOLBY ATMOS audio format is entered, the Soundbar display shows DOLBY ATMOS.
- When the DOLBY DIGITAL audio format is entered, if surround sound is turned on, the whispering wall display will display DOLBY SURROUND, if surround sound is turned off, it will display DOLBY AUDIO.
- When the PCM audio format is entered, the Soundbar display shows PCM AUDIO.
- When entering non-PCM or DOLBY DIGITAL audio formats, if there's no sound output from the unit and the display show ERROR.



USB Operation

Enjoy audio on a USB storage device, such as an MP3 player and USB flash memory, etc.

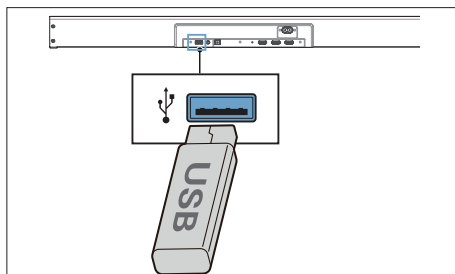
- 1 Insert the USB device.



- 2 Press the  button repeatedly on the unit or on the remote control to select the USB mode.
- 3 During playback:

Button	Action
	Start, pause or resume play.
	Skip to the previous or next track.

Tips

- This product may not be compatible with certain types of USB storage devices.
- If you use a USB extension cable, USB hub, or USB Multifunctional card reader, the USB storage device may not be recognized.
- Do not remove the USB storage device while reading files.
- The unit can support USB devices with up to 32 GB of memory.
- This unit can play MP3 / WAV / FLAC.
- Support a USB port: 5V --- 500mA.
- Only support FAT file system.

Upgrade Firmware

To get the best features and support, update your product with the latest firmware version.

Update firmware via USB

- 1 Check if there is the latest firmware version on www.philips.com/support. Search for your model and click on “Software and drivers”.
- 2 Download the firmware into a USB flash drive.
- 3 Follow the instruction for the firmware upgrade.

5 Product specifications



Note

- Specifications and design are subject to change without notice.

Bluetooth® / Wireless

- Bluetooth Profiles: A2DP, AVRCP
- Bluetooth Version: 5.0
- Frequency Band/Output Power: 2400 MHz ~ 2483.5 MHz / $\leq 5\text{dBm}$
- 2.4G Wireless Frequency Range / Output Power: 2400 MHz~2483 MHz / $\leq 6\text{dBm}$

Network supported

- WiFi IEEE 802.11a/b/g/n/ac
Wireless Frequency Band (Wi-Fi) / Radio Frequency Power Transmitted
2.4G Wi-Fi: 2400 MHz~2483.5 MHz / $\leq 20\text{dBm}$
5.1G Wi-Fi: 5150 MHz~5350 MHz / $\leq 20\text{dBm}$
5.8G Wi-Fi: 5725 MHz~5850 MHz / $\leq 14\text{dBm}$

Main unit

- Power Supply: 100~240V~ 50/60Hz
- MAX Output Power by speaker: 150 W
- Power Consumption: 15 W
- Standby Consumption: $< 0.5\text{ W}$
- USB: 5V = 500mA
- Frequency Response: 150Hz - 20KHz
- Audio Input Sensitivity: 2V
- Speakers Impedance: $8\Omega \times 8$

- Dimension (W x H x D): 1120 x 64 x 113 mm
- Weight: 3.94 kg
- Operating Temperature: 0°C - 45°C

Subwoofer

- Power Supply: 100~240 V~, 50~60 Hz
- Output Power: 180 W
- Power Consumption: 12 W
- Standby Power Consumption: $< 0.5\text{ W}$
- Frequency Response: 35Hz - 150Hz
- Impedance: 3Ω
- Dimensions (W x H x D): 230 x 407 x 400 mm
- Weight: 8.32 kg
- Operating Temperature: 0°C - 45°C

Surround R/L

- Power Supply: DC24V/2A
- Output Power: 60 W
- Power Consumption: 48 W
- Standby Power Consumption: $< 0.5\text{ W}$
- Frequency Response: 150Hz - 20KHz
- Impedance: $8\Omega \times 2$
- Dimensions of L/R (W x H x D): 90 x 134.5 x 108 mm
- Weight: Left and Right 1.23 kg
- Operating Temperature: 0°C - 40°C

Remote control

- Distance/Angle: 6m/15°
- Battery Type: AAA

Supported Audio formats

- HDMI eARC/ARC
Dolby Digital, Dolby Digital plus, Dolby True HD, Dolby Atmos®, LPCM 2ch/Mch, Dolby MAT.

- HDMI IN1/ HDMI IN2
Dolby Digital, Dolby Digital plus, Dolby True HD, Dolby Atmos®, LPCM 2ch/Mch, Dolby MAT.
- OPTICAL
Dolby Digital, LPCM 2ch
- Bluetooth®
SBC
- USB
MP3 / WAV / FLAC
- Video
Video Enhancement: 4K Video Pass-through, Dolby Vision, HDR10, HDR10+, HLG

Wireless information transmission equipment operating in the 5.25–5.35 GHz frequency band is limited to indoor use only.

Avoid interfering with the operation of nearby radar systems.

High-gain directional aerials can only be used in fixed point-to-point systems.

Technical specifications for low-power radio frequency equipment

Without approval, businesses, shops or users are not permitted to change the frequency, increase the power or change the original design characteristics and functions of the low-power RF equipment certified by inspection. The use of low-power radio frequency equipment must not affect flight safety or interfere with lawful communications. If any interference is discovered, it should be stopped immediately and improved to ensure no interference before continuing use. The aforementioned lawful communication refers to radio communication operated in accordance with the provisions of the Telecommunications Management Act. Low-power radio frequency equipment must withstand interference from lawful communications or electrical equipment used for radio wave radiation in industrial, scientific and medical applications.

6 Terms of Use and Privacy Statement

Read the Terms of Use and Privacy Statement on the websites below.

Privacy Statement :

<https://cloud.tpvava.com/docs/tab8967/ps-en.pdf>

Terms of Use :

<https://cloud.tpvava.com/docs/tab8967/tou-en.pdf>

7 Troubleshooting



Warning

- Risk of electric shock. Never remove the casing of the product.

To keep the warranty valid, never try to repair the product yourself.

If you have problems using this product, check the following points before you request service. If you still have a problem, get support at www.philips.com/support.

Main unit

The buttons on the main unit do not work.

- Disconnect from the power supply for a few minutes, then connect again.

No power

- Ensure that the AC cord is properly connected.
- Ensure that there is power at the AC outlet.
- Press standby button on the remote control or Soundbar to turn the Soundbar on.

Sound

No sound from the soundbar speaker.

- Connect the audio cable from your soundbar to your TV or other devices. However, you do not need a separate audio connection when:
 - the soundbar and TV are connected through HDMI ARC connection, or
 - a device is connected to the HDMI IN connector on your soundbar.
- On the remote control, select the correct audio input.

- Make sure that the soundbar is not muted.
- Reset this product to its factory settings (see 'Apply factory settings').

No sound from the wireless subwoofer.

- Manually connect the subwoofer to the main unit.
- Increase the volume. Press Volume Up on the remote control or on the Soundbar.
- When using either of the Digital input, if there is no audio:
 - Try setting the TV output to PCM or
 - Connect directly to your Blu-ray/ other source, some TVs do not pass through digital audio.
- Your TV may be set to variable audio output. Confirm that the audio output setting is set to FIXED or STANDARD, not VARIABLE. Consult your TV's user manual for more detailed information.
- If using Bluetooth, ensure that the volume on your source device is turned up and that the device is not muted.
- When the playback freezes and there is no sound in Wi-Fi mode, please check whether your home network is normal.

Distorted sound or echo.

- If you play audio from TV through this product, make sure that the TV is muted.

Audio and video are not synchronized.

- Press to synchronize the audio with the video.

Bluetooth®

A device cannot connect with the soundbar.

- The device does not support the compatible profiles required for the soundbar.

- You have not enabled the Bluetooth function of the device. See the user manual of the device on how to enable the function.
- The device is not correctly connected. Connect the device correctly.
- The soundbar is already connected with another Bluetooth device. Disconnect the connected device, then try again.

Quality of audio play from a connected Bluetooth device is poor.

- The Bluetooth reception is poor. Move the device closer to the soundbar, or remove any obstacle between the device and the soundbar.

I can't find the Bluetooth name of this unit on my Bluetooth device

- Ensure the Bluetooth function is activated on your Bluetooth device.
- Re-pair the unit with your Bluetooth device.

Wi-Fi

Wi-Fi Connection cannot be established.

- Check the availability of WLAN network on the router.
- Place the Wi-Fi router closer to the unit.
- Make sure the password is correct.
- Check the WLAN function or reboot the modem and Wi-Fi router.

Dolby Atmos

Cannot achieve outstanding Dolby Atmos effects.

- For non-HDMI connections (such as use of USB, Bluetooth, OPTICAL or AUDIO IN), limited height surround effects are generated. See the section of 'Dolby Atmos' about

how to achieve best Dolby Atmos effects.

Remote control does not work

- Before you press any playback control button, first select the correct source.
- Reduce the distance between the remote control and the unit.
- Insert the battery with its polarities (+/-) aligned as indicated.
- Replace the battery.
- Aim the remote control directly at the sensor on the front of the unit.

This is a 15 mins power off function, one of the ERPII standard requirement for saving power

- When the unit's external input signal level is too low, the unit will be turned off automatically in 15 minutes. Please increase the volume level of your external device.

The subwoofer is idle or the indicator of subwoofer do not light up

- Please unplug power cord from the mains socket, and plug it in again after 3 minutes.

8 Trademarks



The Wi-Fi CERTIFIED® Logo is a registered trademark of Wi-Fi Alliance®.



Google, Google Play and Chromecast built-in are trademark of Google LLC. Google Assistant is not available in certain languages and countries.



To control this AirPlay 2 -enabled speaker, iOS 11. 4 or later is required. Use of the Works with Apple badge means that an accessory has been designed to work specifically with the technology identified in the badge and has been certified by trademarks of Apply Inc. ,registered in the U. S. and other countries.

Apple® and AirPlay® are trademarks of Apple Inc., registered in the U.S. and other countries.



The terms HDMI, HDMI High-Definition Multimedia Interface, and the HDMI Logo are trademarks or registered trademarks of HDMI Licensing Administrator, Inc.



Dolby, Dolby Atmos and the double-D symbol are registered trademarks of Dolby Laboratories Licensing Corporation.

Manufactured under license from Dolby Laboratories. Confidential unpublished works. Copyright © 2012–2021 Dolby Laboratories. All rights reserved.



The Bluetooth® word mark and logos are registered trademarks owned by Bluetooth SIG, Inc. and any use of such marks by MMD Hong Kong Holding Limited is under license. Other trademarks and trade names are those of their respective owners.



Specifications are subject to change without notice.

Please visit <http://www.philips.com/support> for the latest updates and documents.

Philips and the Philips Shield Emblem are registered trademarks of Koninklijke Philips N.V. and are used under license. This product has been manufactured by and is sold under the responsibility of MMD Hong Kong Holding Limited. or one of its affiliates, and MMD Hong Kong Holding Limited. is the warrantor in relation to this product.

Model names : TAB8967/98, TAB8967VD/98, TAB8967VD

