

User manual



PHILIPS



What's in the box.....	5
Your product.....	6
Wireless multimedia adapter	6
Before you start.....	7
User manual.....	7
Broadband internet.....	7
Wireless home network	7
Safety precautions	7
European regulations.....	8
Need help?	9
Troubleshooting	9
Online help	9
Club Philips	9
Philips Media Manager.....	9
Helpline.....	9
Overview.....	10
Wireless multimedia adapter	10
Remote control	11
Power adapter	12
Install	13
Install the software	13
Install the TV connection	13
Install the digital audio connection (optional)	14
Install the network connection.....	14
Install the power connection.....	15
Install the batteries	15
Connect.....	15
Set the correct TV channel.....	15
Start the configuration wizard.....	15
Enjoy	16
Compression formats	16
Digital Rights Management (DRM).....	16
Turn the product on	16
Start the Philips Media Manager	16
Share a movie file	17
Play a movie file	17
Share a music file.....	18
Play a music file.....	19
Share a picture file	20
Play a picture slideshow.....	20
Play a picture slideshow with music	21
Set to stand-by.....	21

Configure.....	21
Open the Settings menu	21
Overview.....	22
Change the language.....	22
Start the configuration wizard.....	23
Start the network wizard	23
Restore the factory default values	24
Change the slide show interval.....	24
Change the TV shape.....	24
Change the TV system.....	25
Change the image quality	26
Enable the screen saver	27
View the device name	27
View the IP details.....	28
View the connection method.....	28
View the wireless details.....	29
Change the device name	29
Change the IP assignment	30
Change the connection method	31
Register for Internet services.....	32
Upgrade the software	32
Set the bandwidth for Internet media files.....	32
View the product information	33
Troubleshooting	34
Problems and tips.....	34
Technical data.....	35
Video playback	35
Audio playback.....	35
Still picture playback.....	35
Connectivity	35
Software	35
System requirements.....	35
Dimensions	36
Power.....	36
Internet services.....	36
Information	37
Respect copyrights.....	37
Disclaimer	37
Trademarks.....	37
Wireless transmission.....	38
Health and safety.....	38
Maintenance and service.....	38
Disposal of your old product	38
Warranty.....	38
Glossary.....	39
Terms and definitions.....	39

What's in the box

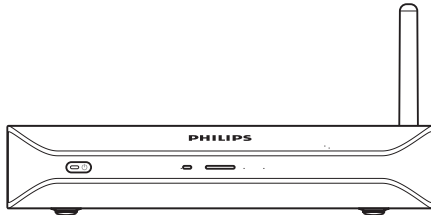

SLM5500
Wireless Multimedia Adapter

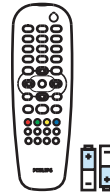

Remote control
2x AA batteries



Quick start guide

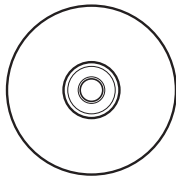

Installation CD

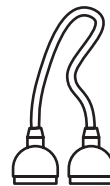

SCART cable

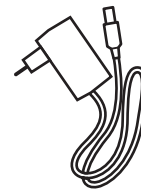

Power cable

What else you'll need



TV
Television



PC
Computer

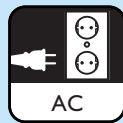

AC
Power supply



WiFi
Wireless network

or

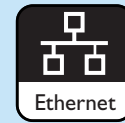

Ethernet
Wired network

Result after installation

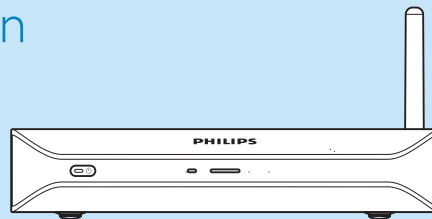

Optional components (not supplied)

Digital audio



Coaxial
audio cable

High-definition television

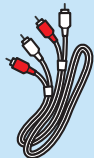

Audio cable
2x RCA



SCART to 3x RCA
output adapter

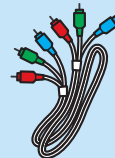

Video cable
3x RCA

Wired network

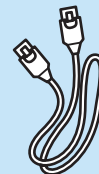

Network cable
(UTP5e Ethernet)

Your product

Wireless multimedia adapter

Watch downloaded movies

Download and store movies on your PC then watch them on your TV from the comfort of your living room couch. No need to burn movies from your hard disk to CD or DVD, just the ease and convenience of wireless access with fingertip control.

You can playback secure WMV (DRM) movies from online movie services and even stream movies from the Internet. The Wireless Multimedia Adapter supports MPEG I, MPEG2, MPEG4, WMV, WMV-DRM, DivX and Xvid video formats.

Enjoy PC music anywhere at home

Stream music files from your PC and listen to them in high quality in any room on your audio system. Keep your music collection stored on your PC's hard disk. Use your remote control to select songs according to artist, album or genre.

You can play secure WMA (DRM) songs from online music services, and even listen to Internet Radio without a PC. The Wireless Multimedia Adapters supports WMA, WMA-DRM, MP3 and AAC-MPEG4 music formats, and so you have access to all your downloaded songs. And you can add more radio stations to your current entertainment system by connecting to online radio stations.

Share your digital photos

Relax on the couch and look at your holiday photos with the whole family or friends. Simply store your photo collections centrally on a PC and enjoy them anytime on your TV. If you have a high-definition TV input on an LCD or plasma TV, your digital photos will be brought to life!

Smart and simple

The Wireless Multimedia Adapter is easily installed thanks to a user-friendly step-by-step approach. All the steps needed to install it are displayed on your TV screen.

You can add new or updated functionality simply by upgrading the software on line. The Wireless Media Adapter checks via a broadband Internet connection for new software versions.

Wireless convenience

You can access multimedia content from other PCs in your house. The media manager works on most PCs, including older types. So with just one Wireless Media Adapter you can access content on several PCs, and there's no need to copy files across. The 2.4 GHz wireless link between the Multimedia Adapter and the PC means you don't have to lay cables or drill holes through walls.

Club Philips: club.philips.com

Check out what you can do with your latest Philips product! Club Philips is your portal to a variety of content, services and product information. Come here for content to enrich your Philips product!

User manual

- Follow the procedures described in the user manual.
- Keep the installation CD for future reference.

Tip The documents of the connected devices can contain additional information. For example, the user manual of your TV.

Broadband internet

- Make sure that you have broadband internet access (> 256 kbps) to use the internet functions of the product.

The Internet service provider can charge extra fees for exceeding a certain limit of transferred data.

Wireless home network

- The performance in a wireless home network is dependent upon the location of the wireless network devices and the structure of the building.

Safety precautions

- You must use the supplied power cable to connect the product to a power supply.
- Do not use the product outdoors.
- The product can cause interference between the product and other devices. Make sure that the interference does not have an effect on the devices that are installed close to the product.
- Do not connect or disconnect devices when the product is connected to a power supply.
- Before you operate the product, make sure that the voltage on the type plate of the product is the same as the voltage of the connected power supply. When the voltages are not the same, refer to your dealer.
- Do not expose the product to moisture or water. Do not put objects that contain liquids on the product (for example, vases).
- Do not expose the product to heat sources (for example, heating equipment or direct sunlight).
- Do not expose the product to sand.
- Make sure that there is enough free space around the product for ventilation.
- Do not open the product. When you have technical difficulties, contact your dealer.

European regulations

The product has been designed, tested and manufactured according to the European R&TTE directive 1999/5/EC. Under this directive, the product can be put into service in the following countries:

SLM5500/00

B	✓	DK	✓	E	✓	GR		F	✓
IRL		I	✓	L	✓	NL	✓	A	✓
P	✓	SU	✓	S	✓	UK		N	✓
D	✓	CH	✓						

SLM5500/05

B		DK		E		GR		F	
IRL	✓	I		L		NL		A	
P		SU		S		UK	✓	N	
D		CH							

Troubleshooting

Refer to page 34.

Online help

Refer to www.philips.com/support for:

- Interactive help
- Frequently asked questions

Club Philips

Refer to club.philips.com for:

- Interactive help
- Internet services

Registration can be required.

Philips Media Manager

Refer to the embedded help of the Philips Media Manager software.

Helpline

Country	Telephone number	Costs per minute
België/Belgique/Belgien	070 253 010	€ 0.17
Danmark	3525 8761	
Deutschland	0180 5 007 532	€ 0.20
España	902 888 785	€ 0.15
France	08 9165 0006	€ 0.23
Ireland	01 601 1161	
Italia	199 404 042	€ 0.21
Luxemburg/Luxembourg	26 84 30 00	
Nederland	0900 0400 063	€ 0.20
Norge	2270 8250	
Österreich	0820 901115	€ 0.20
Portugal	2 1359 1440	
Schweiz/Suisse/Svizzera	02 2310 2116	
Suomi	09 2290 1908	
Sverige	08 632 0016	
United Kingdom	0906 1010 017	£ 0.15

Be prepared to give this information:

- A description of the problem and when it occurs
- The type number on the label of the product
- The date of purchase

Overview

Wireless multimedia adapter

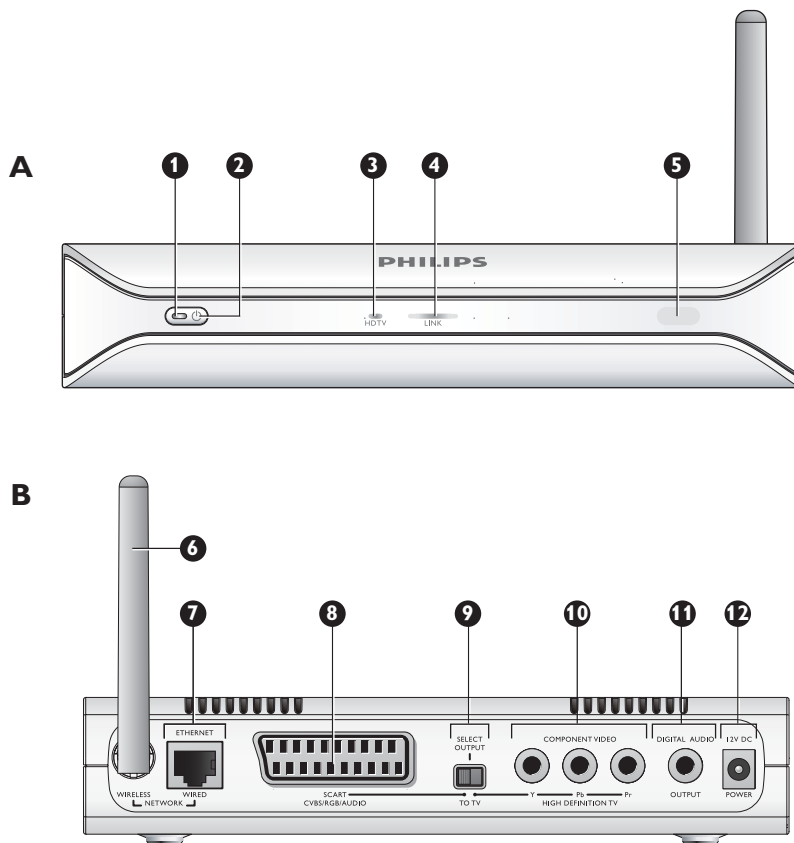

1 On/off light

Shows the on/off status of the product.

- Off - Not connected to a power supply
- Red - Stand-by mode
- Blue - On

2 On/off button

Turns the product on and off.

3 High-definition TV light

Indicates the type of video signal.

- Off - Standard definition video signal
- Blue - High-definition video signal

4 Link light

Indicates the status of the network connection.

- Off - No network connection
- Flashing - Connecting to network, or
- Flashing - Searching for a media file server, or
- On - Connection to a network and media file server found

5 Infra-red receiver

Receives the infra-red signals from the remote control.

6 Wireless network antenna

Receives signals from and sends signals to the wireless network.

7 Ethernet port

Connects a network cable (UTP5e Ethernet) to a wired network.

- 8 SCART port**
Connects a SCART cable to all types of TVs.
- 9 Video output switch**
 - Left - The SCART port is used
 - Right - The component video port is used
- 10 Component video port**
Connects a video cable to a high-definition TV.
- 11 Digital audio port**
Connects a coaxial audio cable to a digital audio system.
- 12 Power socket**
Connects the power cable to a power supply.

Remote control

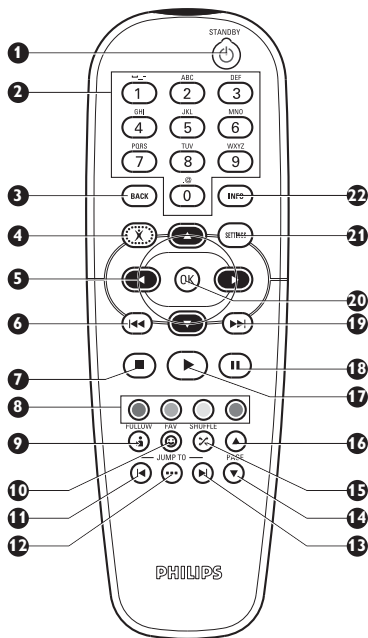

- 1 Stand-by button**
Turns the product on and off.
- 2 Number keys**
Enter digits and texts.
- 3 Back button**
 - Text or digit entry - Backspace
 - Navigation - Back
- 4 Home button**
 - Navigation - Opens the home menu
- 5 Up, down, left and right buttons**
 - Navigation - Go in the specified direction
- 6 Previous/Rewind button**
 - Movies - Rewind (long press)
 - Movies, music, pictures - Previous (short press)
- 7 Stop button**
 - Movies, music, pictures - Stops the media file
- 8 Colour buttons**
The functions of the buttons is shown by the TV.
- 9 Follow me button**
For future use.
- 10 Favourites button**
For future use.
- 11 Jump back**
For future use.
- 12 Jump to button**
For future use.
- 13 Jump forward**
For future use.
- 14 Page down button**
 - Navigation - Go 1 page down
- 15 Shuffle button**
Shuffles the playlist.
- 16 Page up button**
 - Navigation - Go 1 page up
- 17 Play button**
 - Movies, music, picture - Starts the media file
- 18 Pause button**
 - Movies, music, picture - Pauses the media file
- 19 Next/Forward button**
 - Movies - Forward (long press)
 - Movies, music, pictures - Next (short press)
- 20 OK button**
Selects and confirms the current item.
 - Movies, music, pictures - Starts the media file















21 Settings button

- Navigation - Opens and closes the **Settings** menu

22 Info button

- Movies, music, pictures - Shows and hides extra information about the media file

Text and digit entry

Action	Button
Select the available characters	 
Select the next or previous character	 
Confirm a choice	
Select characters . @ 0	
Select characters <space> _ -	
Select characters a b c A B C 2	
Select characters d e f D E F 3	
Select characters g h i G H I 4	
Select characters k l m K L M 5	
Select characters m n o M N O 6	
Select characters p q r s P Q R S 7	
Select characters t u v T U V 8	
Select characters w x y z W X Y Z 9	

Tip To select characters, press the button several times quickly in succession.

Power adapter

1 Power adapter

Connects to the power supply.

2 Power cable connector

Connects to the power socket of the product.

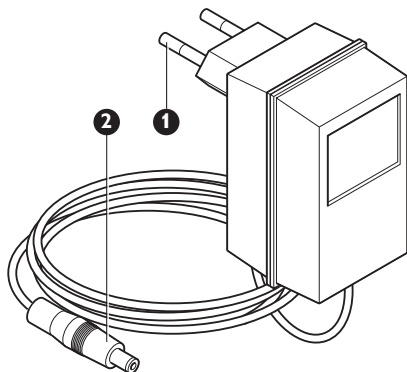

Install the software

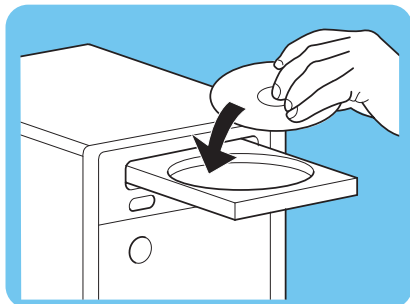

- 1 Put the installation CD in the CD or DVD drive of the computer.
- 2 Click on your preferred language.
- 3 Click on **Install**.
- 4 Click on **Philips Media Manager**.
- 5 Follow the on-screen instructions.

You will be asked to select the folders in which you have put movies, music and pictures. Make sure that you select the correct folders. The movies, music and pictures in the selected folders are available for the product.

Install the TV connection

Option 1, SCART connection for all TVs

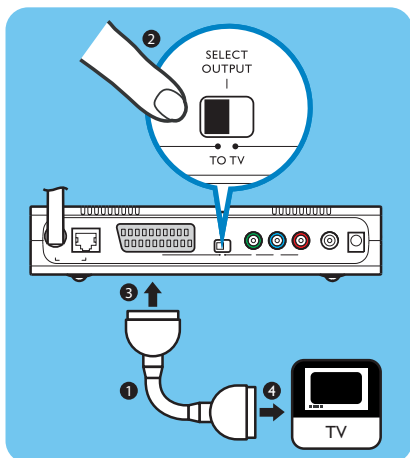

- 1 Take the SCART cable.
- 2 Set the video output switch on the product to the left position.
- 3 Plug one connector into the SCART port on the product.
- 4 Plug the other connector into the SCART port on the TV.
- 5 Manual restart needed.

Option 2, component video connection for high-definition TVs

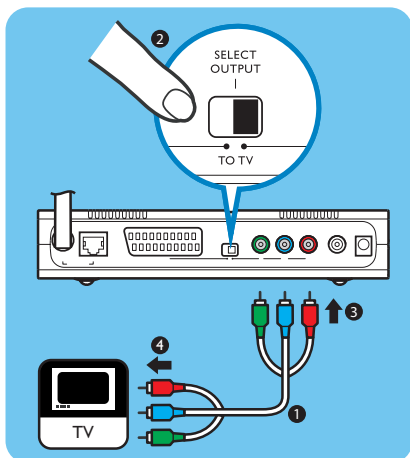

Only for use with TVs that support the YPbPr connection (typically available on LCD or plasma TVs). The YPbPr connection is also known as YUV, 3x RCA (blue, green, red).

- 1 Take a digital video cable (3x RCA, not supplied).
- 2 Set the video output switch on the product to the right position.
- 3 Plug the three connectors into the component video port on the product.
- 4 Plug the other three connectors into the component video port on the TV.

When you connect the YPbPr signal to a Philips TV, a YPbPr adapter can be required. A YPbPr adapter is supplied with some Philips TVs.

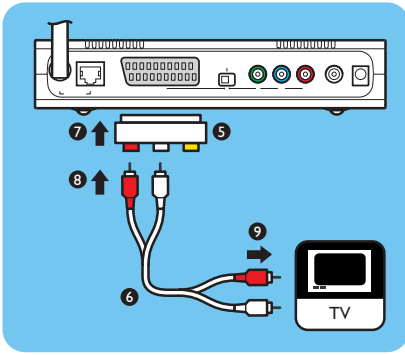

- 5 Take a SCART to 3x RCA output adapter (not supplied).
- 6 Take a stereo audio cable (2x RCA, not supplied).
- 7 Plug the SCART to 3x RCA output adapter into the SCART port on the product.
- 8 Plug the stereo audio cable into the SCART to 3x RCA output adapter.
- 9 Plug the other end into the stereo input on the TV.
- 10 Manual restart needed.

Install the digital audio connection (optional)

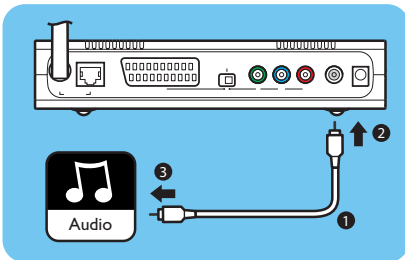

- 1 Take a coaxial audio cable (not supplied).
- 2 Plug one connector into the digital audio port.
- 3 Plug the other end into the digital audio port on the sound system.

Install the network connection

Option 1 - Wireless



- 1 Make sure that the wireless network devices are on.

Option 2 - Wired

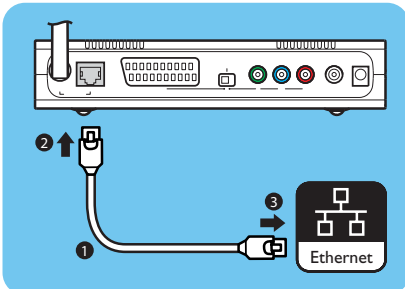

- 1 Take a network cable (UTP5e Ethernet, not supplied).
- 2 Plug one connector into the Ethernet port.
- 3 Plug one connector into the network (for example, the base station or router).

Install the power connection

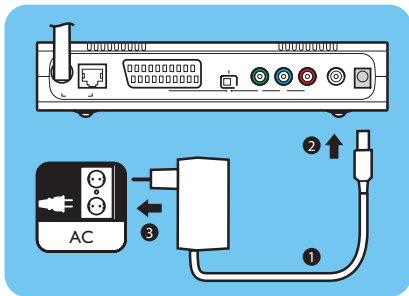

- 1 Take the power cable.
- 2 Plug the connector of the power cable into the power socket of the product.
- 3 Plug the power adapter into the power supply.
 - > *The on/off light on the front of the product comes on as red.*

Install the batteries

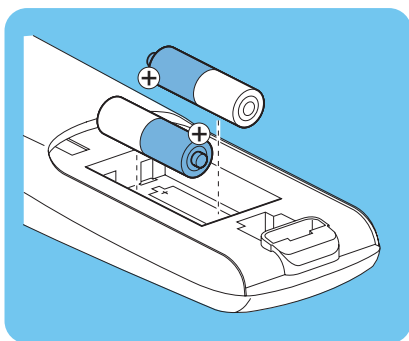

- 1 Open the battery compartment of the remote control.
- 2 Insert the batteries correctly.
- 3 Close the battery compartment.

Connect

Set the correct TV channel

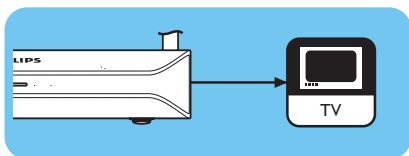





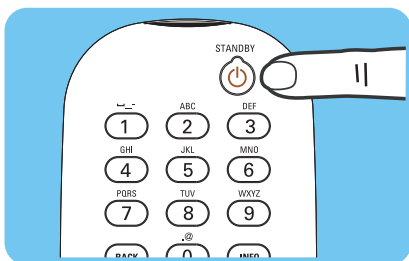

- 1 Turn the TV on.
- 2 Set the TV to the correct external input. Refer to the user manual of the TV for details.

Start the configuration wizard



- 1 Take the remote control.
- 2 Point the remote control at the product.
- 3 Press the stand-by button.
 - > *The on/off light on the front of the product comes on as blue.*
- 4 Follow the on-screen instructions.

Navigation

Action	Button
Go up or down in a list	 
Confirm a choice	 
Select the previous page	
Show help information (when available)	

Compression formats

Before you share or play a media file, make sure that the product supports the compression format of the media file (refer to page 35).

Digital Rights Management (DRM)

DRM protects the integrity of the media file so that the intellectual property, including copyright, in such media file is not misappropriated. Before you share or play a media file with DRM, make sure that the product supports the compression format of the media file with DRM (refer to page 35).





Either – A future version of Philips Media Manager might include the option to stream WM-DRM protected music.

Or – Windows Media Connect can be used to stream WMA-DRM protected music. The Philips SLM5500 must be added to the safe list of Windows Media Connect.

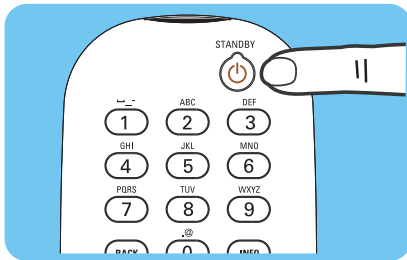
Turn the product on

- 1 Set the correct TV channel.
- 2 Press the stand-by button on the supplied remote control.
 - > *The home menu shows.*



Action	Button
Select the available menu items	 
Select the next or previous menu	 
Confirm a choice	

Start the Philips Media Manager

Microsoft Windows®

- 1 Click on **Start**.
- 2 Click on **All Programs**.
- 3 Click on **Philips Media Manager**.
- 4 Click on **Philips Media Manager**.
 - > *The Philips Media Manager starts.*

Share a movie file

- 1 Start the Philips Media Manager.
- 2 Click on **Movies**.
- 3 Click on **Add Movies**.
- 4 Click on **Add Files or Folders**.
- 5 Add the movie file.
 - > *The properties of the movie file show.*

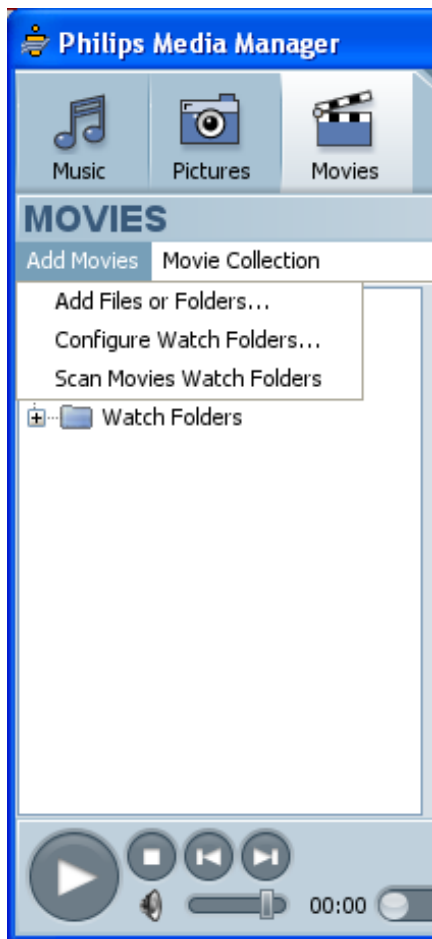

Play a movie file



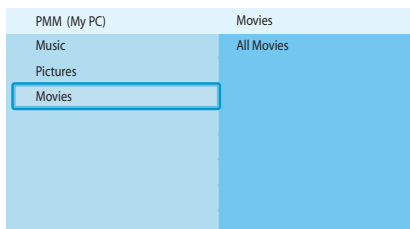
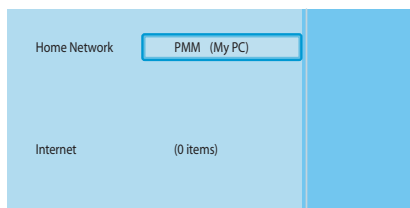



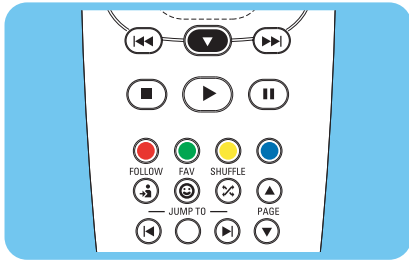

- 1 Share a movie file.
- 2 Turn the product on.
 - > *The home menu shows.*
- 3 Select the media file server that shares the movie file and press **OK**.
 - > *The media files menu shows.*



- 4 Select **Movies** and press **OK**.
 - > *The **Movies** menu shows.*
- 5 Select the movie file.



6 Play the movie file with the supplied remote control.

Action	Button
Start the movie file	 
Go forward in the movie file	 (long)
Go to the next movie file	 (short)
Go back in the movie file	 (long)
Go to the previous movie file	 (short)
Pause the movie file	
Stop the movie file	

Share a music file

- 1 Start the Philips Media Manager.
- 2 Click on **Music**.
- 3 Click on **Add Music**.
- 4 Click on **Add Files or Folders**.
- 5 Add the music file.
 - > *The properties of the music file show.*

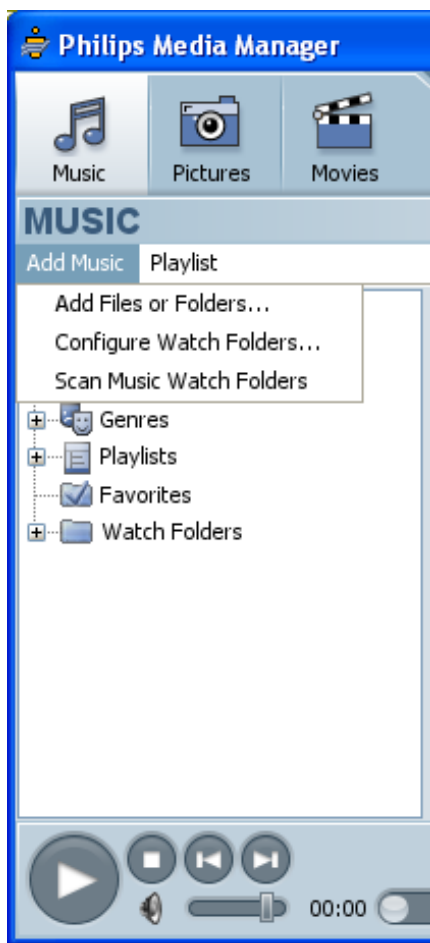

Play a music file



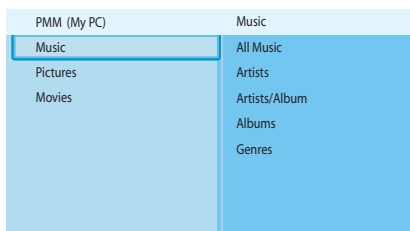
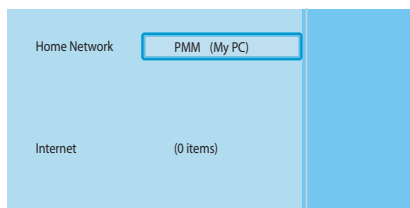

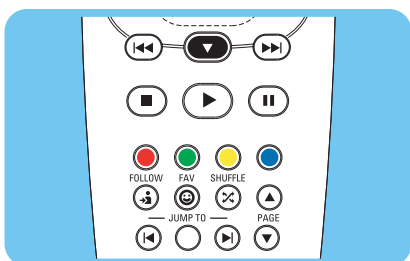

- 1 Share the music file.
- 2 Turn the product on.
> *The home menu shows.*
- 3 Select the media file server that shares the music file and press **OK**.
> *The media files menu shows.*



- 4 Select **Music** and press **OK**.
> *The **Music** menu shows.*
- 5 Select the music file.



- 6 Play the music file with the supplied remote control.

Action	Button
Start the music file	 
Select the next music file	
Select the previous music file	
Pause the music file	
Stop the music file	

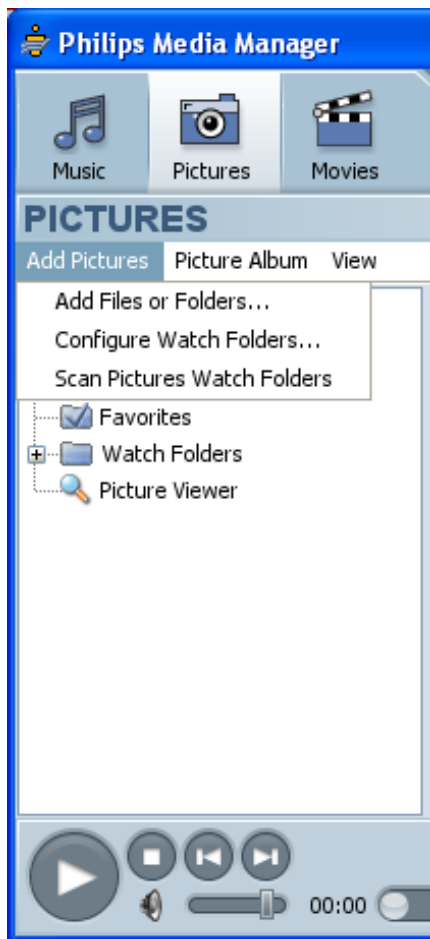

Share a picture file

- 1 Start the Philips Media Manager.
- 2 Click on **Pictures**.
- 3 Click on **Add Pictures**.
- 4 Click on **Add Files or Folders**.
- 5 Add the picture file.
 - > *The properties of the picture file show.*

Play a picture slideshow

- 1 Share the picture files.
- 2 Turn the product on.
 - > *The home menu shows.*
- 3 Select the media file server that shares the picture files and press **OK**.
 - > *The media files menu shows.*

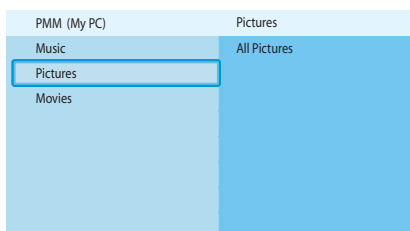
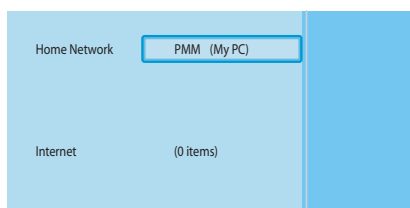

- 4 Select **Pictures** and press **OK**.
 - > *The Pictures menu shows.*

Tip To go to the thumbnail view, press the blue button on the supplied remote control.

- 5 Select the first picture file.

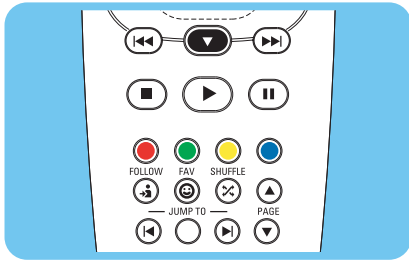

- 6 Play the picture slideshow with the supplied remote control.

Action	Button
Start the picture slide show	
Go to the next picture	
Go to the previous picture	
Pause the picture slide show	
Stop the picture slide show	

Tip To change the settings of the picture slide show, use the **Settings** menu.

Play a picture slideshow with music

- 1 Play the music file.
- 2 Press the home button on the supplied remote control.
- 3 Play the picture slide show.

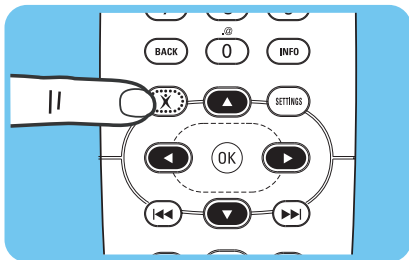

Set to stand-by

- 1 Press the stand-by button on the supplied remote control.
 - > *The on/off light on the front of your product comes on as red.*

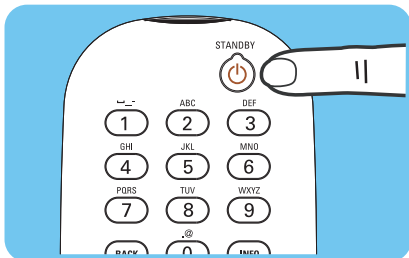

When the product is switched to stand-by, it still uses power. To turn the product off, remove the power adapter from the power supply.

Configure

Open the Settings menu

With the **Settings** menu, you can change the settings of the product.

- 1 Take the supplied remote control.
- 2 Turn the product on.
- 3 Press the settings button.
 - > *The **Settings** menu shows.*

Overview

Setup	Language	
	Configuration wizard	
	Network wizard	
	Factory defaults	
Preferences	Slide show interval	
	TV settings	TV Shape
		TV System
		Image quality
	Screen saver	
Network settings	View	Device name
		IP details
		Connection method
		Wireless details
	Change	Device name
		IP Assignment
		Connection method
Internet services	Register	
	Software upgrade	
	Bandwidth	
Product info		

Change the language

- 1 Open the **Settings** menu.
- 2 Select **Setup** and press **OK**.
> *The Setup menu shows.*
- 3 Select **Language** and press **OK**.
> *The Language menu shows.*
- 4 Select the preferred item and press **OK**.

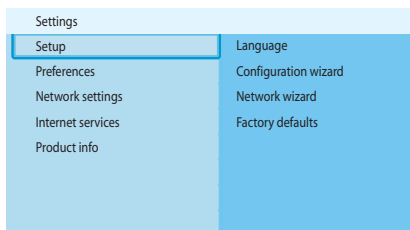

Item	Description
English	English
Français	French
Español	Spanish
Deutsch	German
Nederlands	Dutch
Italiano	Italian

Start the configuration wizard

The configuration wizard starts an automatic process that allows you to configure the settings of the product again.

Use the network wizard to configure the network settings of the product again.

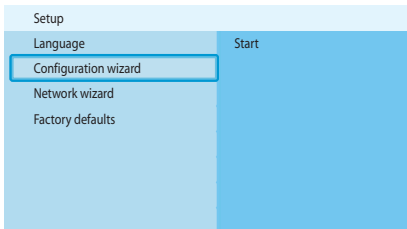
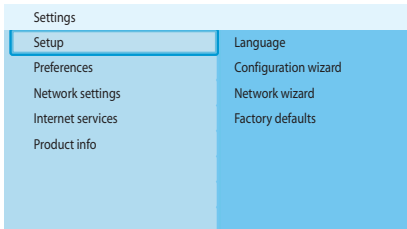

- 1 Open the **Settings** menu.
- 2 Select **Setup** and press **OK**.
> *The Setup menu shows.*

- 3 Select **Configuration wizard** and press **OK**.
> *The configuration wizard starts.*
- 4 Follow the on-screen instructions.

Start the network wizard

The network wizard starts an automatic process that allows you to configure the network settings of the product again.

Use the configuration wizard to configure the other settings of the product again.

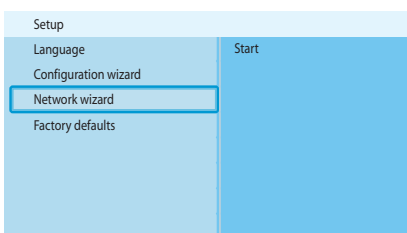
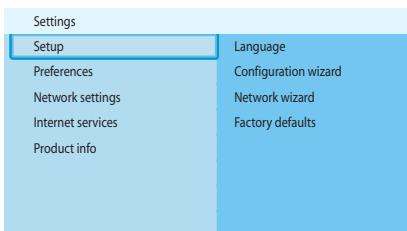

- 1 Open the **Settings** menu.
- 2 Select **Setup** and press **OK**.
> *The Setup menu shows.*

- 3 Select **Network wizard** and press **OK**.
> *The network wizard starts.*
- 4 Follow the on-screen instructions.

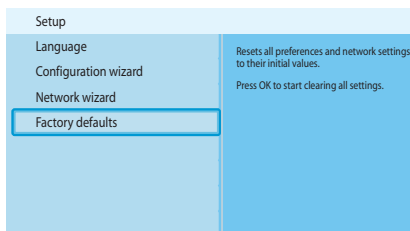
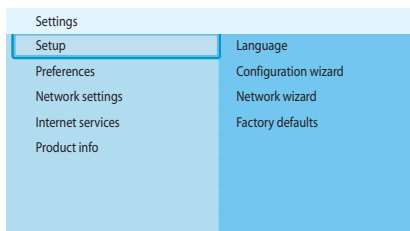

Restore the factory default values

- 1 Open the **Settings** menu.
- 2 Select **Setup** and press **OK**.
> *The Setup menu shows.*

- 3 Select **Factory defaults**.

The next step erases the network settings, configuration settings, personal preferences and Internet registration. To go back to the **Settings** menu, press **BACK**.

- 4 Press **OK**.
> *All settings are erased.*
- 5 Follow the on-screen instructions.

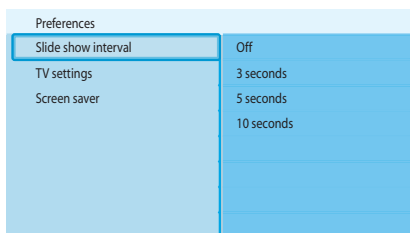
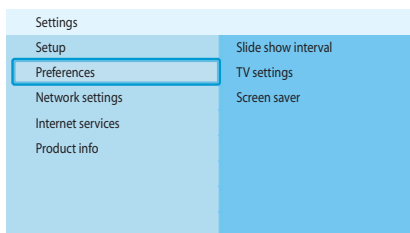

Change the slide show interval

- 1 Open the **Settings** menu.
- 2 Select **Preferences** and press **OK**.
> *The Preferences menu shows.*

- 3 Select **Slide show interval** and press **OK**.
> *The Slide show interval menu shows.*
- 4 Select the preferred item and press **OK**.

Item	Description
Off	Each picture shows until you press the next/forward button.
3 seconds	Each picture shows for 3 seconds.
5 seconds	Each picture shows for 5 seconds.
10 seconds	Each picture shows for 10 seconds.

Change the TV shape

- 1 Open the **Settings** menu.
- 2 Select **Preferences** and press **OK**.
> *The Preferences menu shows.*

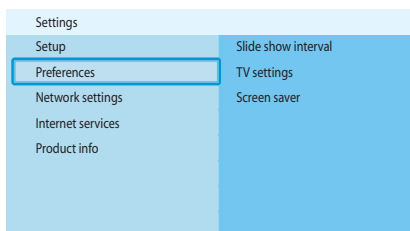

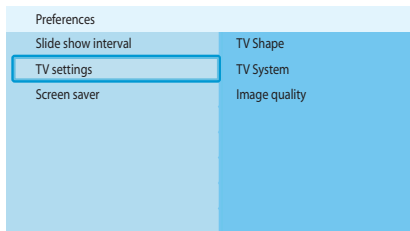

- Select **TV settings** and press **OK**.
> *The TV settings menu shows.*

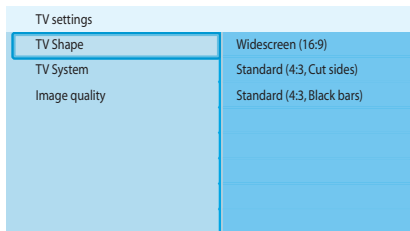

- Select **TV Shape** and press **OK**.
> *The TV shape menu shows.*

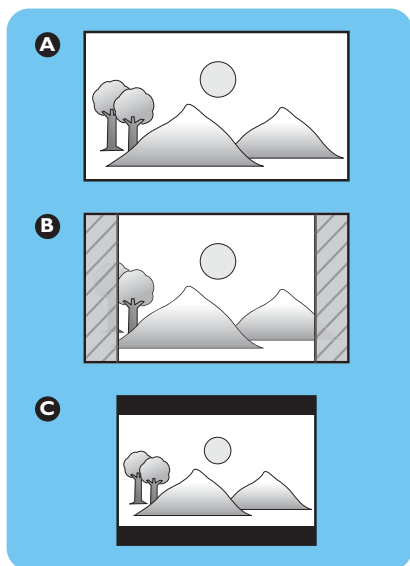

- Select the preferred item and press **OK**.

Item	Description
Widescreen (16:9)	The TV shape is 16:9 (widescreen). Refer to A.
Standard (4:3, Cut sides)	The TV shape is 4:3. The left and right parts of widescreen images do not show. Refer to B.
Standard (4:3, Black bars)	The TV shape is 4:3. The top and bottom parts of widescreen images show black bars. Refer to C.

Change the TV system

- Open the **Settings** menu.
- Select **Preferences** and press **OK**.
> *The Preferences menu shows.*

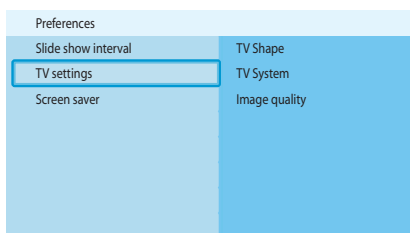
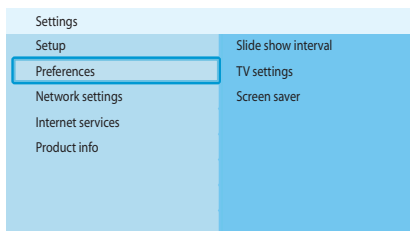

- Select **TV settings** and press **OK**.
> *The TV settings menu shows.*

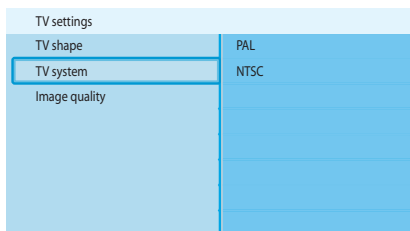

- 4 Select **TV System** and press **OK**.
> *The TV system menu shows.*
- 5 Select the preferred item and press **OK**.

Item	Description
PAL	Sets the TV system of the product to PAL (European standard).
NTSC	Sets the TV system of the product to NTSC (American standard).

Change the image quality

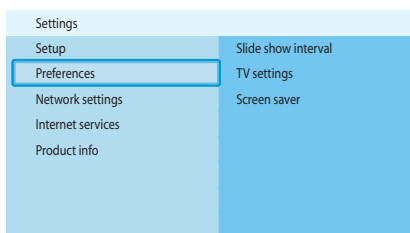

- 1 Open the **Settings** menu.
- 2 Select **Preferences** and press **OK**.
> *The Preferences menu shows.*

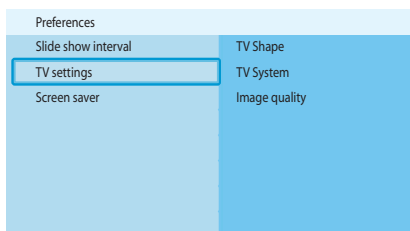

- 3 Select **TV settings** and press **OK**.
> *The TV settings menu shows.*



- 4 Select **Image quality** and press **OK**.
> *The Image quality menu shows.*
- 5 Select the preferred item and press **OK**.

PAL, TV connected to SCART port

Item	Description
Standard-definition (576i)	Standard-definition (576 lines, interlaced @ 50 Hz)
Enhanced-definition (576p)	Not available
High-definition (720p)	Not available
High-definition (1080i)	Not available

PAL, TV connected to component video port

Item	Description
Standard-definition (576i)	Standard-definition (576 lines, interlaced @ 50 Hz)
Enhanced-definition (576p)	Enhanced-definition (576 lines, progressive scan @ 50 Hz)
High-definition (720p)	High-definition (720 lines, progressive scan @ 50 Hz)
High-definition (1080i)	High-definition (1080 lines, interlaced @ 50 Hz)

NTSC, TV connected to SCART port

Item	Description
Standard-definition (480i)	Standard-definition (480 lines, interlaced @ 60 Hz)
Enhanced-definition (480p)	Not available
High-definition (720p)	Not available
High-definition (1080i)	Not available

NTSC, TV connected to component video port

Item	Description
Standard-definition (480i)	Standard-definition (480 lines, interlaced @ 60 Hz)
Enhanced-definition (480p)	Enhanced-definition (480 lines, progressive scan @ 60 Hz)
High-definition (720p)	High-definition (720 lines, progressive scan @ 60 Hz)
High-definition (1080i)	High-definition (1080 lines, interlaced @ 60 Hz)

Enable the screen saver

- 1 Open the **Settings** menu.
- 2 Select **Preferences** and press **OK**.
> *The Preferences menu shows.*

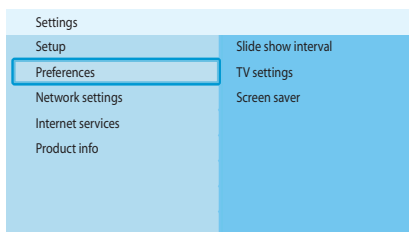

- 3 Select **Screen saver** and press **OK**.
> *The Screen saver menu shows.*
- 4 Select the preferred item and press **OK**.

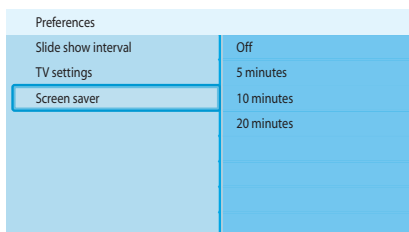

Item	Description
Off	The screen saver does never start
5 minutes	The screen saver starts after 5 minutes
10 minutes	The screen saver starts after 10 minutes
20 minutes	The screen saver starts after 20 minutes

View the device name

- 1 Open the **Settings** menu.
- 2 Select **Network settings** and press **OK**.
> *The Network settings menu shows.*

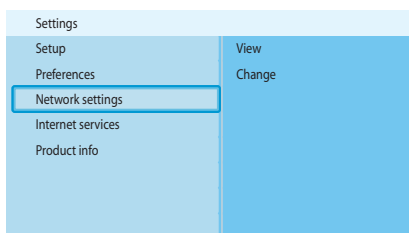

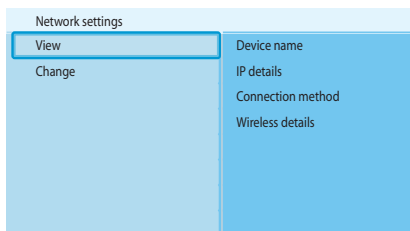

- 3 Select **View** and press **OK**.
> *The **View** menu shows.*
- 4 Select **Device name** and press **OK**.
> *The device name shows.*

View the IP details

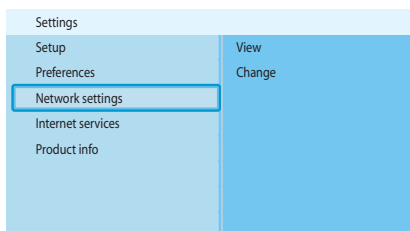

- 1 Open the **Settings** menu.
- 2 Select **Network settings** and press **OK**.
> *The **Network settings** menu shows.*

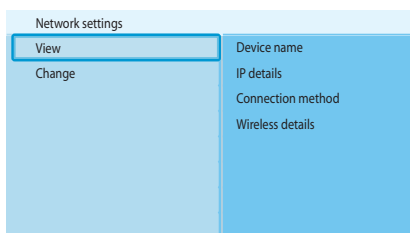

- 3 Select **View** and press **OK**.
> *The **View** menu shows*
- 4 Select **IP details** and press **OK**.
> *The IP details show.*

Item	Description
Assignment	DHCP or Static IP
IP Address	IP address
NetMask	Network mask
Gateway	Gateway
Primary DNS	Primary domain name server
Secondary DNS	Secondary domain name server

View the connection method

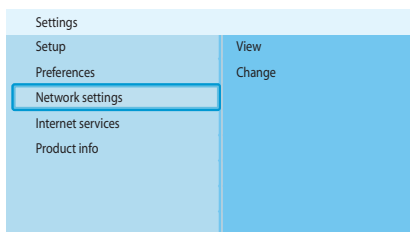

- 1 Open the **Settings** menu.
- 2 Select **Network settings** and press **OK**.
> *The **Network settings** menu shows.*

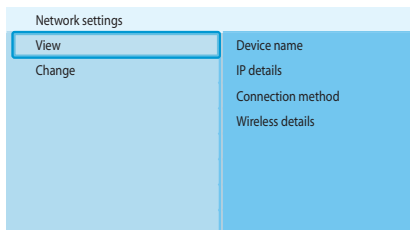

- 3 Select **View** and press **OK**.
> *The **View** menu shows*
- 4 Select **Connection method** and press **OK**.
> *The connection method shows.*

Item	Description
Current connection method	Wired or Wireless
MAC address wired	MAC address of the wired network connection.
MAC address wireless	MAC address of the wireless network connection.

View the wireless details

- 1 Open the **Settings** menu.
- 2 Select **Network settings** and press **OK**.
> *The **Network settings** menu shows.*
- 3 Select **View** and press **OK**.
> *The **View** menu shows.*
- 4 Select **Wireless details** and press **OK**.
> *The wireless details show.*

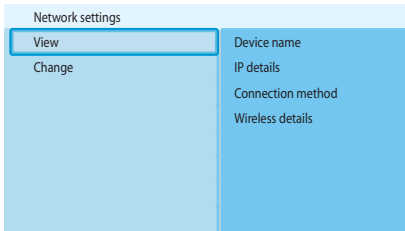
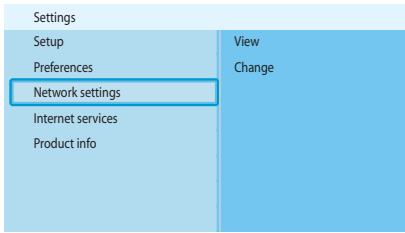

Item	Description
Connection status	Status of the wireless network connection
Signal strength	Signal strength (%)
Network name	Network name
Wireless mode	Infrastructure or Ad-hoc
Channel	Channel number
Encryption type	Off, WEP or WPA

Change the device name

Tip You can use the device name to tell two or more products apart on the same network.

- 1 Open the **Settings** menu.
- 2 Select **Network settings** and press **OK**.
> *The **Network settings** menu shows.*
- 3 Select **Change** and press **OK**.
> *The **Change** menu shows.*
- 4 Select **Device name** and press **OK**.
> *The device name shows.*

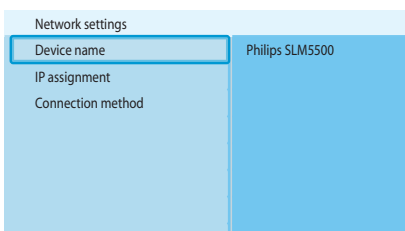
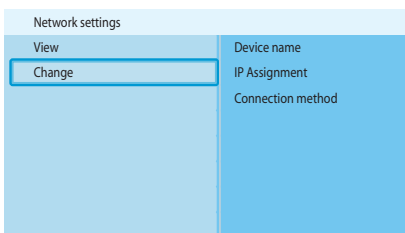
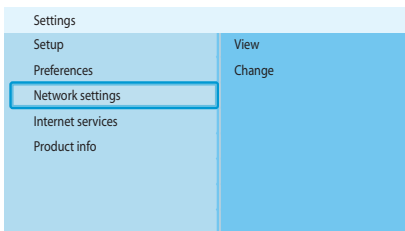

The default name is **Philips SLM5500**.

- 5 Change the device name and press **OK**.

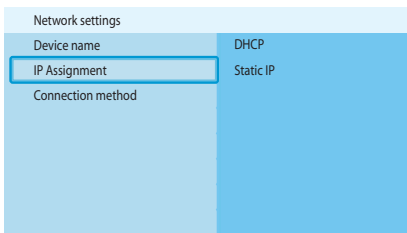
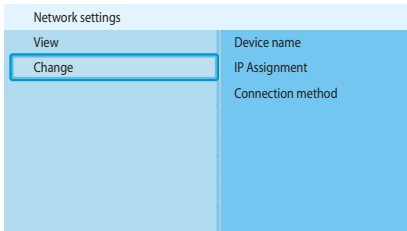
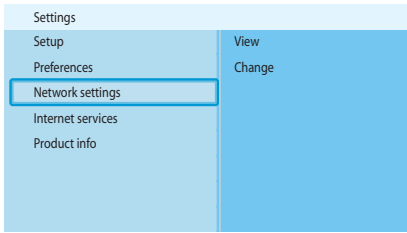

Change the IP assignment

- 1 Open the **Settings** menu.
- 2 Select **Network settings** and press **OK**.
> *The **Network settings** menu shows.*

- 3 Select **Change** and press **OK**.
> *The **Change** menu shows.*

- 4 Select **IP Assignment** and press **OK**.
> *The **IP Assignment** menu shows.*

- 5 Select the preferred item and press **OK**.
> *A wizard starts.*

Item	Description
DHCP	The base station or router gives an IP address to the product.
Static IP	You give the product a static IP address. (Only for advanced users.)

- 6 Make sure that you have the correct data.

Static IP

Data	From
IP address	Valid range of IP addresses
Network mask	Base station or router
Gateway	Base station or router
DNS primary	Internet service provider

- 7 Follow the on-screen instructions.

Change the connection method

- 1 Open the **Settings** menu.
- 2 Select **Network settings** and press **OK**.
> *The **Network settings** menu shows.*

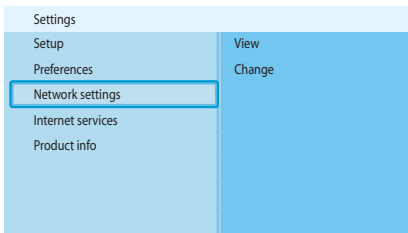

- 3 Select **Change** and press **OK**.
> *The **Change** menu shows.*

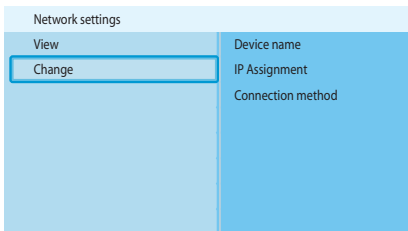

- 4 Select **Connection method** and press **OK**.
> *The **Connection method** menu shows.*
- 5 Select the preferred item and press **OK**.

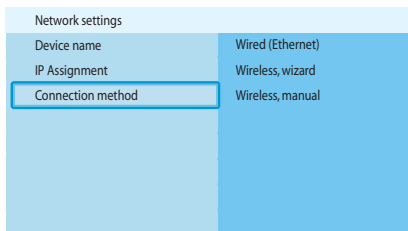

Item	Description
Wired, Ethernet	Connection to a wired Ethernet network.
Wireless, wizard	Automatic connection to a wireless network with a wizard.
Wireless, manual	Manual connection to a wireless network (only for advanced users).

- 6 Make sure that you have the correct data.

Wireless, wizard

Data	From
Network name (SSID)	Base station or router
Encryption type	Base station or router

Wireless, manual

Data	From
Network name (SSID)	Base station or router
Infrastructure	Wireless network
Encryption type	Base station or router

- 7 Follow the on-screen instructions.

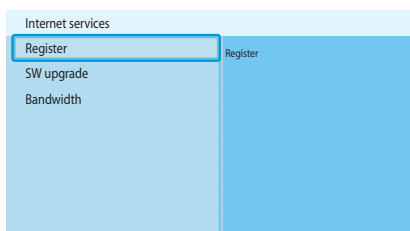
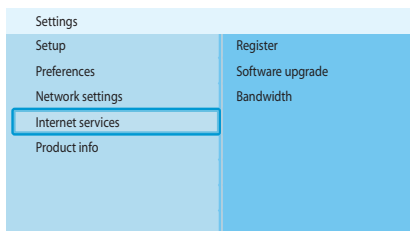

Register for Internet services

- 1 Open the **Settings** menu.
- 2 Select **Internet services** and press **OK**.
> *The **Internet services** menu shows.*
- 3 Select **Register** and press **OK**.
> *A wizard starts.*
- 4 Enter your e-mail address so that Club Philips can send a registration e-mail to your computer.
- 5 Follow the instructions in the e-mail.

Upgrade the software

CAUTION Do not turn the product off during a software upgrade.

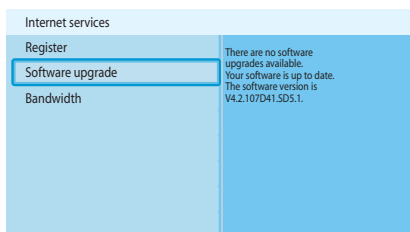
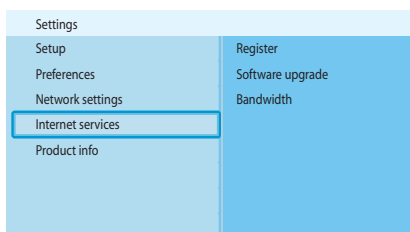

- 1 Open the **Settings** menu.
- 2 Select **Internet services** and press **OK**.
> *The **Internet services** menu shows.*
- 3 Select **Software upgrade** and press **OK**.
> *A wizard starts.*
- 4 Follow the on-screen instructions.

Set the bandwidth for Internet media files

The product can automatically select a specific Internet media file when an Internet media file is available in multiple sizes. For example, if you have an Internet connection with a high bandwidth, the product can automatically select for movies with a high resolution.

Some Internet service providers charge extra fees for exceeding a certain limit of transferred data.

- 1 Open the **Settings** menu.

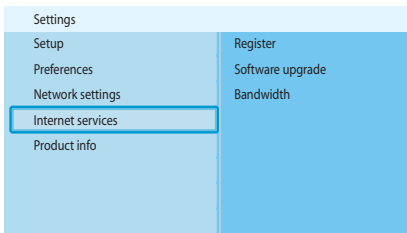

- 2 Select **Internet services** and press **OK**.
 > *The **Internet services** menu shows.*

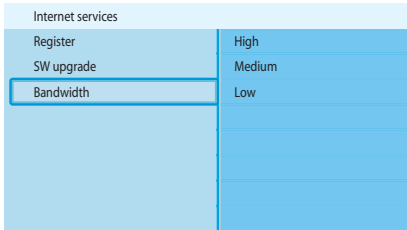

- 3 Select **Bandwidth** and press **OK**.
- 4 Select the preferred item and press **OK**.

Tip When you cannot play Internet media files, select a lower bandwidth.

Item	Description
High	High bandwidth
Medium	Medium bandwidth
Low	Low bandwidth

View the product information

- 1 Open the **Settings** menu.
- 2 Select **Product info** and press **OK**.
 > *The **product information** shows.*

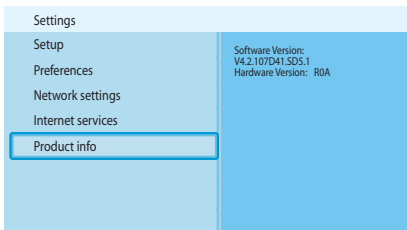

Troubleshooting

Problems and tips

Problem	Tip
No reaction to the supplied remote control	<p>Connect the power adapter to the power supply.</p> <p>Point the remote control at the product.</p> <p>Insert the batteries correctly.</p> <p>Insert new batteries in the remote control.</p>
No video signal on the TV screen	<p>Turn the TV on.</p> <p>Set the TV to the correct external input</p> <p>Set the To TV switch on the rear of the product to the correct position and restart the product.</p> <p>Make sure that the TV supports the video signal of the product. Press the green button on the supplied remote control for 3 seconds to restore the video signal to the factory default values.</p>
No sound signal from the loudspeakers of the audio system	<p>Turn the audio system on.</p> <p>Set the audio system to the correct external input.</p> <p>Increase the volume level of the audio system.</p>
Cannot find the wired network	<p>Turn the other wired network devices on.</p> <p>Use a straight network cable (Ethernet, UTP 5e) to make a connection from the product to the wired network.</p>
Cannot find the wireless network	<p>Turn the other wireless network devices on.</p> <p>Decrease the distance between the base station or router and the product.</p> <p>Either - make sure that the broadcast wireless network name (SSID Broadcast) is enabled on the base station or router</p> <p>Or - enter the network name (SSID) manually. Copy the network name from the base station or router.</p>
Cannot connect to the wireless network	<p>Enter the correct security code (WEP or WPA). Copy the security code (WEP or WPA) from the base station or router</p> <p>Make sure that the firewalls in the wireless network give the product access to the wireless network. For example, allow or unblock the MAC address of the product on the network.</p> <p>Make sure that the wireless network uses the first security code of the base station or router.</p>
No access to media files (movies, music or pictures)	<p>Start the Philips Media Manager.</p> <p>Make sure that the Philips Media Manager shares media files with the product.</p> <p>Connect the product to the correct network.</p> <p>Make sure that the firewalls in the computer and base station or router give the Philips Media Manager access to the network. For example, allow or unblock the Philips Media Manager.</p>
Cannot play a media file	<p>Make sure that the product supports the file format (refer to page 35).</p> <p>Make sure that the Philips Media Manager shares the media file with the product.</p> <p>When you play a protected media file (WMA-DRM, WMV-DRM) for the first time, the product must have a connection to the Internet.</p>
Cannot play Internet media files	<p>Try again later. The Internet service can be down temporarily.</p> <p>Make sure that the product supports the Internet format</p> <p>Make sure that the firewalls in the network give the Internet service access to the network.</p>

Video playback

Compression formats	DivX 3.11, DivX 4, DivX 5, MPEG 1, MPEG2, MPEG4, XviD, WMV, WMV-DRM HD-MPEG2 (on wired network)
---------------------	--

Audio playback

Compression formats	MP3, PCM, WAV, WMA-DRM, WMA, AAC-MPEG4
ID3-tag support	

Still picture playback

Picture compression format	JPEG
Picture enhancement	Slideshow with audio playback, High Definition Resolution
Thumbnail view	

Connectivity

Encryption/security	WEP 128 bit, WEP 64 bit, WPA
LAN wired	Ethernet (on RJ 45) 1 x
Video output - Analog	Audio L + R (on SCART), Component RGB (on SCART), Composite CVBS (on SCART), Component Y Pb Pr (on cinch)
Wireless connections	Wireless LAN (802.11b/g)
Audio output - Digital	Coaxial SP/DIF (on cinch)

Software

Philips Media Manager	UPnP multimedia content server
-----------------------	--------------------------------

System requirements

CD-ROM drive	
Hard disk space	100 MB
PC OS	Windows® 98SE, Windows® 2000, Windows® ME, Windows® XP
Processor	Pentium II or better
RAM memory	64 MB
PC network required	Wireless or wired PC network
Internet connection	Broadband Internet (> 256 kbps)
Club Philips	Internet access and e-mail

Dimensions

Product dimensions (WxDxH)	207 x 152 x 40 mm
Product weight	0.84 kg

Power

Mains power	AC 100-240 V 50-60 Hz
On/Off switch	
Power consumption	15 W (2.5 W stand-by)
Power LED indicator	Blue, red

Internet services

Refer to Club Philips for the latest list of Internet services.

Audio services	Live 365.com, Andante, Radio Free Virgin, Playhouse radio, ... and more
Video services	Yahoo! Movies, Launch, iFILM
Photo services	Yahoo! Photos
My media	Add your own Internet streams



Be responsible
Respect copyrights

Respect copyrights

The making of unauthorised copies of copy-protected material, including computer programmes, files, broadcasts and sound recordings, may be an infringement of copyrights and constitute a criminal offence. This equipment should not be used for such purposes.

Disclaimer

This product is protected by certain intellectual property rights of Microsoft Corporation. Use or distribution of such technology outside of this product is prohibited without a license from Microsoft or an authorized Microsoft subsidiary. Content providers are using the digital rights management technology for Windows Media contained in this device ("WM-DRM") to protect the integrity of their content ("Secure Content") so that their intellectual property, including copyright, in such content is not misappropriated. This device uses WM-DRM software to play Secure Content ("WM-DRM Software"). If the security of the WM-DRM Software in this device has been compromised, Microsoft may revoke (either on its own or upon the request of the owners of Secure Content ("Secure Content Owners")) the WM-DRM Software's right to acquire new licenses to copy, display and/or play Secure Content. Revocation may also prevent your device's ability to transfer, store, copy, display and/or play Secure Content which you have previously stored on your Device. Revocation does not alter the WM-DRM Software's ability to play unprotected content. A list of revoked WM-DRM Software is sent to your device whenever you download a license for Secure Content from the Internet or from a PC. Microsoft may, in conjunction with such license, also download revocation lists onto your device on behalf of Secure Content Owners, which may disable your device's ability to copy, display and/or play Secure Content.

In the event of revocation, Philips will attempt to make available software updates to restore some or all of your device's ability to transfer, store, access, copy, display and/or play Secure Content. However, the ability to make such updates available does not rest solely with Philips. Philips does not guarantee that, after revocation, such software updates will be available. If such updates are not available, your device will not have the ability to transfer, store, copy, display and/or play Secure Content - even Secure Content which you have previously stored on your device.

In addition, even if such software updates are available, they may not enable your Device to transfer, store, copy, display, and/or play Secure Content which was previously stored on your Device. In some cases you may be able to transfer the content from the PC. In other cases, you may have to repurchase previously obtained Secure Content.

To summarize - Microsoft, Secure Content Owners, and Secure Content distributors may deny you access, or restrict your access, to Secure Content. They may also disable your device's ability to transfer, store, copy, display and/or play Secure Content even after you have paid for and obtained it. Neither your consent nor the consent or approval of Philips is necessary for any of them to deny, withhold or otherwise restrict your access to Secure Content or to disable your device's ability to transfer, store, access, copy, display, and/or play Secure Content. Philips does not guaranty that you will be able to transfer, store, access, copy, display, and/or play Secure Content.

Trademarks

Windows is a registered trademark of Microsoft Corporation in the United States and other countries.

CE 0682 ⓘ

Wireless transmission

The product transmits and receives radio waves when it is switched on. The product complies with the standards that are defined for it. The quality of the image can be influenced by the use of microwave ovens. Other wireless systems (Bluetooth, wireless networks etc.) can also have influence on the quality of the image.

Health and safety

Philips Royal Electronics manufactures and sells many products targeted at consumers, which, like any electronic apparatus, in general have the ability to emit and receive electro magnetic signals. One of Philips' leading Business Principles is to take all necessary health and safety measures for our products, to comply with all applicable legal requirements and to stay well within the EMF standards applicable at the time of producing the products. Philips is committed to develop, produce and market products that cause no adverse health effects. Philips confirms that if its products are handled properly for their intended use, they are safe to use according to scientific evidence available today. Philips plays an active role in the development of international EMF and safety standards, enabling Philips to anticipate further developments in standardization for early integration in its products.

Maintenance and service

If the product is defective and needs repair, but the warranty period has expired, you can consult our specialists (refer to page 9).

Disposal of your old product



Your product is designed and manufactured with high quality materials and components, which can be recycled and reused. When this crossed-out wheeled bin symbol is attached to a product it means the product is covered by the European Directive 2002/96/EC. Please inform yourself about the local separate collection system for electrical and electronic products. Please act according to your local rules and do not dispose of your old products with your normal household waste. The correct disposal of your old product will help prevent potential negative consequences for the environment and human health.

Warranty

Refer to the installation CD for a guarantee leaflet.

Terms and definitions

Ad-hoc network	A direct connection between two devices. For example, a connection between a computer and the product.
Codec	Coder-decoder. A program that can decode a signal into music or a movie (for example, MP3 or DivX).
Component video	A type of analog video information.
DHCP	Dynamic Host Configuration Protocol. The DHCP gives IP addresses to the computer network devices.
DNS	Domain Name Server. A server that changes the names of domains (for example, www.philips.com) in IP addresses.
DRM	Digital Rights Management. DRM protects the integrity of the media file so that the intellectual property, including copyright, in such media file is not misappropriated.
Firewall	A program or computer network device that makes sure that the computer network is secure.
Gateway	An IP address that a computer network uses to get access to the another computer network. For example, the IP address that a local area network uses to get access to the Internet.
Infrastructure network	A computer network of two or more devices that are connected through a central host (for example, a base station or a router).
IP address	A unique combination of four numbers (0 - 255) that identifies a device in a computer network. An IP address can be static or dynamic (given by a DHCP).
MAC address	A unique combination of 6 hexadecimal numbers (00 - FF) that identifies (a part of) a physical device.
Network mask	A combination of four numbers (0 - 255) that identifies the maximum number of IP addresses in a computer network. For example, when the network mask is 255.255.255.0, the first, second and third numbers of all IP addresses in the computer network are the same.
NTSC	National Television System Committee. A type of analog TV system. NTSC is mostly used in the Americas.
PAL	Phase-alternating line. A type of analog TV system.
Philips Media Manager	The program that can share the media files on a computer with the product.
SSID	Service Set Identifier. The name of the wireless computer network.
Streamium	The Philips range of Internet-enabled products.
UPnP	Universal plug-and-play. A method to share media files in a home network.
WEP	Wired Equivalent Privacy. A security type for wireless computer networks.
WPA	WiFi-protected Access. A security type for wireless computer networks.

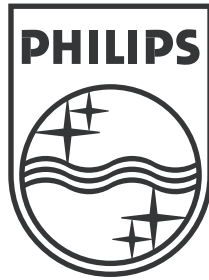

Specifications are subject to change without notice.
Trademarks are the property of Koninklijke Philips Electronics N.V. or their respective owners.
2006 © Koninklijke Philips Electronics N.V. All rights reserved.

www.philips.com

3 122 337 03402