

Wall mounting instructions

Drill holes on wall at hole positions marked (no accessories provided with this template)

EN

What's in the supplied mounting kit

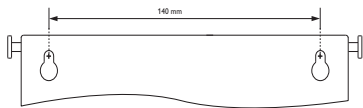

1 x wall mount template

What else you'll need

- Electric drill
- 2 x screws and dowels
- Screwdriver
- Pencil

Mount the main unit

! Caution

- To find a suitable mounting location, make the necessary physical and wireless connections.
- Mount the main unit and speakers to a solid concrete wall or plaster board wall only!

You can use the supplied bracket to mount the main unit and speakers to the wall.

- 1 Align the template in the chosen location on a wall. Use a pencil to mark the drilling positions.

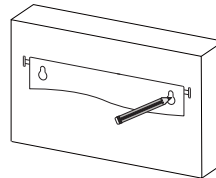

- 2 Drill holes as marked.

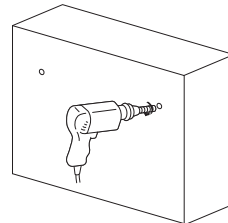

- 3 Secure 2 supplied screws in the holes, but leave 5mm between the screw head and the wall.

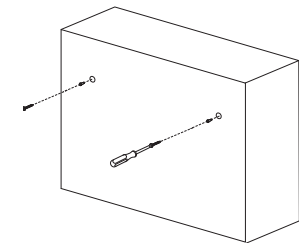

- 4 Detach the table stand from the main unit.

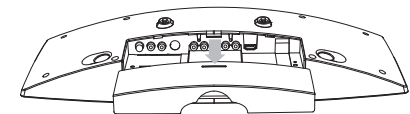

- 5 Hook the main unit in place.

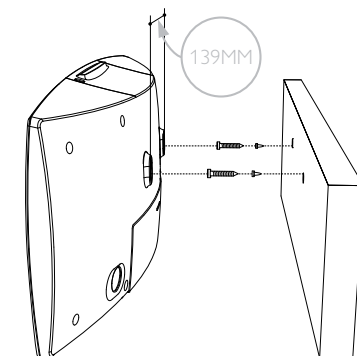

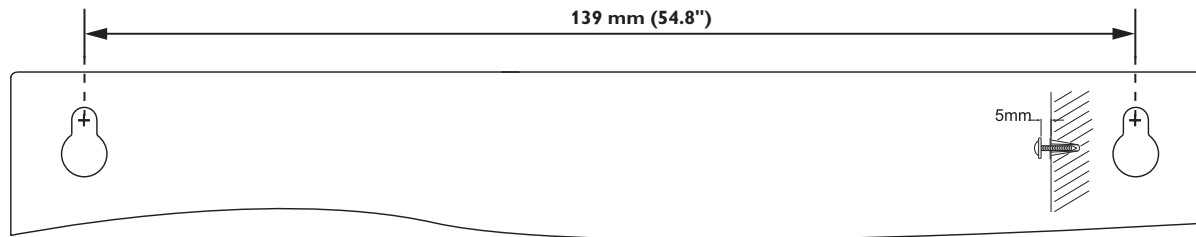

壁掛安裝指示

已此墊紙為樣本在牆上鑽洞（未隨附任何樣本配件）。

ZH-TW

安裝套件隨附物品：

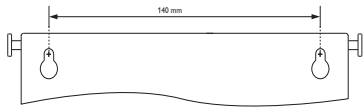

1 個壁掛板

您還需要

- 電鑽
- 2 個螺絲和暗榫
- 螺絲起子
- 鉛筆

掛置主裝置

! 注意

- 找到合適的架設位置，並完成必要的實體連線和無線連線。
- 掛置主裝置和揚聲器的牆面必須為堅固的混凝土牆或石膏板牆！

您可使用隨附的支架將主裝置與揚聲器固定到牆上。

1 將壁掛板對準牆上選定的安裝位置。用鉛筆標記鑽孔位置。

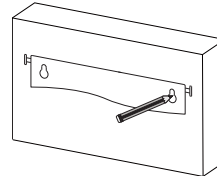

2 在標記的位置上鑽孔。

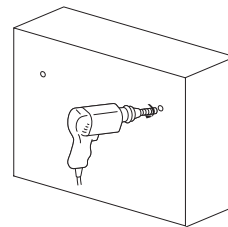

3 將 2 顆隨附的螺絲鎖入孔中，螺絲頭與牆面之間保留 5 公釐間隙。

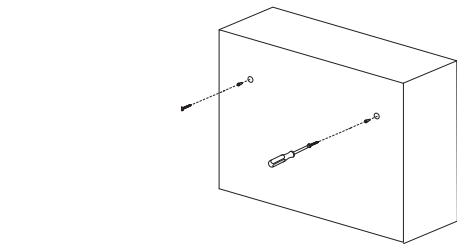

4 主裝置的桌面腳架拆下。

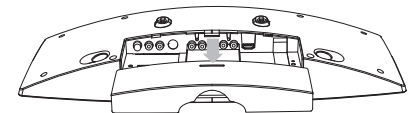

5 將主裝置掛到牆上。

