

.....	54
.....	54
.....	54
.....	54
.....	54
.....	55
.....	56-58
.....	58
.....	59-62
.....	59
.....	60
VIDEO	60
.....	60
.....	61
FM AMMW	62
.....	62
.....	63
.....	63
/	63
.....	64-68
.....	64
.....	64
.....	65
DVD (OSD)	65
.....	65-66
.....	66
.....	67
.....	68
.....	69-77
.....	69
.....	69
.....	70
/	70
.....	71
(DVD/VCD/SVCD)	71-74
.....	71
.....	72
/	72
.....	72
.....	72
.....	72
.....	73
.....	73
VCD	73
VCD/SVCD	74

MP3/WMA	75
JPEG	76
.....	76
.....	76
/	76
MP3/WMA JPEG	77
DivX	77
<hr/>	
USB	78
USB USB	78
-	79
.....	79
- OK	80
OK	80
<hr/>	
.....	81-86
.....	81
.....	82
.....	83
.....	84
.....	85-86
<hr/>	
.....	87-88
.....	87
.....	87
.....	87-88
.....	87
.....	88
.....	88
.....	88
.....	88
<hr/>	
.....	89
.....	89
.....	89
.....	89
.....	90
.....	90
.....	91-93
(USB)	94
.....	95
.....	96-97

=====

-

-

-

CD

-

-

10 4
 5 2

-

-

=====

- 1

- 2

- 2

- 1

- 1

- 1

- 1 FM

- 1 AMMV

- 1 MP3

- 1

-

=====

=====

=====

=====

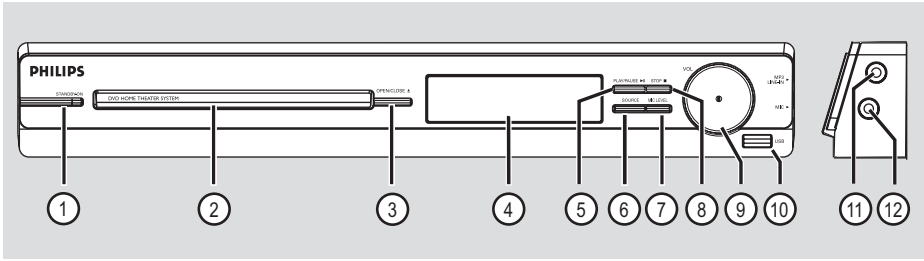

中文(简体)

① **STANDBY-ON**

-

②

③ **OPEN/CLOSE ▲**

- /

④

⑤ **PLAY/PAUSE** **u** (/)

- DISC () /

- RADIO ()

⑥ **SOURCE** ()

-

DISC FM AMMW TV ALX MP3
LINE-IN

⑦ **MIC LEVEL**

-

⑧ **STOP** **■** ()

-

-

-

⑨ **VOL**

-

⑩ **USB**

- USB USB

⑪ **MP3 LINE-IN**

-

⑫ **MIC**

-

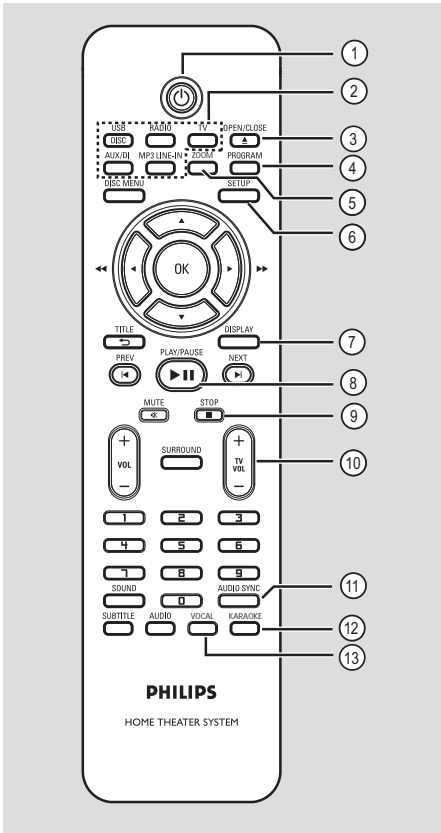

③ OPEN/CLOSE ▲

- /

④ PROGRAM

-

⑤ ZOOM

-

⑥ SETUP

-

⑦ DISPLAY

-

DVD

⑧ PLAY/PAUSE u

- /

⑨ STOP ■

-

⑩ TV VOL +/-

-

⑪ AUDIO SYNC

-

⑫ KARAOKE

-

⑬ VOCAL

-

① ①

-

②

- DI SC/USB DI SC USB

RADI O FM AM/MV

TV

AUX/DI AUDIO IN

AUX

MP3 LINE-IN

MP3 LINE-IN

⑭ **DISC MENU**

- DVD
- VCD/SVCD

⑮ **OK**

-

⑯ **v V b B**

-

-

-

-

-

⑰ **TITLE C**

- DVD
- VCD 2 0

⑱ **PREV ◀ / NEXT ▶**

-

-

-

⑲ **MUTE %**

-

⑳ **VOL + / -**

-

㉑ **SURROUND**

-

㉒ **0-9**

-

-

㉓ **SOUND**

-

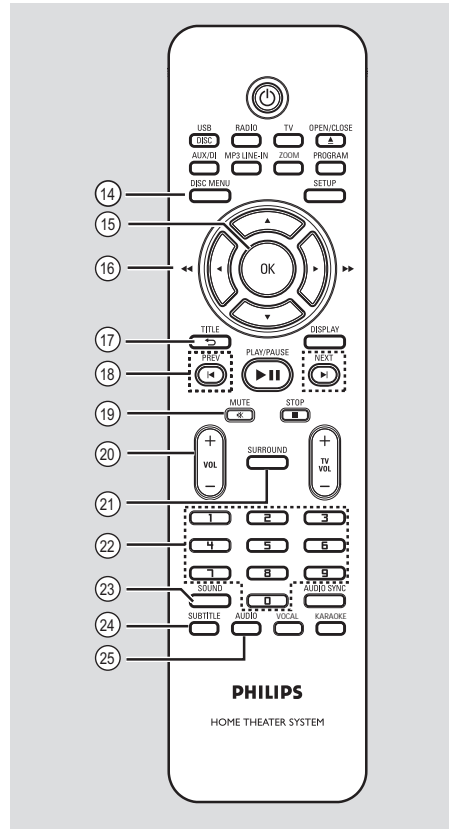

中文(简体)

㉔ **SUBTITLE**

- DVD

㉕ **AUDIO**

-

/

()

中文(简体)

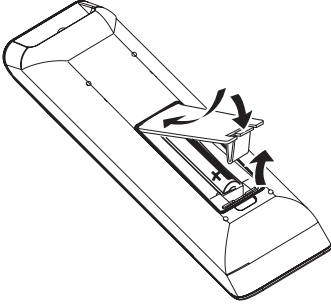

①

②

(+ -)
R03 AAA

③

④

⑤

DISC/USB
RADIO TV AUX/CD MP3 LINE-IN

⑥

(◀ ▶)

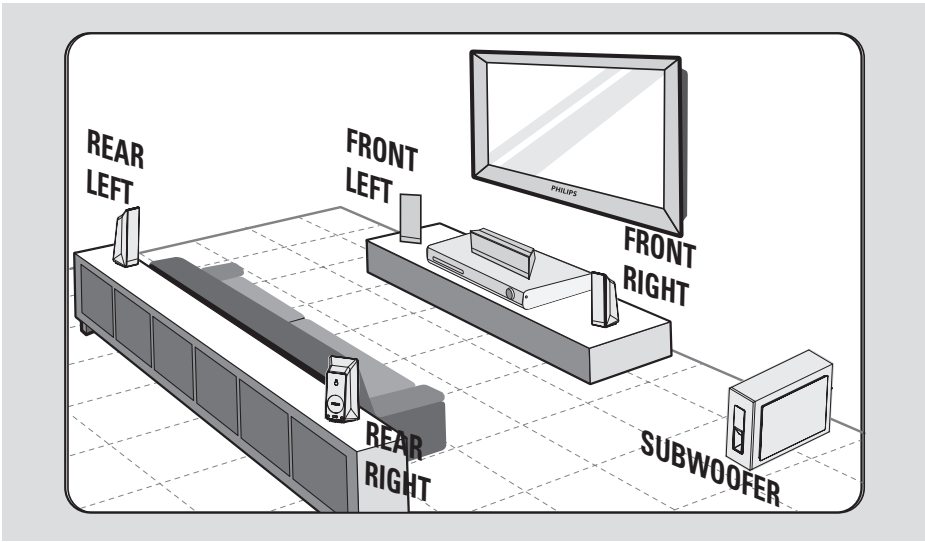

①

45

②

③

④

REAR LEFT
REAR RIGHT

FRONT LEFT
FRONT RIGHT

“

()

中文(简体)

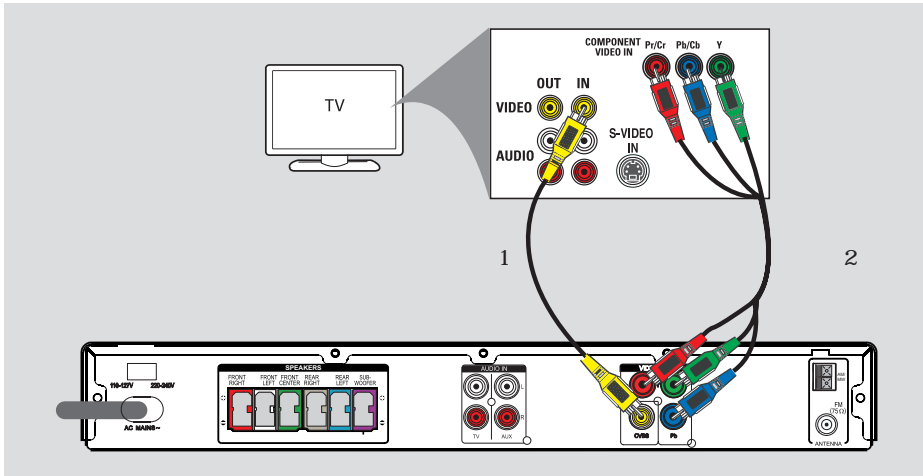

VIDEO

CVBS

A/V In Video In Composite Baseband

è

Y Pb Pr

Y Pb Pr

DVI

AUDIO IN
AUDIO

TV

①

/ /
Y Pb Pr

Y Pb/Cb Pr/Cr

YUV

②

“

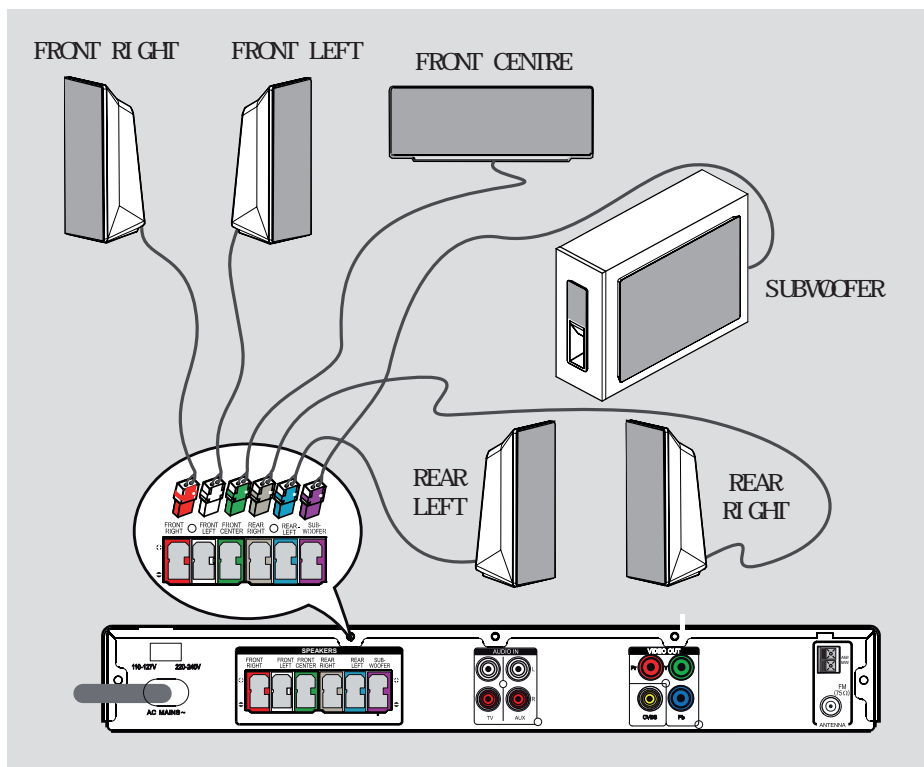

中文(简体)

()

中文(简体)

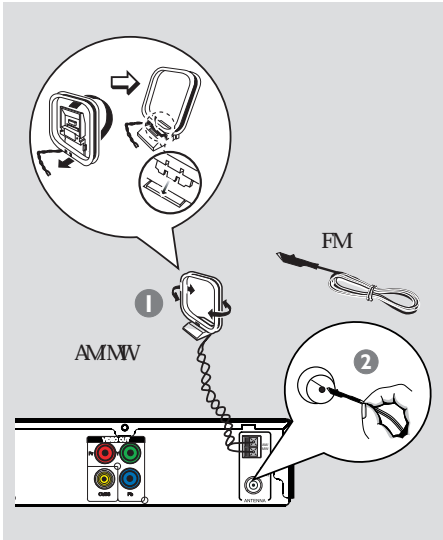

FM AMMW

1 AMMW AMMW AMMW

2 FM FM FM 75 Ω

FM
FM

VCR

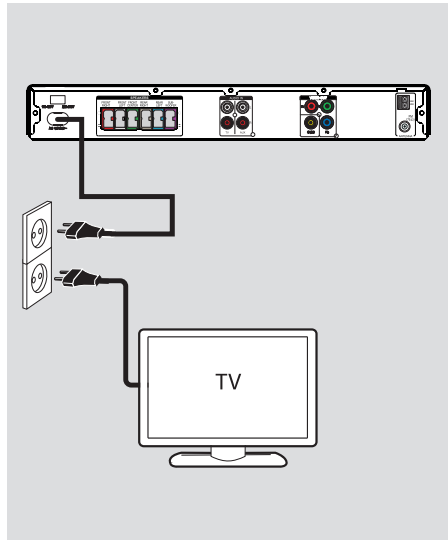

1

110-127V 220-240V

2

è

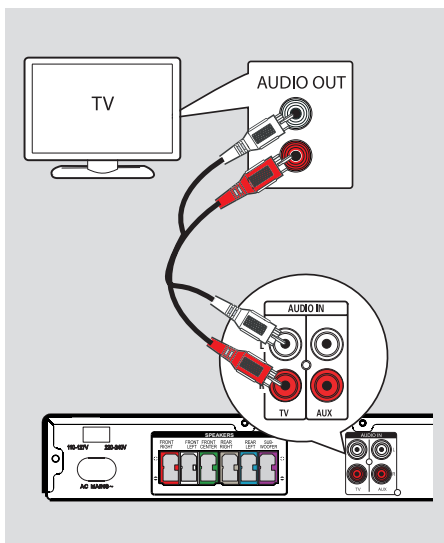

AUDIO IN-TV
AUDIO OUT

TV

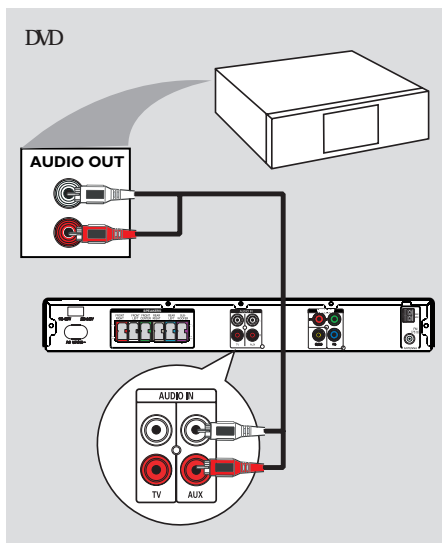

DVD

AUDIO IN-AUX
AUDIO OUT

AUX/DI

中文(简体)

1 SOURCE
 " DISC
 DISC/USB

2
 " Channel

Down

FRONT A/V IN

VIDEO

SOURCE

DISC → FM → AMMW → TV
 → AUX → MP3 LINE-IN MP3
 → DISC

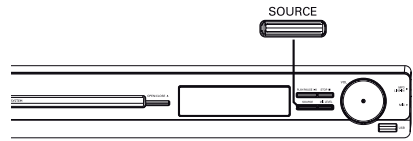

DISC/USB RADIO
 TV AUX/DI MP3 LINE-IN
 è DISC/USB DISC USB
 è RADIO FM AMMW
 è
 TV
 è AUX/DI
 AUDIO IN AUX
 è MP3 LINE-IN
 MP3

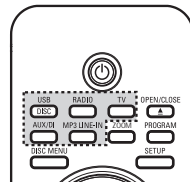



DVD

DVD



OSD

DVD

1

SETUP

è { }

2

e { i }



3

d e
OK

1

>
SETUP

2

i { }

3

d e
i

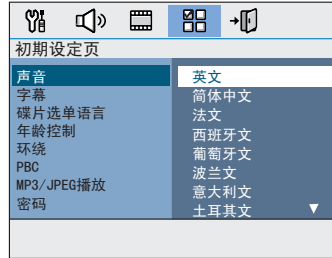

{
DVD }

{
DVD }

{
DVD }

4

d e
OK

中文(简体)

()

{ }
0-9 4
“ XXXX 4
OK

中文(简体)

5

3 ~ 4

- DVD
AUDIO SUBTITLE

- DVD / /
DVD

1

SETUP

2

i { }

3

e { }
i

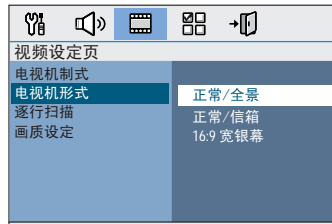

{ ___ / ___ }



{ / }



{ 16:9 }



4

OK



6

OK

OK

... Y Pb Pr "

2

7

è

8

OK

OK

è

1

è

1 OPEN/CLOSE ▲

2

DI SC/USB

2

h

3

SETUP

3

AUDI O

4

i { }

-

15

5

{ } { } >
{ } OK

-

DVD

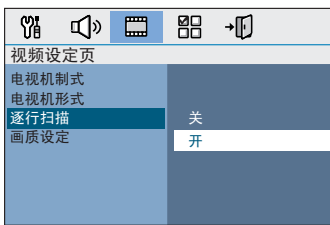

中文(简体)

()

中文(简体)

STOP

1 SETUP

2 i { }

3 e { }

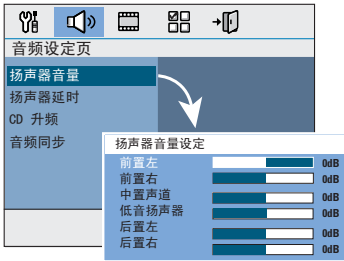

4 h i (-6dB ~ +6dB) OK

5 d e { } i

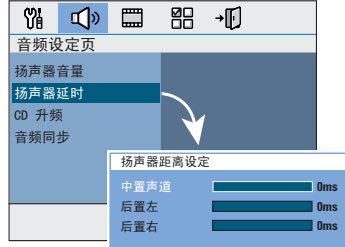

6 h i (0 ms ~ 15 ms)

7 OK

- 1 / 30 /
-
-



- DVD
- (DVD)
- (VCD)
- (SVCD)
- DVD (DVD±R)
- DVD (DVD±RW)
- (CD)
- MP3/ Windows Media CD-R(W) (Kodak, JPEG)
- ISO9660/UDF
- JPEG 3072 x 2048
- 32 44.1 48
- 32~256 (kbps) (128 kbps)
- CD-R(W)/DVD±R(W) DivX
- DivX 3/4/5/6 DivX Ultra

DVD
DVD

0 X

- 1 SOURCE " DI SC DI SC/
- USB
- 2
- è DVD
- 3 OPEN/CLOSE ▲
- 4 OPEN/CLOSE ▲
- è
- 5 è

中文(简体)

()

中文(简体)



u
 /
 0-9
 /
 m /M
 m /M
 u
 x
 -
 [PREV]
 -
 15

DVD/SVCD/VCD
 ① DI SPLAY
 ② e
 ③ i
 DI SPLAY

DVD
 " RPT ONE
 " RPT TT
 " SHUFFLE
 " RPT SHF
 " RPT OFF

VCD/SVCD/CD
 " RPT ONE
 " RPT ALL
 " SHUFFLE
 " RPT SHF
 " RPT OFF

MP3/DivX/Windows Media™
 " RPT ONE
 " RPT ALL/FLD
 " SHUFFLE
 " RPT OFF

()

(DVD/VCD/SVCD)

Picture CD/MP3

①
è

PROGRAM

编程: 曲目 (01-16)			
1	04	6	--
2	10	7	--
3	12	8	--
4	--	9	--
5	--	10	--
退出 开始 后页 ▶			

②

0-9

②

hide

{ } OK
▶

/ OK

④

OK

{ }

0-9

hide

OK

⑤

{ } OK

DISC MENU

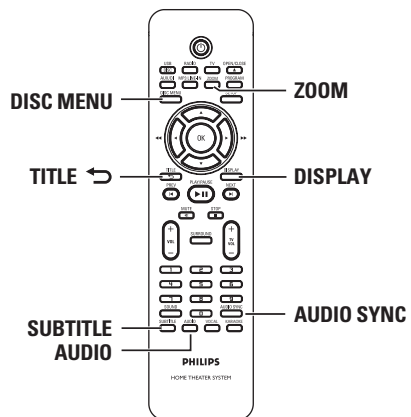

中文(简体)

()

中文(简体)

①

è

DI SPLAY

DVD

菜单	▶
标题	01/01
章节	02/99
声音	2ch 中
字幕	关 ▼
位率	播放时间 0:29:17

VCD/SVCD

菜单	▶
曲目	09/16
全碟时间	1:16:05
曲目时间	0:04:32
重复播放	关 ▼
位率 8	全碟时间 0:29:17

②

d e

CK

③

d e

0-9

/

④

CK

è

/

①

ZOOM

è

②

h i d e

③

ZOOM



DVD

DVD

/

SUBTI TLE



DVD

①

DI SPLAY

è

②

e

“ ANGLE

③

i



DVD
VCD

(PBC)

VCD)

VCD

PBC

AUDI O

(PBC)

VCD

2.0

VCD -
AUDI O

TITLE C



-
- { PBC } "

" Li p

" Li p

① AUDI O SYNC

② VCL + -
0~ 200

è

-
" - { } "

中文(简体)

()

VCD/SVCD
VCD/SVCD

⏪ / ⏩

{ }

OK

OK

3

{ }

OK

中文(简体)

1 DISC MENU

选择摘要类型:
曲目摘要
盘片间隔
曲目间隔

2 d e
OK

{ }

{ }

{ }

01 A	02 B	03 C
04 D	05 E	06 F
退出		菜单

MP3/WMA

Windows Media CD MP3

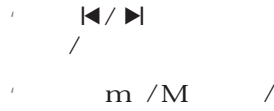

1

MP3/WMA

è / 30 è

4

x

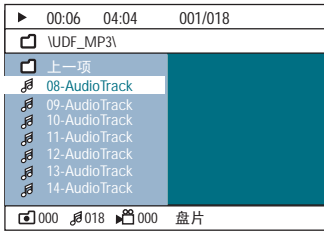

MP3/JPEG
JPEG NAV { MP3/
- CD }
- MP3/WMA
- “ MP3/WMA (ID3)

2

d e
OK

3

d e /
OK
è

中文(简体)

()

JPEG

① 12 x

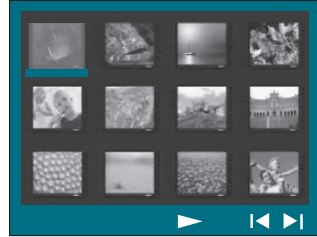

② ⏪ / ⏩

③ h i d e
O K

④ D I S C M E N U

① Z O O M

② h i d e

h i d e /

d
e
h
i

中文(简体)

JPEG CD Picture
CD JPEG

JPEG u

- /

- *.JPG
- *.JPEG
- JPEG-EXIF

JPEG JPEG
JPEG JPEG

MP3/VMA		Di vX	
JPEG		DVD	
	MP3/VMA	CD-R/RW	DVD+R/RW
	JPEG		Di vX

{ Di vX(R) VCD code } (Di VX(R))

- ① VMA MP3/
- ② CK
- ③ de CK
- ④ MENU x DI SC

- ① Di vX
- ② h i d e
- ③ CK

Di vX SUBTI TLE

Di vX AUDI O m /M / DI SPLAY “

è - .srt . sni .sub .ssa .ass

中文(简体)

USB

中文(简体)

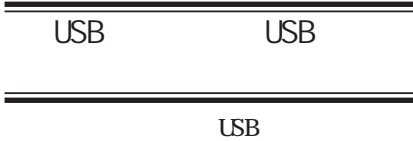

USB
JPEG MP3 Windows Media
DivX

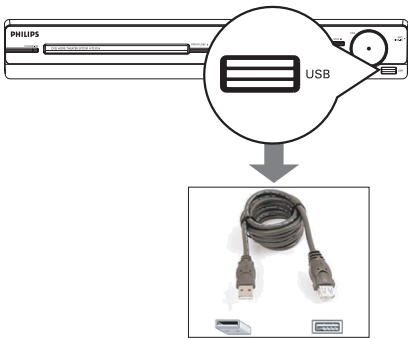

① USB /USB
USB

② 5



③ DI SC/USB

è

è

④ u
MP3/WMA “ JPEG
“ Di vX

DI SC/USB

⑤ USB
DI SC/USB ■

- USB
USB /USB
- USB
USB
- USB
USB
- USB

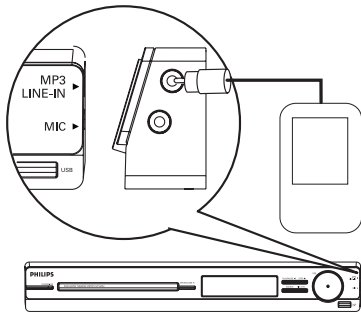

① MP3 LINE-IN

MP3 LINE-IN

② MP3 LINE-IN

③

④ STOP

DISC/USB RADIO

STOP

OK

OK

中文(简体)

1

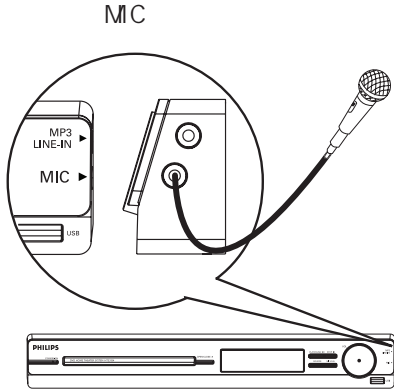

MIC

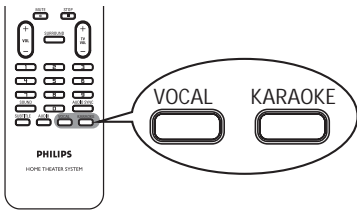

VOCAL KARAOKE

2

OK

d e

3

OK

OK
VOCAL

4

MIC LEVEL

1

KARAOKE

麦克风设定页	
麦克风	开
麦克风音量	关
回音级数	
音调	
记分	

2

d e

OK

{ }	OK
{ }	(0 ~ 20) 10
{ }	(0 ~ 20) 10
{ }	(- 10- +10) “ - 10 “ +10 “ 00
{ }	{ } OK

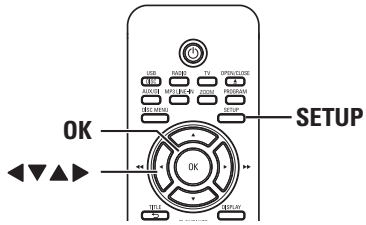

1
SETUP
è

2
h i
OK



SETUP { }
SETUP STOP x

3
d e
i

4
OK

è
è

5
SETUP

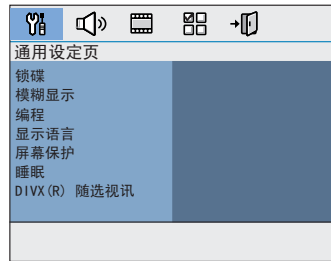

82

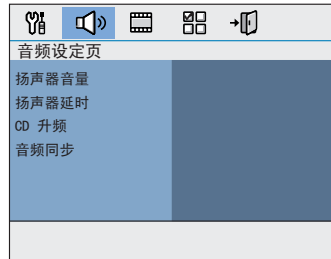

83

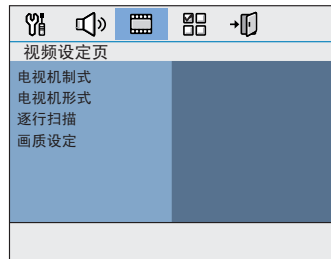

84

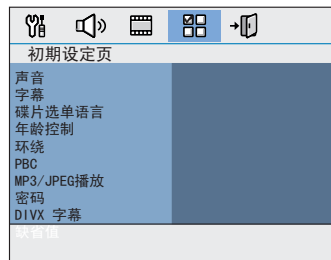

85~86

()

()

40

中文(简体)

{ } -

“ 136900
”

6

{ } -

{ } -

{ 100% } -

{ 70% } -

{ 40% } -

“

{ } -

5

{ } -

{ 15/30/45/60 } -

{ } -

Di vX(R)

Di vX® VCD
Di vX® VCD
Di vX® VCD

www.di.vx.com/vcd

i

OK

()

()

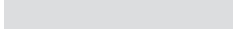

+6dB

h i

-6dB



“

h i

(1)

1

/



CD

CD

{ _____ }

-

CD

{ 88.2 kHz (X2) }

-

CD

-

CD

-

SURROUND

CD



h i

0-200

中文(简体)

()

()

中文(简体)



PAL NISC

{ PAL }

-

PAL

{ NTSC }

-

NTSC

{ ____ }

-

PAL

NTSC



{ ____ / ____ }

-



{ ____ / ____ }

-

“



{ 16:9 }

-

16:9



Y Pb Pr

“

-

{ ____ }

-

OK

{ ____ }

-

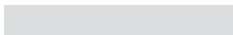

{ ____ }

-

{ ____ }

-

{ ____ }

-

{ ____ }

-

h i

OK

{ 0 }

个性化图像设定

亮度		0
对比度		0
色调		0
饱和度		0

()

()

DMD

DMD

DMD

/ /

DMD

中文(简体)

DMD

1) d e 1 8

OK

2) 0-9 6

- / (" 1

" 8

" 8

DMD

VCD SVCD CD

- DMD

6

{ _ }

-

{ }

-

PBC

VCD/SVCD

VCD (2.0)

{ _ }

-

VCD/SVCD

{ }

-

VCD/SVCD

()

()

MP3/JPEG

MP3/JPEG

中文(简体)

{ } - MP3/

{ _____ } - MP3/

650 /

“ 136900

1) OK

变更密码	
旧密码	<input type="text"/>
新密码	<input type="text"/>
确认密码	<input type="text"/>
确定	

2) 0-9 { }

6

“ 136900

3) { } 6

4) { } 6

5) OK

Di vX

Di vX

{ } -

{ } -

{ _____ } -

{ _____ } -

Ronan

{ } -

{ } -

{ } -

OK

... FM AMMW

① SOURCE " FM RADIO

② h / i

③ ②

④ d / e

/ (AMMW/ FM 9 kHz/ 10 kHz/100 kHz)

50 kHz

① SOURCE " FM

② " AMMW

③ u " GRID 9

" GRID 10

20 AMMW 40 FM

-

-

- 20

-

" 5

"

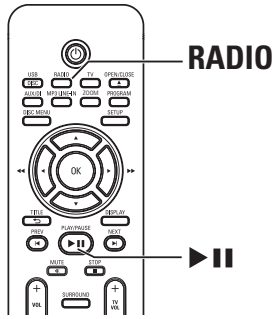

① RADIO " AUTO I INSTALL ... PRESS PLAY (... PLAY)

② u FM AMMW

è

è

è

()

中文(简体)

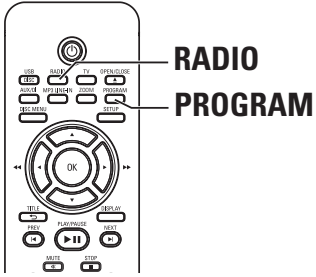

① RADIO “ FM “ AMMW

② ⏪ / ⏩

è

① RADIO “ FM “ AMMW

② PROGRAM
“ START ... (...)

è

① ⏪ / ⏩

② ^x
DELETED (“ FMAMMWX)

è

è

è

① “

② PROGRAM

③ ⏪ / ⏩

④ PROGRAM

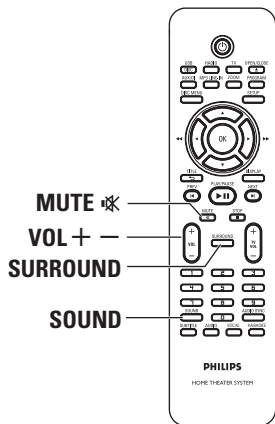

VOL +/-

è “ VOL MIN
“ VOL MAX

MUTE %

è “ MUTE ()

è MUTE %



SURROUND

è

è

DTS

II

è

()

SCUND

CONCERT	CLASSIC	DSD
DRAMA	JAZZ	
ACTION	ROCK	/
MTV	RnB	MTV
GAMING	PARTY	
CARTOON	LOUNGE	
SPORTS	SPORTS	
NEWS	NEWS	/
NO GHI	NO GHI	

- ① OPEN/CLOSE ▲
- ② DISPLAY
è
- ③ support “ www.philips.com/”
CD R
- ④ CD R
è
- ⑤ CD R
è
- ⑥

()

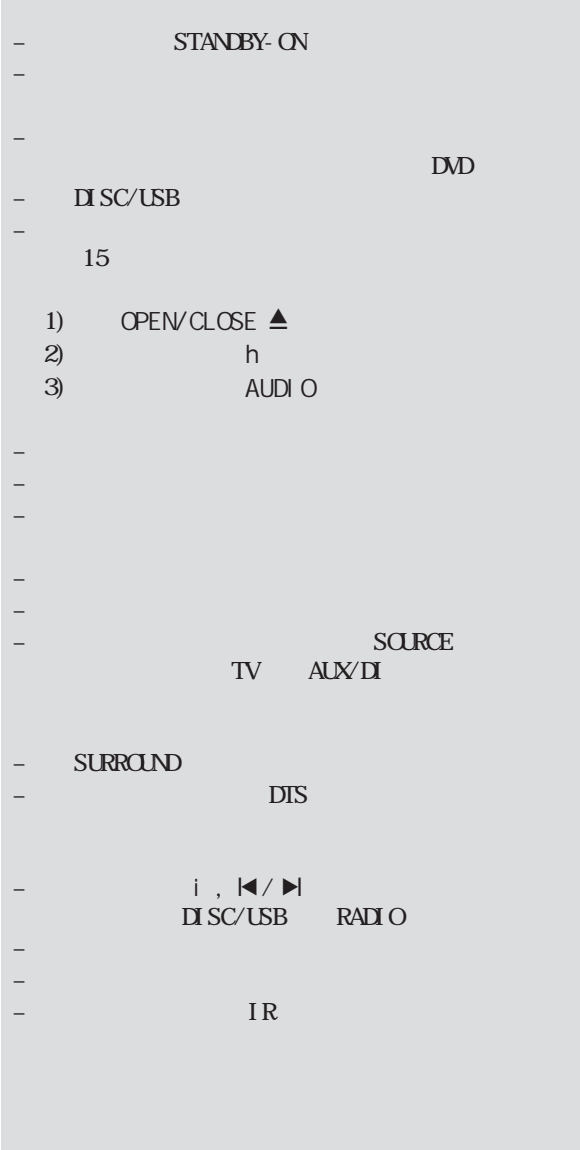

()

()

中文(简体)

DVD+R/CD-R

-

-

- SETUP

-

- 1

- DVD

-

- DVD

- DVD

- /

- STOP

-

- Di vX “

- Di vX

- Di vX

-

-

-

-

-

Di vX

USB

USB

- USB

-

NIFS

USB

-

USB

中文(简体)

(USB)

USB

" Good Bye. j pg"

500

" Good_B~1. j pg"

(FAT16)

(8)

1MB

USB

USB

USB

USB

(mp3)

EXIF

(j pg)

EXIF

USB

MP

NIFS

FAT16

FAT32

中文(简体)

		110-127 V / 220-240 V~
	300	50-60
	180 -18 / ±3 dB	60
	> 60 dB A	360 x 48 x 332
		x x
- AUX	500 mV	2.82
-	250 mV	
- MP3	500 mV	
		4 Ω
	FM 87.5-108	3"
	(50/100)	150 - 20
	AM 531-1602	95.5 x 198 x 75
	(9)	x x
	AM 530-1700	0.53 /
	(10)	
26 dB	FM 22 dBf,	
	AM 5000 μV/m	
IF	FM 60 dB, AM 24 dB	8 Ω
	FM 50 dB, AM 30 dB	3"
AM	FM 30 dB	150 - 20
	FM 3%	240 x 99.5 x 64
	FM 3%	x x
	AM 5%	
	FM 180 -9 /	0.85
	±6 dB	
	FM 26 dB (1)	
	FM 23.5 dB	8 Ω
		165 (6.5")
		40 - 150
	12 /8	131.2 x 315.5 x 386
	MPEG-1 / MPEG-2	x x
	DivX 3/4/5/6, Ultra	3.93
DAC	12	
	PAL / NTSC	
S/N	4:3 / 16:9	
	56 dB	
DAC	1.0 Vp-p, 75Ω	
	24 / 96	
	4 - 20	
	(44.1)	
	4 - 22	
	(48)	
	4 - 44	
	(96)	
PCM	IEC 60958	
	IEC 60958, IEC 61937	
DTS	IEC 60958 IEC 61937	

中文(简体)

AUDIO LEFT/RIGHT

4:3

II

16:9

4:3

II

II

/ kbps

DTS

DVD

JPEG

(CVBS)

" JPG JPEG

DVD

MP3

" MP3

1

MPEG 1 Audio Layer 3

DVX DVX

DVX Networks

MP3

CD-R

CD-RW

MPEG 4

CD

MPEG

_____ DVD

PBC

VCD/SVCD

_____ DVD

WMA Windows Media
Microsoft Corporation
WMA
Windows Media Player 9
Windows XP Windows Media
Player
“ WMA”

中文(简体)