

Register your product and get support at
www.philips.com/welcome

Immersive

3000 series



Quick start guide

PHILIPS

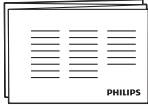

- EN** Before using your product, read all accompanying safety information
- ES** Antes de usar el producto, consulte la información de seguridad que se encuentra adjunta.
- PT** Antes de usar o produto, leia todas as informações de segurança em anexo.
- HI** अपने उत्पाद का उपयोग करने के पहले, साथ वाली सभी सुरक्षा जानकारी को पढ़ें
- RU** Перед тем как использовать это изделие, ознакомьтесь с информацией, касающейся безопасности.
- UK** Перед початком роботи прочитайте всю супутню інформацію про безпеку.



- EN** What's in the box
ES Contenido de la caja
PT Conteúdo da embalagem
HI बॉक्स में क्या है
RU Комплект поставки
UK Комплектація упаковок

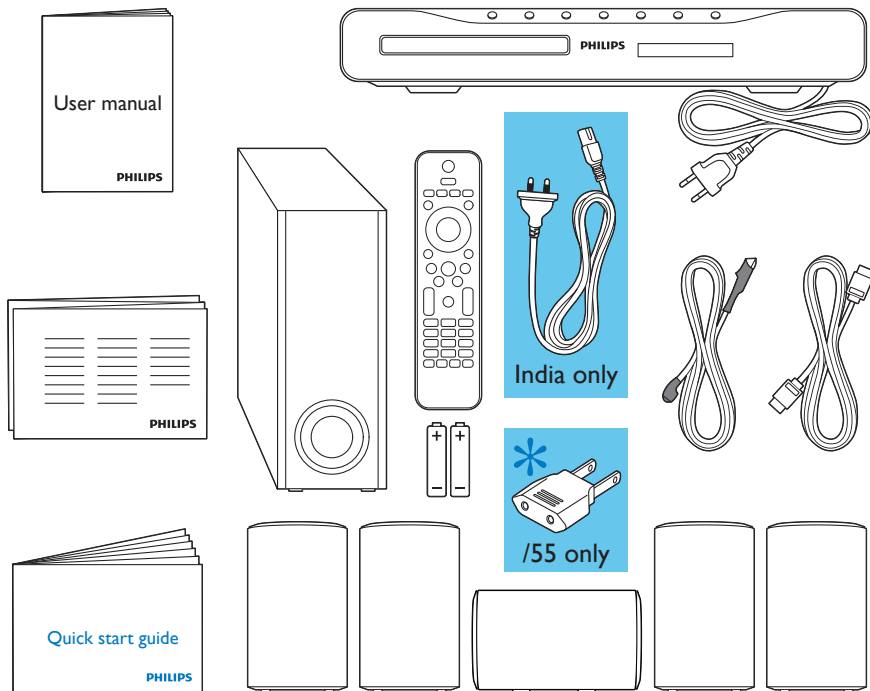

* Adaptador fornecido como acessório não deverá ser usado nas redes elétricas do Brasil, seu uso é destinado exclusivamente a outros países da América Latina.

1

- EN** Position the speakers
- ES** Ubicación de los altavoces
- PT** Posicionar as caixas acústicas
- HI** स्पीकर्स को स्थित कर
- RU** Расположите динамики.
- UK** Розташування гучномовців

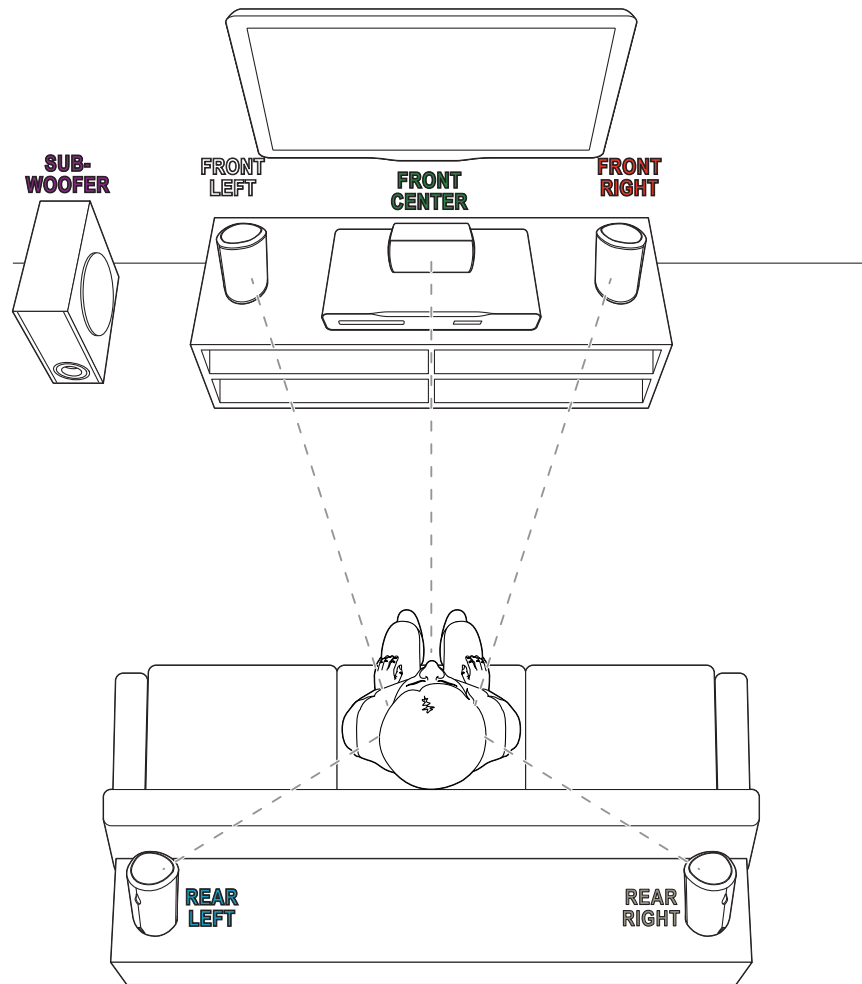

2

- EN** Connect the home theater
- ES** Conexión del Home Theater
- PT** Conectar o Home Theater
- HI** होम थिएटर को कनेक्ट करें
- RU** Подключите домашний кинотеатр.
- UK** Під'єднання системи домашнього кінотеатру

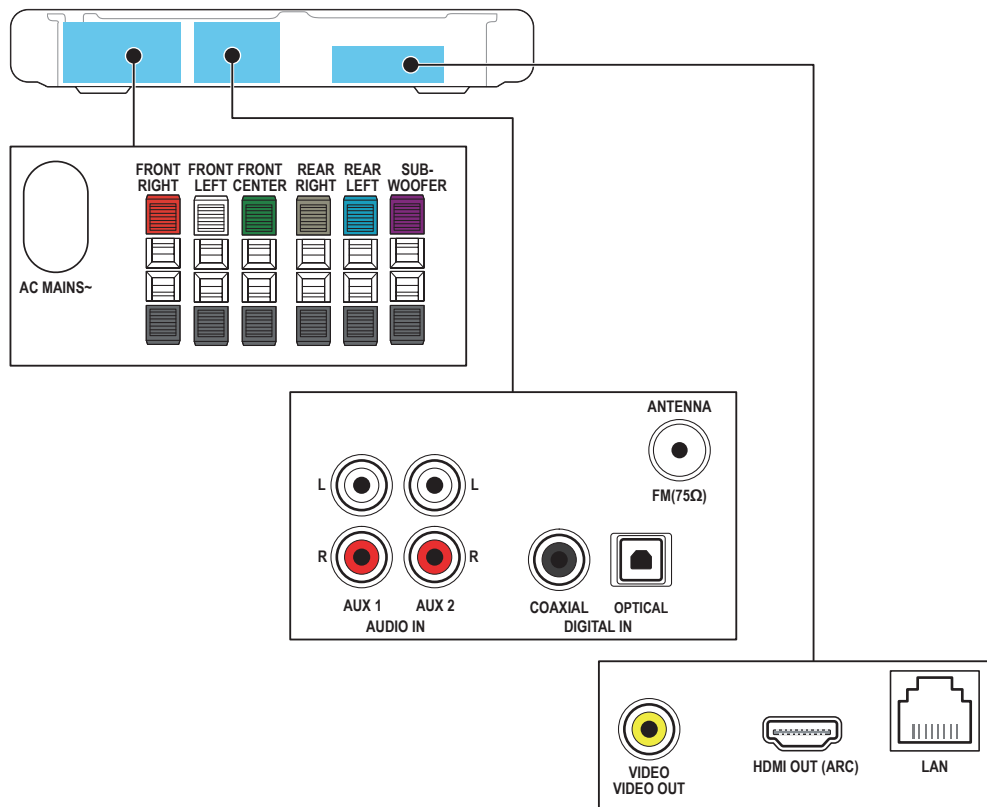

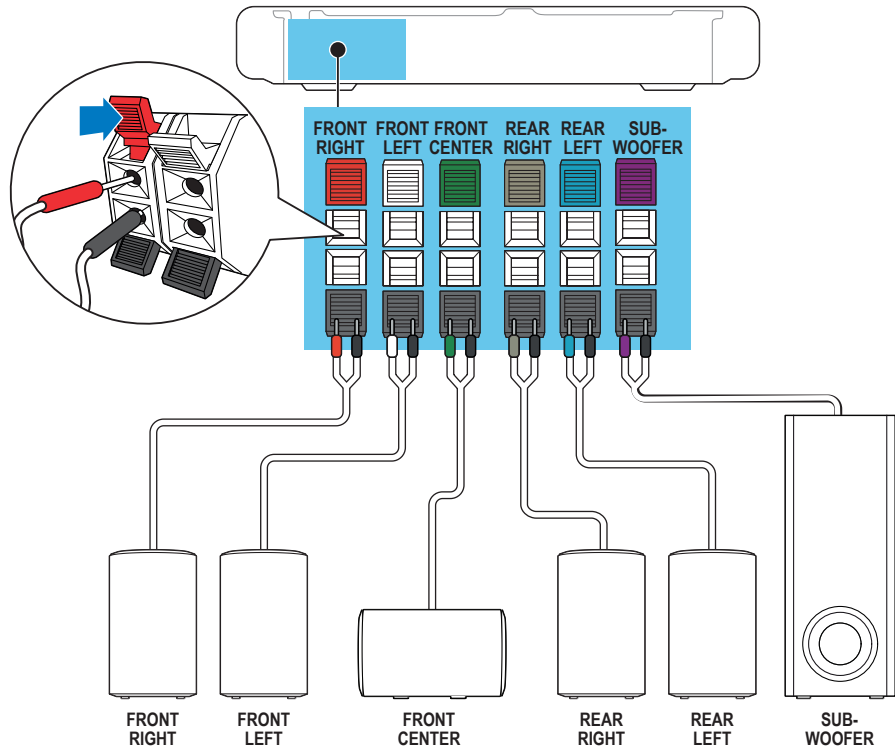

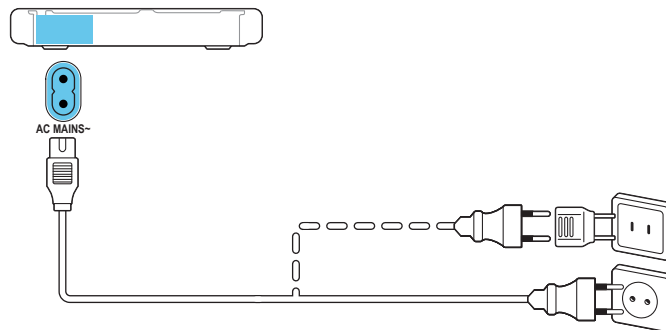
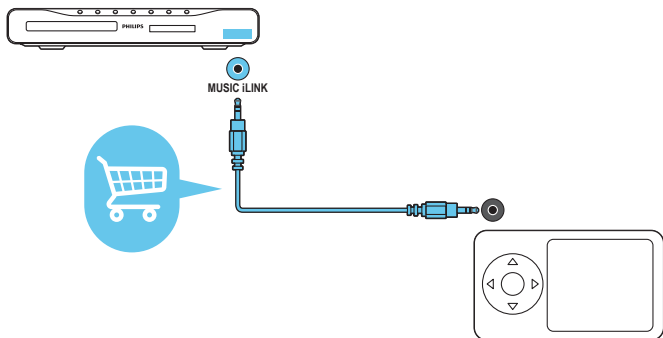
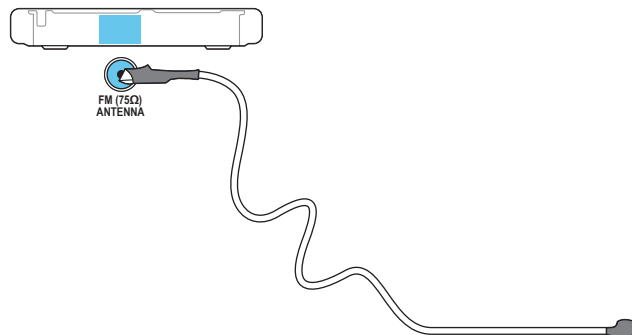
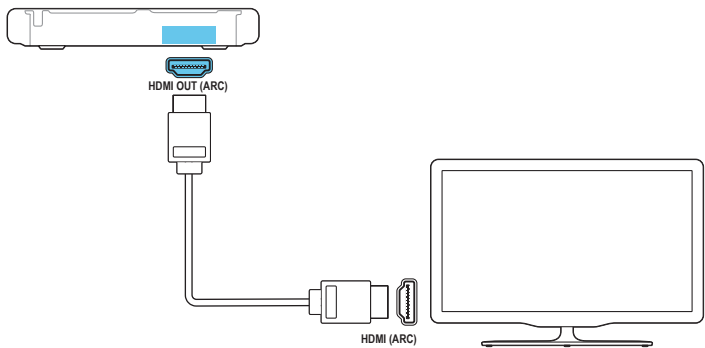

3

EN Switch on the home theater

ES Encendido del Home Theater

PT Ligar o Home Theater

HI होम थिएटर को स्विच ऑन करें

RU Включите домашний кинотеатр

UK Увімкнення системи домашнього кінотеатру

1

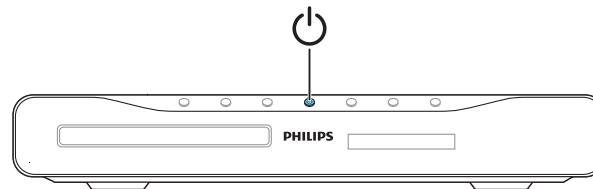

2

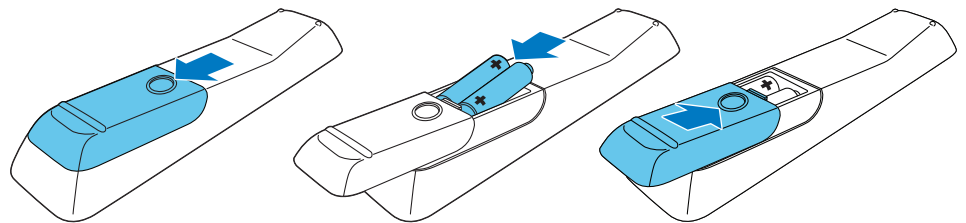



- EN** Complete the first time setup
- ES** Proceso de configuración inicial
- PT** Fazer a configuração inicial
- HI** पहली बार के सेटअप को पूर्ण करें
- RU** Выполните первоначальную настройку
- UK** Виконання перших налаштувань

1

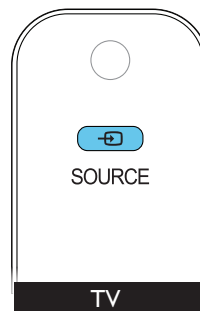
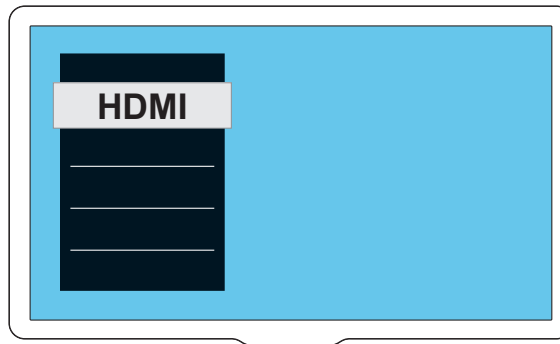

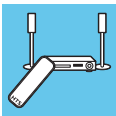

2

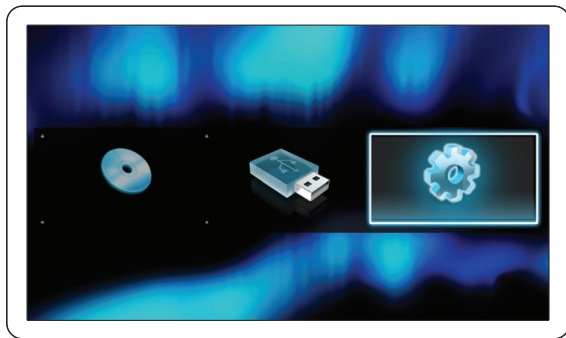

3

Video	Menu Language	Auto (ENG)
Audio	Audio	English
Network	Subtitle	Français
EasyLink	Disc Menu	Deutsch
Preference	Parental Control	Italiano
Advanced	Screen Saver	Español
	Change Password	Português
	Display Panel	Nederland

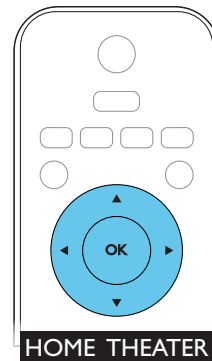
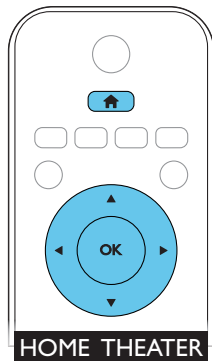

5

EN Use your home theater

ES Uso del sistema de Home Theater

PT Usar o Home Theater

HI अपने होम थिएटर का उपयोग करें

RU Домашний кинотеатр готов к использованию

UK Використання системи домашнього кінотеатру

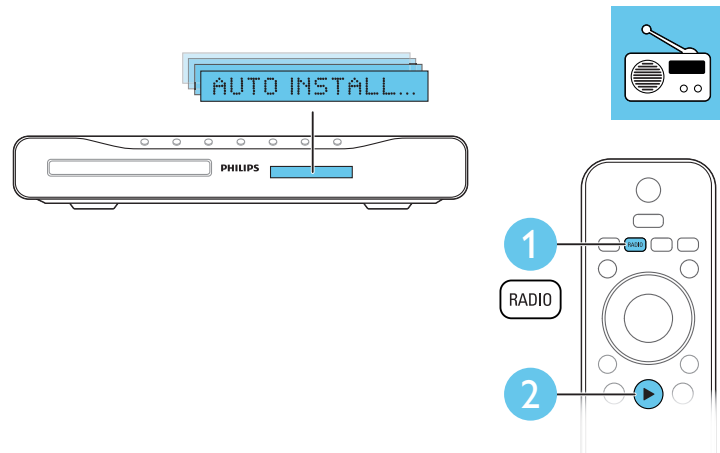
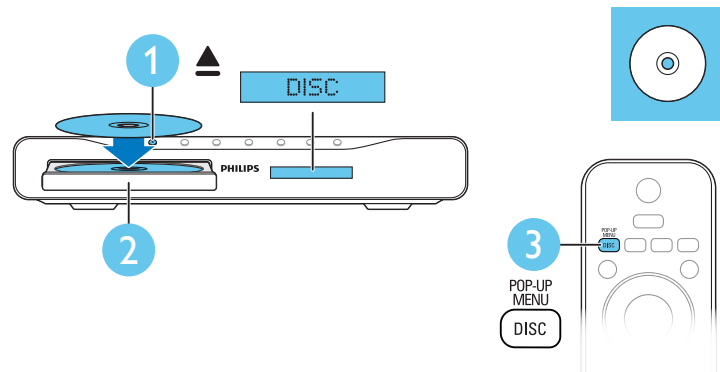

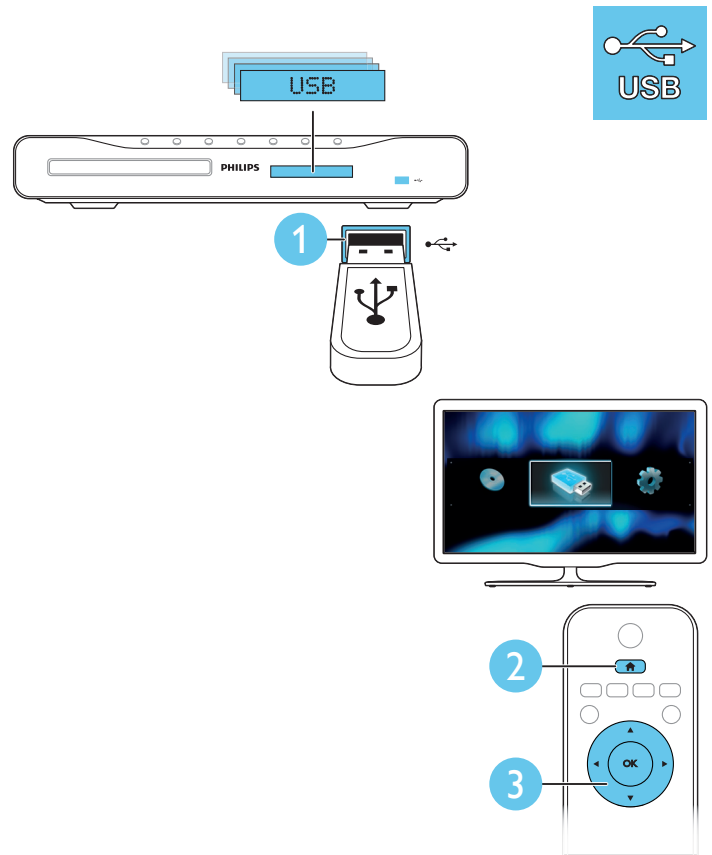
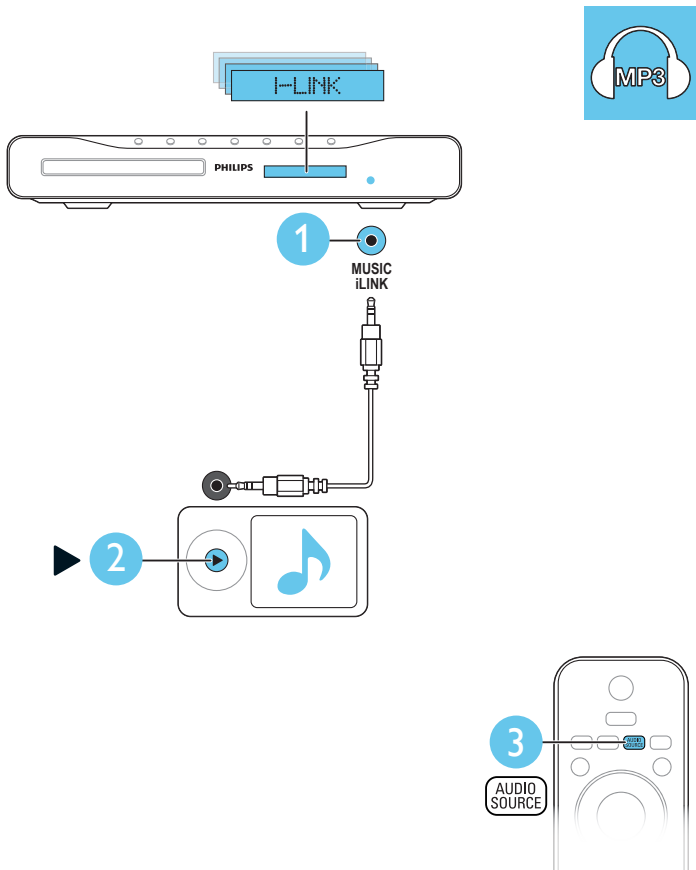



- EN** Download software updates and a printable user manual from www.philips.com/support.
- ES** Descargue actualizaciones de software y un manual del usuario para imprimir en www.philips.com/support
- PT** Faça o download de atualizações do software e do manual do usuário em www.philips.com/support.
- HI** www.philips.com/support पर जाकर सॉफ्टवेयर अपडेट और मुद्रणयोग्य उपयोगकर्ता निर्देशिका को मुद्रित करें.
- RU** Загрузите обновленное ПО и руководство пользователя с веб-сайта www.philips.com/support.
- UK** Завантажуйте оновлення програмного забезпечення та додатний для друку посібник користувача на сторінці www.philips.com/support.





Non-contractual images. / Images non contractuelles. / Außervertragliche Bilder.

All registered and unregistered trademarks are property of their respective owners.

Specifications are subject to change without notice

Trademarks are the property of Koninklijke Philips Electronics N.V. or their respective owners

2011 © Koninklijke Philips Electronics N.V. All rights reserved

www.philips.com

sgtt_1112/51.55,78_v1

Evite o uso prolongado do aparelho com volume superior a 85 decibéis, pois isto poderá prejudicar a sua audição.

Potência total de saída de 240W RMS, 10% THD



Be responsible
Respect copyrights

