

PhotoFrame

SPF1017

SPF1027



Quick start guide

1 Get started

2 Play

3 Setup

PHILIPS

EN

What's in the box

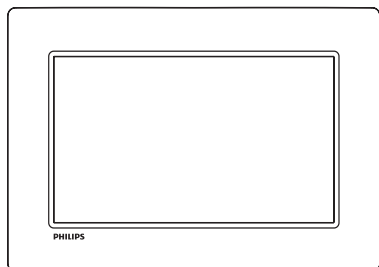

Philips Digital PhotoFrame

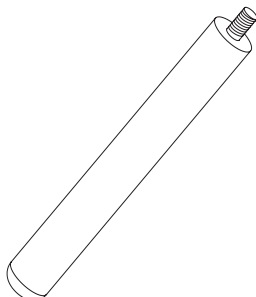

Stand

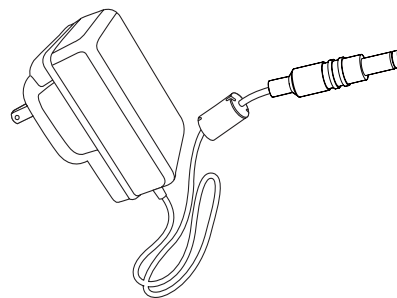

AC-DC power adaptor



CD-ROM,
• Digital User Manual
• Auto Run software



Quick Start Guide

What you also need

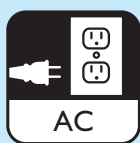

AC power socket

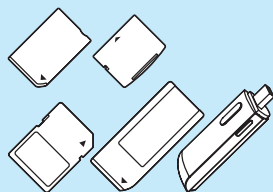



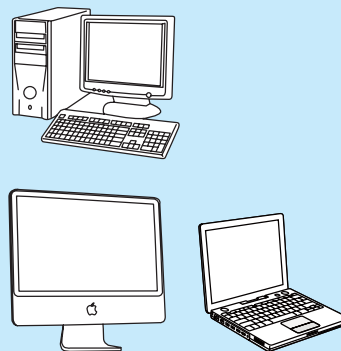

Memory card/USB



Computer

1 Get started

Control buttons

- ① 
 - Turn on/off the PhotoFrame
- ② 
 - Toggle between slideshow mode, thumbnail mode, and main menu
- ③ 
 - Select the previous/next/right/left option
- ④ 
 - Play photos in slideshow mode, browse mode, or clock mode
 - Pause slideshow
 - Confirm a selection
- ⑤ 
 - Enter/Exit photo menu

Install the stand

To place the PhotoFrame on a flat surface, attach the supplied stand to the back of the PhotoFrame.

- 1 Insert the stand into the PhotoFrame.

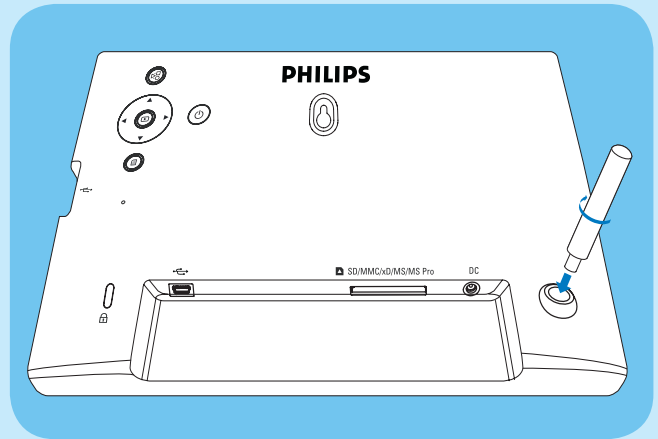

- 2 Screw the stand into the stand hole firmly.

Connect power

Note

- When you position the PhotoFrame, ensure that the power plug and outlet are easily accessible.

- 1 Connect the power cord to the **DC** socket of the PhotoFrame.

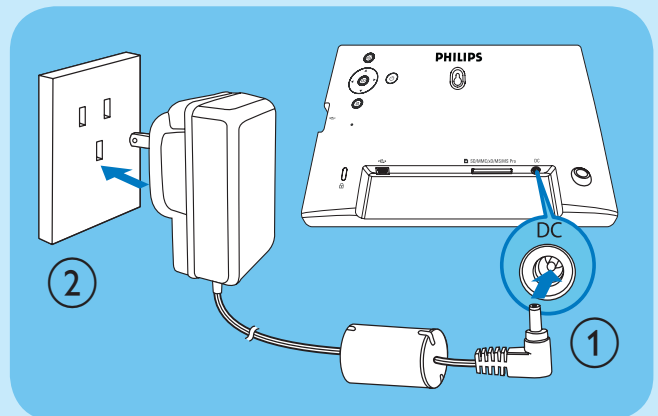

- 2 Connect the power cord to a power supply socket.

Turn on the PhotoFrame

Note

- You can only turn off the PhotoFrame after all copy and save actions are complete.

- Press and hold \odot for more than 1 second.
 - Photos are displayed in slideshow mode.
 - To turn off the PhotoFrame, press and hold \odot .

Connect a storage device

Caution

- Do not remove a storage device from the PhotoFrame when files are transferring from or to the storage device.

You can play JPEG photos in one of the following storage device which is connected to the PhotoFrame:

- Secure Digital (SD)
- Secure Digital (SDHC)
- Multimedia Card (MMC)
- xD card (xD)
- Memory Stick (MS)
- Memory Stick Pro (with adaptor)
- USB memory drive

However, we do not guarantee the operations for all types of memory card media.

- For xD/SD/MMC/MS/MS Pro card, insert it into the slot until you hear a "CLICK".
 - For USB memory drive, insert it into the slot firmly.

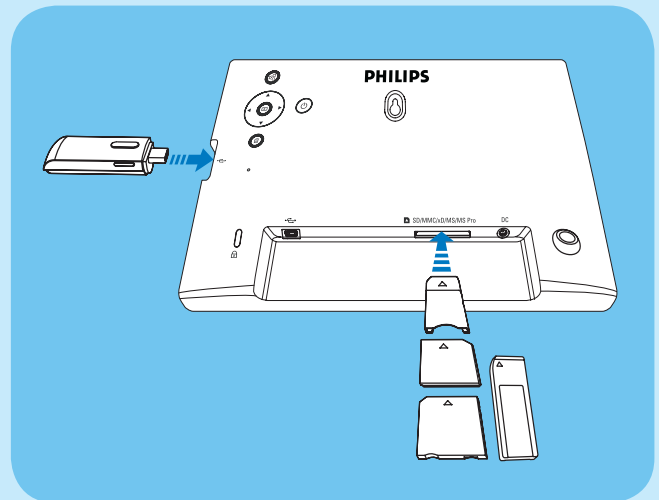

- Photos in the storage device are displayed in slideshow mode.

To remove a storage device:

- For xD/SD/MMC/MS/MS Pro card, push the card inward and then pull it out.

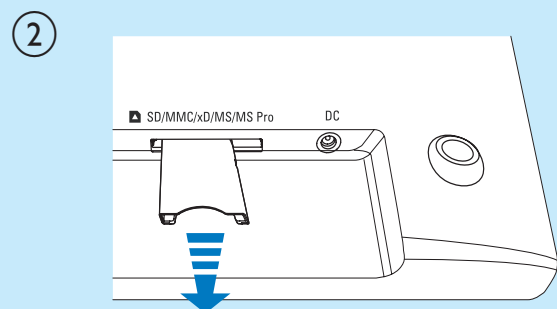
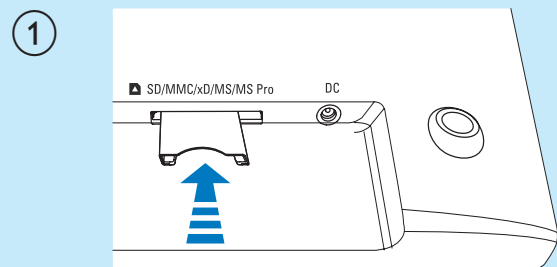

- For USB memory drive, pull it out from the PhotoFrame.

2 Play

Play photos

- 1 In the main menu, select **[Photo]** and then press  to confirm.

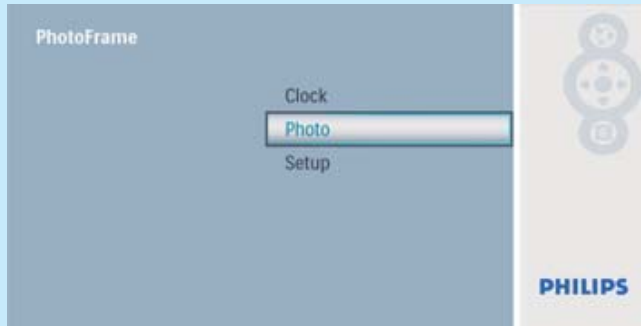

- 2 Select a photo source, and then press  to confirm.

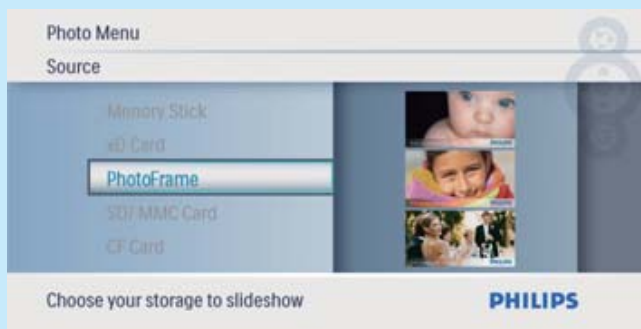



- 3 Select a photo, and then press  to confirm.

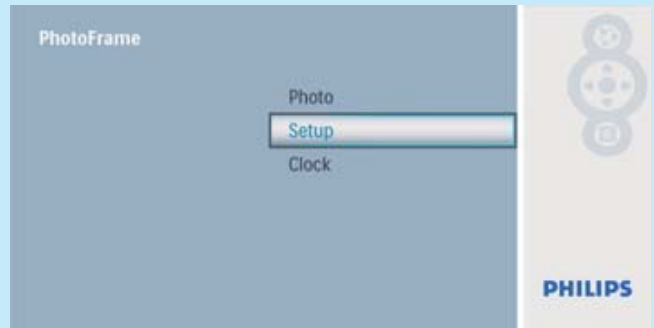

Display collage photos

- 1 In the main menu, select **[Setup]** and then press  to confirm.



- 2 Select **[Collage]**, and then press  to confirm.



- 3 Select **[Random]**, and then press  to confirm.



- To disable collage function, select **[Off]** and then press  to confirm.

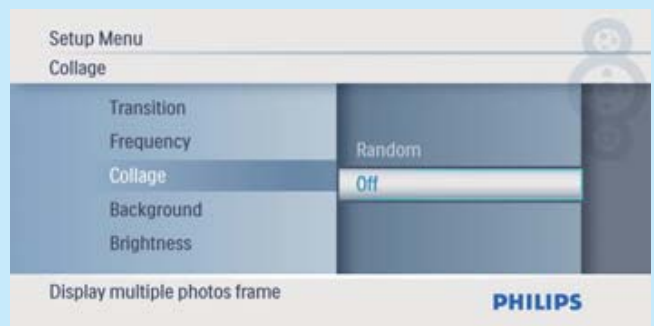

3 Setup

Select an on-screen language

- 1 In the main menu, select **[Setup]** and then press  to confirm.

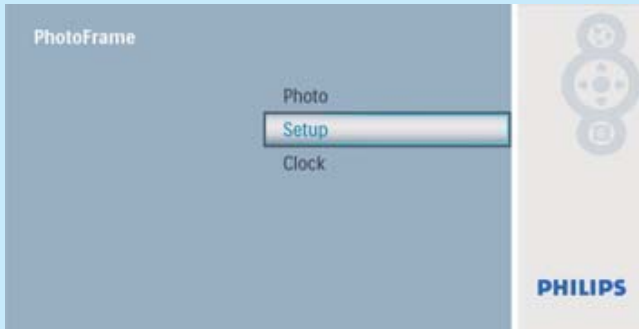

- 2 Select **[Language]**, and then press  to confirm.

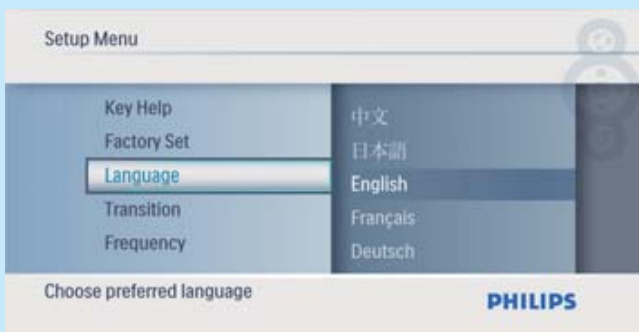



- 3 Select a language, and then press  to confirm.

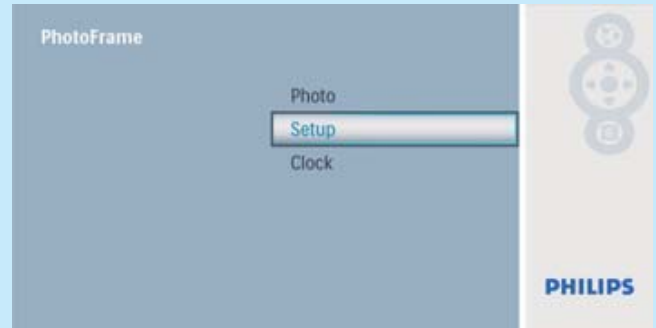

Select a photo background

- 1 In the main menu, select **[Setup]** and then press  to confirm.



- 2 Select **[Background]**, and then press  to confirm.



- 3 Select an option, and then press  to confirm.
↳ If you select a background color, the PhotoFrame displays a photo with a background color.



- ↳ If you select **[Auto Fit]**, the PhotoFrame extends a photo to fill the screen with picture distortion.



↳ If you select **[RadiantColor]**, the PhotoFrame extends the color on the edges of a photo that is smaller than the full screen to fill the screen without black bars or aspect ratio distortion.



Set display auto on/off

You can configure the time for the PhotoFrame to turn on or off the display automatically.

Note

- Ensure that you set the current time and date of the PhotoFrame before you set the auto on/off function.

1 In the main menu, select **[Setup]** and then press  to confirm.

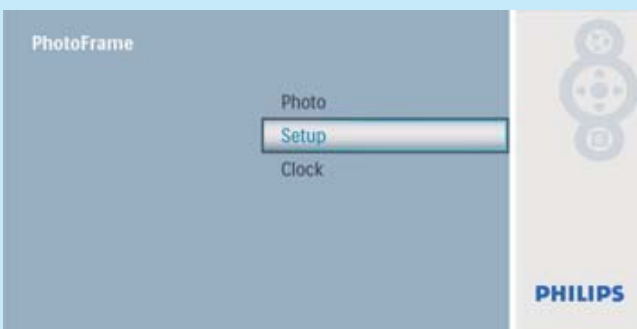



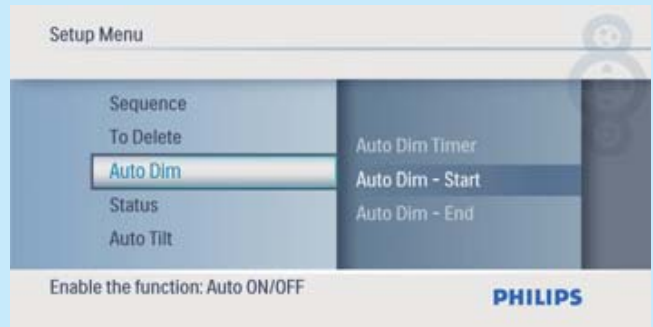

2 Select **[Auto Dim]**, and then press  to confirm.



3 Select **[Auto Dim - End]** / **[Auto Dim - Start]**, and then press  to confirm.



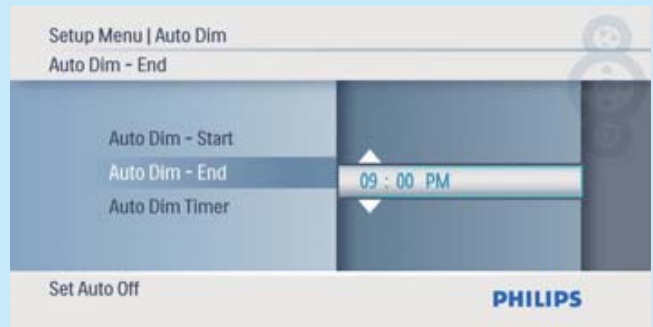

4 Press /// to set time for auto-on/ auto-off, and then press  to confirm.

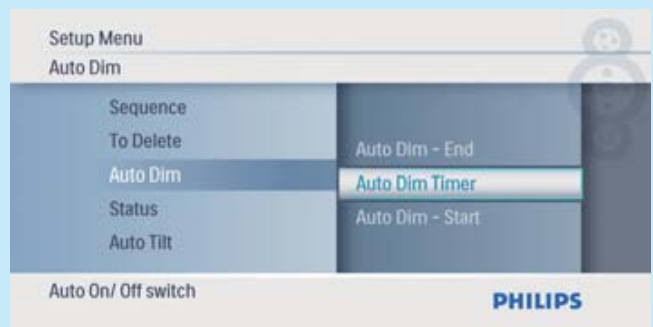

5 Select **[Auto Dim Timer]**, and then press  to confirm.



- 6 Select **[On]**, and then press  to confirm.
- To set off auto-on/auto-off function, select **[Off]** and then press  to confirm.

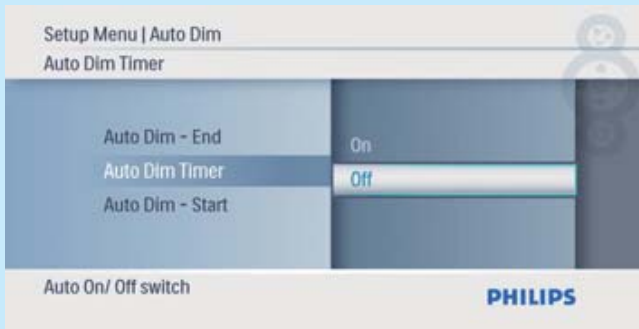



Set time and date

- 1 In the main menu, select **[Clock]** and then press  to confirm.



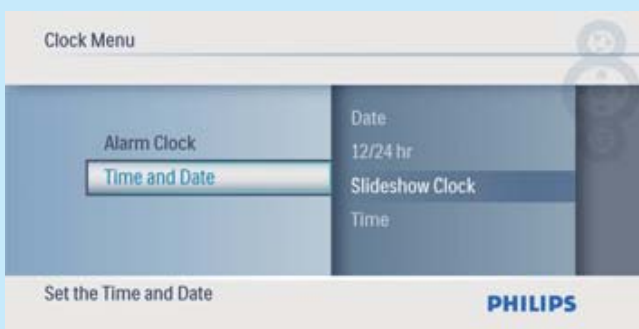





- 2 Select **[Time and Date]**, and then press  to confirm.



- Select **[12/24 hr]** > **[12HR]** / **[24HR]**, and then press  to confirm.





- 3 Select **[Time]** / **[Date]**, and then press  to confirm.
- 4 Press  /  /  /  to set time/date, and then press  to confirm.

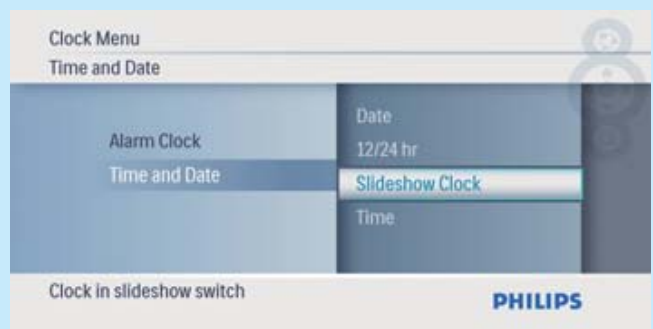

Show clock in slideshow

- 1 In the **[Time and Date]** menu, select **[Slideshow Clock]** and then press  to confirm.



- 2 Select **[Yes]**, and then press  to confirm.

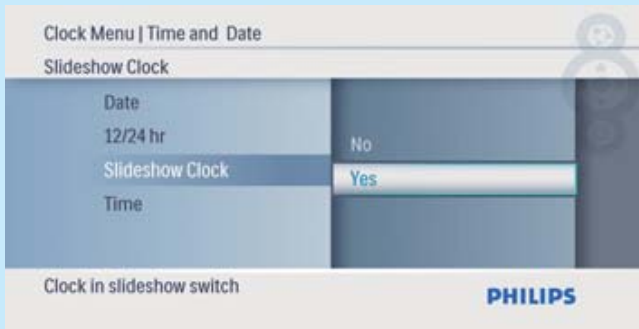

↳ You can have clock shown in slideshow.

Set alarm clock

Note

- Ensure that you set time and date of you PhotoFrame correctly.

- 1 In the main menu, select **[Clock]** and then press  to confirm.





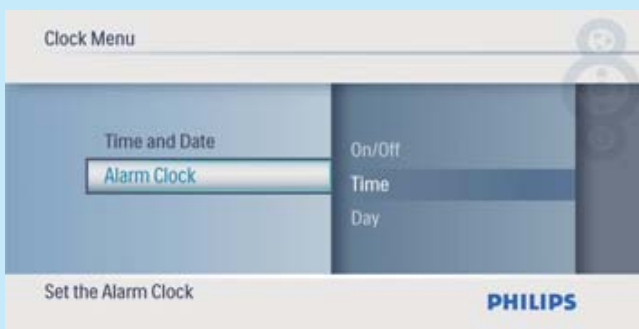



- 2 Select **[Alarm Clock]**, and then press  to confirm.

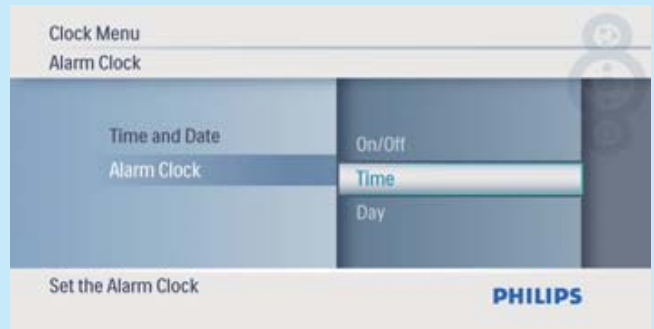



↳ The **[Alarm Clock]** menu is displayed.

- 3 Select **[Time]**, and then press  to confirm.

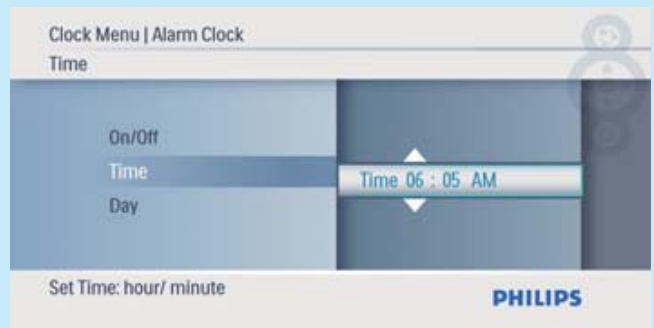

- 4 Press /// to set time for an alarm clock, and then press  to confirm.



- 5 Select **[Day]** for an alarm clock, and then press  to confirm.

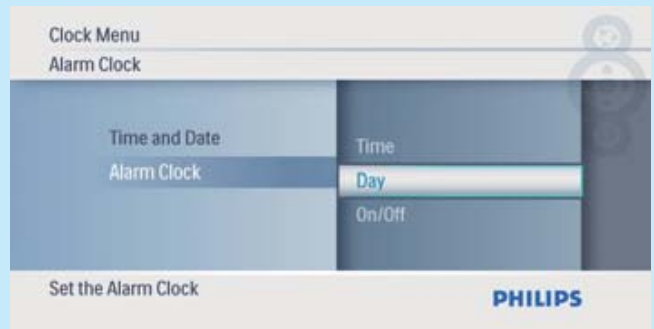



- 6 Selection an option, and then press  to confirm.

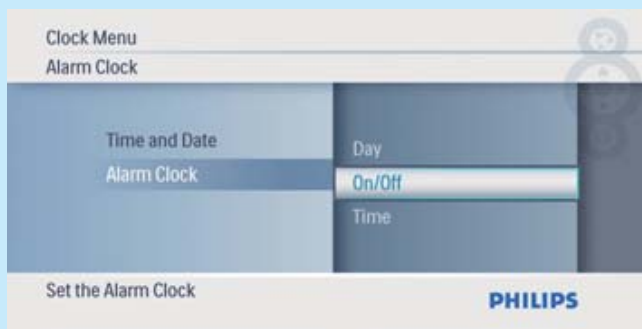

- 7 Select **[On/Off]**, and then press  to confirm.



- 8 Select **[On]**, and then press  to confirm.
- To set off an alarm clock, select **[Off]** and then press  to confirm.

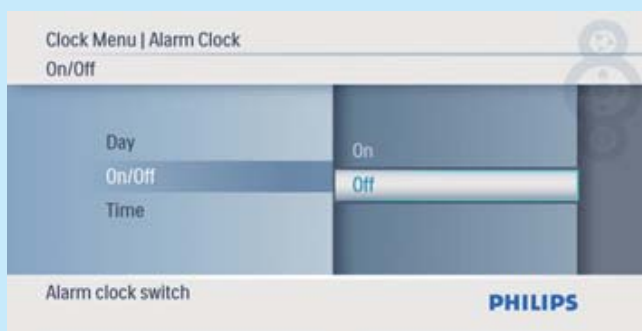

Frequently asked questions

Is the LCD screen touch-enabled?

The LCD screen is not touch-enabled. Use the buttons on the back to control the PhotoFrame.

Will the LCD be damaged, if I keep showing the same photo for a long time?

No. The PhotoFrame can display the same photo continuously for 72 hours without any damage to the LCD screen.

Why does my PhotoFrame not show some of my photos?

The PhotoFrame supports only JPEG photos. Ensure that these JPEG photos are not damaged.

Why does the PhotoFrame not go into auto-off status after I set it?

Ensure that you set the current time, auto-off time, and auto-on time correctly. The PhotoFrame automatically turns off its display exactly at the auto-off time. If the time has already passed for the day, it starts to enter auto-off status at the specified time from the next day.

Can I use the PhotoFrame during its display auto-off periods?

Yes. You can press \odot to wake up the PhotoFrame.

Welcome to Philips!

Register your product and get support at
www.philips.com/welcome



© Royal Philips Electronics N.V. 2009
All rights reserved.

Specifications are subject to change without notice.
Trademarks are the property of Koninklijke Philips
Electronics N.V. or their respective owners.