

# Always there to help you

Register your product and get support at  
[www.philips.com/welcome](http://www.philips.com/welcome)

Question?  
Contact  
Philips

DCB2020



## User manual

# PHILIPS

# Contents

<b>1</b>	<b>Safety and Notice</b>	<b>2</b>
	Safety	2
	Notice	4
<b>2</b>	<b>Your Micro Music System</b>	<b>5</b>
	Introduction	5
	What's in the box	5
	Overview of the remote control	5
	Overview of the main unit	7
<b>3</b>	<b>Before use</b>	<b>8</b>
	Place the product	8
	Connect speakers	8
	Connect power	9
	Install/replace the remote control batteries	9
<b>4</b>	<b>Get started</b>	<b>10</b>
	Turn on	10
	Set clock	10
	Demonstrate features	10
<b>5</b>	<b>Play</b>	<b>11</b>
	Play a disc	11
	Play from a USB storage device	11
	Basic control	11
	Program audio tracks	11
	Adjust sound	12
<b>6</b>	<b>Play from iPod/iPhone/iPad</b>	<b>12</b>
	Compatible iPod/iPhone/iPad	12
	Load the iPod/iPhone/iPad	12
	Charge the iPod/iPhone/iPad	13
	Listen to the iPod/iPhone/iPad	13
	Remove the iPod/iPhone/iPad	13
<b>7</b>	<b>Listen to radio</b>	<b>14</b>
	Store DAB radio stations automatically	14
	Basic operations	14
	Use the menu	15
<b>8</b>	<b>Other features</b>	<b>16</b>
	Set sleep timer	16
	Set alarm timer	16
	Listen to external audio device	16
	Listen through headphone	17
<b>9</b>	<b>Upgrade the firmware</b>	<b>17</b>
	Register your product	17
	Check the current firmware version	18
	Perform the upgrade	18
<b>10</b>	<b>Product information</b>	<b>18</b>
	Specifications	18
	USB playability information	19
	Supported MP3 disc formats	19
	RDS program types	20
<b>11</b>	<b>Troubleshooting</b>	<b>21</b>

# 1 Safety and Notice

Read and understand all instructions before you use this product. If damage is caused by failure to follow the instructions, the warranty does not apply.

---

## Safety



This 'bolt of lightning' indicates uninsulated material within your unit may cause an electrical shock. For the safety of everyone in your household, please do not remove product covering.



The 'exclamation point' calls attention to features for which you should read the enclosed literature closely to prevent operating and maintenance problems.

**WARNING:** To reduce the risk of fire or electric shock, this apparatus should not be exposed to rain or moisture and objects filled with liquids, such as vases, should not be placed on this apparatus.

**CAUTION:** To prevent electric shock, match wide blade of plug to wide slot, fully insert.

### Risk of electric shock or fire!

- Never expose the product and accessories to rain or water. Never place liquid containers, such as vases, near the product. If liquids are spilt on or into the product, disconnect it from the power outlet

immediately. Contact Philips Consumer Care to have the product checked before use.

- Never remove the casing of this apparatus.
- Never place the product and accessories near naked flames or other heat sources, including direct sunlight.
- Never insert objects into the ventilation slots or other openings on the product.
- Where the mains plug or an appliance coupler is used as the disconnect device, the disconnect device shall remain readily operable.
- Disconnect the product from the power outlet before lightning storms.
- When you disconnect the power cord, always pull the plug, never the cable.

### Risk of short circuit or fire!

- Before you connect the product to the power outlet, ensure that the power voltage matches the value printed on the back of the product. Never connect the product to the power outlet if the voltage is different.
- Never expose the remote control or batteries to rain, water or excessive heat.
- Avoid force coming onto power plugs. Loose power plugs can cause arcing or fire.

### Risk of injury or damage to the product!

- Visible and invisible laser radiation when open. Avoid exposure to beam.
- Do not touch the disc optical lens inside the disc compartment. Never place the product or any objects on power cords or on other electrical equipment.
- If the product is transported in temperatures below 5°C, unpack the product and wait until its temperature matches room temperature before connecting it to the power outlet.

### Risk of overheating!

- Never install this product in a confined space. Always leave a space of at least four inches around the product for ventilation. Make sure that curtains or other objects never cover the ventilation slots on the product.

### Risk of contamination!

- Remove the battery if it is exhausted or if the remote control is not to be used for an extended period of time.
- Batteries contain chemical substances, they should be disposed of properly.

---

### Care for your product

- Do not insert any objects other than discs into the disc compartment.
- Do not insert warped or cracked discs into the disc compartment.
- Remove the discs from the disc compartment if you are not using the product for an extended period of time.
- Only use microfiber cloth to clean the product.

---

### Care of the environment



Your product is designed and manufactured with high quality materials and components, which can be recycled and reused.



When this crossed-out wheeled bin symbol is attached to a product it means that the product is covered by the European Directive 2002/96/EC. Please inform yourself about the local separate collection system for electrical and electronic products.

Please act according to your local rules and do not dispose of your old products with your normal household waste. Correct disposal of your old product helps to prevent potential negative consequences for the environment and human health.



Your product contains batteries covered by the European Directive 2006/66/EC, which cannot be disposed with normal household waste. Please inform yourself about the local rules on separate collection of batteries because correct disposal helps to prevent negative consequences for the environmental and human health.

---

### Compliance

This apparatus includes this label:



#### Note

- The type plate is located on the bottom of the apparatus.

---

### Hearing safety



#### Caution

- To prevent possible hearing damage, do not listen at high volume levels for long periods.

**Listen at a moderate volume:**

- Using headphones at a high volume can impair your hearing. This product can produce sounds in decibel ranges that may cause hearing loss for a normal person, even for exposure less than a minute. The

higher decibel ranges are offered for those that may have already experienced some hearing loss.

- Sound can be deceiving. Over time your hearing 'comfort level' adapts to higher volumes of sound. So after prolonged listening, what sounds 'normal' can actually be loud and harmful to your hearing. To guard against this, set your volume to a safe level before your hearing adapts and leave it there.

#### To establish a safe volume level:

- Set your volume control at a low setting.
- Slowly increase the sound until you can hear it comfortably and clearly, without distortion.

#### Listen for reasonable periods of time:

- Prolonged exposure to sound, even at normally 'safe' levels, can also cause hearing loss.
- Be sure to use your equipment reasonably and take appropriate breaks.

#### Be sure to observe the following guidelines when using your headphones.

- Listen at reasonable volumes for reasonable periods of time.
- Be careful not to adjust the volume as your hearing adapts.
- Do not turn up the volume so high that you can't hear what's around you.
- You should use caution or temporarily discontinue use in potentially hazardous situations.
- Do not use headphones while operating a motorized vehicle, cycling, skateboarding, etc.; it may create a traffic hazard and is illegal in many areas.

---

## Notice

Any changes or modifications made to this device that are not expressly approved by Philips Consumer Lifestyle may void the user's authority to operate the equipment.

#### Environmental information

All unnecessary packaging has been omitted. We have tried to make the packaging easy to separate into three materials: cardboard (box), polystyrene foam (buffer) and polyethylene (bags, protective foam sheet.)

Your system consists of materials which can be recycled and reused if disassembled by a specialized company. Please observe the local regulations regarding the disposal of packaging materials, exhausted batteries and old equipment.



**Be responsible**  
**Respect copyrights**

The making of unauthorized copies of copy-protected material, including computer programs, files, broadcasts and sound recordings, may be an infringement of copyrights and constitute a criminal offence. This equipment should not be used for such purposes.

Made for



iPod



iPhone



iPad

"Made for iPod," "Made for iPhone," and "Made for iPad" mean that an electronic accessory has been designed to connect specifically to iPod, iPhone, or iPad, respectively, and has been certified by the developer to meet Apple performance standards. Apple is not responsible for the operation of this device or its compliance with safety and regulatory standards. Please note that the use of this accessory with iPod, iPhone, or iPad may affect wireless performance.

iPod and iPhone are trademarks of Apple Inc., registered in the U.S. and other countries. iPad is a trademark of Apple Inc.

## 2 Your Micro Music System

Congratulations on your purchase, and welcome to Philips! To fully benefit from the support that Philips offers, register your product at [www.philips.com/welcome](http://www.philips.com/welcome).

### Introduction

With this product, you can:

- enjoy audio from discs, USB storage devices, iPod, iPhone, iPad, and other external devices
- listen to radio stations

You can enrich sound output with these sound effects:

- Digital sound control (DSC)
- Dynamic bass boost (DBB)

The product supports these media formats:



### What's in the box

Check and identify the contents of your package:

- Main unit
- Speaker X 2
- Rubber bumper for iPad 2
- 2 x AAA batteries
- Remote control
- User manual
- Quick start guide

### Overview of the remote control

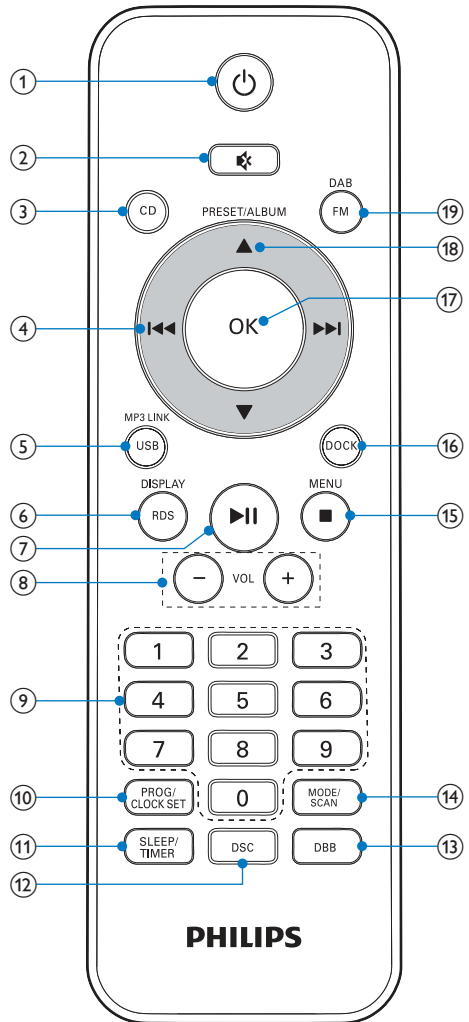

- ①
  - Turn on the product.
  - Switch to eco-power standby mode or normal standby mode.
- ②
  - Mute or restore volume.

- ③ **CD**
  - Select CD source.
- ④ **⏮ / ⏭**
  - Skip to the previous or next track.
  - Press and hold to search within a track/disc.
  - Tune to a radio station.
- ⑤ **MP3 LINK/USB**
  - Select MP3 LINK or USB source.
- ⑥ **RDS/DISPLAY**
  - Synchronize the clock with an RDS radio station that transmits time signals.
  - Display the current status or media information.
  - Display available ID3 information of MP3 tracks.
  - When playing music from CD or USB storage device, press to display the clock.
- ⑦ **▶ ||**
  - Start, pause, or resume play.
  - In DAB or FM mode, confirm the menu option.
- ⑧ **VOL +/-**
  - Adjust the volume level or time.
- ⑨ **Numeric keypad**
  - Enter numbers.
  - Enter the track number to select a track directly.
  - Enter the sequence number to select a preset radio station.
- ⑩ **PROG/CLOCK SET**
  - Program audio tracks.
  - Program radio stations.
  - Set the clock.
- ⑪ **SLEEP/TIMER**
  - Set the sleep timer or alarm timer.
- ⑫ **DSC**
  - Select a preset sound setting.
- ⑬ **DBB**
  - Turn on or off dynamic bass enhancement.
- ⑭ **MODE/SCAN**
  - Select a play mode: normal play, repeat, or shuffle.
  - Search for available FM or DAB radio stations.
- ⑮ **■ / MENU**
  - Stop the play of music.
  - Press twice to erase a program.
  - In normal standby mode, turn on or off feature demonstration.
  - In DAB or FM mode, access the menu.
  - Access the playlist of iPod/iPhone.
- ⑯ **DOCK**
  - Select the dock source for iPod/iPhone/iPad.
- ⑰ **OK**
  - In DAB or FM mode, confirm the menu option.
  - In FM mode and with no menu option displayed, switch the sound mode between stereo and monophonic.
  - After you select a file from the playlist of iPod/iPhone/iPad, press **OK** to start play.
- ⑱ **PRESET/ALBUM ▲ / ▼**
  - Skip to the previous or next album.
  - Select a preset radio station.
  - Navigate through iPod/iPhone/iPad menu.
- ⑲ **DAB/FM**
  - Select DAB or FM radio source.

## Overview of the main unit

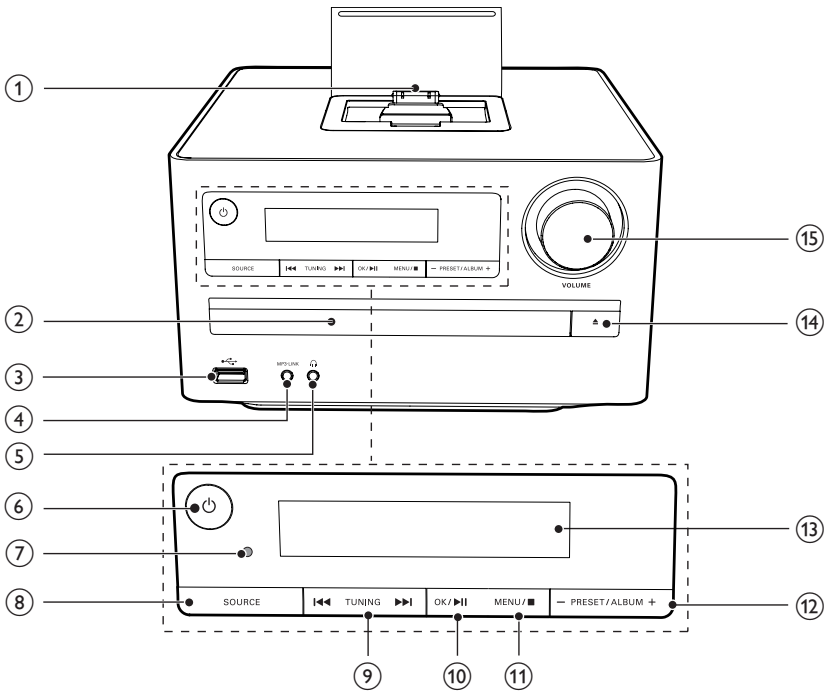

① Dock for iPod/iPhone/iPad

② Disc compartment

③  USB socket.

④ MP3-LINK  
• Connect an external audio device.

⑤  Headphone socket.

⑥   
• Turn on the product.  
• Switch to eco-power standby mode or normal standby mode.

⑦ IR sensor  
• Receive signals from the remote control.

⑧ SOURCE  
• Select a source.

⑨   
• Skip to the previous or next track.  
• Press and hold to search within a track/disc.  
• Tune to a radio station.

⑩   
• Start, pause, or resume play.  
• In DAB or FM mode, confirm the menu option.  
• In FM mode and with no menu option displayed, switch the sound mode between stereo and monophonic.



- ⑪ **MENU / ■**
- Stop the play of music.
  - Press twice to erase a program.
  - In normal standby mode, turn on or off feature demonstration.
  - In DAB or FM mode, access the menu.
  - Access the playlist of iPod/iPhone.
- ⑫ **- PRESET/ALBUM+**
- Skip to the previous or next album.
  - Select a preset radio station.
  - Navigate through iPod/iPhone/iPad menu.
- ⑬ **Display panel**
- Display current status.
- ⑭ **▲**
- Eject or close the disc tray.
- ⑮ **VOLUME**
- Adjust the volume level or time.

## 3 Before use

### Place the product

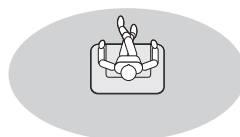

Place the speakers at an angle of approximately 45 degrees from the listening position.

#### Note

- To avoid magnetic interference or unwanted noise, never place this product too close to any radiation devices.

### Connect speakers

#### Note

- Make sure that the colors of the speaker wires and terminals are matched.
- For optimal sound, use the supplied speakers only.
- Connect only speakers with impedance that is the same or higher than the supplied speakers. Refer to the chapter "**Specifications**" in this manual.

- 1 Hold down the socket flap.
- 2 Insert the stripped part of the wire completely.
  - Insert the right speaker wires to "R", left speaker wires to "L".
  - Insert the red wires to "+", black wires to "-".

3 Release the socket flap.

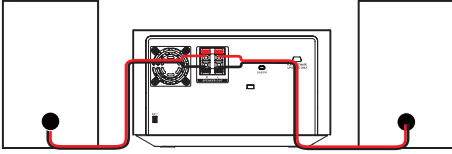

## Connect power



### Caution

- Risk of product damage! Make sure that the power supply voltage corresponds to the voltage printed on the back or the underside of the product.
- Risk of electric shock! When you unplug the AC power cord, always pull the plug from the socket. Never pull the cord.
- Before you connect the AC power cord, make sure that you have completed all other connections.

Connect the power plug to the wall outlet.

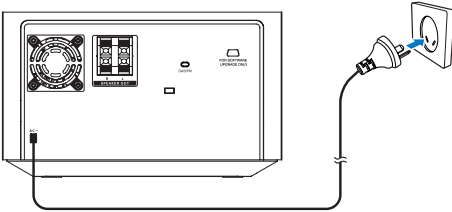

## Install/replace the remote control batteries



### Caution

- Risk of explosion! Keep batteries away from heat, sunshine, or fire. Never discard batteries in fire.

1 Open the battery compartment.

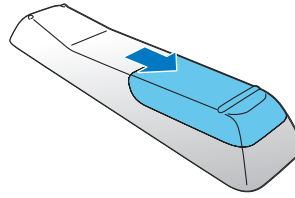

2 Insert 2 AAA batteries with correct polarity (+/-) as indicated.

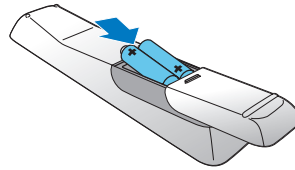

3 Close the battery compartment.

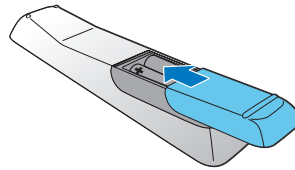

### Note

- If you are not going to use the remote control for a long time, remove the batteries.
- Do not use old and new or different types of batteries in combination.
- Batteries contain chemical substances, so dispose of them properly.

# 4 Get started



## Caution

- Use of controls or adjustments or performance of procedures other than herein may result in hazardous radiation exposure or other unsafe operation.

Always follow the instructions in this chapter in sequence.

---

## Turn on

Press .

- ↳ This product switches to the last selected source.



---

## Switch modes

### Automatically switch the modes:

- After this product keeps inactive for 15 minutes, it automatically switches to the normal standby mode.
- After this product keeps in the normal standby mode for 15 minutes, it automatically switches to the eco power standby mode.

### Manually switch the modes:

- Press and hold  to switch this product:
  - from the working mode or normal standby mode to the eco power standby mode.
  - from the eco power standby mode to the normal standby mode.
- Press  to switch this product
  - between the working mode and a standby mode.









## Note

- When an iPod/iPhone/iPad is connected, this product does not switch to the eco-power standby mode.

---

## Set clock

- 1 In standby mode, press and hold **PROG/CLOCK SET** to activate clock setting.
  - ↳ **[CLOCK SET]** (set clock) scrolls on the display, and then **[CLOCK 24]** (24-hour time format) is displayed with "24" blinking.
- 2 Press  /  or **VOL +/-** to select **[CLOCK 24]** or **[CLOCK 12]** (12-hour time format), and then press **PROG/CLOCK SET**.
  - ↳ The hour digits begin to blink.
- 3 Press  /  or **VOL +/-** to set the hour.
- 4 Press **PROG/CLOCK SET** again.
  - ↳ The minute digits begin to blink.
- 5 Press  /  or **VOL +/-** to set the minute.
- 6 Press **PROG/CLOCK SET** to confirm the clock setting.
  - ↳ The set clock is displayed.
    - To exit clock setting without storing, press .



## Note

- If no button is pressed in 90 seconds, the system exits clock setting mode automatically.



## Tip

- To adjust the digits of hour or minute, you can also turn the **VOLUME** knob or press **PRESET/ALBUM +/-** on the main unit.

---

## Demonstrate features

- 1 In normal standby mode, press 
  - **[WELCOME TO PHILIPS]** (welcome to Philips) scrolls on the display, and then feature names one by one.
- 2 To exit the feature demonstration, press  again.

# 5 Play

## Play a disc



### Caution

- Risk of damage to the product! During play, never move the product.
- Never put any object other than a disc into the disc compartment.
- Never look at the laser beam inside the player.
- Never play discs with accessories such as disc stabilizer rings or disc treatment sheets.

- 1 Press **CD** to select the disc source.
- 2 Load a disc.
  - 1) Press **▲** to eject the disc tray.
  - 2) Place a disc onto the disc tray with its label facing up.
  - 3) Press **▲** to close the disc compartment.
- 3 Press **▶||** if the play does not start automatically.

## Play from a USB storage device

This product can play files that are copied onto a supported USB storage device:

- flash drive
- memory card reader
- HDD (This product can only detect a portable hard disc drive with the peak current no higher than 500 mA through the USB socket.)



### Note

- Philips does not guarantee compatibility with all USB devices.
- NTFS (New Technology File System) data format is not supported.

- 1 Connect the USB storage device into the **↔ (USB)** socket.
- 2 Press **USB** to select the USB source.  
↳ Play starts automatically.

If the play does not start automatically,

- 1 Press **PRESET/ALBUM ▲ / ▼** to select a folder.
- 2 Press **◀◀ / ▶▶** to select a file.
- 3 Press **▶||** to start the play.

## Basic control

Buttons	Actions
<b>▶  </b>	Start, pause, or resume play.
<b>■</b>	Stop play.
<b>◀◀ / ▶▶</b>	Skip to the previous or next file.
<b>◀◀◀ / ▶▶▶</b>	Press and hold to rewind or search forward.
<b>MODE/SCAN</b>	Select a play mode: normal play, repeat, or shuffle.
<b>RDS/DISPLAY</b>	Display the current status and media information.

## Program audio tracks

- 1 Press **■** to stop the play.
- 2 Press **PROG/CLOCK SET**.  
↳ **[PRG]** blinks on the display panel.
- 3 Press **◀◀ / ▶▶** to select a track number.
- 4 Press **PROG/CLOCK SET**.
- 5 Repeat steps 3 and 4 to program more tracks.
- 6 Press **▶||** to play the programmed tracks.
  - To erase the program, press **■** twice.

## Note

- The programmed tracks must be stored on the same disc or USB storage device.
- You can program a maximum of 20 tracks.

## Adjust sound

During play, you can adjust the volume level and sound effect through following operations.

Button	Function
<b>VOL +/-</b>	Increase or decrease the volume.
<b>⏸</b>	Mute or restore sound.
<b>DBB</b>	Turn on or off the dynamic bass enhancement (DBB). <ul style="list-style-type: none"><li>• If DBB is activated, <b>[DBB]</b> is displayed.</li></ul>
<b>DSC</b>	Select a sound effect: <b>[POP]</b> (pop), <b>[JAZZ]</b> (jazz), <b>[ROCK]</b> (rock), <b>[CLASSIC]</b> (classic), or <b>[FLAT]</b> (flat).

## 6 Play from iPod/iPod/iPhone/iPad

You can enjoy audio from iPod/iPhone/iPad through this product.

## Note

- No audio output from the headphone socket in this situation.

## Compatible iPod/iPhone/iPad

This product supports the following iPod, iPhone and iPad models.

- iPad 2
- iPad
- iPhone 4
- iPhone 3GS
- iPhone 3G
- iPhone
- iPod touch (1st, 2nd, 3rd, and 4th generation)
- iPod nano (1st, 2nd, 3rd, 4th, 5th, and 6th generation)
- iPod classic
- iPod with video
- iPod with color display
- iPod mini

## Load the iPod/iPhone/iPad

## Note

- The peak current through the dock connector is limited as 1000 mA for iPod/iPhone and 2100 mA for iPad/iPad 2. To avoid damage to your iPod/iPhone/iPad and this product, securely load your iPod/iPhone/iPad as indicated.

- 1 Push the lock key to release the dock lid.

- 2 Insert your iPod/iPhone/iPad onto the dock.

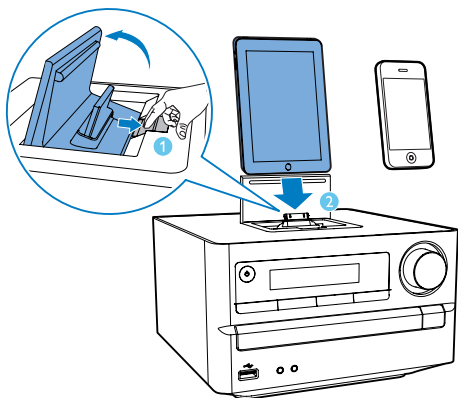

## Install the rubber bumper

### Note

- If your iPad 2 is not in a case, use the supplied rubber bumper to keep it stable.

- 1 Release the dock lid, and then place the rubber bumper onto the dock compartment.

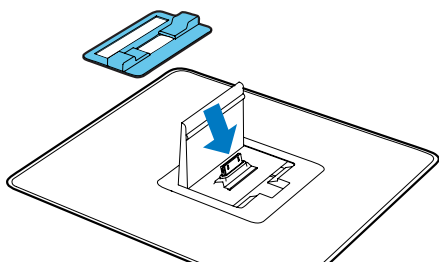

- 2 Load your iPad 2.

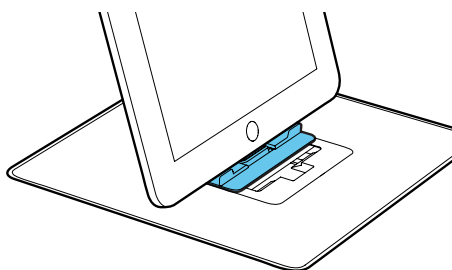

## Charge the iPod/iPhone/iPad

When the product is connected to power, the docked iPod/iPhone/iPad starts charging automatically.

### Tip

- For certain iPod models, it may take up to a minute before the charging indication appears.

## Listen to the iPod/iPhone/iPad

- 1 Press **DOCK** to select the iPod/iPhone/iPad source.
- 2 Select and play a track on your iPod/iPhone/iPad.
  - To pause or resume the play, press **▶||**.
  - To skip to the previous or next track, press **◀◀ / ▶▶**.
  - To search during play, press and hold **◀◀ / ▶▶**, and then release it to resume normal play.
  - To access the playlist of iPod/iPhone, press **Menu/■**.
  - To access the playlist of iPad/iPad 2, operate on the iPad/iPad 2 screen.
  - To scroll through the playlist, press **▲ / ▼**.
  - To confirm an option, press **OK** on the remote control.

## Remove the iPod/iPhone/iPad

- 1 Pull the iPod/iPhone/iPad out of the dock.
- 2 Flip down the lid to hide the dock.

# 7 Listen to radio



## Note

- For optimal reception, fully extend the antenna and adjust its position, or connect an outdoor antenna.
- This product does not support MW (medium wave) radio reception.
- You can program a maximum of 30 DAB radio stations and 30 FM radio stations.
- Check with local retailer or go to [www.WorldDAB.org](http://www.WorldDAB.org) for the applicable DAB radio frequencies in your area.
- Refer to "Product information" > "RDS program types" for more information about RDS radio stations.

## Store DAB radio stations automatically

If no DAB radio station is stored, this product can search and store DAB radio stations automatically.

- 1 Press **DAB/FM** repeatedly to switch to the DAB mode.
  - ↳ **[FULL SCAN]** is displayed.
- 2 Press **▶||** or **OK** to start the auto installation.
  - ↳ This product automatically stores radio stations with sufficient signal strength.
  - ↳ After all available radio stations are stored, the first stored radio station is broadcast automatically.

## Basic operations

Follow the instructions below for more functions.

**Tune to the next FM radio station with sufficient signal strength at the lower/higher frequency:**

Press and hold **◀◀ / ▶▶** to start the auto search.

**Tune to the FM radio station at a specific frequency:**

Press **◀◀ / ▶▶** repeatedly until the frequency digitals are displayed.

**Program FM radio stations automatically:**

Press and hold **MODE/SCAN** or **PROG/CLOCK SET** to start the auto programming.

**Program DAB radio stations automatically:**

Press and hold **MODE/SCAN** to start the auto programming.

**Program radio stations manually:**

- 1) Tune to a radio station.
- 2) Press **PROG/CLOCK SET** to activate the programming.
- 3) Press **▲ / ▼** to assign a sequence number to the radio station.
- 4) Press **PROG/CLOCK SET** to confirm.
- 5) Repeat steps 1-4 to program more radio stations.

**Tune to a preset radio station:**

Press **▲ / ▼** repeatedly.

**Switch the audio mode between [STEREO] (stereo) and [MONO] (monophonic) for FM radio:**

Press **OK** repeatedly.

**Display available information about the current radio station:**

Press **RDS/DISPLAY** repeatedly.

**Synchronize the clock with an RDS radio station:**

- 1) Tune to an RDS radio station that transmits time signals.
- 2) Press and hold **RDS/DISPLAY** until **[CT SYNC]** is displayed.

---

## Use the menu

When you listen to radio, you can access the menu for control options.

- 1 Press **MENU/■**.
  - ↳ FM mode: **[SCAN SETTINGS]** is displayed.
  - ↳ DAB mode: **[STATION]** is displayed.
- 2 Press **◀◀/▶▶** to select a menu option, and then press **OK** or **▶▶** to confirm the option or enter the lower-level menu.

### FM mode:

---

<b>[SCAN SETTINGS]</b>	Search and store radio stations automatically: <b>[STRONG]</b> for radio stations with strong signal only, <b>[ALL]</b> for all radio stations.
<b>[AUDIO]</b>	Select a sound mode: <b>[STEREO]</b> or <b>[MONO]</b> .
<b>[SYSTEM]</b>	<b>[RESET]</b> : Reset all radio settings to the factory default status. <b>[SW VER]</b> : Display the current version of the firmware. <b>[UPGRADE]</b> : Upgrade the firmware.

---

### DAB mode:

---

<b>[STATION]</b>	Access the list of the previously stored DAB radio stations. <ul style="list-style-type: none"><li>• Press <b>◀◀/▶▶</b> to select a station, and then <b>▶▶</b> to start listening.</li></ul>
<b>[FULL SCAN]</b>	Scan and store DAB radio stations within full range.
<b>[MANUAL]</b>	Tune to a DAB radio station manually.
<b>[DRC]</b>	Dynamic range control: Select a level for the effect of dynamic range control.
<b>[SYSTEM]</b>	<b>[RESET]</b> : Reset all radio settings to the factory default status. <b>[SW VER]</b> : Display the version of the current firmware. <b>[UPGRADE]</b> : Upgrade the firmware.

---

- 3 Press **MENU/■** to exit the menu.



## 8 Other features

### Set sleep timer

In working mode, press **SLEEP/TIMER** repeatedly to select a set period (in minutes).

- ↳ When sleep timer is activated, **zZ** is displayed.
- To deactivate sleep timer, press **SLEEP/TIMER** again until **zZ** disappears.

### Set alarm timer

This product can be used as an alarm clock. You can select CD, iPod/iPhone/iPad library, PHILIPS playlist, FM/DAB, or USB as alarm source.



#### Note

- Make sure that you have set the clock correctly.

- 1 In standby mode, press and hold **SLEEP/TIMER** until **[TIMER SET]** (set the timer) scrolls on the display.
  - ↳ **[SELECT SOURCE]** (select a source) scrolls on the screen.
- 2 Press **VOL +/-**, **SOURCE**, or **PRESET/ALBUM +/-** repeatedly to select a source: CD, USB, FM, DAB, iPod/iPhone/iPad library, or PHILIPS playlist.
- 3 Press **SLEEP/TIMER** to confirm.
  - ↳ The hour digits are displayed and begin to blink.
- 4 Press **▲ / ▼** or **VOL +/-** repeatedly to set hour, and then press **SLEEP/TIMER**.
  - ↳ The minute digits are displayed and begin to blink.

- 5 Press **▲ / ▼** or **VOL +/-** to set minute, and then press **SLEEP/TIMER** again.
  - ↳ **[VOL]** (volume) is displayed and begins to blink.
- 6 Press **▲ / ▼** or **VOL +/-** to adjust volume, and then press **SLEEP/TIMER** to confirm.
  - ↳ **⌘** is displayed.
    - To deactivate/activate the alarm timer, press **SLEEP/TIMER** repeatedly in normal standby mode.



#### Note

- When the alarm sounds, you can press **VOL +/-** to adjust volume.
- The alarm timer is not available in MP3 LINK mode.
- To use iPod/iPhone/iPad playlist as the alarm source, create a playlist named "PHILIPS" in your iPod/iPhone/iPad first.
- If no playlist named "PHILIPS" exists in the iPod/iPhone/iPad or the playlist includes no playable track, this product switches the alarm source to iPod/iPhone/iPad library.
- If other alarm sources are unavailable, this product switches to FM mode automatically.

### Listen to external audio device

You can listen to an external audio device, for example, MP3 player through this product.

- 1 Press **MP3 LINK/USB** repeatedly to select MP3 link source.
- 2 Connect the MP3 Link cable to
  - the **MP3-LINK** socket in the front panel of the main unit
  - the headphone socket on the external device.
- 3 Start to play the external device. (See the device user manual).

---

## Listen through headphone

Plug a headphone into the  socket in the front panel of the main unit.



### Note

- No audio output from the headphone socket when you listen to the docked iPod/iPhone/iPad. Listen through the speakers instead.

## 9 Upgrade the firmware



### Note

- Power supply must not be interrupted during the upgrade.
- The firmware upgrade can only be available through the mini-USB port on the back plate.
- When the firmware upgrade succeeds, all settings are restored to the factory default status.

---

## Register your product

- 1 Go to [www.philips.com/welcome](http://www.philips.com/welcome).
- 2 Click the link of "**Register my product**" (the exact wording of this link name may vary in different languages).
- 3 Login with your account on the prompt Web page.
  - If you have no account for Club Philips, create one first on this Web page.
- 4 Search your product with "**DCB2020/79**" as the keywords.
- 5 Click the link of search result to access the Web page for registering your product.
- 6 Fill in necessary information about this product to complete the registration.
  - ↳ With the registration, you can get information about software update and product support at this website or via your mailbox that is registered as the account for Club Philips.

---

## Check the current firmware version

Follow the steps to check the current version of firmware on your product.

- 1 Press **DAB/FM** to switch to radio mode.
- 2 Press **MENU/■** to access the menu.
- 3 Press **◀◀ / ▶▶** to select **[SYSTEM]**.
- 4 Press **OK** or **▶▶**.
- 5 Press **◀◀ / ▶▶** to select **[SW VER]**.
- 6 Press **OK** or **▶▶**.
  - ↳ The version of current firmware scrolls on the display panel

---

## Perform the upgrade

- 1 Go to [www.philips.com/welcome](http://www.philips.com/welcome).
- 2 Login with your account for Club Philips.
  - ↳ Support information about your registered product is displayed.
- 3 Click the link of "**Firmware Upgrade Readme File**" (the exact wording of this link name may vary in different languages).
- 4 Read and understand the instructions on firmware upgrade.
- 5 Follow the instructions to download the upgrade packet and complete the upgrade.
  - If the upgrade fails, reconnect the power supply, turn on this product, and perform the upgrade again.

# 10 Product information

### Note

- Product information is subject to change without prior notice.

---

## Specifications

### Amplifier

Rated Output Power	2 x 10 W RMS
Frequency Response	40 Hz-20 kHz, ±3 dB
Signal to Noise Ratio	> 77 dB
MP3-Link Input	600 mV RMS 22 kohm

### Disc

Laser Type	Semiconductor
Disc Diameter	12 cm/8 cm
Support Disc	CD-DA, CD-R, CD-RW, MP3-CD, WMA-CD
Audio DAC	24 Bits / 44.1 kHz
Total Harmonic Distortion	<0.8% (1 kHz)
Frequency Response	4 Hz - 20 kHz (44.1 kHz)
S/N Ratio	>75 dBA

---

## Tuner (FM)

Tuning Range	87.5 - 108 MHz
Tuning grid	50 KHz
Sensitivity	
- Mono, 26dB S/N Ratio	< 22 dBf
- Stereo, 46dB S/N Ratio	< 43 dBf
Search Selectivity	> 28 dBf
Total Harmonic Distortion	< 2%
Signal to Noise Ratio	> 55 dB

---

## DAB Tuner

Tuning Range	174–240 MHz (Band III)
Sensitivity	> 90 dBf

---

## Speakers

Speaker Impedance	6 ohm
Speaker Driver	10 cm full range
Sensitivity	> 84 dB/m/W $\pm$ 4 dB/m/W

---

## General information

AC power	220-240 V ~, 50/60 Hz
Operation Power Consumption	25 W
Power Consumption in Eco-power Standby	$\leq$ 0.5 W
Headphone Output	<150 mV
Wide Band Characteristic Voltage	>75 mV
USB Direct	Version 2.0 HS
Dimensions	
- Main Unit (W x H x D)	200 x 118 x 210 mm
- Speaker Box (W x H x D)	140 x 224 x 144 mm
Weight	
- Main Unit	1.35 kg
- Speaker Box	1.05 kg x 2

---

## USB playability information

### Compatible USB devices:

- USB flash memory (USB 2.0 or USB1.1)
- USB flash players (USB 2.0 or USB1.1)
- memory cards (requires an additional card reader to work with this product)

### Supported formats:

- USB or memory file format FAT12, FAT16, FAT32 (sector size: 512 bytes)
- MP3 bitrate (data rate): 32-320 Kbps and variable bitrate
- WMA v9 or earlier
- Directory nesting up to a maximum of 8 levels
- Number of albums/folders: maximum 99
- Number of tracks/files: maximum 999
- ID3 tag v2.0 or later
- File name in Unicode UTF8 (maximum length: 64 bytes)

### Unsupported formats:

- Empty albums: an album that does not contain MP3/WMA files
- Unsupported file formats are skipped. For example, Word documents (.doc) or MP3 files with extension .dlf are ignored and not played.
- AAC, WAV, PCM audio files
- DRM protected WMA files (.wav, .m4a, .m4p, mp4, aac)
- WMA files in Lossless format

---

## Supported MP3 disc formats

- ISO9660, Joliet
- Maximum track/file number: 999 (depending on file name length)
- Maximum album number: 99
- Supported sampling frequencies: 32 kHz, 44.1 kHz, 48 kHz
- Supported bitrates: 32-320 kbps, variable bitrates

---

## RDS program types

---

NO TYPE	No RDS programme type
NEWS	News services
AFFAIRS	Politics and current affairs
INFO	Special information programs
SPORT	Sports
EDUCATE	Education and advanced training
DRAMA	Radio plays and literature
CULTURE	Culture, religion and society
SCIENCE	Science
VARIED	Entertainment programs
POP M	Pop music
ROCK M	Rock music
MOR M	Light music
LIGHT M	Light classical music
CLASSICS	Classical music
OTHER M	Special music programs
WEATHER	Weather
FINANCE	Finance
CHILDREN	Children's programs
<hr/>	
SOCIAL	Social Affairs
RELIGION	Religion
PHONE IN	Phone In
TRAVEL	Travel
LEISURE	Leisure
JAZZ	Jazz Music
COUNTRY	Country Music
NATION M	National Music
OLDIES	Oldies Music
FOLK M	Folk Music
DOCUMENT	Documentary
TES	Alarm Test
ALARM	Alarm

---

# 11 Troubleshooting



## Warning

- Never remove the casing of this apparatus.

To keep the warranty valid, never try to repair the product yourself.

If you encounter problems when using this product, check the following points before requesting service. If the problem remains unsolved, go to the Philips Web page ([www.philips.com/welcome](http://www.philips.com/welcome)). When you contact Philips, make sure that the product is nearby and the model number and serial number are available.

Problem	Solution
No power	Make sure that the AC power cord is connected properly.
	Make sure that there is power at the AC outlet.
	With a power-saving feature, the system switches off automatically 15 minutes after the product stays inactivity.
No sound or poor sound	Adjust the volume.
	Disconnect the headphones.
	Make sure that the speakers are connected correctly.
No response from the product	Make sure that the stripped speaker wires are clamped.
	Reconnect the AC power plug, and then turn on the product again.
	With a power-saving feature, the system switches off automatically 15 minutes after the product stays inactivity.
Remote control does not work	Before you press any function button, select the correct source with the remote control instead of the main unit.
	Reduce the distance between the remote control and the main unit.
	Insert each battery with its polarity (+/- signs) aligned as indicated.
	Replace the batteries.
No disc detected	Aim the remote control directly at the sensor on the front panel of the main unit.
	Insert a disc.
	Make sure that you place the disc with its label facing upwards.
	Wait until the moisture condensation at the lens has cleared.
USB storage device not supported	Replace or clean the disc.
	Make sure that the recordable disc is finalized and the format supported.
	Try another one.
Cannot play some files on the USB storage device	Make sure that the file format is supported.
	Make sure that the file quantity does not exceed the maximum.

Problem	Solution
Poor radio reception	Increase the distance between the product and other electrical appliances.
	Fully extend the antenna.
	Connect an outdoor FM/DAB antenna instead.
Timer does not work	Set the clock correctly.
	Switch on the timer.
Clock/timer setting erased	Power has been interrupted or the AC power cord has been disconnected.
	Reset the clock/timer.

**Philips Electronics Australia Limited and Philips New Zealand Limited  
Warranty against Defects**

In this warranty:

**We or us** means Philips Electronics Australia Limited ACN 008 445 743 or Philips New Zealand Limited (Company Number 1723), and our contact details are set out at the end of this warranty;

**You** means the purchaser or the original end-user of the Goods;

**Supplier** means the authorised distributor or retailer of the Goods that sold you the Goods in Australia or New Zealand; and

**Goods** means the product or equipment which was accompanied by this warranty and purchased in Australia or New Zealand.

If you require assistance with the operation of the product, its features or specifications please call the Philips Consumer Care Centre on 1300 363 391 in Australia or 0800 658 224 in New Zealand.

**Australia:** Our Goods come with guarantees that cannot be excluded under the Australian Consumer Law. You are entitled to a replacement or refund for a major failure and for compensation for any other reasonably foreseeable loss or damage. You are also entitled to have the Goods repaired or replaced if the goods fail to be of acceptable quality and the failure does not amount to a major failure. This is not a complete statement of your legal rights as a consumer.

**New Zealand:** Our Goods come with guarantees that cannot be excluded under the Consumer Guarantees Act 1993. This guarantee applies in addition to the conditions and guarantees implied by that legislation.

**Additional Warranty:**

In addition to the rights and remedies that you have under the Australian Consumer Law, Consumer Guarantees Act of New Zealand or any other applicable law, we provide the following warranty against defects:

1. If, during the first 12 months from their date of purchase from the Supplier (**Warranty Period**), the Goods prove defective by reason of improper workmanship or materials and none of your statutory rights or remedies apply, we will repair or replace the Goods without charge.
2. We do not have to repair or replace the Goods under this Additional Warranty if the Goods have been used for a commercial purpose; misused, improperly or inappropriately installed, operated or repaired; abused; damaged; or not maintained in accordance with the manufacturer's instructions.
3. Even when we do not have to repair or replace the Goods, we may decide to do so anyway. In some cases, we may decide to substitute the Goods with a similar alternative product of our choosing. All such decisions are at our absolute discretion.
4. All such repaired, replaced or substituted Goods continue to receive the benefit of this Additional Warranty for the time remaining on the original Warranty Period.
5. This Additional Warranty is limited to repair, replacement or substitution only. As far as the law permits, we will not be liable for any loss or damage caused to property or persons arising from any cause whatsoever.
6. In order to claim under this Additional Warranty you must telephone us on 1300 363 391 in Australia or 0800 658 224 in New Zealand within the Warranty Period. You will be asked for details of the Goods, a description of the defect and your personal details. Upon accepting your claim, we shall assist you with either returning the Goods to the Supplier for replacement or to the most convenient Philips Authorised Service Centre for your Goods to be repaired. In some case we may require that you return to the Goods to us (at the address below) for repair, replacement or substitution.
  - \* All returned Goods must be accompanied by satisfactory proof of purchase which clearly indicates the name and address of the Supplier, the date and place of purchase and identifies product. It is best to provide a legible and unmodified receipt or sales invoice.
  - \* You must bear any expense for return of the Goods or otherwise associated with making your claim under this Additional Warranty.
7. This warranty is only valid and enforceable in Australia and New Zealand.

Contact us or the place of purchase for further details.

Philips Electronics Australia Limited  
Level 1, 65 Epping Rd,  
North Ryde, SYDNEY NSW 2113  
**Consumer Care:** 1300 363 391  
**E-mail:** [pceinfo.australia@philips.com](mailto:pceinfo.australia@philips.com)  
**Website:** [www.philips.com/support](http://www.philips.com/support)

Philips New Zealand Limited  
Level 2, 1 Nugent St,  
Grafton, AUCKLAND, 1023  
**Consumer Care:** 0800 658 224  
**Email:** [pceinfo.australia@philips.com](mailto:pceinfo.australia@philips.com)  
**Website:** [www.philips.com/support](http://www.philips.com/support)





Specifications are subject to change without notice  
© 2012 Koninklijke Philips Electronics N.V.  
All rights reserved.

DCB2020\_79\_UM\_V1.0

