



Quick start guide

CD170/CD175

PHILIPS

What's in the box



Handset*



Base station (CD175)

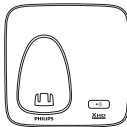

Base station (CD170)



Charger*



Power adapter*



Line cord**



User manual
Quick start guide
Guarantee

Note

- * In multi-handset packs, there are additional handsets, chargers and power adapters.
- ** In some countries, you have to connect the line adapter to the line cord, then plug the line cord to the telephone socket.

Caution

- Use only the supplied batteries and power adapter.

1 Connect

Connect the base station

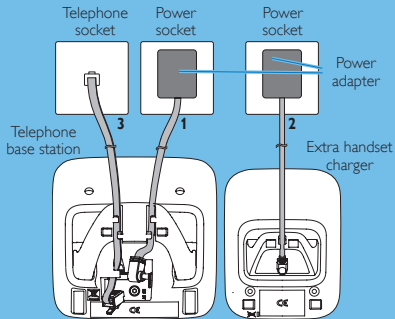

- 1 Connect each end of the power adapter to:
 - the DC input jack at the bottom of the base station;
 - the power socket on the wall.
- 2 Connect each end of the power adapter to (for multi-handset packs):
 - the DC input jack at the bottom of the extra handset charger;
 - the power socket on the wall.
- 3 Connect each end of the line cord to:
 - the telephone socket at the bottom of the base station;
 - the telephone socket on the wall.

2 Install

Install the handset

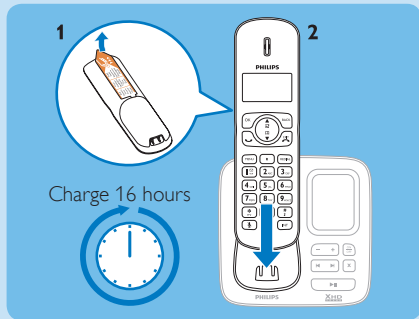

- 1 The batteries are pre-installed in the handset. Pull the battery tape off from the battery door before charging.
- 2 Place the handset on the base station to charge the handset. When the handset is placed correctly on the base station, you hear the docking sound.
↳ The handset starts charging.

Note Charge the batteries for 16 hours before first use.

Configure your phone (if necessary)

- 1 When you see the welcome message, press **OK**.
- 2 Select your country, press **OK** to confirm.
- 3 Set the date and time.
 - ↳ If the time is in 12-hour format, press  key to select **[AM]** or **[PM]**.
 - ↳ The phone is now ready to use.

Check the battery level

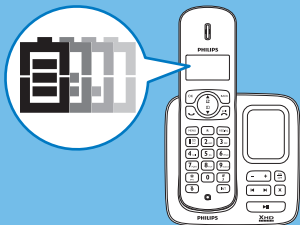



When the handset is off the base station/charger, the bars indicate the battery level (full, medium and low). When the handset is on the base station/charger, the bars keep scrolling until charging completes.





The empty battery icon flashes and you hear an alert tone.
The battery is low and needs recharging.

3 Enjoy

Call

- To make a call, press  and dial the phone number.
- To answer a call, press  when the phone rings.
- To end a call, press .

Adjust the earpiece volume

Press  or  to adjust the volume during a call.

Add a contact in the phonebook

- 1 Press **MENU**.
- 2 Select **[PHONEBOOK]** > **[NEW ENTRY]**, then press **OK** to confirm.
- 3 Enter the name then press **OK** to confirm.
- 4 Enter the number, then press **OK** to confirm.

Record an announcement (for CD175 only)

- 1 Press **MENU**.
- 2 Select **[ANSW MACHINE]** > **[ANNOUNCEMENT]**, then press **OK** to confirm.
- 3 Select **[ANSW.&RECORD]** or **[ANSWER ONLY]**, then press **OK** to confirm.
- 4 Select **[RECORD]**, then press **OK** to confirm.
- 5 When **[RECORDING]** displays, start recording close to the microphone.
- 6 Press **OK** to stop recording.
↳ You can listen to the newly recorded announcement on the handset.

Listen to messages recorded on the answering machine (for CD175 only)

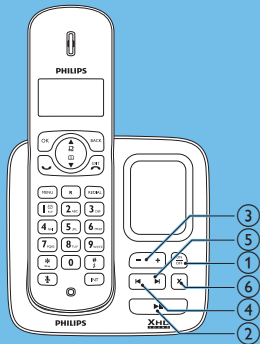

- ① Switch on/off the answering machine: Press **ON/OFF**.
- ② Start/Stop listening to the recorded messages: Press **▶■**.
- ③ Adjust the volume: Press **+ / -**.
- ④ Skip backward:
When you listen to the messages, press **◀** to listen to the message from the beginning.
During the first second of the current message, press **◀** to listen to the previous message.
- ⑤ Skip forward: Press **▶** to skip to the next message.
- ⑥ Delete the current message: Press **X**.

Note For more information, see the Telephone answering machine section in the user manual.

Welcome to Philips

Register your product at www.philips.com/welcome

Need help?

User Manual

Refer to the user manual that came with your new phone.

Online help

www.philips.com/support



Reproduction in whole or in part is prohibited without the written consent of the copyright owner. Trademarks are the property of Koninklijke Philips Electronics N.V. or their respective owners. © 2009 Koninklijke Philips Electronics N.V. All rights reserved.



CE 0168

Printed in China

QSG_CD170-175_05_EN_V1.5
WK9482