

Register your product and get support at
www.philips.com/welcome

DCM278



EN	User manual	3
DA	Brugervejledning	19
DE	Benutzerhandbuch	35
ES	Manual del usuario	53

FR	Mode d'emploi	71
IT	Manuale utente	89
NL	Gebruiksaanwijzing	107
SV	Användarhandbok	125

PHILIPS

Contents

1 Important	4
Safety	4
Notice	5

2 Your Micro Hi-Fi System	6
Introduction	6
What's in the box	6
Overview of the main unit	7
Overview of the remote control	8

3 Get started	9
Placement	9
Prepare the remote control	9
Connect power	10
Auto install radio stations	10
Set clock	10
Turn on	11

4 Play	11
Play a disc	11
Play from USB	11
Play options	12

5 Play iPod/iPhone	13
Compatible iPod/iPhone	13
Play an iPod/iPhone player	13
Charge the iPod/iPhone	13

6 Listen to radio	14
Tune to a radio station	14
Program radio stations automatically	14
Program radio stations manually	14
Select a preset radio station	14
FM stations with RDS	14

7 Other features	15
Set the alarm timer	15
Set the sleep timer	15
Play from an external device	15

8 Adjust sound	16
Adjust volume level	16
Mute sound	16
Select a preset sound effect	16
Enhance bass	16

9 Product information	16
Specifications	16
USB playability information	17
Supported MP3 disc formats	17
Maintenance	17

10 Troubleshooting	18
---------------------------	----

1 Important

Safety

- ① Read these instructions.
- ② Keep these instructions.
- ③ Heed all warnings.
- ④ Follow all instructions.
- ⑤ Do not use this apparatus near water.
- ⑥ Clean only with dry cloth.
- ⑦ Do not block any ventilation openings. Install in accordance with the manufacturer's instructions.
- ⑧ Do not install near any heat sources such as radiators, heat registers, stoves, or other apparatus (including amplifiers) that produce heat.
- ⑨ Protect the power cord from being walked on or pinched, particularly at plugs, convenience receptacles, and the point where they exit from the apparatus.
- ⑩ Only use attachments/accessories specified by the manufacturer.
- ⑪ Use only with the cart, stand, tripod, bracket, or table specified by the manufacturer or sold with the apparatus. When a cart is used, use caution when moving the cart/apparatus combination to avoid injury from tip-over.
- ⑫ Unplug this apparatus during lightning storms or when unused for long periods of time.
- ⑬ Refer all servicing to qualified service personnel. Servicing is required when the apparatus has been damaged in any



way, such as power-supply cord or plug is damaged, liquid has been spilled or objects have fallen into the apparatus, the apparatus has been exposed to rain or moisture, does not operate normally, or has been dropped.

- ⑭ **Battery usage CAUTION** – To prevent battery leakage which may result in bodily injury, property damage, or damage to the unit:
 - Install all batteries correctly, + and - as marked on the unit.
 - Do not mix batteries (old and new or carbon and alkaline, etc.).
 - Remove batteries when the unit is not used for a long time.
- ⑮ Apparatus shall not be exposed to dripping or splashing.
- ⑯ Do not place any sources of danger on the apparatus (e.g. liquid filled objects, lighted candles).
- ⑰ Where the MAINS plug or an appliance coupler is used as the disconnect device, the disconnect device shall remain readily operable.



Warning

- Never remove the casing of this apparatus.
- Never lubricate any part of this apparatus.
- Never place this apparatus on other electrical equipment.
- Keep this apparatus away from direct sunlight, naked flames or heat.
- Never look into the laser beam inside this apparatus.
- Ensure that you always have easy access to the power cord, plug or adaptor to disconnect this apparatus from the power.

Hearing safety

Listen at a moderate volume.

- Using headphones at a high volume can impair your hearing. This product can produce sounds in decibel ranges that may cause hearing loss for a normal person, even for exposure less than a minute. The higher decibel ranges are offered for those that may have already experienced some hearing loss.
- Sound can be deceiving. Over time your hearing 'comfort level' adapts to higher volumes of sound. So after prolonged listening, what sounds 'normal' can actually be loud and harmful to your hearing. To guard against this, set your volume to a safe level before your hearing adapts and leave it there.

To establish a safe volume level:

- Set your volume control at a low setting.
- Slowly increase the sound until you can hear it comfortably and clearly, without distortion.

Listen for reasonable periods of time:

- Prolonged exposure to sound, even at normally 'safe' levels, can also cause hearing loss.
- Be sure to use your equipment reasonably and take appropriate breaks.

Be sure to observe the following guidelines when using your headphones.

- Listen at reasonable volumes for reasonable periods of time.
- Be careful not to adjust the volume as your hearing adapts.
- Do not turn up the volume so high that you can't hear what's around you.
- You should use caution or temporarily discontinue use in potentially hazardous situations. Do not use headphones while operating a motorized vehicle, cycling, skateboarding, etc.; it may create a traffic hazard and is illegal in many areas.

Notice

Any changes or modifications made to this device that are not expressly approved by Philips Consumer Lifestyle may void the user's authority to operate the equipment.

This product complies with the radio interference requirements of the European Community.



Your product is designed and manufactured with high quality materials and components, which can be recycled and reused.



When this crossed-out wheeled bin symbol is attached to a product it means that the product is covered by the European Directive 2002/96/EC.



Please inform yourself about the local separate collection system for electrical and electronic products.

Please act according to your local rules and do not dispose of your old products with your normal household waste. Correct disposal of your old product helps to prevent potential negative consequences for the environment and human health.

Your product contains batteries covered by the European Directive 2006/66/EC, which cannot be disposed with normal household



waste. Please inform yourself about the local rules on separate collection of batteries because correct disposal helps to prevent negative consequences for the environmental and human health.

Environmental information

All unnecessary packaging has been omitted. We have tried to make the packaging easy to separate into three materials: cardboard (box), polystyrene foam (buffer) and polyethylene (bags, protective foam sheet.)

Your system consists of materials which can be recycled and reused if disassembled by a specialized company. Please observe the local regulations regarding the disposal of

packaging materials, exhausted batteries and old equipment.



Windows Media and the Windows logo are trademarks, or registered trademarks of Microsoft Corporation in the United States and/or other countries.

This apparatus includes this label:



Norge

Typeskilt finnes på apparatens underside.

Observer: Nettbryteren er sekundert innkopleet. Den innebygde nettdelen er derfor ikke frakopleet nettet så lenge apparatet er tilsluttet nettkontakten.

For å redusere faren for brann eller elektrisk støt, skal apparatet ikke utsettes for regn eller fuktighet.

2 Your Micro Hi-Fi System

Congratulations on your purchase, and welcome to Philips! To fully benefit from the support that Philips offers, register your product at www.philips.com/welcome.

Introduction

With this unit, you can enjoy audio from discs, USB devices, iPod players, iPhone and other external devices, or listen to radio stations. The unit offers Digital Sound Control (DSC) and Dynamic Bass Boost (DBB) to enrich sound.

The unit supports the following media formats:



What's in the box

Check and identify the contents of your package:

- Main unit
- Remote control
- 1 x MP3 link cable
- Mounting kit (2 dowels and 2 screws)
- Quick start guide
- User manual
- Wall mounting instructions

Overview of the main unit

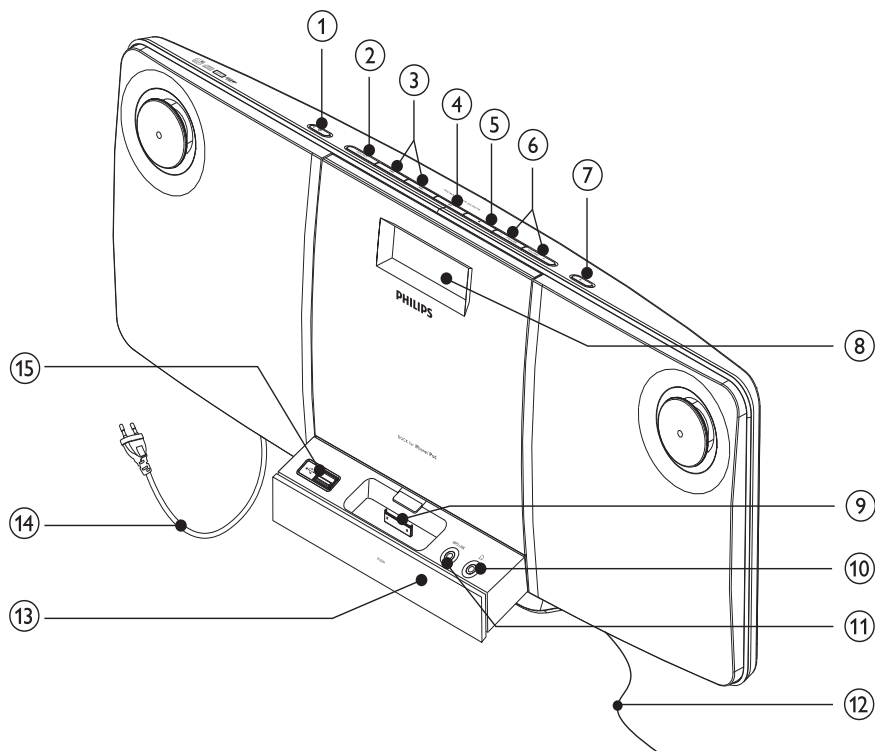



- ① **⏻**
- Turn on the unit, or switch to standby mode, or switch to Eco Power standby.
- ② **SOURCE**
- Select a source: CD, FM tuner, USB, iPod, or MP3 link.
- ③ **⏮⏭**
- Skip to the previous/next track.
 - Search within a track.
 - Tune to a radio station.
 - Select 12 hour or 24 hour format.
- ④ **▶⏸**
- Start or pause play.
- ⑤ **■**
- Stop play or erase a program.
- ⑥ **VOLUME + / -**
- Adjust volume.
- ⑦ **⏪**
- Open/close the disc compartment.
- ⑧ **Display panel**
- Show current status.
- ⑨ **Dock for iPod/iPhone**
- ⑩ **🎧**
- Jack for the headphone.
- ⑪ **MP3 LINK**
- Audio input jack (3.5mm) for an external audio device.
- ⑫ **FM antenna**
- Improve FM reception.

- ⑬ Remote sensor
- ⑭ AC cord
- ⑮ 
 - Jack for a USB mass storage device.

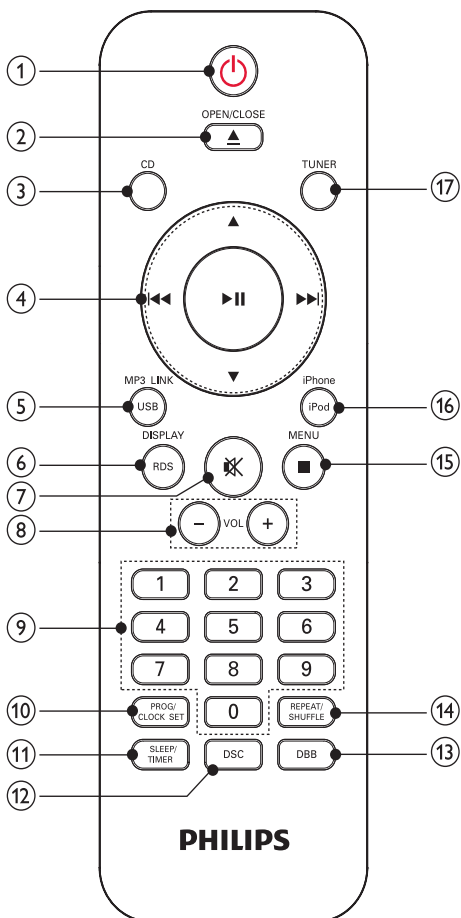
Overview of the remote control



- ① 
 - Turn on the unit, or switch to standby mode, or switch to Eco Power standby.

- ② **OPEN/CLOSE▲**
 - Open or close the disc compartment.
- ③ **CD**
 - Select disc source.
- ④ **▲/▼**
 - Navigate in the iPod menu.
 - Skip to the previous/next album.
- ◀◀▶▶**
 - Skip to the previous/next track.
 - Search within a track.
 - Tune to a radio station.
 - Select 12 hour or 24 hour format.
- ⏸**
 - Start or pause play.
- ⑤ **USB/MP3 LINK**
 - Select USB device source.
 - Select external audio device source.
- ⑥ **RDS/DISPLAY**
 - For selected FM radio stations: display RDS information.
 - Select display information during play.
- ⑦ 
 - Mute or restore volume.
- ⑧ **VOL +/-**
 - Adjust volume.
- ⑨ **Numeric keypad**
 - Select a track from a disc directly.
- ⑩ **PROG/CLOCK SET**
 - Program tracks.
 - Program radio stations.
 - Set the clock.
- ⑪ **SLEEP/TIMER**
 - Set the sleep timer.
 - Set the alarm timer.
- ⑫ **DSC**
 - Select a preset sound setting.
- ⑬ **DBB**
 - Turn on or off dynamic bass enhancement.

- ⑭ **REPEAT/SHUFFLE**
- Play a track or all tracks repeatedly.
 - Play tracks randomly.
- ⑮ **■/MENU**
- Stop play or erase a program.
 - Access the iPod menu.
- ⑯ **iPod/iPhone**
- Select iPod/iPhone source.
- ⑰ **TUNER**
- Select tuner source.

3 Get started

! Caution

- Use of controls or adjustments or performance of procedures other than herein may result in hazardous radiation exposure or other unsafe operation.

Always follow the instructions in this chapter in sequence.

If you contact Philips, you will be asked for the model and serial number of this apparatus. The model number and serial number are on the rear of the apparatus. Write the numbers here:

Model No. _____

Serial No. _____

Placement

You can place the unit on a flat surface or mount the unit on a wall.

Mount on a wall

To wall mount the unit, see the included separate sheet of wall mounting instructions.

Prepare the remote control

! Caution

- Risk of explosion! Keep batteries away from heat, sunshine or fire. Never discard batteries in fire.

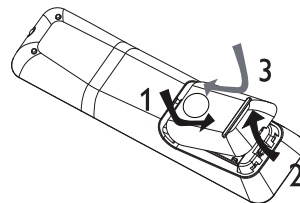

- 1 Open the battery compartment.
- 2 Insert 2 AAA batteries with correct polarity (+/-) as indicated.
- 3 Close the battery compartment.

Note

- If you are not going to use the remote control for a long time, remove the batteries.
- Do not use old and new or different types of batteries in combination.
- Batteries contain chemical substances, so they should be disposed of properly.

Connect power

Caution

- Risk of product damage! Ensure that the power supply voltage corresponds to the voltage printed on the bottom of the unit.
- Before connecting the AC cord, ensure you have completed all other connections.

Note

- The type plate is located on the rear of the main unit.

- 1 Connect the AC cord to the AC outlet.

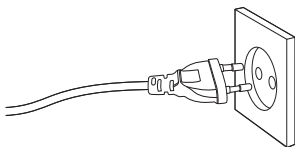

Auto install radio stations

When you connect power and no radio stations are stored, the unit automatically begins to store radio stations.

- 1 Connect the unit to the power supply.
 - ↳ [AUTO INSTALL - PRESS PLAY KEY](auto install - press play key) is displayed.
- 2 Press **▶||** on the main unit to start installation.
 - ↳ The unit automatically stores radio stations with sufficient signal strength.
 - ↳ When all the available radio stations are stored, the first preset radio station is broadcast automatically.

Set clock

Note

- You can set the clock in the standby mode only.

- 1 Press **PROG/CLOCK SET** to enter the clock setting mode.
 - ↳ [SET CLOCK](set clock) scrolls on the screen.
- 2 Press **◀▶▶▶** repeatedly to select 12 hour or 24 hour format.
- 3 Press **PROG/CLOCK SET** to confirm.
 - ↳ The hour digits are displayed and begin to blink.
- 4 Press **◀▶▶▶** to set the hour.
- 5 Press **PROG/CLOCK SET** to confirm.
 - ↳ The minute digits are displayed and begin to blink.
- 6 Press **◀▶▶▶** to set the minute.
- 7 Press **PROG/CLOCK SET** to confirm the clock setting.

Turn on

- 1 Press **⏻**.
↳ The unit switches to the last selected source.

Switch to standby

- 1 Press **⏻** again to switch the unit to standby mode.
↳ The clock (if set) appears on the display panel.

To switch the unit to Eco Power Standby mode:

- 1 In the standby mode, press and hold **⏻** for more than 2 seconds.
↳ The backlight on the display panel turns off.

4 Play

Play a disc

- 1 Press **CD** to select the disc source.
- 2 Press **▲** to open the disc compartment.
- 3 Insert a disc with the printed side facing outward.
- 4 Press **▲** to close the disc compartment.
↳ Play starts automatically. If not, press **▶||**.

Play from USB



Note

- Ensure that the USB device contains playable audio content.

- 1 Insert the USB device into the  socket.

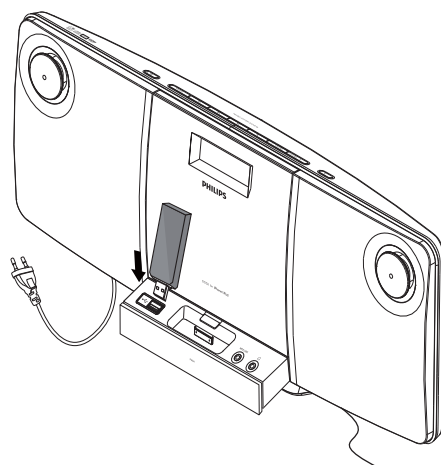

- 2 Press **USB/MP3 LINK** to select the USB source.
 - ↳ Play starts automatically. If not, press **▶||**.
 - To select a folder, press **▲/▼**.
 - To select an audio file, press **◀◀▶▶**.

Play options

Pause/resume play

- 1 During play, press **▶||** to pause/resume play.

Skip to a track

For CD:

- 1 Press **◀◀▶▶** to select another track.
 - To select a track directly, you can also press a key on the numerical keypad.

For MP3 disc and USB:

- 1 Press **▲▼** to select an album or a folder.
- 2 Press **◀◀▶▶** to select a track or a file.

Search within a track

- 1 During play, press and hold **◀◀▶▶**.
- 2 Release to resume normal play.

Select repeat/shuffle play options

- 1 During play, press **REPEAT/SHUFFLE** repeatedly to select a repeat option or the shuffle play mode.
 - **[↻]**: the current track is played repeatedly.
 - **[↻ALL]**: all tracks are played repeatedly.
 - **[🔀]**: all tracks are played randomly.
- 2 To resume normal play, press **REPEAT/SHUFFLE** repeatedly until no option is displayed.

Program tracks



Note

- You can program tracks only when the play stops.

You can program a maximum of 40 tracks.

- 1 Press **PROG/CLOCK SET** to activate the program mode.
 - ↳ **[PROG]** (program) is displayed.
- 2 For MP3/WMA tracks, press **▲/▼** to select an album.
- 3 Press **◀◀▶▶** to select a track, then press **PROG/CLOCK SET** to confirm.
- 4 Repeat steps 2 to 3 to program more tracks.
- 5 Press **▶||** to play the programmed tracks.
 - ↳ During play, **[PROG]** (program) is displayed.
 - To erase the program, in the stop position, press **■**.

5 Play iPod/iPhone

You can enjoy audio from iPod/iPhone through this Micro Hi-Fi system.

Compatible iPod/iPhone

Apple iPod and iPhone models with a 30-pin dock connector:

- iPod classic, iPod touch, iPod nano, iPod 5th generation (video), iPod with color display, iPod mini
- iPhone, iPhone 3G, iPhone 3GS

Play an iPod/iPhone player

- 1 Place the iPod/iPhone player in the dock.

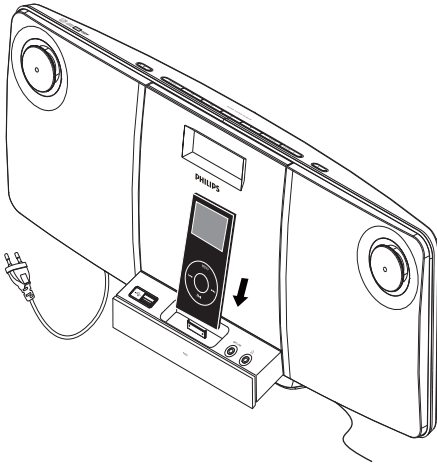

- 2 Press **iPod** to select iPod source.
 - ↳ The connected iPod/iPhone plays automatically.
 - To pause/resume play, press **▶||**.
 - To skip to a track, press **◀◀▶▶**.
 - To search during play, press and hold **◀◀▶▶**, then release to resume normal play.

Charge the iPod/iPhone

When the unit is connected to power, the docked iPod/iPhone begins to charge.

6 Listen to radio

Tune to a radio station

- 1 Press **TUNER** to select FM.
- 2 Press and hold **◀▶▶▶** for more than 2 seconds.
 - ↳ **[SEARCH]** (search) is displayed.
 - ↳ The radio tunes to a station with strong reception automatically.
- 3 Repeat step 2 to tune to more stations.
 - To tune to a weak station, press **◀▶▶** repeatedly until you find optimal reception.

Program radio stations automatically

You can program a maximum of 20 preset radio stations (FM).

- 1 In the tuner mode, press and hold **PROG/CLOCK SET** for more than 2 seconds to activate automatic program mode.
 - ↳ **[AUTO]** (auto) is displayed.
 - ↳ All available stations are programmed in the order of waveband reception strength.
 - ↳ The first programmed radio station is broadcast automatically.

Program radio stations manually

You can program a maximum of 20 preset radio stations (FM).

- 1 Tune to a radio station.
- 2 Press **PROG/CLOCK SET** to activate program mode.
 - ↳ **[PROG]** (program) is displayed.

- 3 Press **▲/▼** to allocate a number to this radio station, then press **PROG/CLOCK SET** to confirm.
- 4 Repeat the above steps to program other stations.



- To overwrite a programmed station, store another station in its place.

Select a preset radio station

- 1 In tuner mode, press **▲/▼** to select a preset number.



- Position the antenna as far as possible from TV, VCR or other radiation source.
- For optimal reception, fully extend and adjust the position of the antenna.

FM stations with RDS

Radio Data System (RDS) is a service that sends additional broadcast information along with FM stations.

If you listen to a FM station with RDS signal, "RDS" is displayed.

Display RDS information

- 1 For an FM station with RDS, press **RDS/DISPLAY** repeatedly to display various broadcast information.







7 Other features

Set the alarm timer

This unit can be used as an alarm clock. The disc/radio/USB/iPod is activated to play at a preset time.

Note

- Ensure that you have set the clock correctly.

- 1 Press  to switch to standby mode.
- 2 Press and hold **SLEEP/TIMER** for more than two seconds.
 - ↳ A prompt to select the source is displayed.
- 3 Press **CD**, **TUNER**, **USB** or **iPod** to select a source.
- 4 Press **SLEEP/TIMER** to confirm.
 - ↳ The clock digits are displayed.
 - ↳ The hour digits begin to blink.
- 5 Press   to set the hour.
- 6 Press **SLEEP/TIMER** to confirm.
 - ↳ The minute digits begin to blink.
- 7 Press   to set the minute.
 - ↳ The timer is set and activated.
 - ↳  is displayed.

To deactivate alarm timer

- 1 Press **SLEEP/TIMER** again.
 - ↳ When alarm timer is deactivated,  disappears on the display.

Set the sleep timer

This unit can switch to standby automatically after a set period of time.

- 1 When the unit is turned on, press **SLEEP/TIMER** repeatedly to select a set period of time (in minutes).
 - ↳ When sleep timer is activated, **zz** is displayed.

To deactivate sleep timer

- 1 Press **SLEEP/TIMER** repeatedly until **[OFF]** (off) is displayed.
 - ↳ When sleep timer is deactivated, **zz** disappears on the display.

Play from an external device

You can also listen to an external audio device through this unit.

- 1 Press **USB/MP3 LINK** to select the MP3 link source.
- 2 Connect the supplied MP3 link cable to:
 - the **MP3 LINK** jack (3.5mm) on the unit.
 - the headphone jack on an external device.
- 3 Start to play the device (see the device user manual).

8 Adjust sound

Adjust volume level

- 1 During play, press **VOL +/-** to increase/decrease the volume level.

Mute sound

- 1 During play, press **M** to mute/unmute sound.

Select a preset sound effect

- 1 During play, press **DSC** repeatedly to select:
 - **[POP]** (pop)
 - **[JAZZ]** (jazz)
 - **[ROCK]** (rock)
 - **[CLASSIC]** (classic)
 - **[FLAT]** (flat)

Enhance bass

- 1 During play, press **DBB** to turn on or off dynamic bass enhancement.
↳ If DBB is activated, **[DBB]** is displayed.

9 Product information



Note

- Product information is subject to change without prior notice.

Specifications

Amplifier

Total output power	2 x 5 W RMS
Frequency response	80 Hz - 16 kHz, \pm 3 dB
Signal to noise ratio	> 60 dB
MP3 link input	0.5 V RMS 20 k Ω

Disc

Laser type	Semiconductor
Disc diameter	12 cm /8 cm
Support disc	CD-DA, CD-R, CD-RW, MP3-CD, WMA-CD
Audio DAC	24 Bits / 44.1 kHz
Total harmonic distortion	< 1.5%
Frequency response	60 Hz -16 kHz (44.1 kHz)
Signal to noise ratio	> 75 dBA

Tuner

Tuning range	FM: 87.5 - 108 MHz
Tuning grid	50 KHz
Number of presets	20

Speakers

Speaker driver	3" woofer
Speaker impedance	5 W, 8 Ω

General information

AC power	220 - 230V, 50 Hz
Operation Power Consumption	35 W
Standby Power Consumption	< 2 W
Eco Power Standby Power Consumption	< 1 W
USB Direct	Version 2.0/1.1
Dimensions	
- Main Unit (W x H x D)	542 x 238 x 102 mm
Weight	
- Main Unit	3.935 kg

USB playability information

Compatible USB devices:

- USB flash memory (USB 2.0 or USB 1.1)
- USB flash players (USB 2.0 or USB 1.1)
- memory cards (requires an additional card reader to work with this unit)

Supported formats:

- USB or memory file format FAT12, FAT16, FAT32 (sector size: 512 bytes)
- MP3 bit rate (data rate): 32-320 Kbps and variable bit rate
- WMA v9 or earlier
- Directory nesting up to a maximum of 8 levels
- Number of albums/ folders: maximum 99
- Number of tracks/titles: maximum 999
- ID3 tag v2.0 or later
- File name in Unicode UTF8 (maximum length: 128 bytes)

Unsupported formats:

- Empty albums: an empty album is an album that does not contain MP3/WMA files, and is not be shown in the display.
- Unsupported file formats are skipped. For example, Word documents (.doc) or MP3 files with extension .dlf are ignored and not played.

- AAC, WAV, PCM audio files
- DRM protected WMA files (.wav, .m4a, .m4p, .mp4, .aac)
- WMA files in Lossless format

Supported MP3 disc formats

- ISO9660, Joliet
- Maximum title number: 999 (depending on file name length)
- Maximum album number: 99
- Supported sampling frequencies: 32 kHz, 44.1kHz, 48 kHz
- Supported Bit-rates: 32-320 (kbps), variable bit rates
- ID3 tag v2.0 or later
- Directory nesting up to a maximum of 8 levels

Maintenance

Clean the cabinet

- Use a soft cloth slightly moistened with a mild detergent solution. Do not use a solution containing alcohol, spirits, ammonia or abrasives.

Clean discs

- When a disc becomes dirty, clean it with a cleaning cloth. Wipe the disc from the centre out.
- Do not use solvents such as benzene, thinner, commercially available cleaners, or antistatic spray intended for analogue records.



Clean the disc lens

- After prolonged use, dirt or dust may accumulate at the disc lens. To ensure good play quality, clean the disc lens with Philips CD lens cleaner or any commercially available cleaner. Follow the instructions supplied with cleaner.

10 Troubleshooting



Warning

- Never remove the casing of this apparatus.

To keep the warranty valid, never try to repair the system yourself.

If you encounter problems when using this apparatus, check the following points before requesting service. If the problem remains unsolved, go to the Philips web site www.philips.com/welcome. When you contact Philips, ensure that the apparatus is nearby and the model number and serial number are available.

No power

- Ensure that the AC power plug of the unit is connected properly.
- Ensure that there is power at the AC outlet.
- To save power, the unit switches to standby automatically 15 minutes after a play reaches the end and no control is operated.

No sound

- Adjust the volume.

No response from the unit

- Disconnect and reconnect the AC power plug, then turn on the unit again.

No disc detected

- Insert a disc.
- Check if the disc is inserted with the print side facing inward.
- Wait until the moisture condensation at the lens has cleared.
- Replace or clean the disc.
- Use a finalized CD or correct format disc.

Remote control does not work

- Before pressing any function button, first select the correct source with the remote control instead of the main unit.
- Reduce the distance between the remote control and the unit.
- Insert the battery with its polarities (+/- signs) aligned as indicated.
- Replace the battery.
- Aim the remote control directly at the sensor on the front of the unit.

Cannot display some files in USB device

- The number of folders or files in the USB device has exceeded a certain limit. This phenomenon is not a malfunction.
- The formats of these files are not supported.

USB device not supported

- The USB device is incompatible with the unit. Try another one.

Poor radio reception

- Increase the distance between the unit and your TV or VCR.
- Fully extend and adjust the FM antenna.

Clock/timer setting erased

- Power has been interrupted or the power cord has been disconnected.
- Reset the clock/timer.

Timer does not work

- Set the clock correctly.
- Switch on the timer.

