

Mini HiFi System

FWM15

User manual
Manuel d'utilisation
Manual del usuario
Benutzerhandücher
Gebruikershandleidingen
Manuale per l'utente
Användarhandböckerna
Brugermanual
Käyttöoppaita
Manual do usuário
εγχειρίδιο χρήσης



PHILIPS

Important notes for users in the U.K.

Mains plug

This apparatus is fitted with an approved 13 Amp plug. To change a fuse in this type of plug proceed as follows:

- 1 Remove fuse cover and fuse.
- 2 Fix new fuse which should be a BS1362 5 Amp, A.S.T.A. or BSI approved type.
- 3 Refit the fuse cover.

If the fitted plug is not suitable for your socket outlets, it should be cut off and an appropriate plug fitted in its place.

If the mains plug contains a fuse, this should have a value of 5 Amp. If a plug without a fuse is used, the fuse at the distribution board should not be greater than 5 Amp.

Note: The severed plug must be disposed of to avoid a possible shock hazard should it be inserted into a 13 Amp socket elsewhere.

How to connect a plug

The wires in the mains lead are coloured with the following code: blue = neutral (N), brown = live (L).

- As these colours may not correspond with the colour markings identifying the terminals in your plug, proceed as follows:
 - Connect the blue wire to the terminal marked N or coloured black.
 - Connect the brown wire to the terminal marked L or coloured red.
 - Do not connect either wire to the earth terminal in the plug, marked E (or ⏏) or coloured green (or green and yellow).

Before replacing the plug cover, make certain that the cord grip is clamped over the sheath of the lead - not simply over the two wires.

Copyright in the U.K.

Recording and playback of material may require consent. See Copyright Act 1956 and The Performer's Protection Acts 1958 to 1972.

Italia

DICHIARAZIONE DI CONFORMITA'

Si dichiara che l'apparecchio FWM15 Philips risponde alle prescrizioni dell'art. 2 comma 1 del D.M. 28 Agosto 1995 n. 548.

Fatto a Eindhoven

Philips Consumer Electronics
Philips, Glaslaan 2
5616 JB Eindhoven, The Netherlands

Norge

Typeskilt finnes på apparatens underside.

Observer: Nettbryteren er sekundert innkopleet. Den innebygde nettdelen er derfor ikke frakopleet nettet så lenge apparatet er tilsluttet nettkontakten.

For å redusere faren for brann eller elektrisk støt, skal apparatet ikke utsettes for regn eller fuktighet.

CAUTION

Use of controls or adjustments or performance of procedures other than herein may result in hazardous radiation exposure or other unsafe operation.

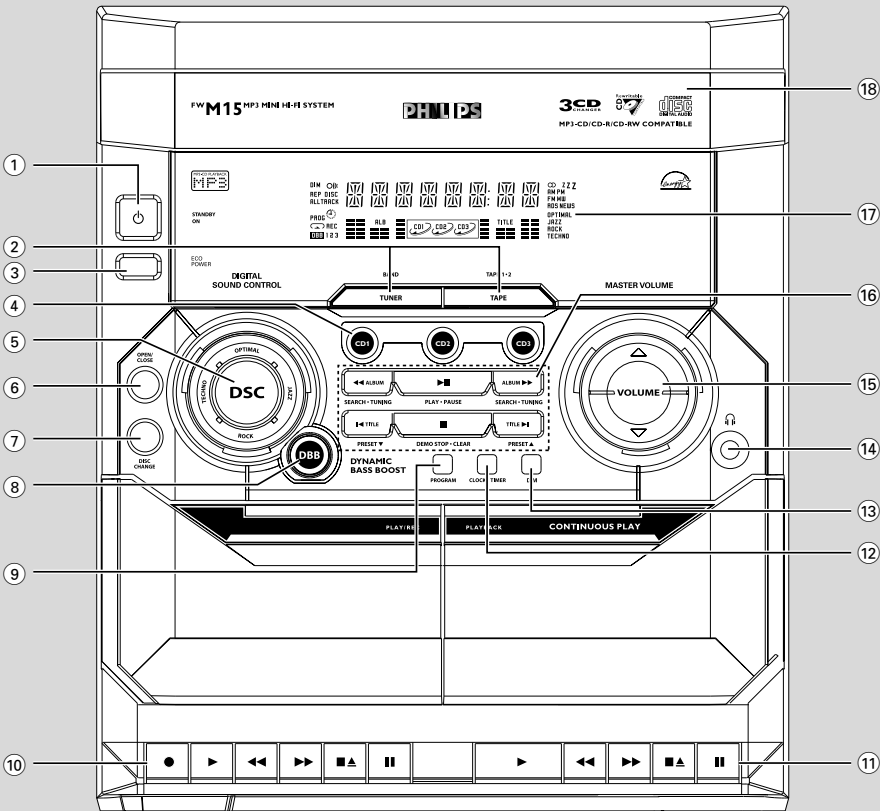
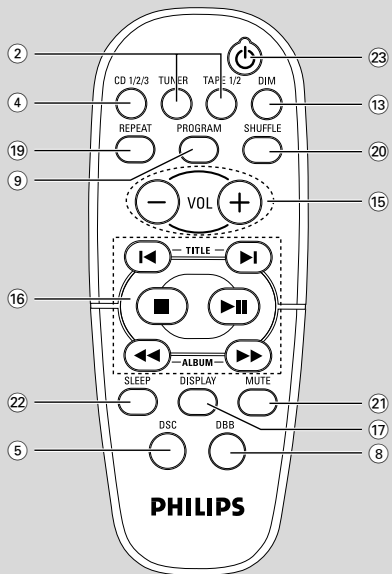

DK

Advarsel: Usynlig laserstråling ved åbning når sikkerhedsafbrydere er ude af funktion. Undgå udsættelse for stråling.

Bemærk: Netafbryderen er sekundært indkoblet og afbryder ikke strømmen fra nettet. Den indbyggede netdel er derfor tilsluttet til lysnettet så længe netstikket sidder i stikkontakten.

S

Klass 1 laseraparat

Varning! Om apparaten används på annat sätt än i denna bruksanvisning specificerats, kan användaren utsättas för osynlig laserstråling, som överskrider gränsen för laserklass 1.

Observera! Stömbrytaren är sekundärt kopplad och bryter inte strömmen från nätet. Den inbyggda nätdelen är därför ansluten till elnätet så länge stickproppen sitter i vägguttaget.

SF

Luokan 1 laserlaite

Varoitus! Laitteen käyttäminen muulla kuin tässä käyttöohjeessa mainitulla tavalla saattaa altistaa käyttäjän turvallisuusluokan 1 ylittävälle näkymättömälle lasersäteilylle.

Oikeus muutoksiin varataan. Laite ei saa olla alttiina tippu- ja roiskevedelle.

Huom. Toiminnanvalitsin on kytketty toisiopuolelle, eikä se kytke laitetta irti sähköverkosta. Sisäänrakennettu verkko-osa on kytkettynä sähköverkkoon aina silloin, kun pistoke on pistorasiassa.

DEMO MODE

To turn ON

Press & HOLD

DEMO STOP



button

for 5 seconds

To turn OFF

Press & HOLD

DEMO STOP



button

for 5 seconds

PLUG & PLAY

(for tuner installation)

1



Plug in the unit

2



Follow instructions
in the display

3



Press "PLAY"

English	6
Français	29
Español	52
Deutsch	75
Nederlands	98
Italiano	121
Svenska	144
Dansk	167
Suomi	190
Português	213
Ελληνικά	236

English

Français

Español

Deutsch

Nederlands

Italiano

Svenska

Dansk

Suomi

Português

Ελληνικά

Contents

General Information

Supplied accessories	7
Acknowledgement	7
Environmental information	7
Safety information	7

Preparations

Rear connections	8–9
Power	
Antennas connection	
Speakers connection	
Inserting batteries into the remote control	9

Controls

Controls on the system and remote control	10–11
---	-------

Basic Functions

Plug and Play	12
Demonstration mode	13
Switching the system on	13
Switching the system to standby mode	13
Switching the system to Eco Power standby mode (< 0.5 Watt)	13
Dim mode	13
Volume control	14
Sound control	14
DSC (Digital Sound Control)	
DBB (Dynamic Bass Boost)	

CD/MP3-CD Operations

Discs for playback	15
About MP3 disc	15–16
Loading discs	16
Playing discs	16
Replacing discs during playback	16
Selecting a desired track/passage	17
Selecting a desired Album/Title (MP3 disc only)	17
Repeat play	17
Random play	
Programming the disc tracks	17–18
Erasing the programme	18

Radio Reception

Tuning to radio stations	19
Storing preset radio stations	19–20
Automatic preset programming	
Manual preset programming	
Tuning to preset radio stations	20
Erasing a preset radio station	20

Tape Operation/Recording

Loading tape	21
Playing tapes	21
Rewinding/Fast forwarding	22
General information on recording	22
Preparation for recording	22
One touch recording	22
CD Synchronised start recording	23
Dubbing tapes	23

Clock/Timer

View clock	24
Clock setting	24
Timer setting	24–25
Deactivating the timer	
Activating the timer	
Sleep timer setting	25

Specifications

Maintenance

Troubleshooting

This product complies with the radio interference requirements of the European Community.

Supplied accessories

- 2 speaker boxes
- remote control
- MW loop antenna
- FM wire antenna

Acknowledgement

Energy Star

As an ENERGY STAR®

Partner, Philips has

determined that this product

meets the ENERGY STAR®

guidelines for energy efficiency.



Environmental information

All unnecessary packaging has been omitted.

We have tried to make the packaging easy to separate into three materials: cardboard (box), polystyrene foam (buffer) and polyethylene (bags, protective foam sheet).

Your system consists of materials which can be recycled and reused if disassembled by a specialised company. Please observe the local regulations regarding the disposal of packaging materials, exhausted batteries and old equipment.

Safety information

- Before operating the system, check that the operating voltage indicated on the typeplate (or the voltage indication beside the voltage selector) of your system is identical with the voltage of your local power supply. If not, please consult your dealer.
- Place the system on a flat, hard and stable surface.
- Place the system in a location with adequate ventilation to prevent internal heat build-up in your system. Allow at least 10 cm (4 inches) clearance from the rear and the top of the unit and 5 cm (2 inches) from each side.
- The ventilation should not be impeded by covering the ventilation openings with items, such as newspapers, table-cloths, curtains, etc.
- Do not expose the system, batteries or discs to excessive moisture, rain, sand or heat sources caused by heating equipment or direct sunlight.
- No naked flame sources, such as lighted candles, should be placed on the apparatus.
- No objects filled with liquids, such as vases, shall be placed on the apparatus.
- The lens may cloud over when the system is suddenly moved from cold to warm surroundings, making it impossible to play a disc. Leave the system in the warm environment until the moisture evaporates.
- The mechanical parts of the set contain self-lubricating bearings and must not be oiled or lubricated.
- **When the system is switched to Standby mode, it is still consuming some power. To disconnect the system from the power supply completely, remove the AC power plug from the wall socket.**

Preparations

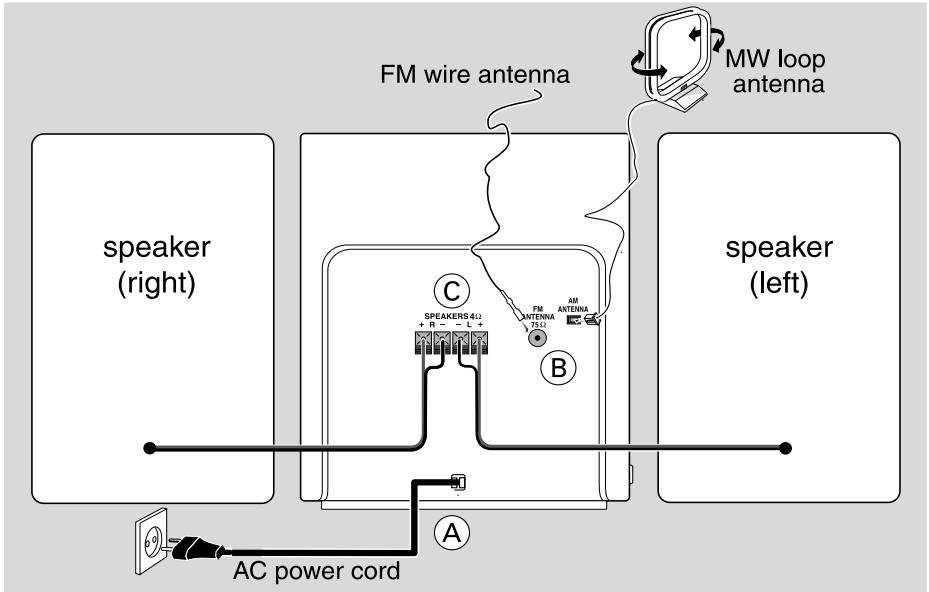

Rear connections

The type plate is located at the rear of the system.

For users in the U.K.: please follow the instructions on page 2.

(A) Power

Before connecting the AC power cord to the wall outlet, ensure that all other connections have been made.

WARNING!

- For optimal performance, use only the original power cable.
- Never make or change any connections with the power switched on.

(B) Antennas Connection

Connect the supplied AM loop antenna and FM antenna to the respective terminals. Adjust the position of the antenna for optimal reception.

MW Antenna

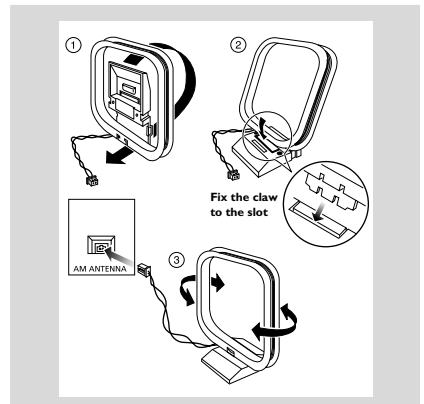

- Position the antenna as far as possible from a TV, VCR or other radiation source.

FM Antenna

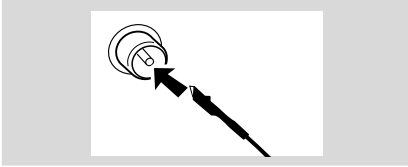

- For better FM stereo reception, connect an outdoor FM antenna to the FM ANTENNA terminal.

C Speakers Connection

Front Speakers

Connect the speaker wires to the SPEAKERS terminals, right speaker to "R" and left speaker to "L", coloured (marked) wire to "+" and black (unmarked) wire to "-".

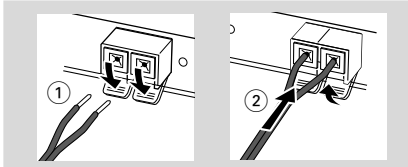

- Fully insert the stripped portion of the speaker wire into the terminal as shown.

Notes:

- For optimal sound performance, use the supplied speakers.
- Do not connect more than one speaker to any one pair of + / - speaker terminals.
- Do not connect speakers with impedance lower than the speakers supplied. Please refer to the SPECIFICATIONS section of this manual.

Inserting batteries into the remote control

Insert two batteries type R03 or AAA (not supplied) into the remote control with the correct polarity as indicated by the "+" and "-" symbols inside the battery compartment.

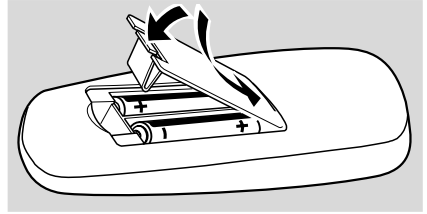

CAUTION!

- Remove batteries if they are exhausted or will not be used for a long time.
- Do not use old and new or different types of batteries in combination.
- Batteries contain chemical substances, so they should be disposed off properly.

Controls on the system and remote control

- ① **STANDBY ON** 
 - to switch the system on or to standby mode.
- ② **TUNER (BAND)**
 - to select waveband : FM or MW.
- TAPE (TAPE 1•2)**
 - to select tape mode.
- ③ **ECO POWER**
 - to switch the system on or to Eco Power standby mode.
- ④ **CD 1/ CD 2/ CD 3 (CD 1/2/3)**
 - to select disc tray 1, 2 or 3.
- ⑤ **DSC (DIGITAL SOUND CONTROL)**
 - to select the desired sound effect : JAZZ, ROCK, TECHNO or OPTIMAL.
- ⑥ **CD OPEN/CLOSE**
 - to open or close the disc tray.
- ⑦ **DISC CHANGE**
 - to change disc(s).
- ⑧ **DBB (DYNAMIC BASS BOOST)**
 - to select the desired bass boost level.
- ⑨ **PROGRAM**
 - for CD to programme disc tracks.
 - for Tuner to programme preset radio stations.
 - for Clock to select 12- or 24-hour clock mode.
- ⑩ **Tape deck 1 operation**
 - to start recording.
 - ▶ to start playback.
 - ◀◀ / ▶▶ to rewind or fast forward.
 - ▲ to stop playback/recording or to open the tape door.
 - || to interrupt playback or recording.

- ⑪ **Tape deck 2 operation**
 - ▶ to start playback.
 - ◀◀ / ▶▶ to rewind or fast forward.
 - ▲ to stop playback or to open the tape door.
 - || to interrupt playback.
- ⑫ **CLOCK•TIMER**
 - to view the clock, set the clock or set the timer.
- ⑬ **DIM**
 - to select different brightness for the display screen : DIM 1, DIM 2, DIM 3 or DIM OFF.
- ⑭ 
 - to connect headphones.
- ⑮ **MASTER VOLUME ▲▼ (VOL +/–)**
 - to increase or decrease the volume.
- ⑯ **Mode Selection**
 - PLAY•PAUSE ▶||**
 - for CD/MP3-CD... to start or interrupt playback.
 - for Plug & Play... (on the system only) to initiate and start plug & play mode.
 - SEARCH•TUNING ◀◀ (ALBUM)**
 - for MP3-CD to select previous/next album.
 - SEARCH•TUNING ▶▶ (ALBUM)**
 - for CD to search backward/forward.
 - for Tuner to tune to a lower or higher radio frequency.
 - for Clock (on the system only) to set the hour.
 - STOP•CLEAR / DEMO STOP ■**
 - for CD/MP3-CD... to stop playback or to clear a programme.
 - for Tuner (on the system only) to stop programming or to erase a selected preset.
 - for Demo (on the system only) to activate/deactivate the demonstration.
 - for Clock (on the system only) to exit clock setting or cancel timer.
 - for Plug & Play... (on the system only) to exit plug & play mode.

PREV ◀ / PRESET ▼ (TITLE)

NEXT ▶ / PRESET ▲ (TITLE)

- for MP3-CD to select previous/next title.
- for CD to skip to the beginning of the, previous, or next track.
- for Tuner to select a preset radio station.
- for Clock (on the system only) to set the minute.

17 Display screen

- to view the current status of the system.

18 Disc tray

19 REPEAT

- to playback track(s)/disc(s)/programme repeatedly.

20 SHUFFLE

- to playback all available tracks/programme of the current disc in random order.

21 MUTE

- to interrupt or resume sound reproduction.

22 SLEEP

- to activate/deactivate or set the sleep timer.

23 ⏻

- to switch the system to standby mode.
- to switch the system to Eco Power standby mode.

Notes for remote control:

- **First, select the source you wish to control by pressing one of the source select keys on the remote control (CD 1/2/3 or TUNER, for example).**
- **Then select the desired function (▶, ◀, ▶, for example).**

Basic Functions

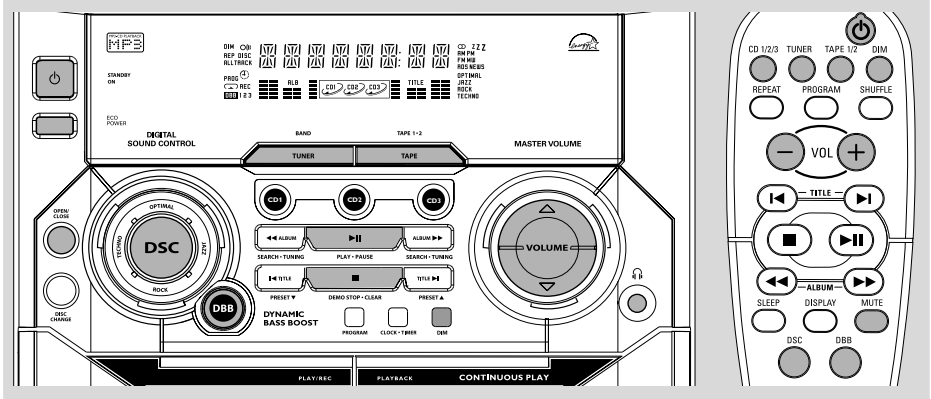

IMPORTANT!

Before you operate the system, complete the preparation procedures.

Plug and Play (for tuner installation)

Plug and Play allows you to store all available radio stations automatically.

First time setup/power up

- 1 When you turn on the main supply, "AUTO INSTALL - PRESS PLAY" is displayed.
- 2 Press ►|| on the system to start installation.
→ "INSTALL" is displayed, followed by "TUNER" and "AUTO".
→ **PROG** starts flashing.
→ All available radio stations with sufficient signal strength will be stored automatically, starting from FM and followed by MW band.
→ When all the available radio stations are stored or the memory for 40 presets are used, the last preset radio station will be played.

To reinstall Plug and Play

- 1 In **standby** or **demonstration mode**, press and hold ►|| on the system until "AUTO INSTALL - PRESS PLAY" is displayed.
- 2 Press ►|| again to start installation.
→ All previously stored radio stations will be replaced.

To exit without storing the Plug and Play

- Press ■ on the system.
→ If you do not complete the Plug and Play installation, the function will be restarted when you next turn on the main supply again.

Notes:

- When the power is turned on, the disc tray may open and close to initialise the system.
- If no stereo frequency is detected during Plug and Play, "CHECK ANTENNA" will be displayed.
- During Plug and Play, if no button is pressed within 15 seconds, the system will exit Plug and Play mode.

Demonstration mode

The system has a demonstration mode that shows the various features offered by the system.

To activate the demonstration

- In **standby mode**, press and hold **■** on the system until "WELCOME" is displayed.
→ The demonstration will begin.

To deactivate the demonstration

- Press and hold **■** on the system until "DEMO OFF" is displayed.
→ The system will switch to standby mode.

Note:

– If you have not deactivated the demonstration, it will resume five seconds after the system switches to Eco Power standby or standby mode.

Switching the system on

In standby/demonstration mode

- Press **STANDBY ON** to switch on the last selected source.
- Press **CD 1/2/3**, **TUNER** or **TAPE (TAPE 1/2)**.
- Press **OPEN/CLOSE**.

In Eco Power standby mode

- Press **ECO POWER** to switch on the last selected source.
- Press **CD 1/2/3**, **TUNER** or **TAPE 1/2** on the remote control.

Switching the system to standby mode

In demonstration mode

- Press and hold **■** on the system.

In any other source mode (except Eco Power standby mode)

- Press **STANDBY ON** (or **⏻** on the remote control).
→ The clock will appear on the display when the system is in standby mode.

Switching the system to Eco Power standby mode (< 0.5 Watt)

- Press **ECO POWER** (or press and hold **⏻** on the remote control).
→ "ECO PWR" is displayed, then the display screen will go blank.
→ The low power ECO POWER LED will be lighted.

Dim mode

You can select the desired brightness for the display.

- In any source mode (except standby mode), press **DIM MODE** repeatedly to select : DIM 1, DIM 2, DIM 3 or DIM OFF.
→ **DIM** is shown, except for DIM OFF mode.

DIM mode	Brightness	Spectrum Analyser
1	normal	off
2	half	on
3	half	off
OFF	normal	on

Note:

– In standby mode, pressing **DIM MODE** to select half or full brightness for clock display.

Basic Functions

Volume control

Press **MASTER VOLUME ▲** or **▼ (VOL +** or **-** on the remote control) to increase or decrease the volume level.

To listen through the headphones

- Connect the headphones plug to the  socket at the front of the system.

→ The speakers will be muted.



To switch off the volume temporarily

- Press **MUTE** on the remote control.
→ Playback will continue without sound and "MUTE" is displayed.
- To restore the volume, press **MUTE** again or increase the volume level.

Sound control

DSC (Digital Sound Control)

The DSC feature enables you to enjoy special sound effects that have preset equaliser settings, providing the best music reproduction.

- Press **DSC** to select : JAZZ, ROCK, TECHNO or OPTIMAL.
→ The selected DSC is shown.

DBB (Dynamic Bass Boost)

There are three DBB settings to enhance the bass response.

- Press **DBB** repeatedly to select a bass boost level.
→ "DBB 1 (or 2/3)" and the respective bass boost level are shown.

To deactivate DBB

- Press **DBB** repeatedly until "DBB OFF" is displayed.

Note:

– Some discs or tapes might be recorded in high modulation, which causes a distortion at high volume. If this occurs, switch off DBB or reduce the volume.

Automatic DSC-DBB selection

The best DBB setting is generated automatically for each DSC selection. You can manually select the DBB setting that best suits your listening environment.

DSC	DBB
JAZZ	off
ROCK	on (3)
TECHNO	on (3)
OPTIMAL	on (2)

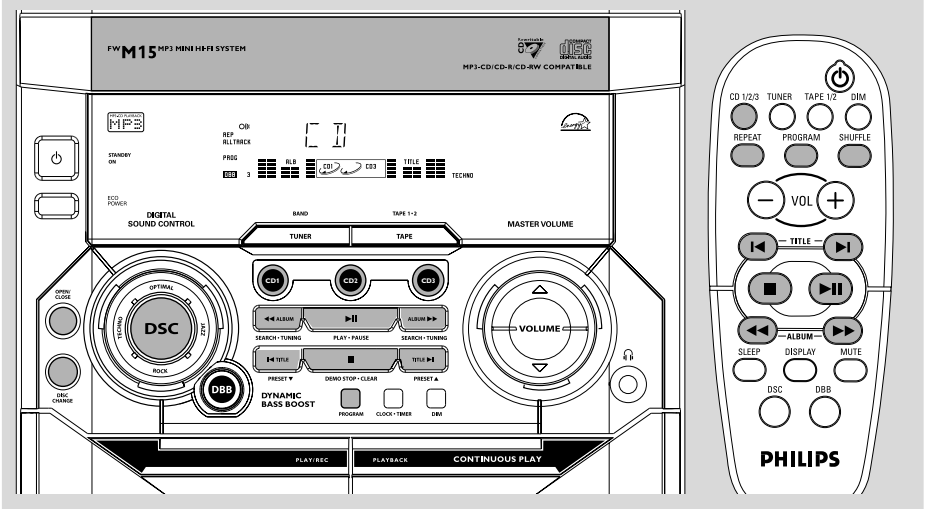

IMPORTANT!

- This system is designed for regular discs. Therefore, do not use any accessories such as disc stabiliser rings or disc treatment sheets, etc., as offered on the market, because they may jam the changer mechanism.
- Do not load more than one disc into each tray.

Discs for playback

This system is able to play :

- All pre-recorded audio CDs
- All finalised audio CDR and audio CDRW discs
- MP3-CDs (CD-ROMs with MP3 tracks)



About MP3 disc

Supported formats

- ISO9660, Joliet, Multisession
- Max. track number plus album is 255
- Max. nested directory is 8 levels
- The max. album number is 32
- The max. MP3 programme track number is 99
- Supported VBR bit-rate
- Supported sampling frequencies for MP3 disc are: 32 kHz, 44.1 kHz, 48 kHz
- Supported Bit-rates of MP3 disc are: 32, 64, 96, 128, 192, 256 (kbps)

Making your own MP3-CD

- 1 Rip the music from your own Digital Audio CDs or download legal MP3 music from the Internet.
- 2 Record ("burn") the music on CD-R(W) disc with your home PC. Make sure to use a recording speed not faster than indicated on the CD-R(W) and avoid running other programme simultaneously on your PC during the recording process.

CD/MP3-CD Operations

Sound Quality

Take note that MP3-CD compilations should best contain only MP3 tracks (*.mp3). **To achieve a good MP3 quality, a bit rate of 128 kbps is recommended.**

Loading discs

- 1 Press **OPEN/CLOSE** to open the disc tray.
- 2 Load up to two discs on the individual disc trays. To load the third disc, press **DISC CHANGE**.
→ The disc tray will rotate until the empty tray is ready for loading.

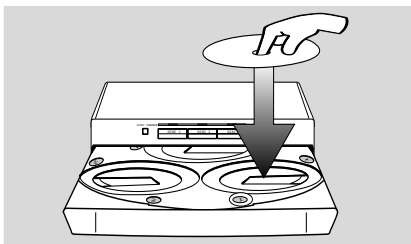

- 3 Press **OPEN/CLOSE** to close the disc tray.
→ "READING" is displayed. The selected disc tray, total number of tracks and the playing time will appear on the display.
→ For MP3 disc, the name of the first album will be scrolled through the display once and followed by "RXX TXXX".

Notes:

- Load the discs with the label side facing up.
- For MP3 disc, the disc reading time may exceed 10 seconds due to the large number of songs compiled into one disc.

Playing discs

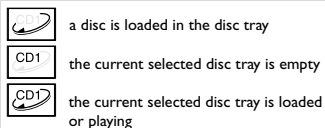

To play all discs on the disc tray

- Press **▶||**.
→ All the available discs will play once, then stop.
→ During playback, the selected disc tray, track number and elapsed playing time of the current track are displayed.
→ For MP3 disc, **TITLE** is shown. For mixed mode discs, only one mode will be selected for playback depending on the recording format.

To play the selected disc only

- In CD mode, press **CD 1**, **CD 2** or **CD 3** on the system.
→ The selected disc will play once, then stop.

To interrupt playback

- Press **▶||**.
→ The current track time flashes.
- To resume playback, press **▶||** again.

To stop playback

- Press **■**.

Replacing discs during playback

- 1 Press **DISC CHANGE**.
→ The disc tray will open without interrupting current playback.
- 2 To change the inner disc, press **DISC CHANGE** again.
→ "DISC CHANGE" is displayed and the disc will stop playing.
→ The disc tray will close to retrieve the inner disc, then reopen with the inner disc accessible.

Selecting a desired track/passage

To search for a particular passage during playback

- 1 Press ◀◀ or ▶▶ until the desired passage is located.

To select a desired track

- Press ◀ or ▶ repeatedly until the desired track is displayed.
- If playback is stopped, press ▶|| to start playback.

Selecting a desired Album/Title (MP3 disc only)

To select a desired album

- Press **ALBUM** -/+ (◀◀ or ▶▶) repeatedly.
→ **ALB** starts flashing and the album's name will scroll through the display once.

To select a desired title

- Press **TITLE** -/+ repeatedly (◀ / ▶).
→ **TITLE** starts flashing and the title's name will scroll through the display once.

Note:

– The album and title will only be displayed once when selected. To view again, press the respective **DISPLAY** button on the remote control.

Repeat play

You can select and change the various play modes before or during playback.

- 1 Press **REPEAT** on the remote control repeatedly to select :
→ "TRACK" – to repeat playback of the current track.
→ "DISC" – to repeat playback of the current disc.
→ "PROGRAM" – to repeat playback of the programmed tracks.
- 2 To resume normal playback, press **REPEAT** until "REPEAT OFF" is displayed.
→ **REP** is shown, except for REPEAT OFF mode.

Notes:

- During programme play mode, it is not possible to repeat playback the current disc (Repeat Disc mode).
- Pressing the ■ button will cancel all repeat modes.

Random play

- Press **SHUFFLE** on the remote control to turn on/off the shuffle mode.
→ If activated, **SHUFFLE** is shown and the repeat mode (if any) will be cancelled.
→ Random play will start from the current disc tray.
→ If programme mode is active, only the programmed tracks will be played in random order.

Programming the disc tracks

Programming tracks is possible when playback is stopped. Up to 99 tracks can be stored in the memory in any order.

- 1 Load the desired discs on the disc tray (refer to "Loading discs").
- 2 Press **CD 1/2/3** to select a disc.
- 3 Press **STOP** ■ to go to stop mode.
- 4 Press **PROG** to start programming.
→ **PROG** starts flashing.

CD/MP3-CD Operations

- 5 Press ◀ or ▶ repeatedly to select the desired track.
- For MP3 disc, press **ALBUM** $-/+$ and **TITLE** $-/+$ to select the desired album and title for programming.
- 6 Press **PROG** to store the track.
- Repeat **steps 5–6** to store other tracks.
- 7 To end programming, press **■ once**.
→ **PROG** stays and the programme mode remains active.
→ The total number of tracks programmed and the total playing time are displayed.
→ For MP3 disc, total playing time will not be shown.
- 8 To start programme play, press ▶||.
→ "PLAY PROGRAM" is displayed.

Notes:

- It is not possible to create a programme with MP3 tracks from multiple CDs, or combined with normal audio tracks.
- If the total playing time is more than "99:59" then "--:--" is displayed instead of the total playing time.
- If you attempt to programme more than 99 tracks, "FULL" is displayed.
- During programming, if no button is pressed within 20 seconds, the system will exit the programme mode automatically.

To review the programme

- Stop playback and press ◀ or ▶ repeatedly.
- To exit review mode, press **■**.

Erasing the programme

- Press **■ once** when playback is stopped or **twice** during playback.
→ **PROG** disappears and "PROGRAM CLEARED" is displayed.

Note:

- The programme will be erased when the system is disconnected from the power supply or when the disc tray is opened.

For Recording, please refer to "Tape Operation/Recording".

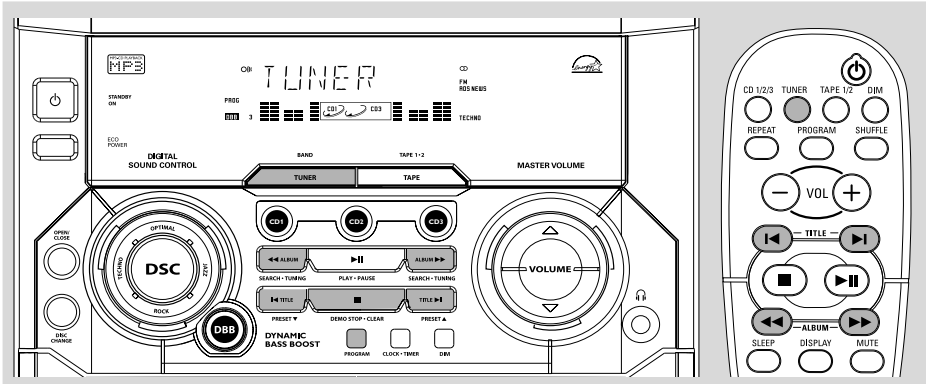

Tuning to radio stations

- 1 Press **TUNER** to select TUNER mode.
→ "TUNER" is displayed. A few seconds later; the current radio frequency will appear on the display.
→ If an FM station is received in stereo, ∞ is displayed.
- 2 Press **TUNER** again to select the desired waveband : FM or MW.
- 3 Press and hold **◀◀** or **▶▶** until the frequency indication starts to change, then release.
→ The display will show "SEARCH" until a radio station with sufficient signal strength is found.
- 4 Repeat step 3 if necessary until you find the desired radio station.
- To tune to a weak station, press **◀◀** or **▶▶** briefly and repeatedly until optimal reception found.

Storing preset radio stations

You can store up to 40 preset radio stations in the memory.

Automatic Preset Programming

- Plug and Play setting (refer to "Basic Functions - Plug and Play").
- OR

- 1 Press **TUNER** to select TUNER mode.

To begin automatic preset from a desired preset number

- Press **◀** or **▶** to select the desired preset number.
→ If a radio station has been stored in one of the presets, it will not be stored again under another preset number.
- 2 Press and hold **PROGRAM** until "AUTO" is displayed.
→ **PROG** starts flashing.
→ All available radio stations with sufficient signal strength will be stored automatically, starting from FM and followed by MW band.
→ When all the available radio stations are stored or the memory for 40 presets are used, the last preset radio station will be played.

Radio Reception

To stop storing the automatic preset

- Press **PROGRAM** or **■** on the system.

Note:

– If no preset number is selected, automatic preset will begin from preset (1) and all your former presets will be overridden.

Manual Preset Programming

- 1 Tune to your desired radio station (refer to "Tuning to radio stations").
- 2 Press **PROGRAM**.
 - **PROG** starts flashing.
 - The next available preset number is displayed for selection.

To store the radio station to another preset number

- Press **◀** or **▶** to select the desired preset number.
- 3 Press **PROGRAM** again to store the radio station.
 - **PROG** disappears.
- Repeat **steps 1–3** to store other radio stations.

To exit manual preset mode

- Press **■** on the system.

Notes:

– If you attempt to store more than 40 preset radio stations, "FULL" is displayed.
– During programming, if no key is pressed within 20 seconds, the system will exit the programme mode automatically.

Tuning to preset radio stations

- Once you've programmed the radio stations, press **◀** or **▶** to select the desired preset number.
 - The preset number, radio frequency, and waveband are displayed.

Erasing a preset radio station

- 1 Press **◀** or **▶** to select the preset radio station to be erased.
- 2 Press and hold **■** on the system until "PRESET DELETED" is displayed.
 - The deleted radio frequency remains on the display.
 - The preset numbers of all other preset radio stations in the band with higher numbers are also decreased by one.
- Repeat **steps 1–2** to erase other preset radio stations.

For Recording, please refer to "Tape Operation/Recording".

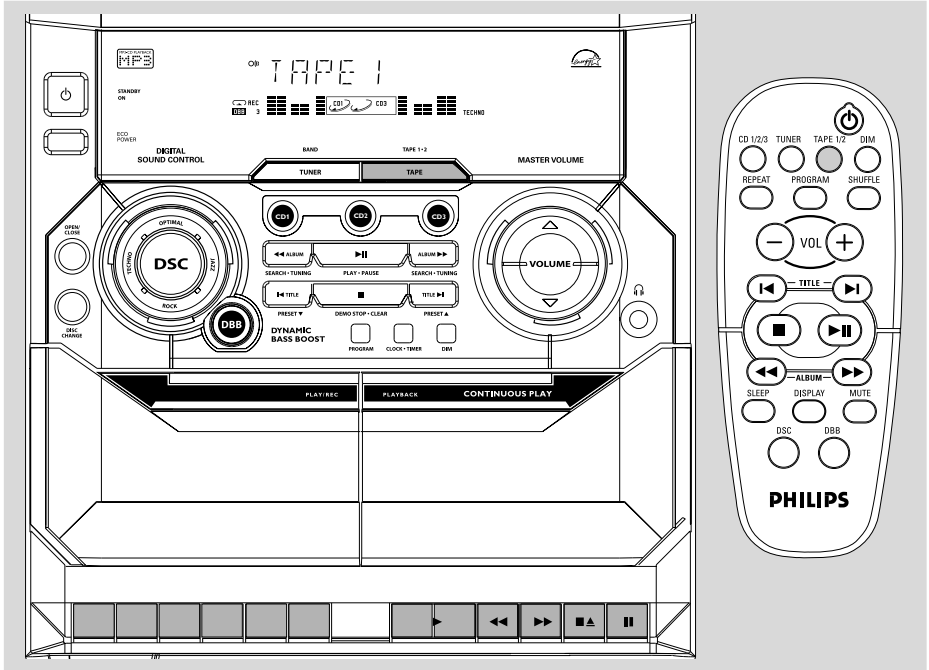

IMPORTANT!

- Before playing a tape, check and tighten slack tape with a pencil. Slack tape may get jammed or may burst in the mechanism.
- C-120 tape is extremely thin and is easily deformed or damaged. It is not recommended for use in this system.
- Store the tapes at room temperature and do not put them too close to a magnetic field (for example, a transformer, TV or speaker).

Loading tape

- 1 Press **TAPE** to select TAPE mode.
→ "TAPE" is displayed.
- 2 Press **▲** to open the tape deck door:
- 3 Load the tape with the open side downward and full spool to the left.
- 4 Close the tape deck door:

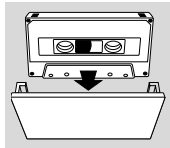

Playing tapes

To playback a selected tape deck

- Press **▶** on tape deck 1 or 2.
→ The tape will stop at the end of playback.

Continuous playback of two tapes

- 1 Load the tapes in tape deck 1 and 2.
- 2 Press **▶** on tape deck 2.
- 3 Press **||** on tape deck 1, followed by **▶**.
→ Playback will begin from tape deck 2 and continue with tape deck 1. It will stop at the end of tape deck 1.

To interrupt playback

- Press **||**.
- To resume playback, press **||** again.

To stop playback

- Press **■▲**.

Tape Operation/Recording

Fast forwarding/rewinding

- 1 Press ◀◀ or ▶▶ until you reach your desired passage.
- 2 Press ■▲ to stop rewinding/fast forwarding.

Notes:

During fast forwarding/rewinding, the keys will not be released at the end of a tape. To switch off the set, make sure the cassette keys are also released.

General information on recording

- For recording, use only tape of IEC type I (normal tape).
- The recording level is set automatically, regardless of the position of the Volume, DBB, DSC and so forth.
- The tape is secured at both ends with leader tape. At the beginning and end of the tape, nothing will be recorded for six to seven seconds.
- To prevent accidental recording, break out the tab on the left shoulder of the tape side you want to protect.

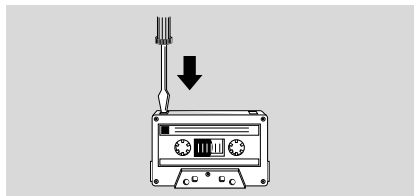

IMPORTANT!

- **Recording is permissible if copyright or other rights of third parties are not infringed upon.**
- **Recording is possible only on tape deck 1.**

Preparation for recording

- 1 Load a recordable tape into tape deck 1 with full spool to the left.
- 2 Prepare the source to be recorded.
CD 1/2/3 – load the disc(s).
TUNER – tune to the desired radio station.
TAPE – load the prerecorded tape into tape deck 2 with the full spool to the left.

When recording is in progress

→ **REC** starts flashing.

- It is not possible to listen to another source.
- It is not possible to activate the timer function during recording or tape dubbing.

One touch recording

- 1 Press **CD 1/2/3** or **TUNER** to select the source.
- 2 Start playback of the selected source.
- 3 Press ● on tape deck 1 to start recording.

To stop recording

- Press ■▲ on tape deck 1.

CD Synchronised start recording

- ① Press **CD 1/2/3** to select the disc.
- You can programme the tracks in the order you want them to be recorded (refer to "CD Operation - Programming the disc tracks").
- ② Press ● on tape deck 1 to start recording.
→ The disc will start playback automatically.

To stop recording

- Press **■▲** on tape deck 1, then press **■** to stop disc playback.

Dubbing tapes

- ① Load the prerecorded tape in tape deck 2.
- Make sure both tapes have their full spool to the left.
- ② Press **||** on tape deck 1 and followed by ●.
- ③ Press **▶** on tape deck 2.
→ Recording will start automatically.
- Dubbing of tapes is possible on one side of the tape only. To continue recording on the reverse side, at the end of side A, flip the tape to side B and repeat the procedure.

To stop dubbing

- Press **■▲** on tape deck 1 and 2.

Notes:

- *Dubbing of tapes is possible only from tape deck 2 to tape deck 1.*
- *To ensure good dubbing, use tapes of the same length.*

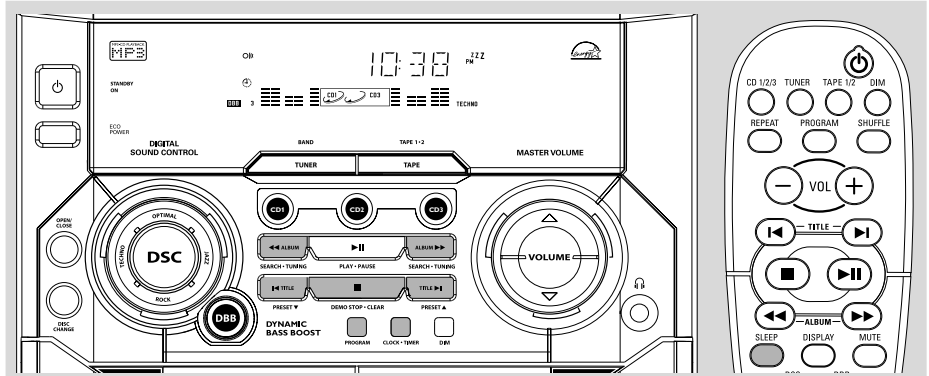

IMPORTANT!

When in Eco Power standby mode, it is not possible to show the clock time or set the clock/timer function.

View clock

The clock (if it is set) will be shown in standby mode.

To view the clock in any source mode (CD or TUNER for example)

- Press **CLOCK•TIMER**.
 - The clock is displayed for a few seconds.
 - If the clock has not been set, "-- : --" is displayed.

Clock setting

The clock can be set in either 12-hour or 24-hour mode ("12:00 AM" or "00:00" for example)

- 1 In standby or view clock mode, press **CLOCK•TIMER once**. In other source mode, press **CLOCK•TIMER twice**.
- 2 Press **PROGRAM** repeatedly to select clock mode.
 - "12:00 AM" or "00:00" starts flashing.
- 3 Press **◀◀** or **▶▶** on the system repeatedly to set the hour.
- 4 Press **◀** or **▶** on the system repeatedly to set the minute.

- 5 Press **CLOCK•TIMER** again to store the setting.
 - The clock starts working.

To exit without storing the setting

- Press **■** on the system.

Notes:



- The clock setting will be cancelled when the power cord is disconnected or if a power failure occurs.
- During clock setting, if no button is pressed within 90 seconds, the system will exit clock setting mode automatically.

Timer setting

The system can switch on to CD or TUNER mode automatically at a preset time, serving as an alarm to wake you up.

IMPORTANT!

- Before setting the timer, ensure that the clock is set correctly.
- The timer will always be switched on after it has been set.
- The timer will not start if a recording is in progress.
- The volume of the timer will increase gradually to the last tuned volume level. If the last tuned volume level is too low, the set will then increase to a predetermined minimum audible level.

- 1 Press and hold **CLOCK•TIMER** for more than **two seconds** to select timer mode.
→ "12:00 AM" or "00:00" or the last timer setting starts flashing.
→  starts flashing.
- 2 Press **CD 1/2/3** or **TUNER** to select the desired source.
→ "[CD 1 | or 2, 3] XX:XX" indicates the CD mode is selected.
→ "TU XX:XX" indicates the Tuner mode is selected.
- Before setting timer, make sure the music source has been prepared.
CD 1/2/3 – Load the disc(s).
TUNER – tune to the desired radio station.
- 3 Press **◀** or **▶** on the system repeatedly to set the hour for the timer to start.
- 4 Press **◀** or **▶** on the system repeatedly to set the minute for the timer to start.
- 5 Press **CLOCK•TIMER** to store the timer:
→ "TIMER ON" is displayed, followed by the set timer "XX:XX" and the selected source.
→  remains on the display.
- At the preset time, the selected source will play.

To exit without storing the setting

- Press **■** on the system.

Notes:

- When the preset time is reached and the selected disc tray is empty, the next available disc will be selected. If all the disc trays are not available, Tuner will be selected automatically.
- During timer setting, if no button is pressed within 90 seconds, the system will exit timer setting mode automatically.

Deactivating the timer

- 1 Press and hold **CLOCK•TIMER** for more than **two seconds**.
- 2 Press **■** on the system to cancel the timer:
→ "CANCEL" is displayed and the  disappears.

Activating the timer (for the same preset time and source)

- 1 Press and hold **CLOCK•TIMER** for more than **two seconds**.
- 2 Press **CLOCK•TIMER** again to store.
→ The last set timer information is displayed for a few seconds and  is shown.

Sleep timer setting

The sleep timer enables the system to switch to standby mode automatically at a preset time.

- 1 Press **SLEEP** on the remote control repeatedly to select a preset time.
→ The selections are as follows (time in minutes):
15 → 30 → 45 → 60 → 90 → 120 →
OFF → 15 ...
→ "SLEEP XX" or "OFF" is displayed. "XX" is the time in minutes.
- 2 When you reach the desired length of time, stop pressing the **SLEEP** button.
→ **ZZZ** is shown, except for "OFF" mode.
→ The sleep timer is now set. Before the system switches to standby mode, a countdown of 10 seconds is displayed.
"SLEEP 10" → "SLEEP 9".... → "SLEEP 1"
→ "SLEEP"

To check the remaining length of time after sleep timer is activated

- Press **SLEEP** once.

To change the preset sleep timer

- Press **SLEEP** again while the remaining sleep timer is shown.
→ The display will show the next sleep timer options.

To deactivate the sleep timer

- Press **SLEEP** repeatedly until "OFF" is displayed, or press the **STANDBY ON** button.

Specifications

AMPLIFIER

Output power 2 x 20 W MPO
..... 2 x 10 W RMS⁽¹⁾
Signal-to-noise ratio ≥ 67 dBA (IEC)
Frequency response 50 – 15000 Hz
Impedance loudspeakers 4 Ω
Impedance headphones 32 Ω – 1000 Ω
(1)(4 Ω , 1 kHz, 10% THD)

CD PLAYER

Number of programmable tracks 99
Frequency response 20 – 20000 Hz
Signal-to-noise ratio ≥ 75 dBA
Channel separation ≥ 60 dB (1 kHz)
Total harmonic distortion $< 0.003\%$

RADIO RECEPTION

FM wave range 87.5 – 108 MHz
MW wave range 531 – 1602 kHz
Number of presets 40
Antenna
FM 75 Ω wire
MW Loop antenna

TAPE PLAYER

Frequency response
Normal tape (type I) 80 – 12500 Hz (8 dB)
Signal-to-noise ratio
Normal tape (type I) ≥ 48 dBA
Wow and flutter $\leq 0.4\%$ DIN

SPEAKERS

System double port bass reflex
Impedance 4 Ω
Dimensions (w x h x d) .. 200 x 310 x 235 (mm)
Weight 1.8 kg each

GENERAL

Material/finish Polystyrene
AC Power 220 – 230 V / 50 Hz
Power Consumption
Active 40 W
Standby ≤ 16 W
Eco Power Standby < 0.5 W
Dimensions (w x h x d) .. 265 x 310 x 330 (mm)
Weight (without speakers) 4.6 kg

Specifications and external appearance are subject to change without notice.

Cleaning the Cabinet

- Use a soft cloth slightly moistened with a mild detergent solution. Do not use a solution containing alcohol, spirits, ammonia or abrasives.

Cleaning Discs

- When a disc becomes dirty, clean it with a cleaning cloth. Wipe the disc from the centre out. Do not wipe in circular motion.
- Do not use solvents such as benzene, thinner, commercially available cleaners, or antistatic spray intended for analogue records.

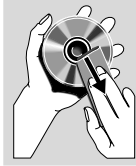

Cleaning the disc lens

- After prolonged use, dirt or dust may accumulate at the disc lens. To ensure good playback quality, clean the disc lens with Philips CD Lens Cleaner or any commercially available cleaner. Follow the instructions supplied with cleaner.

Cleaning the Heads and the Tape Paths

- To ensure good recording and playback quality, clean the heads (A) and (B), the capstan(s) (C), and pressure roller(s) (D) after every 50 hours of tape operation.
- Use a cotton swab slightly moistened with cleaning fluid or alcohol.
- You also can clean the heads by playing a cleaning tape once.

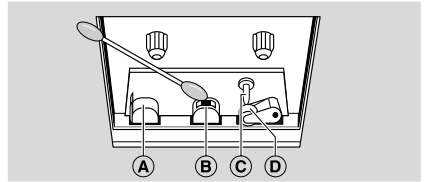

Demagnetising the heads

- Use a demagnetising tape available at your dealer.

Troubleshooting

WARNING

Under no circumstances should you try to repair the system yourself, as this will invalidate the warranty. Do not open the system as there is a risk of electric shock.

If a fault occurs, first check the points listed below before taking the system for repair. If you are unable to remedy a problem by following these hints, consult your dealer or Philips for help.

Problem	Solution
"NO DISC" is displayed.	<ul style="list-style-type: none"> ✓ Insert a disc. ✓ Check if the disc is inserted upside down. ✓ Wait until the moisture condensation at the lens has cleared. ✓ Replace or clean the disc, see "Maintenance".
"DISC NOT FINALIZED" is displayed.	<ul style="list-style-type: none"> ✓ Use a finalised CD-RW or CD-R.

Problem	Solution
Radio reception is poor.	<ul style="list-style-type: none"> ✓ If the signal is too weak, adjust the antenna or connect an external antenna for better reception. ✓ Increase the distance between the Mini HiFi System and your TV or VCR.
Recording or playback cannot be made.	<ul style="list-style-type: none"> ✓ Clean deck parts, see "Maintenance". ✓ Use only NORMAL (IEC I) tape. ✓ Apply a piece of adhesive tape over the missing tab space.
The system does not react when buttons are pressed.	<ul style="list-style-type: none"> ✓ Remove and reconnect the AC power plug and switch on the system again.
Sound cannot be heard or is of poor quality.	<ul style="list-style-type: none"> ✓ Adjust the volume. ✓ Disconnect the headphones. ✓ Check that the speakers are connected correctly. ✓ Check if the stripped speaker wire is clamped.
The left and right sound outputs are reversed.	<ul style="list-style-type: none"> ✓ Check the speaker connections and location.
The remote control does not function properly.	<ul style="list-style-type: none"> ✓ Select the source (CD 1/2/3 or TUNER, for example) before pressing the function button (▶, ◀, ▶).) ✓ Reduce the distance between the remote control and the system. ✓ Insert the batteries with their polarities (+ / - signs) aligned as indicated. ✓ Replace the batteries. ✓ Point the remote control directly towards the IR sensor.
The timer is not working.	<ul style="list-style-type: none"> ✓ Set the clock correctly. ✓ Press and hold CLOCK•TIMER to switch on the timer. ✓ If recording or tape dubbing is in progress, stop recording.
Not all lighted buttons are showing light.	<ul style="list-style-type: none"> ✓ Press DIM to select DIM OFF display mode.
The Clock/Timer setting is erased.	<ul style="list-style-type: none"> ✓ Power has been interrupted or the power cord has been disconnected. Reset the clock/timer.
The system displays features automatically.	<ul style="list-style-type: none"> ✓ Press and hold ■ on the system to switch off the demonstration.