

Register your product and get support at
www.philips.com/welcome

User manual

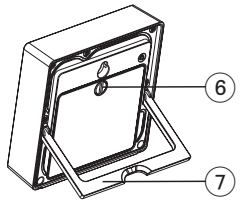

1

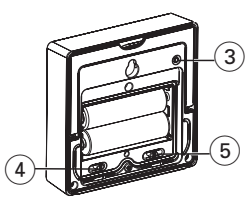
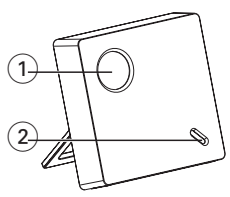
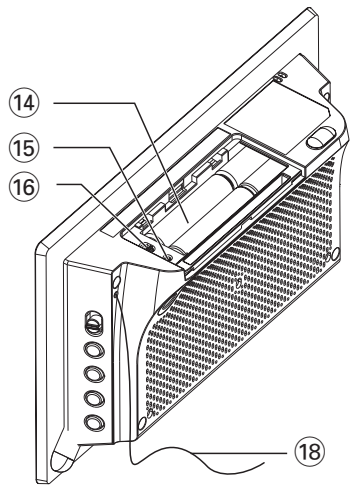
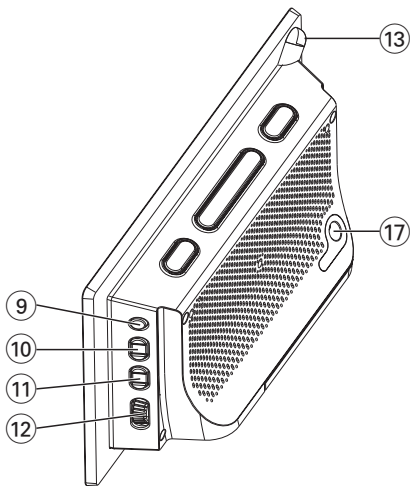
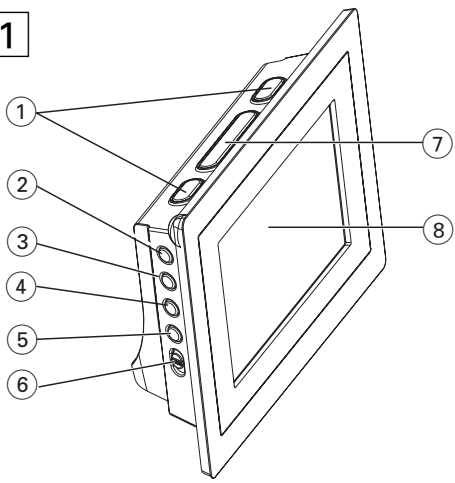

2

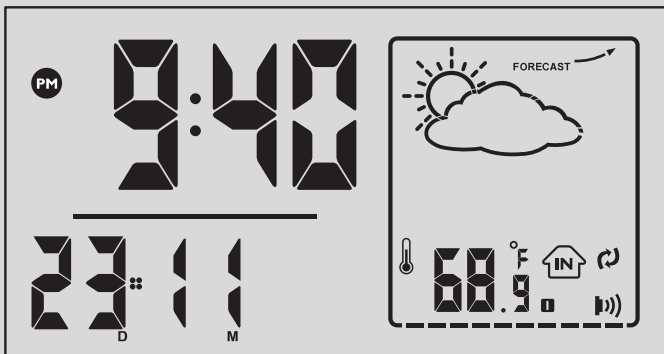

3

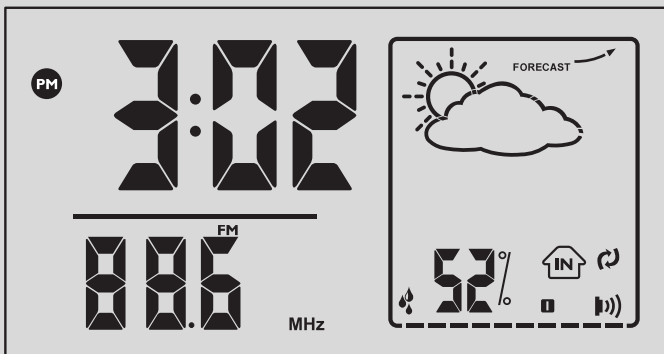

4

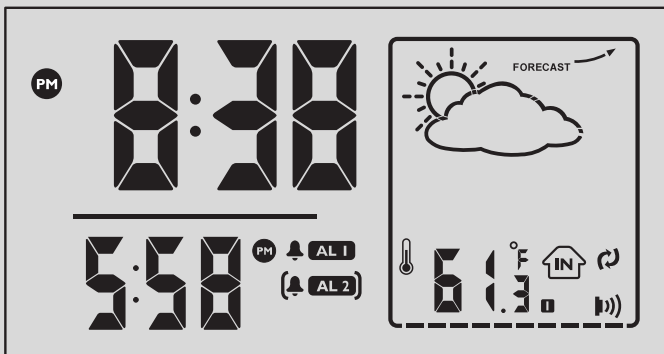

Congratulations on your purchase and welcome to Philips!

To fully benefit from the support that Philips offers, register your product at www.philips.com/welcome.

IMPORTANT!

PLEASE NOTE THAT THE VOLTAGE SELECTOR LOCATED AT THE REAR OF THIS SYSTEM IS PRESET AT 220V FROM THE FACTORY. FOR COUNTRIES THAT OPERATE AT 110V-127V PLEASE ADJUST TO 110V-127V BEFORE YOU SWITCH ON THE SYSTEM.

Supplied accessories

- 1 X certified AC 7.5V adapter
(Input: 220-230V ~50Hz 30mA,
Output: 7.5V===250mA)
- 1 X outdoor sensor

Controls (see 1)

- ① **ALM 1/ ALM 2**
 - activates/confirms ALARM 1 /ALARM 2 time setting
 - switches off the alarm
- ② **RADIO ON/OFF**
 - switches the radio on/off
 - switches the set on or to standby
 - stops the active buzzer or radio alarm for 24 hours
 - switches off the sleep timer
- ③ **TIME SET**
 - activates/confirms clock/date setting
- ④ **AUTO SCAN/DATE**
 - programs preset radio stations
 - displays month and day information in standby mode
 - changes display order between month and day during setting time
 - receives transmission from the sensor
- ⑤ **DISPLAY**
 - toggles between indoor temperature, indoor humidity and outdoor temperature
- ⑥ **RADIO•BUZ**
 - selects alarm mode: radio or buzzer
- ⑦ **REPEAT ALARM/BRIGHTNESS CONTROL**
 - pushes to switch off alarm for a 9-minute period

- changes the brightness of the display illumination
- ⑧ **LCD Display** – shows the clock/ alarm time or radio and weather forecast information
- ⑨ **SLEEP/ALARM RESET**
 - switches off radio for timer mode
 - adjusts timer options for radio playback
 - stops the active buzzer or radio alarm for 24 hours
- ⑩ **PRESET +/-**
 - selects a preset radion station
- ⑪ **TUNING +/-**
 - tunes to radio stations
 - adjusts clock / alarm time
- ⑫ **VOL**– adjusts sound level
- ⑬ **Color lamp**– indicates the different forthcoming weather situation
- ⑭ **Battery compartment** – opens to insert 4 x 1.5V AAA batteries
- ⑮ **RESET**
 - press if the set / display does not react to operation of any button
- ⑯ **(°C °F) Slide Switch**
 - selects between Centigrade (°C) or Fahrenheit (°F) temperature unit display
- ⑰ **DC 7.5V** 
 - socket for AC/DC 7.5V adapter
- ⑱ **Pigtail** – FM antenna to improve FM reception

Controls on the sensor (see 1)

- ① **LCD display**
 - shows current temperature, and low battery indication of the sensor
- ② **LED light**
 - flashes when the sensor is transmitting
- ③ **RESET**
 - resets to start transmitting
- ④ **(°C °F) Slide Switch**
 - selects between Centigrade (°C) or Fahrenheit (°F) temperature unit display
- ⑤ **CHANNEL 1/ 2 /3**
 - selects RF channel to transmit and receive between the sensor and the main unit
- ⑥ **Door lock**
 - turns to lock and un-lock the sensor door.
- ⑦ **Sensor support**
 - pulls out to stand the sensor

Power supply

IMPORTANT!

- **THE SYSTEM IS EQUIPPED WITH A VOLTAGE SELECTOR, SET THE VOLTAGE SELECTOR TO MATCH THE LOCAL POWER LINE.**

Make sure you remove the plug from the set and wall outlet before inserting batteries.

Batteries (not supplied) for the main unit and the outdoor sensor

- 1 Open the battery door and insert 4 batteries, typed **AAA** for the main unit, and 2 batteries typed **AA** for the sensor; with the correct polarity as indicated by the "+" and "-" symbols inside the compartment.
- 2 Replace the battery door, making sure the batteries are firmly and correctly in place. The set is now ready to operate.

Batteries contain chemical substances, so they should be disposed of properly.

Mains Adapter.

Note: Remove the batteries before you use the AC adapter.

- 1 Connect the mains adapter to the set's DC 7.5V socket and to the power socket.

Helpful hints:

To avoid damage to the set, use only the adapter supplied!

The type plate is located on the bottom of the set.

Setting the clock and date (see 2)

The clock uses 24-hour time format.

Manual setting

You may also set or adjust time manually.

- 1 Press and hold **TIME SET** for 2 seconds.
→ The digits for year flash.
- 2 Hold down or press **TUNING +/-** repeatedly to adjust the time digits.
- When it comes to adjust month and day, you may press **AUTO SCAN/DATE** to change the display order between month and day.
- 3 Press **TIME SET** to confirm the setting.
→ The digits for month flashes.
- 4 Repeat **steps 2-3** to complete all the other settings for month, day, hour and minute.

Standby power consumption

(clock mode).....**1.5W**

Digital tuner

Tuning to radio station

- 1 Press **RADIO ON/OFF** to switch on the radio (FM only).
 - The radio station frequency and the wave-band will be displayed. (See **3**).
 - 2 Press and hold **TUNING +/-** until the frequency in the display starts running.
 - The radio automatically tunes to a station of sufficient reception.
 - 3 Repeat step 2 if necessary until you find the desired station.
- To tune to a weak station, press **TUNING +/-** briefly and repeatedly until you have found optimal reception.

To improve reception:

FM: Extend and adjust the pigtail for optimum reception.

Programming radio stations

You can store up to a total of 10 radio stations in the memory (10 FM) manually or automatically (Auto store). Any previous presets will be erased.

Manual programming

- 1 Tune to your desired station (see **Tuning to radio stations**).
- 2 Press and hold **PRESET +/-** to activate programming.
 - Display: **PRESET** flashes.
- 3 Press **PRESET +/-** once or more to allocate a number from 1 to 10.
- 4 Repeat steps 1-3 to store other stations.

Helpful hints:

- You can erase a preset station by storing another frequency in its place.

Autostore

Autostore automatically starts programming radio stations from preset 1. Any previous presets e.g. manually programmed will be erased.

- 1 In radio mode, press **AUTO SCAN/DATE** until the frequency in the display starts running.

→ Available stations are programmed (FM). After all stations are stored, the first auto-store preset station will then automatically play.

To listen to a preset or autostored station

Press the **PRESET +/-** buttons once or more until the desired preset station is displayed.

Using the alarm

AJ260 allows you to simultaneously set two different alarms (ALARM 1 and ALARM 2) which can go off in the radio or buzzer mode. The clock time needs to be set correctly before using alarm.

Setting alarm time

- 1 Press briefly **ALM 1** or **ALM 2** to display AL1 or AL2 icon.
- 2 Press and hold **ALM 1/ ALM 2** for two seconds.
 - The hour digits flash.
- 3 Hold down or press **TUNING +/-** repeatedly to adjust the hours.
- 4 Press **ALM 1/ALM 2** to confirm the setting.
 - AL1/AL2 icon and the minute digits flash.
- 5 Hold down or press **TUNING +/-** repeatedly to adjust the minutes.
- 6 Press **ALM 1/ALM 2** to confirm the setting.

Helpful hints:

- In standby mode, press **DATE** to display month and day information. In radio mode, to display alarm time, press **ALM 1/ALM 2**.

Selecting alarm mode (activating)

- 1 Press **RADIO ON/OFF** to switch to standby.
- 2 Select your choice of alarm mode: either radio, or buzzer by using the **RADIO•BUZ** slider.
- 3 Press **ALM 1/ALM 2** once or more to display .

→ When alarm is activated,  is displayed. (See **4**).

- At the set alarm time, radio or buzzer will switch on automatically.

Switching off the alarm

There are three ways of switching off the alarm. Unless you choose to cancel the alarm completely, the DAILY ALARM RESET option will be automatically kept activated from the time your alarm first goes off.

Daily alarm reset

If you want the alarm to be stopped immediately but also wish to repeat the alarm call at the same time for the following day:

- 1 During the alarm call, press once **SLEEP/ALARM RESET** or **RADIO ON/OFF**.

Repeat alarm

This will repeat your alarm call at 9-minute intervals.

- 1 During the alarm call, press **REPEAT ALARM/BRIGHTNESS CONTROL**.

Switching off the alarm completely

Press once or more corresponding **ALM 1** or **ALM 2** until  disappears.

Sleep

The clock radio has a built-in sleep timer, which enables the set to be automatically switched off during radio playback after a set period of time.

Setting the sleep time



- 1 During radio playback, set your timer by pressing repeatedly **SLEEP** until the desired timer option appears.
→ Selections are follows (time in minute)
10 → 20 → 30 → 60 → 90 → 120 → OFF → 10
- 2 The set will turn off automatically at the selected time.
- 3 **To cancel the timer function**, either press **SLEEP** once or more until "OFF" appears, or press **RADIO ON/OFF** to switch to standby.
→ "SLEEP" disappears when sleep function is cancelled.

Note:

– The sleep function does not affect your alarm time setting(s).

Weather forecast







The unit is capable of detecting atmospheric pressure changes. Based on the collected data, it can predict the weather in the next 12 to 24 hours. The effective range covers an area of approximately 30 to 50 km.

FORECAST 	Weather may get better.
FORECAST 	Weather is in steady state.
FORECAST 	Weather may get bad.

- Each weather forecast status will be displayed with graphical animation and different lighting colors at the top left hand corner of the unit, see the figure below.

About color lighting

- Battery operation: The light turns on for 10 seconds after each atmospheric measurement, or after any button pressed.
- AC operation: The light always turns on when the power is switched on. To let the light turn on just like the case of battery operation mentioned above, press and hold **REPEAT ALARM/BRIGHTNESS CONTROL** for about 10 seconds.

LCD display	Light color 
 Sunny	Amber
 Partly cloudy	Light blue
 Cloudy	Blue
 Rainy	Purple
 Stormy	Red
 Snow	White

Notes:

- The weather forecast based on the atmospheric pressure may vary slightly from the actual weather situation.
- The weather forecasts from this unit are predictions that covers the next 12 to 24 hours. It may not necessarily reflect the current situation.

Using the sensor to detect outdoor temperature

The main unit comes with a outdoor sensor. Using the sensor, the unit is capable to measure and display outdoor temperature through receiving data transmitted from the sensor placed at other location.

Wirelessly Connecting the sensor to the main unit

- 1 Place the sensor in a desired open area. The place must be within 50 meters away from the main unit. Make sure the sensor is loaded with the batteries.
- **For the first time** using the outdoor sensor and the main unit, press **RESET** located on the sensor back, and **RESET** located in the battery compartment of the main unit. Then, the main unit will begin to receive transmission from the sensor.
 - To update the outdoor temperature from the sensor any time, press and hold **AUTO SCAN/DATE** for 5 seconds.
 - The temperature will be updated from the sensor about every 3 minutes.
- When the outdoor temperature is updating with the sensor searching,  is displayed on the main unit. (See [4])

To Improve the sensor reception

In case of intermittent/no connection,

- slide the **CHANNEL** switch to Channel **2** or **3**, located in the battery compartment of the sensor; then repeat the setup connection described above.
- reduce the distance between the sensor and the main unit.

- press and hold **AUTO SCAN /DATE** for about 3 seconds to force the main unit to search for the remote sensor signal.

Note:

- The effective range of the sensor is 50 meters away from the main unit. The range may vary from the actual geographical situation.

Indoor temperature and humidity

- The unit can also auto measure and display current temperature. in Centigrade (°C) or Fahrenheit (°F).
- Press **DISPLAY** to toggle the display between indoor temperature, indoor humidity and outdoor temperature (See [2], [3], [4]).
- Press and hold **DISPLAY** to enter auto-scroll mode. Screen mode will show for 5 seconds.
- To select between °C or °F reading, use the **(°C °F)** slide switch (located in the battery compartment).

Illumination brightness

Press **REPEAT ALARM / BRIGHTNESS CONTROL** once or more.

- The brightness of the display can be adjusted: **Bright** → **Low** → **Off** → **Bright**

Low battery indication

When the batteries of the main unit or the sensor are running low, the low battery icon will be displayed on the main unit, or the sensor, indicating that the batteries should be replaced soon.

Safety and maintenance

Safety and general maintenance

- If you do not intend to use the clock radio for a long time, withdraw the power cord from the wall outlet.
- Place the set on a hard and flat surface so that the system does not tilt.
- Install the unit near the AC outlet and where the AC power plug can be easily reached.
- The apparatus shall not be exposed to dripping or splashing.
- The apparatus shall not be exposed to dripping or splashing.
- Do not expose the set, batteries, to humidity, rain, sand or excessive heat caused by heating equipment or direct sunlight.
- No objects filled with liquids, such as vases, shall be placed on the apparatus.
- No naked flame sources, such as lighted candles, should be placed on the apparatus.
- Do not cover the set. Adequate ventilation with a minimum gap of 6 inches between the ventilation holes and surrounding surfaces is necessary to prevent heat build-up.
- The mechanical parts of the set contain self-lubricating bearings and must not be oiled or lubricated.
- To clean the set, use a soft dry cloth. Do not use any cleaning agents containing alcohol, ammonia, benzene or abrasives as these may harm the housing.

Environmental information

All unnecessary packaging material has been omitted. The packaging can be easily separated into three materials: cardboard, polystyrene and plastic.

Your set consists of materials which can be recycled if disassembled by a specialized company. Please observe the local regulations regarding the disposal of packaging, dead batteries and old equipment.

Troubleshooting

If a fault occurs, first check the points listed below before taking the set for repair. If you are unable to remedy a problem by following these hints, consult your dealer or service center.

WARNING: Do not open the set as there is a risk of electric shock. Under no circumstances should you try to repair the set yourself, as this will invalidate the warranty.

No sound.

- Volume not adjusted.
- Adjust the VOLUME.

Display error / no reaction to any controls.

- Electrical malfunction
- Press RESET hole on the bottom of the set with a ball pen.

Occasional crackling sound during FM broadcast.

- Weak signal.
- Extend the pigtail antenna fully.

The alarm does not function.

- Alarm time not set.
- See section on **Setting alarm time**.
- Alarm mode not selected.
- See section on **Setting alarm mode**.
- Volume too low for radio.
- Increase the volume.

The main unit cannot read or update outdoor temperature from the sensor

- No signal or weak signal.
- Reset both the main unit and the sensor. Or improve the sensor reception. See "**Using the sensor to detect outdoor temperature**".

CAUTION

High voltage! Do not open. You run the risk of getting an electric shock. The machine does not contain any user-serviceable parts.

Modification of the product could result in hazardous radiation of EMC or other unsafe operation.

Meet Philips at the Internet
<http://www.philips.com>

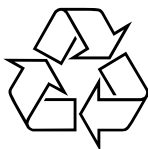

AJ260