

Register your product and get support at
www.philips.com/welcome

HTS3510
HTS3520



PHILIPS

Contents

1 Notice	4
Copyright	4
About Progressive Scan	4
Trademarks	4

2 Important	5
Safety	5
Product care	5
Disposal of your old product and batteries	6

3 Your home theater	6
Main unit	6
Remote control	7

4 Connect your home theater	8
Connectors	8
Connect to the TV	8
Connect audio from TV or other devices	9
Connect a microphone	9

5 Use your home theater	10
Before you start	10
Choose your sound	10
Play a disc	10
Play from a USB storage device	11
More play features for disc or USB	12
Play from radio	12
Play audio from TV or other devices	13
Create MP3 audio files	13

6 Change settings	14
Access the setup menu	14
Change general settings	14
Change audio settings	14
Change video settings	15
Change preference settings	15

7 Update software	16
Check software version	16
Update software from a CD-R or USB	16

8 Product specifications	16
---------------------------------	----

9 Troubleshooting	18
--------------------------	----

10 Index	19
-----------------	----

1 Notice

Copyright



This item incorporates copy protection technology that is protected by U.S. patents and other intellectual property rights of Rovi Corporation. Reverse engineering and disassembly are prohibited.

About Progressive Scan

Consumers should note that not all high definition television sets are fully compatible with this product and may cause artifacts to be displayed in the picture. In case of 525 or 625 progressive scan picture problems, it is recommended that the user switch the connection to the 'standard definition' output. If there are questions regarding our TV set compatibility with this model 525p and 625p DVD player, please contact our customer service center.

Trademarks



Manufactured under license from Dolby Laboratories. Dolby, Pro Logic, and the double-D symbol are trademarks of Dolby Laboratories.



DivX®, DivX Certified®, and associated logos are registered trademarks of DivX, Inc. and are used under license.

ABOUT DIVX VIDEO: DivX® is a digital video format created by DivX, Inc. This is an official DivX Certified device that plays DivX video. Visit www.divx.com for more information and software tools to convert your files into DivX video.

ABOUT DIVX VIDEO-ON-DEMAND: This DivX Certified® device must be registered in order to play DivX Video-on-Demand (VOD) content. To generate the registration code, locate the DivX VOD section in your device setup menu. Go to vod.divx.com with this code to complete the registration process and learn more about DivX VOD.



Windows Media and the Windows logo are trademarks, or registered trademarks of Microsoft Corporation in the United States and/or other countries.



HDMI, and HDMI logo, and High-Definition Multimedia Interface are trademarks or registered trademarks of HDMI licensing LLC in the United States and other countries.



The USB-IF Logos are trademarks of Universal Serial Bus Implementers Forum, inc.



2 Important

Read and understand all instructions before you use your home theater. If damage is caused by failure to follow instructions, the warranty does not apply.

Safety

Risk of electric shock or fire!

- Never expose the product and accessories to rain or water. Never place liquid containers, such as vases, near the product. If liquids are spilt on or into the product, disconnect it from the power outlet immediately. Contact Philips Consumer Care to have the product checked before use.
- Never place the product and accessories near naked flames or other heat sources, including direct sunlight.
- Never insert objects into the ventilation slots or other openings on the product.
- Where the mains plug or an appliance coupler is used as the disconnect device, the disconnect device shall remain readily operable.
- Disconnect the product from the power outlet before lightning storms.
- When you disconnect the power cord, always pull the plug, never the cable.

Risk of short circuit or fire!

- Before you connect the product to the power outlet, ensure that the power voltage matches the value printed on the back or bottom of the product. Never connect the product to the power outlet if the voltage is different.

Risk of injury or damage to the home theater!

- For wall-mountable products, use only the supplied wall mount bracket. Secure the wall mount to a wall that can support the combined weight of the product and the wall mount. Koninklijke Philips Electronics N.V. bears no responsibility for improper wall mounting that results in accident, injury or damage.
- For speakers with stands, use only the supplied stands. Secure the stands to the speakers tightly. Place the assembled stands on flat, level surfaces that can support the combined weight of the speaker and stand.

- Never place the product or any objects on power cords or on other electrical equipment.
- If the product is transported in temperatures below 5°C, unpack the product and wait until its temperature matches room temperature before connecting it to the power outlet.
- Visible and invisible laser radiation when open. Avoid exposure to beam.
- Do not touch the disc optical lens inside the disc compartment.

Risk of overheating!

- Never install this product in a confined space. Always leave a space of at least four inches around the product for ventilation. Ensure curtains or other objects never cover the ventilation slots on the product.

Risk of contamination!

- Do not mix batteries (old and new or carbon and alkaline, etc.).
- Remove batteries if they are exhausted or if the remote control is not to be used for a long time.
- Batteries contain chemical substances, they should be disposed of properly.

Product care

- Do not insert any objects other than discs into the disc compartment.
- Do not insert warped or cracked discs into the disc compartment.
- Remove discs from the disc compartment if you are not using the product for an extended period of time.
- Only use microfiber cloth to clean the product.

Disposal of your old product and batteries



Your product is designed and manufactured with high quality materials and components, which can be recycled and reused.



When this crossed-out wheeled bin symbol is attached to a product it means that the product is covered by the European Directive 2002/96/EC. Please inform yourself about the local separate collection system for electrical and electronic products.

Please act according to your local rules and do not dispose of your old products with your normal household waste.

Correct disposal of your old product helps to prevent potential negative consequences for the environment and human health.



Your product contains batteries covered by the European Directive 2006/66/EC, which cannot be disposed with normal household waste.

Please inform yourself about the local rules on separate collection of batteries because correct disposal helps to prevent negative consequences for the environmental and human health.

3 Your home theater

Congratulations on your purchase, and welcome to Philips! To fully benefit from the support that Philips offers, register your home theater at www.philips.com/welcome.

Main unit

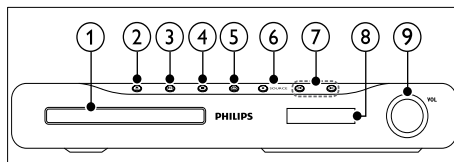

- ① **Disc compartment**
- ② **▲ (Open/Close)**
Opens or closes the disc compartment.
- ③ **▶|| (Play/Pause)**
Starts, pauses or resumes play.
- ④ **■ (Stop)**
 - Stops play.
 - In radio mode, erases the current preset radio station.
- ⑤ **⏻ (Standby-On)**
Switches the home theater on or to standby.
- ⑥ **SOURCE**
Selects an audio/video source for the home theater.
- ⑦ **◀ / ▶**
 - Skips to the previous or next track, chapter or file.
 - In radio mode, selects a preset radio station.
- ⑧ **Display panel**
- ⑨ **Volume control wheel**

Remote control

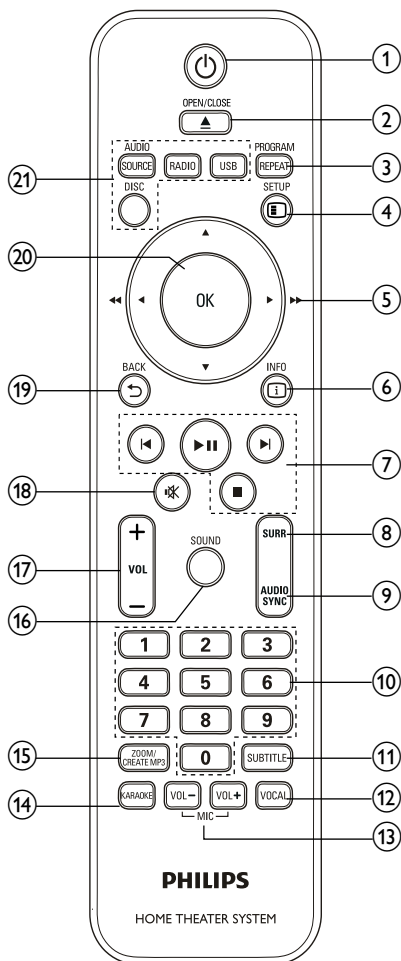

- ① **⏻ (Standby-On)**
Switches the home theater on or to standby.
- ② **▲ OPEN/CLOSE**
Opens or closes the disc compartment.
- ③ **REPEAT / PROGRAM**
 - Selects or turns off repeat mode.
 - In radio mode, program radio stations.
- ④ **⌂ SETUP**
Accesses or exits the setup menu.
- ⑤ **▲▼◀▶ (Navigation buttons)**
 - Navigate menus.
 - In video mode, press left or right to fast backward or fast forward.
 - In radio mode, press left or right to search a radio station; press up or down to fine tune a radio frequency.
- ⑥ **ℹ INFO**
Displays information about what is playing.
- ⑦ **Playback buttons**
Control playback.
- ⑧ **SURR (Surround Sound)**
Switches to surround sound or stereo sound.
- ⑨ **AUDIO SYNC**
 - Selects an audio language or channel.
 - Press and hold to synchronize audio with video. Use with +/-.
- ⑩ **Numeric buttons**
Selects an item to play.
- ⑪ **SUBTITLE**
Selects subtitle language for video.
- ⑫ **VOCAL**
Turns off or on the vocal by changing the audio channel.
- ⑬ **MIC VOL +/-**
Increases or decreases microphone volume.
- ⑭ **KARAOKE**
Toggles through various karaoke options.
- ⑮ **CREATE MP3 / ZOOM**
 - Accesses the menu to create MP3.
 - Zooms into a video scene or picture.
- ⑯ **SOUND**
Selects a sound mode.
- ⑰ **VOL +/-**
Increases or decreases volume.
- ⑱ **🔇 (Mute)**
Mutes or restores volume.
- ⑲ **↶ BACK**
Returns to a previous menu screen.
- ⑳ **OK**
Confirms an entry or selection.
- ㉑ **Source buttons**
 - **AUDIO SOURCE**: Selects an audio input source.
 - **RADIO**: Switches to FM radio.
 - **USB**: Switches to USB storage device.
 - **DISC**: Switches to disc source.

4 Connect your home theater

theater

This section helps you connect your home theater to a TV and other devices. The basic connections of the home theater with its accessories are provided in the Quick Start. For a comprehensive interactive guide, see www.connectivityguide.philips.com.

Note

- Refer to the type plate at the back or bottom of the product for identification and supply ratings.
- Before you make or change any connections, ensure that all devices are disconnected from the power outlet.

Connectors

Connect other devices to your home theater.

Side connectors

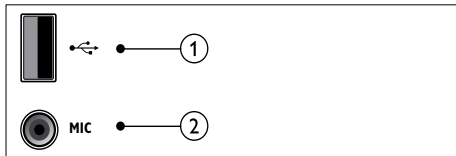

- ① **(USB)**
Audio, video or picture input from a USB storage device.
- ② **MIC**
Audio input from a microphone.

Back connectors



- ① **AC MAINS~**
Connects to the power supply.
- ② **SPEAKERS**
Connects to the supplied speakers and subwoofer.
- ③ **HDMI OUT**
Connects to the HDMI input on the TV.
- ④ **VIDEO OUT-VIDEO**
Connects to the composite video input on the TV.
- ⑤ **AUDIO IN-AUX**
Connects to the analog audio output on the TV or an analog device.
- ⑥ **FM ANTENNA**
Connects the FM antenna for radio reception.
- ⑦ **COMPONENT VIDEO OUT-Y Pb Pr**
Connects to the component video input on the TV.

Connect to the TV

Connect your home theater directly to a TV through one of the following connectors (from highest to basic quality video):

- ① **HDMI**
- ② **Component video**
- ③ **Composite video**

Option 1: Connect to the TV through HDMI

Note

- If the HDTV has a DVI connector, connect using an HDMI/DVI adapter.

(Cable not supplied)

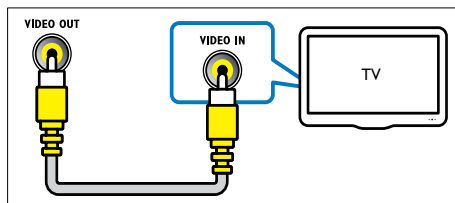
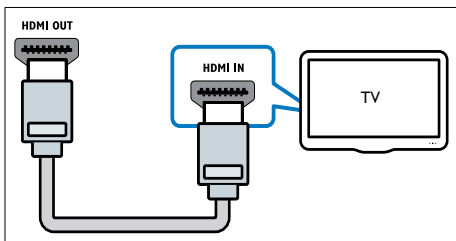

Connect audio from TV or other devices

Use your home theater to play audio from the TV or other device such as a cable box.

Option 2: Connect to the TV through YPbPr (component video)

Note

- The component video cable or connector might be labeled **Y Cb Cr** or **YUV**.

Tip

- Press **AUDIO SOURCE** to select the audio output of your connection.

(Cable not supplied)

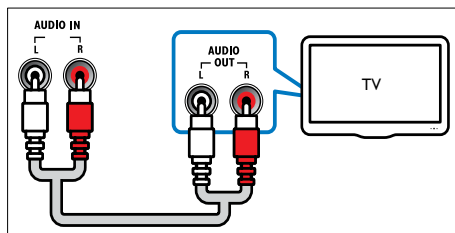
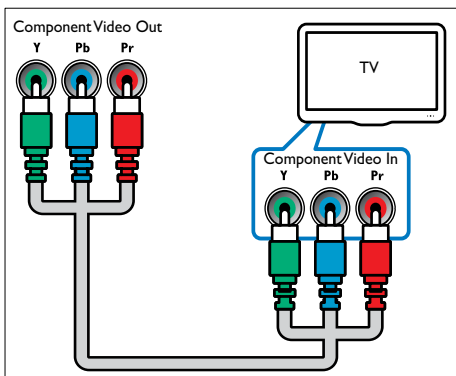

Connect a microphone

(Microphone not supplied)

Option 3: Connect to the TV through composite video (CVBS)

Note

- The composite video cable or connector might be labeled **AV IN**, **VIDEO IN**, **COMPOSITE** or **BASEBAND**.

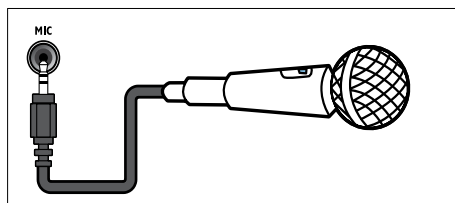

5 Use your home theater

This section helps you use the home theater to play media from a wide range of sources.

Before you start

Check that you:

- Make the necessary connections and complete the setup as described in the Quick Start.
- Switch the TV to the correct source for the home theater.

Choose your sound

This section helps you choose the ideal sound for your video or music.

Change sound mode

Select predefined sound modes to suit your video or music.



Press **SOUND** repeatedly to cycle through the available sound modes.

Sound mode	Description
ACTION / ROCK	Enhanced low and high-range. Ideal for action movies and rock or pop music.
DRAMA / JAZZ	Clear mid and high-range. Ideal for drama movies and jazz music.
CONCERT/ CLASSIC	Neutral sound. Ideal for live concerts and classical music.
SPORTS	Moderate mid-range and surround effects for clear vocals and the atmosphere of a live sport venue.
NIGHT	Dynamically controlled sound mode suitable for watching movies at night or for non-intrusive background music.

Change surround sound mode

Experience an immersive audio experience with surround sound modes.

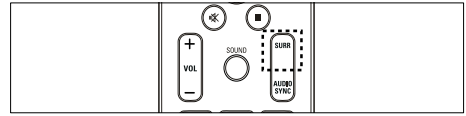

Press **SURR** repeatedly to cycle through the available surround modes.

Option	Description
MULTI-CHANNEL	Immersive multi-channel sound for an enhanced movie experience.
STEREO	Two-channel stereo sound. Ideal for listening to music.

Play a disc

The home theater can play a wide variety of discs, including video, audio and mixed media (for example, a CD-R that contains JPEG pictures and MP3 music).

- 1 Insert a disc into the home theater.
- 2 Press **DISC**.
↳ The disc plays or the disc main menu appears.
- 3 Press the following buttons to control play:

Button	Action
Navigation buttons	Navigate menus.
OK	Confirms an entry or selection.
▶ 	Starts, pauses or resumes play.
■	Stops play.
⏮ / ▶	Skips to the previous or next track, chapter or file.
⏪ / ⏩	Fast backwards or fast forwards. Press repeatedly to change the search speed.
ZOOM	Zooms into a video scene or picture.

Use video options

Access several useful features while viewing video.

Note

- Available video options depend on the video source.

Button	Action
▲ / ▼	Searches slow-backward or slow-forward. Press repeatedly to change the search speed. For VCD/SVCD, slow-backward search is not available.
AUDIO SYNC	Selects an audio language or channel.
SUBTITLE	Selects subtitle language for video.
ⓘ INFO	Displays information about what is playing.
REPEAT	Repeats a chapter or title.

Use picture options

Access several useful features while viewing pictures.

Button	Action
▲ / ▼	Flips the photo vertically or horizontally.
◀ / ▶	Rotates the picture counter-clockwise or clockwise.
⏪ / ⏩	Skips to the previous or next picture.
REPEAT	Repeats a single file in the folder or repeats the entire folder.
ⓘ INFO	Displays photo albums in a thumbnail overview.

Use audio options

Access several useful features while audio is played.

Button	Action
REPEAT	Repeats a track or the entire disc.

Use karaoke options

Access several useful features while playing karaoke disc.

Note

- Ensure that a microphone (not supplied) is connected to the **MIC** connector on this home theater before play.
- Set the microphone volume to the minimum level before connecting the microphone to prevent howling.

Button	Action
KARAOKE	Toggles through various karaoke options. [Mic Off]/[Mic On] – Press ◀▶ to turn on or off the microphone output. [Vol 20] – Press ◀▶ to set the default microphone volume level. [Echo +15] – Press ◀▶ to set the echo level. [Key] – Press ◀▶ to set the pitch level that match your voice. [Karaoke Scoring] – Press ◀▶ to set karaoke scoring when playback a DVD or VCD.
MIC VOL +/-	Increases or decreases microphone volume.
VOCAL	Turns off or on the vocal by changing the audio channel.

Play from a USB storage device

The home theater is fitted with a USB connector that allows you to view pictures, listen to music or watch movies stored on a USB storage device.

- 1 Connect the USB storage device to the home theater.
- 2 Press **USB**.
↳ A content browser appears.
- 3 Select a file, then press **OK**.
- 4 Press the playback buttons to control play (see 'Play a disc' on page 10).

Note

- If the USB storage device does not fit into the connector, use a USB extension cable.
- The home theater does not support digital cameras that need a computer program to display photos.
- The USB storage device must be FAT or DOS-formatted, and Mass Storage Class compliant.

More play features for disc or USB

Several advanced features are available for video or picture playback from a disc or USB storage device.

Play a musical slideshow

Play music and pictures simultaneously to create a musical slideshow. The files must be stored on the same disc or USB storage device.

- 1 Select a music track, then press **OK**.
- 2 Press **↩ BACK** and go to the picture folder.
- 3 Select a picture, then press **OK** to start slideshow.
- 4 Press **■** to stop slideshow.
- 5 Press **■** again to stop music.

Synchronize audio with video

If the audio and video are not synchronized, you can delay the audio to match the video.

- 1 Press and hold **AUDIO SYNC** until the audio sync message appears on the display panel.
- 2 Press **+/-** within five seconds to sync the audio with your video.

Quick skip play to a specific time

Quick skip to a specific part of a video by entering the time of a scene.

- 1 During video play, press **ⓘ INFO**.
- 2 Press the **Navigation buttons** and **OK** to select:
 - **[TT Time]** : Title time.
 - **[Ch Time]** : Chapter time.
 - **[Disc Time]** : Disc time.
 - **[Track Time]** : Track time.
- 3 Enter the time of the scene, then press **OK**.

Repeat play a specific section

Select sections of audio or video for repeat playback.

- 1 During playback, press **ⓘ INFO**.
- 2 Select **[Repeat AB]** in the menu.
- 3 Press **OK** to mark the start point.
- 4 Press **OK** again to mark the end point.
 - ↳ Repeat play starts.
 - To cancel repeat A-B, press **ⓘ INFO**, select **[Repeat AB] > [Off]**, then press **OK**.

Note

- Repeat play is only possible within a track/ chapter.

Play from radio

The home theater can store up to 40 radio stations.

- 1 Check that the FM antenna is connected.
- 2 Press **RADIO**.
 - ↳ "AUTO INSTALL...PRESS PLAY" appears on the display panel if you have not installed any radio stations. Press **▶||**
- 3 Press the following buttons to control play:

Button	Action
◀/▶	Selects a preset radio station.
◀◀/▶▶	Searches for a radio station.
▲▼	Fine tunes a radio frequency.
■	Press and hold to erase the preset radio station. Press to stop the installation of radio stations.
PROGRAM	Manual: Press once to access program mode, and press again to store the radio station. Automatic: Press and hold for five seconds to reinstall radio stations.

Note

- AM and digital radio are not supported.
- If no stereo signal is detected, you are prompted to install the radio stations again.
- For the best reception, place the antenna away from the TV or other sources of radiation.

Change tuning grid

In some countries, you can switch the FM tuning grid between 50 kHz and 100 kHz. Changing tuning grid erases all preset radio stations.

- 1 Press **RADIO**.
- 2 Press **■**.
- 3 Press and hold **▶▶** until 'GRID 9' (50 kHz) or 'GRID 10' (100 kHz) is displayed.

Play audio from TV or other devices

Press **AUDIO SOURCE** repeatedly to select the audio output of the connected device (see 'Connect audio from TV or other devices' on page 9).

Create MP3 audio files

Use the home theater to convert audio CDs into MP3 audio files.

- 1 Insert an audio CD (CDDA/HDCD) into the home theater.

- 2 Connect a USB storage device to the home theater.
- 3 When audio is played, press **CREATE MP3**.
- 4 Select **[Yes]** and press **OK** to confirm.

CREATE MP3			
OPTIONS		TRACK	
Speed	Normal	<input type="radio"/> Track01	04:14
Bitrate	128kbps	<input type="radio"/> Track02	04:17
CRT ID3	Yes	<input type="radio"/> Track03	03:58
Device	USB1	<input type="radio"/> Track04	04:51
SUMMARY		<input type="radio"/> Track05	03:53
		<input type="radio"/> Track06	04:09
Select Track	0	<input type="radio"/> Track07	04:38
Time	00:00	▼	
Start	Exit	Select All	Deselect All

- 5 Select the settings in the **[OPTIONS]** panel, then press **OK**.
 - **[Speed]** : Selects the write-to-file speed.
 - **[Bitrate]** : Selects the conversion quality.
 - **[CRT ID3]** : Copies information on the tracks in the MP3 files.
 - **[Device]** : Selects the USB device which you use to store the MP3 files.
- 6 Press **▶** to access the **[TRACK]** panel.
- 7 Select an audio track, then press **OK**.
 - **[Select All]** : Selects all tracks.
 - **[Deselect all]** : De-selects all tracks.
- 8 Select **[Start]** in the menu to convert, then press **OK**.
 - ↳ A new folder is created in the USB storage device to store all the new MP3 audio files.
 - To exit the menu, select **[Exit]** and press **OK**.

Note

- During the conversion process, do not press any buttons.
- DTS CDs and copy-protected CDs cannot be converted.
- Write-protected or password-protected USB storage device cannot be used to store MP3 files.

6 Change settings





This section helps you to change the settings of your home theater.



Caution

- Most of the settings are already configured with the best value for the home theater. Unless you have a specific reason to change a setting, it is best to leave it at the default value.

Access the setup menu

- 1 Press  **SETUP**.
↳ The following menu appears.

Symbol	Description
	[General Setup]
	[Audio Setup]
	[Video Setup]
	[Preference Setup]

- 2 Select a setup menu, then press **OK**.
See the following sections for information about how to change the settings of your home theater.
- 3 Press  **BACK** to return to the previous menu, or press  **SETUP** to exit.

Note

- You cannot change a setting that is grayed out.

Change general settings

- 1 Press  **SETUP**.
- 2 Select [**General Setup**], then press **OK**.
- 3 Select and adjust the following settings:
 - [**Disc Lock**] : Restricts play to disc. Password (PIN code) is required to unlock the disc before play.
 - [**Display Dim**] : Changes the brightness of the display panel.
 - [**OSD Language**] : Selects the on-screen display menu language.
 - [**Screen Saver**] : Enables or disables screen saver mode. If enabled, the screen enters idle mode after 10 minutes of inactivity (for example, in pause or stop mode).
 - [**Sleep Timer**] : Sets a sleep timer to switch the home theater to standby after a specific time.
 - [**Auto Standby**] : Enables or disables auto standby. If enabled, the home theater switches to standby after 30 minutes of inactivity (for example, in pause or stop mode).
 - [**DivX(R) VOD Code**] : Displays the DivX VOD registration code for the home theater.
- 4 Press **OK** to confirm your choice.

Note

- Before you purchase DivX videos and play them on the home theater, register the home theater on www.divx.com using the DivX VOD code.

Change audio settings

- 1 Press  **SETUP**.
- 2 Select [**Audio Setup**], then press **OK**.
- 3 Select and adjust the following settings:
 - [**Speakers Volume**] : Sets the volume of each speaker to obtain the ideal audio balance.
 - [**Speakers Delay**] : Sets the delay time for center and rear speakers to obtain an equal audio transmission from all the speakers.

- **[HDMI Audio]** : Enables or disables HDMI audio output for the TV.
- **[Audio Sync]** : Sets a delay for audio output when you play a video disc.
- **[Prologic II Mode]** : Selects a 5.1 surround sound mode to suit your video or music.

4 Press **OK** to confirm your choice.

Note

- For settings related to HDMI, the TV must be connected through HDMI.

Change video settings

1 Press **⏏** **SETUP**.

2 Select **[Video Setup]**, then press **OK**.

3 Select and adjust the following settings:

- **[TV System]** : Selects a TV system that is compatible with the TV.
- **[TV Display]** : Selects a picture display format to fit the TV screen.
- **[Picture Settings]** : Selects a predefined color setting.
- **[HDMI Setup]** : Selects HDMI video resolution and the wide screen display format for the TV. The Wide Screen Display option is only available for 16:9 wide screen TV display setting.
- **[Progressive]** : Enables or disables progressive scan mode.
- **[HD JPEG]** : Enables or disables display of high definition JPEG images.

4 Press **OK** to confirm your choice.

Note

- The best setting is automatically selected for the TV. If you need to change the setting, ensure that the TV supports the new setting.
- Some video settings depend on the video source, ensure that the disc and the TV support the setting or feature.
- For settings related to HDMI, the TV must be connected through HDMI.
- For settings related to progressive or component video, the TV must be connected through Component Video.

Change preference settings

1 Press **⏏** **SETUP**.

2 Select **[Preference Setup]**, then press **OK**.

3 Select and adjust the following settings:

- **[Audio]** : Selects audio language for video.
- **[Subtitle]** : Selects subtitle language for video.
- **[Disc Menu]** : Selects menu language for video disc.
- **[Parental]** : Restricts access to discs that are recorded with ratings. To play all discs irrespective of the rating, select level '8'.
- **[PBC]** : Displays or skips the content menu for VCD and SVCD discs.
- **[MP3/JPEG Display]** : Displays the MP3/JPEG folders or all the files.
- **[Password]** : Sets or changes a PIN code to play a restricted disc. Enter '0000' if you do not have a PIN or if you have forgotten your PIN.
- **[DivX Subtitle]** : Selects a character set that supports the DivX subtitle.
- **[Version Info.]** : Displays the software version for the home theater.
- **[Default]** : Resets the home theater to the default settings programmed at the factory.

4 Press **OK** to confirm your choice.

Note

- If your preferred disc language is not available, you can select **[Others]** from the list and enter the 4-digit language code which can be found at the back of this manual.
- If you select a language that is not available on a disc, the home theater uses the default language of the disc.
- You cannot reset disc lock, password (PIN code) and parental control settings to their default values.

7 Update software

To check for new updates, compare the current software version of your home theater with the latest software version (if available) on the Philips web site.

Check software version

- 1 Press **SETUP**.
- 2 Select **[Preference Setup] > [Version Info.]**, then press **OK**.
↳ The software version is displayed.

Update software from a CD-R or USB

- 1 Check for the latest software version on www.philips.com/support.
 - Search for your model and click on 'software&drivers'.
 - 2 Download the software onto a CD-R or USB storage device.
 - 3 Insert the CD-R or connect the USB storage device to the home theater.
 - 4 Follow the instructions on the TV to confirm the update.
↳ When complete, the home theater automatically switches off and on again.
- If not, disconnect the power cord for a few seconds and then reconnect it.

Caution

- Do not turn off the power or remove the CD-R or USB storage device when the software update is in progress because you might damage the home theater.

8 Product specifications

Note

- Specification and design are subject to change without notice.

Region code

The type plate on the back or bottom of the home theater shows which regions it supports

Country	DVD
Europe, United Kingdom	
Asia Pacific, Taiwan, Korea	
Latin America	
Australia, New Zealand	
Russia, India	
China	

Playback media

DVD-Video, DVD+R/+RW, DVD-R/-RW, DVD+R DL, CD-R/CD-RW, Audio CD, Video CD/SVCD, Picture CD, MP3-CD, WMA-CD, DivX-CD, USB storage device

File Format

- Audio: .mp3, .wma
- Video: .divx, .divx ultra, .mpeg, .mpg
- Picture: .jpeg, .jpg

Amplifier

- Total output power:
 - HTS3510: 300 W RMS (30% THD)
 - HTS3520: 600 W RMS (30% THD)
- Frequency response: 20 Hz-20 kHz
- Signal-to-noise ratio: > 65 dB (CCIR) / (A-weighted)
- Input sensitivity:
 - AUX: 2 V

Video

- Signal system: PAL / NTSC
- HDMI output: 480i/576i, 480p/576p, 720p, 1080i, 1080p

Audio

- Sampling frequency:
 - MP3: 32 kHz, 44.1 kHz, 48 kHz
 - WMA: 44.1 kHz, 48 kHz
- Constant bit rate:
 - MP3: 112 kbps - 320 kbps
 - WMA: 64 kbps - 192 kbps

Radio

- Tuning range: FM 87.5-108 MHz (50/100 kHz)
- Signal-to-noise ratio: FM 50 dB
- Frequency response: FM 180 Hz-10 kHz

USB

- Compatibility: Hi-Speed USB (2.0)
- Class support: UMS (USB Mass Storage Class)
- File system: FAT12, FAT16, FAT32
- Maximum memory support: < 160GB

Main Unit

- Power supply:
 - Latin America/Asia Pacific: 110-240V, ~50-60Hz
 - China/Russia/India: 220-240V, ~50Hz
- Power consumption:
 - HTS3510: 60 W
 - HTS3520: 100 W
- Standby power consumption: ≤ 0.9 W
- Dimensions (WxHxD): 360 x 58 x 320 (mm)
- Weight: 2.84 kg

Subwoofer

- Impedance: 8 ohm
- Speaker drivers: 165 mm (6.5") woofer
- Dimensions (WxHxD): 122.6 x 307 x 369 (mm)
- Weight: 3.84 kg
- Cable length: 3 m

Speakers

- System: full range satellite
- Speaker impedance: 8 ohm (center), 4 ohm (Front/Rear)
- Speaker drivers: 3" full range
- Frequency response: 150 Hz-20 kHz
- Dimensions (WxHxD):
 - Center: 160.9 x 95 x 92 (mm)
 - Front/Rear: 95 x 160.9 x 87 (mm)
- Weight:
 - Center: 0.77 kg
 - HTS3510 - Front/Rear: 0.56 kg/each
 - HTS3520 - Front/Rear: 0.68 kg/each
- Cable length:
 - Center: 2 m
 - Front: 3 m
 - Rear: 10 m

Laser specification

- Type: Semiconductor laser GaAlAs (CD)
- Wave length: 645 - 665 nm (DVD), 770 - 800 nm (CD)
- Output power: 6 mW (DVD), 7 mW (VCD/CD)
- Beam divergence: 60 degrees.

9 Troubleshooting



Warning

- Risk of electric shock. Never remove the casing of the product.

To keep the warranty valid, never try to repair the product yourself.

If you have problems using this product, check the following points before you request service. If you still have a problem, register your product and get support at www.philips.com/welcome.

If you contact Philips, you will be asked for the model and serial number of your product. The model number and serial number are on the back or bottom of your product. Write the numbers here:

Model No. _____

Serial No. _____

Main unit

The buttons on this home theater do not work.

- Disconnect the home theater from the power outlet for a few minutes, then reconnect.

Picture

No picture.

- Ensure that the TV is switched to the correct source for this home theater.
- If this happens when you change the TV system, switch to its default mode: 1) Press **▲** to open the disc compartment. 2) Press the **Numeric buttons '3'**.
- If this happens when you switch on the progressive scan mode, switch to its default mode: 1) Press **▲** to open the disc compartment. 2) Press the **Numeric buttons '1'**.

No picture on HDMI connection.

- Check if the HDMI cable is faulty. Replace with a new HDMI cable.
- If this happens when you change the HDMI video resolution, switch to its default mode: 1) Press **▲** to open the disc compartment. 2) Press the **Numeric buttons '1'**.

Sound

No sound.

- Ensure that the audio cables are connected and select the correct input source (for example, **AUDIO SOURCE**) for the device you want to play.

No sound on HDMI connection.

- You might not hear any sound if the connected device is not HDCP (High-bandwidth Digital Content Protection) compliant or only DVI compatible. Use an analog or digital audio connection.
- Ensure that the **[HDMI Audio]** is enabled.

No sound from TV program.

- Connect an audio cable from the audio input on the home theater to the audio output on the TV, then press **AUDIO SOURCE** repeatedly to select the correct audio source.

Distorted sound or echo.

- Ensure that the TV volume is muted or set to minimum if you are playing audio through the home theater.

Audio and video are not synchronized.

- 1) Press and hold **AUDIO SYNC**. 2) Press **+/-** within five seconds.

Play

Disc cannot be played.

- Clean the disc.
- Ensure that the home theater supports the disc (see 'Product specifications' on page 16).
- Ensure that the home theater supports the region code of the DVD.
- For DVD±RW or DVD±R, ensure that the disc is finalized.

DivX video files cannot be played.

- Ensure that the DivX file is encoded according to the 'Home Theater Profile' with the DivX encoder.
- Ensure that the DivX video file is complete.

DivX subtitles do not display correctly.

- Ensure that the subtitle file name is the same as the movie file name.
- Select the correct character set: 1) Press **⏏** **SETUP**. 2) Select **[Preference Setup]**. 3) Select **[DivX Subtitle]**. 4) Select a supported character set. 5) Press **OK**.

The contents of a USB storage device cannot be read.

- Ensure that the format of the USB storage device is compatible with the home theater (see 'Product specifications' on page 16).
- Ensure that the USB storage device is formatted with a file system that is supported by the home theater (note that NTFS is not supported).

'No entry' or 'x' sign appears on the TV.

- The operation is not possible.

10 Index

A

amplifier	16
audio	
connection	9
language	11, 15
synchronize with video	12

C

care	5
change settings	14
connect	
audio from TV	9, 13
guide	8
microphone	9
other devices	9
TV	8
connectors	8
contact us	18

D

disc	
play	10
supported discs	16
disposal of your product	6
DivX	
subtitle	15

F

file formats	16
---------------------	----

K

karaoke	
microphone	9

L

language	
audio	15
disc menu	15
on-screen display	14
subtitle	15

M

MP3	
create MP3 files	13

O	
overview	
connectors	8
main unit	6
remote control	7

P	
password	15
picture	
slide show	12
troubleshooting	18
play	
disc	10
options	10
radio	12
troubleshooting	18
USB storage device	11
product care	5
product specifications	16
progressive scan	4

R	
radio	
play	12
program	12
tune	12
tuning grid	13
recycle	6
region code	16
remote control	7
repeat	10, 12

S	
safety	5
settings	
general	14
parental control	15
preferences	15
restore factory settings	15
video	15
slideshow	
play musical slideshow	12
software	
update	16
version	16
sound	
mode	10
surround	10
troubleshooting	18
subtitle	
language	11

T	
time search video	12
troubleshooting	18
TV	
audio from TV	9, 13
connect	8

U	
USB	
play	11
software update	16

V	
video	
options	11
settings	15
synchronize with audio	12

Language Code

Abkhazian	6566
Afar	6565
Afrikaans	6570
Amharic	6577
Arabic	6582
Armenian	7289
Assamese	6583
Avestan	6569
Aymara	6589
Azerhijani	6590
Bahasa Melayu	7783
Bashkir	6665
Belarusian	6669
Bengali	6678
Bihari	6672
Bislama	6673
Bokmål, Norwegian	7866
Bosanski	6683
Brezhoneg	6682
Bulgarian	6671
Burmese	7789
Castellano, Español	6983
Catalán	6765
Chamorro	6772
Chechen	6769
Chewa; Chichewa; Nyanja	7889
中文	9072
Chuang; Zhuang	9065
Church Slav; Slavonic	6785
Chuvash	6786
Corsican	6779
åesky	6783
Dansk	6865
Deutsch	6869
Dzongkha	6890
English	6978
Esperanto	6979
Estonian	6984
Euskara	6985
äÏËÓËÏ	6976
Faroese	7079
Français	7082
Frysk	7089
Fijian	7074
Gaelic; Scottish Gaelic	7168
Gallegan	7176
Georgian	7565
Gikuyu; Kikuyu	7573
Guarani	7178
Gujarati	7185
Hausa	7265
Herero	7290
Hindi	7273
Hiri Motu	7279
Hrwatski	6779
Ido	7379
Interlingua (International)	7365
Interlingue	7365
Inuktitut	7385

Inupiaq	7375
Irish	7165
Íslenska	7383
Italiano	7384
Ivrit	7269
Japanese	7465
Javanese	7486
Kalaallisut	7576
Kannada	7578
Kashmiri	7583
Kazakh	7575
Kernewek	7587
Khmer	7577
Kinyarwanda	8287
Kirghiz	7589
Komi	7586
Korean	7579
Kuanyama; Kwanyama	7574
Kurdish	7585
Lao	7679
Latina	7665
Latvian	7686
Letzeburgesch;	7666
Limburgan; Limburger	7673
Lingala	7678
Lithuanian	7684
Luxembourgish;	7666
Macedonian	7775
Malagasy	7771
Magyar	7285
Malayalam	7776
Maltese	7784
Manx	7186
Maori	7773
Marathi	7782
Marshallese	7772
Moldavian	7779
Mongolian	7778
Nauru	7865
Navaho; Navajo	7886
Ndebele, North	7868
Ndebele, South	7882
Ndonga	7871
Nederlands	7876
Nepali	7869
Norsk	7879
Northern Sami	8369
North Ndebele	7868
Norwegian Nynorsk;	7878
Occitan; Provençal	7967
Old Bulgarian; Old Slavonic	6785
Oriya	7982
Oromo	7977
Ossetian; Ossetic	7983
Pali	8073
Panjabi	8065
Persian	7065
Polski	8076
Português	8084

Pushto	8083
Russian	8285
Quechua	8185
Raeto-Romance	8277
Romanian	8279
Rundi	8278
Samoan	8377
Sango	8371
Sanskrit	8365
Sardinian	8367
Serbian	8382
Shona	8378
Shqip	8381
Sindhi	8368
Sinhalese	8373
Slovensky	8373
Slovenian	8376
Somali	8379
Sotho; Southern	8384
South Ndebele	7882
Sundanese	8385
Suomi	7073
Swahili	8387
Swati	8383
Svenska	8386
Tagalog	8476
Tahitian	8489
Tajik	8471
Tamil	8465
Tatar	8484
Telugu	8469
Thai	8472
Tibetan	6679
Tigrinya	8473
Tonga (Tonga Islands)	8479
Tsonga	8483
Tswana	8478
Türkçe	8482
Türkmen	8475
Twi	8487
Uighur	8571
Ukrainian	8575
Urdu	8582
Uzbek	8590
Vietnamese	8673
Volapuk	8679
Walloon	8765
Welsh	6789
Wolof	8779
Xhosa	8872
Yiddish	8973
Yoruba	8979
Zulu	9085

