

Always there to help you

Register your product and get support at
www.philips.com/support

NTX401



User manual

PHILIPS

Contents

1 Important	2
Safety	2

2 Your Mini Hi-Fi System	4
Introduction	4
What's in the box	4
Overview of the main unit	5
Overview of the remote control	6

3 Get started	8
Connect	8
Prepare the remote control	8
Connect power	9
Set clock	9
Turn on	9

4 Play from a disc or USB	10
Play a disc	10
Play from a USB storage device	10
Control play	10
Program tracks	11
View play information	11

5 Play audio through Bluetooth	12
Connect a device	12
Play from Bluetooth device	12
Disconnect a device	13

6 Listen to radio	14
Store radio stations automatically	14
Tune to a radio station	14
Store radio stations manually	14
Select a preset radio station	15
Change AM tuning grid	15

7 Adjust sound	16
Adjust volume	16
Mute sound	16
Select a preset sound effect	16
Enhance bass	16
Apply NX Bass effect	16

8 Other features	17
Listen to an external device	17
Record to a USB device	17
Set the timer	18
Set sleep timer	18
Turn decorative light on or off	19
Listen through a headphone	19

9 Product information	20
Specifications	20
USB playability information	21
Supported MP3 disc formats	21
Maintenance	21

10 Troubleshooting	22
About Bluetooth device	22

11 Notice	23
Care of the environment	23
Trademark notice	23

1 Important

Safety

Know these safety symbols



This 'bolt of lightning' indicates uninsulated material within your unit may cause an electrical shock. For the safety of everyone in your household, please do not remove product covering.

The 'exclamation point' calls attention to features for which you should read the enclosed literature closely to prevent operating and maintenance problems.

WARNING: To reduce the risk of fire or electric shock, this apparatus should not be exposed to rain or moisture and objects filled with liquids, such as vases, should not be placed on this apparatus.

CAUTION: To prevent electric shock, match wide blade of plug to wide slot, fully insert.

Warning

- Never remove the casing of this device.
- Never lubricate any part of this device.
- Never place this device on other electrical equipment.
- Keep this device away from direct sunlight, naked flames or heat.
- Never look into the laser beam inside this device.
- Ensure that you always have easy access to the power cord, plug, or adaptor to disconnect this device from the power.

- Do not use this apparatus near water.
- Install in accordance with the manufacturer's instructions.

- Do not install near any heat sources such as radiators, heat registers, stoves, or other apparatus (including amplifiers) that produce heat.
- Protect the power cord from being walked on or pinched, particularly at plugs, convenience receptacles, and the point where they exit from the apparatus.
- Only use attachments/accessories specified by the manufacturer.
- Use only with the cart, stand, tripod, bracket, or table specified by the manufacturer or sold with the apparatus. When a cart is used, use caution when moving the cart/apparatus combination to avoid injury from tip-over.



- Unplug this apparatus during lightning storms or when unused for long periods of time.
- Refer all servicing to qualified service personnel. Servicing is required when the apparatus has been damaged in any way, such as power-supply cord or plug is damaged, liquid has been spilled or objects have fallen into the apparatus, the apparatus has been exposed to rain or moisture, does not operate normally, or has been dropped.
- Battery usage **CAUTION** – To prevent battery leakage which may result in bodily injury, property damage, or damage to the remote control:
 - Install the battery correctly, + and - as marked on the remote control.
 - Do not mix batteries (old and new or carbon and alkaline, etc.).
 - Remove the battery when the remote control is not used for a long time.
- The battery shall not be exposed to excessive heat such as sunshine, fire or the like.

- Apparatus shall not be exposed to dripping or splashing.
- Do not place any sources of danger on the apparatus (e.g. liquid filled objects, lighted candles).
- Where the MAINS plug or an appliance coupler is used as the disconnect device, the disconnect device shall remain readily operable.

! **Caution**

- Use of controls or adjustments or performance of procedures other than herein may result in hazardous laser exposure or other unsafe operation.

Hearing safety



Listen at a moderate volume.

- Using headphones at a high volume can impair your hearing. This product can produce sounds in decibel ranges that may cause hearing loss for a normal person, even for exposure less than a minute. The higher decibel ranges are offered for those that may have already experienced some hearing loss.
- Sound can be deceiving. Over time your hearing 'comfort level' adapts to higher volumes of sound. So after prolonged listening, what sounds 'normal' can actually be loud and harmful to your hearing. To guard against this, set your volume to a safe level before your hearing adapts and leave it there.

To establish a safe volume level:

- Set your volume control at a low setting.
- Slowly increase the sound until you can hear it comfortably and clearly, without distortion.

Listen for reasonable periods of time:

- Prolonged exposure to sound, even at normally 'safe' levels, can also cause hearing loss.
- Be sure to use your equipment reasonably and take appropriate breaks.

Be sure to observe the following guidelines when using your headphones.

- Listen at reasonable volumes for reasonable periods of time.
- Be careful not to adjust the volume as your hearing adapts.
- Do not turn up the volume so high that you can't hear what's around you.
- You should use caution or temporarily discontinue use in potentially hazardous situations.

≡ **Note**

- The type plate is located on the back of the unit.

2 Your Mini Hi-Fi System

Congratulations on your purchase, and welcome to Philips! To fully benefit from the support that Philips offers, register your product at www.Philips.com/welcome.

Introduction

With this product, you can

- enjoy audio from discs, USB storage devices, Bluetooth enabled devices, or other external devices;
- listen to FM and AM radio stations; and
- record from a disc to a USB storage device.

To enrich sound, this product offers you these sound effects:

- Preset Equalizer (EQ) Settings
- Dynamic Bass Boost (DBB)
- NX Bass Enhancement

What's in the box

Check and identify the contents of your package:

- Main unit x 1
- Remote control (with one AAA battery)
- FM wire antenna x 1
- AM loop antenna x 1
- Quick start guide x 1

Overview of the main unit

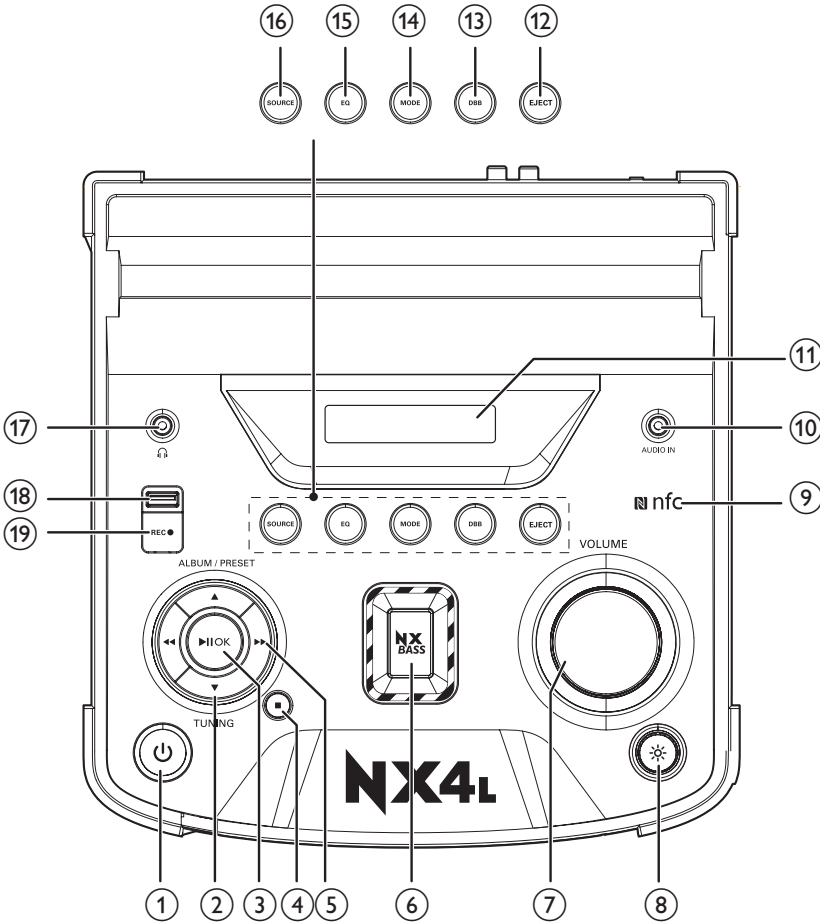

- ① Turn on the product.
 • Switch to standby or Eco power standby mode.
- ② In Disc or USB mode, skip to the previous or next album.
 • In FM or AM tuner mode, select a preset radio station.
 • In standby mode, adjust hour and minute during clock/timer setting.
- ③ **▶||/OK**
 • Pause or resume play.
 • Confirm a selection.
 • In AM tuner mode, change AM tuning grid.
- ④ **■**
 • Stop play or erase programmed list.
 • Exit clock/timer setting mode.
 • Exit the recording process.

- ⑤ ◀◀ / ▶▶
- In tuner mode, tune to radio stations.
 - In DISC or USB mode, skip to the previous or next track.
 - In DISC or USB mode, search within a track.

- ⑥ NX BASS
- Turn bass effect on.

- ⑦ Volume knob
- Adjust volume.

- ⑧ ✨
- Enable or disable the speaker lighting effect.

- ⑨ NFC
- Connect a NFC compatible device through Bluetooth.

- ⑩ AUDIO IN
- Connect an external audio device.

- ⑪ Display panel
- Show current status.

- ⑫ EJECT
- Open or close the disc tray.

- ⑬ DBB
- Turn dynamic bass enhancement on or off.

- ⑭ MODE
- Select a repeat or shuffle play mode.

- ⑮ EQ
- Select a preset equalizer (EQ) setting.

- ⑯ SOURCE
- Select an audio source.

- ⑰ 🎧
- Connect a headphone.



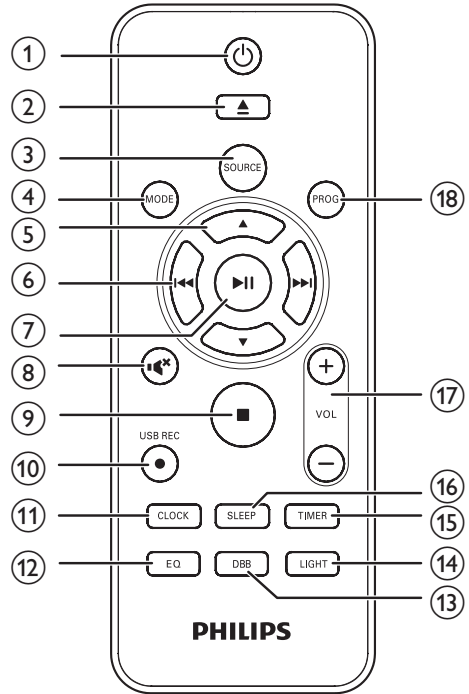

- ⑱ USB socket
- Connect a USB mass storage device.

- ⑲ REC
- Record to a USB device.

Overview of the remote control



- ① ⏻
- Turn on the product.
 - Switch to standby or Eco power standby mode.
- ② ▲
- Open or close the disc tray.
- ③ SOURCE
- Select an audio source.
- ④ MODE
- Select a repeat or shuffle play mode.
- ⑤ ▲ / ▼
- In Disc or USB mode, skip to the previous or next album.
 - In FM or AM tuner mode, select a preset radio station.
 - In standby mode, adjust hour and minute during clock/timer setting.

- ⑥ 
- In FM or AM tuner mode, tune to radio stations.
 - In DISC or USB mode, skip to the previous or next track.
 - In DISC or USB mode, search within a track.
- ⑦ 
- Pause or resume play.
 - Confirm a selection.
 - In AM tuner mode, change AM tuning grid.
- ⑧ 
- Mute or resume sound.
- ⑨ 
- Stop play or erase programmed list.
 - Exit clock/timer setting mode.
 - Exit the recording process.
- ⑩ **USB REC**
- Record to a USB device.
- ⑪ **CLOCK**
- Set clock.
- ⑫ **EQ**
- Select a preset equalizer (EQ) setting.
- ⑬ **DBB**
- Turn dynamic bass enhancement on or off.
- ⑭ **LIGHT**
- Enable or diable the speaker lighting effect.
- ⑮ **TIMER**
- Set the timer.
- ⑯ **SLEEP**
- Set sleep timer.
- ⑰ **+VOL -**
- Adjust volume.
- ⑱ **PROG**
- Program tracks.
 - Program radio stations.

3 Get started

! Caution

- Use of controls or adjustments or performance of procedures other than herein may result in hazardous laser exposure or other unsafe operation.

Always follow the instructions in this chapter in sequence.

If you contact Philips, you will be asked for the model and serial number of this apparatus. The model number and serial number are on the back of the apparatus. Write the numbers here:
Model No. _____
Serial No. _____

Connect

Connect FM antenna

≡ Note

- For better reception, fully extend and adjust the position of the FM antenna.

Connect the supplied FM antenna to the **FM** jack on the back of the main unit.

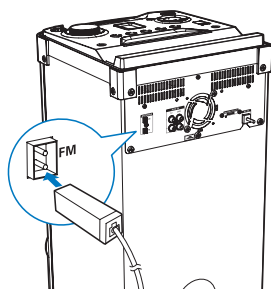

Connect AM antenna

≡ Note

- For better reception, adjust the position of the AM antenna.

1 Assemble the AM loop antenna.

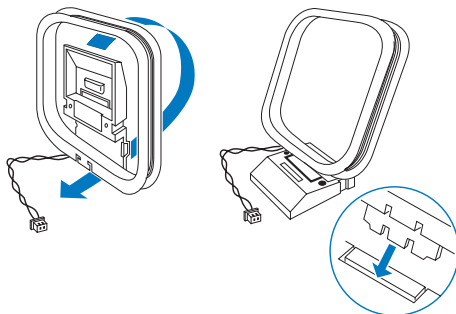

2 Connect the AM loop antenna to the **AM** jack on the back of the main unit.

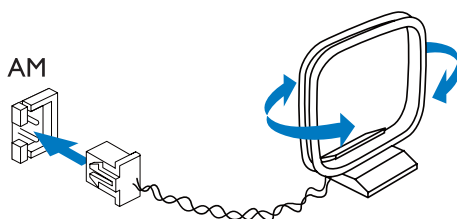

Prepare the remote control

≡ Note

- Danger of explosion if battery is incorrectly replaced. Replace only with the same or equivalent type.
- Batteries contain chemical substances, so they should be disposed of properly.

- 1 Open the battery compartment.
- 2 Insert one AAA battery with correct polarity (+/-) as indicated.

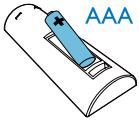

- 3 Close the battery compartment.

Connect power

! Caution

- Risk of product damage! Make sure that the power supply voltage corresponds to the voltage printed on the back or the underside of the product.
- Risk of electric shock! When you unplug the power cord, always pull the plug from the socket. Never pull the cord.

☰ Note

- Before connecting to AC power, make sure that you have completed all other connections.

- 1 Adjust the voltage selector on the back of the main unit to match your local power supply.

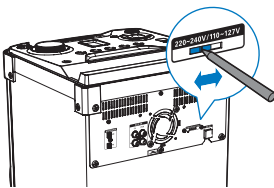

- 2 Connect the AC power plug to the power outlet.

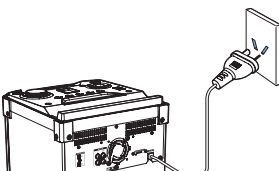

Set clock

- 1 In standby mode, press and hold **CLOCK** for two seconds.
↳ **[CLOCK SET]** appears, then **[12H]** or **[24H]** is displayed.
- 2 Press **▲** / **▼** repeatedly to select 12 hour or 24 hour format.
- 3 Press **CLOCK** to confirm.
↳ The hour digit flashes.
- 4 Repeat steps 2 to 3 to set the hour and minute.

☰ Note

- To cancel clock setting, press **■**.
- During clock setting, if no action is taken within 90 seconds, the product exits clock setting mode automatically.
- The clock is displayed in standby mode. To view the clock in working or ECO power standby mode, press and hold **CLOCK** for two seconds.

Turn on

Press **⏻**.

- ↳ The product switches to the last selected source.

Switch to standby mode

Press **⏻** again to switch the product to standby mode.

- ↳ The clock (if set) is displayed.

To switch between standby mode and Eco power standby mode:

Press and hold **⏻** for two seconds.

- ↳ In Eco power standby mode, the **⏻** button lights up red, and the display backlight is off.

✦ Tip

- The product switches to Eco power standby mode automatically after 10 minutes in standby mode.

4 Play from a disc or USB

Play a disc

Note

- Make sure that the disc contains playable audio contents.

- 1 Press **SOURCE** repeatedly to select the disc source.
- 2 Press **▲** to open the disc tray.
- 3 Insert a disc into the disc tray, with the printed side facing up.

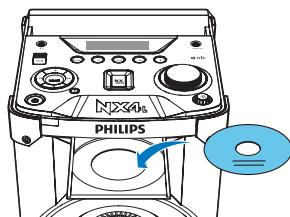

- 4 Press **▲** again to close the disc tray.
↳ Play starts automatically.

Play from a USB storage device

Note

- Make sure that the USB device contains playable audio contents in supported formats.

- 1 Press **SOURCE** repeatedly to select the USB source.

- 2 Insert the USB plug of the device into the  socket.

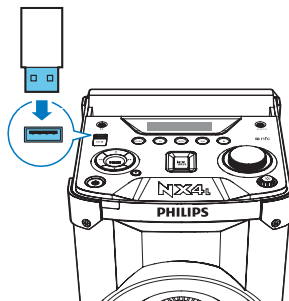

- 3 Press **▲** / **▼** to select a folder.
- 4 Press **◀◀** / **▶▶** to select an audio file.
↳ Play starts automatically.

Control play

In DISC or USB mode, follow the instructions below to control play.

Button	Action
◀◀ / ▶▶	Press to skip to the previous or next track. Press and hold to fast forward or fast reverse the track during playback, then release to resume play.
▲ / ▼	Press to select an album.
▶▶	Press to pause or resume play.
■	Press to stop play.
MODE	Press repeatedly to select a play mode: <ul style="list-style-type: none">• [OFF]: return to normal play mode.• [REPEAT ONE]: play the current track repeatedly.• [REPEAT ALL]: play all tracks repeatedly.• [SHUFFLE]: play all tracks randomly.

Note

- Random play cannot be selected when you play the programmed tracks.

Program tracks

You can program a maximum of 20 tracks.

- 1 In DISC or USB mode, press **■** to stop playing.
- 2 Press **PROG** to activate the program mode.
↳ A number flashes on the screen.
- 3 For MP3 tracks, press **▲** or **▼** to select an album.
- 4 Press **◀◀** or **▶▶** to select a track number, then press **PROG** to confirm selection.
- 5 Repeat steps 3 to 4 to program other tracks.
- 6 Press **▶||** to play the programmed track.
 - To erase the program, press **■** twice.

View play information



Note

- You can only view the play information in DISC or USB mode.

During play, press **CLOCK** repeatedly to view different play information (if available):

- Track number and play time
- Title
- Artist
- Album

5 Play audio through Bluetooth

The product can stream music from your Bluetooth device to the system through Bluetooth.

Connect a device

Note

- Before pairing a device with this product, read its user manual for Bluetooth compatibility.
- The product can memorize a maximum of eight paired devices. The ninth paired device will replace the first one.
- Any obstacle between this product and a Bluetooth device can reduce the operational range. Keep away from any other electronic device that may cause interference.
- The operational range between this product and a Bluetooth device is approximately 10 meters (30 feet).

Option 1: Connect a device through NFC

Near Field Communication (NFC) is a technology that enables short-range wireless communication between various NFC compatible devices, such as mobile phones and IC tags.

If your Bluetooth device supports NFC, you can connect it with this product easily.

- 1 Enable the NFC feature on your Bluetooth device (refer to its user manual).
- 2 Tap the NFC tag on the top of the product with the NFC area of your Bluetooth device until you hear a beep.

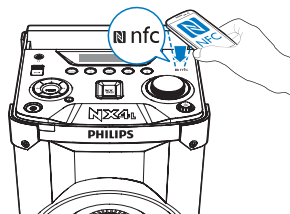

- 3 On your Bluetooth device, accept the pairing request with "Philips NX4L".
- 4 Follow the on-screen instructions to complete the pairing and connection.
 - ↳ After successful connection, **[BT CONNECTED]** (BT connected) scrolls on the screen, and the product beeps twice.

Option 2: Connect a device manually

- 1 Press **SOURCE** repeatedly to select **[BT]** source.
- 2 On your Bluetooth device, enable Bluetooth and search for Bluetooth devices that can be paired (see the user manual of the device).
- 3 Select **[Philips NX4L]** displayed on your device for pairing.
 - ↳ After successful connection, **[BT connected]** (BT connected) scrolls on the screen, and the product beeps twice.

Play from Bluetooth device

After successful Bluetooth connection, play audio on the Bluetooth device.

- ↳ Audio streams from your Bluetooth device to this product.

Disconnect a device

- Press and hold ►|| for three seconds;
- Disable Bluetooth on your device; or
- Move the device beyond the communication range.
 - ↳ The product beeps twice.



Note

- Before connecting another Bluetooth device, disconnect the current device first.

6 Listen to radio

Store radio stations automatically

Note

- You can program a maximum of 20 FM and 10 AM radio stations.
- When entering FM or AM mode for the first time, the product prompts you to search and store all the available radio stations.
 - 1 Press **SOURCE** repeatedly to select FM or AM tuner mode.
 - ↳ **[AUTO INSTALL-PRESS PLAY-STOP CANCEL]** is displayed.
 - 2 Press **▶|||** to start full scan.
 - ↳ **[AUTO]** is displayed.
 - ↳ The product stores all the available radio stations automatically, and then broadcasts the first available station.
 - ↳ The station list is memorized in the product. When you enter the radio mode next time, the station scan does not take place.

Note

- If you press **■** the product will not perform full scan, and the same message will pop up when you enter FM or AM mode next time.
- You can also press and hold **PROG** for two seconds to activate automatic programming.
 - ↳ **[AUTO]** is displayed.
 - ↳ The product stores radio stations with sufficient signal strength automatically.
 - ↳ The first stored radio station is broadcast automatically.

Tune to a radio station

Tip

- Keep the product away from other electronic devices to avoid radio interference.
- For better reception, fully extend and adjust the position of the antenna.

- 1 Press **SOURCE** repeatedly to select FM or AM tuner.
- 2 Press and hold **◀◀ / ▶▶** for two seconds.
 - ↳ **[SEARCH]** is displayed.
 - ↳ The radio tunes to a station with strong signal automatically.
- 3 Repeat step 2 to tune to more stations.
 - To tune to a station with weak signal, press **◀◀ / ▶▶** repeatedly until you find better reception.

Store radio stations manually

Note

- You can program a maximum of 20 FM and 10 AM radio stations.

- 1 Tune to a radio station.
- 2 Press **PROG** to activate the program mode.
 - ↳ A position number is displayed.
- 3 Press **▲ / ▼** to allocate a number to this radio station, then press **PROG** to confirm.
- 4 Repeat steps 1 to 3 to program other stations.

Tip

- To overwrite a programmed station, store another station in its place.

Select a preset radio station

In tuner mode, press ▲ / ▼ to select a preset number.

Change AM tuning grid

In some countries, the AM radio frequency step between adjacent channels is 10 kHz or 9 kHz.

- In AM tuner mode, press and hold ►|| for more than five seconds.
 - ↳ All preset stations are erased and need to be re-programmed.

7 Adjust sound

Adjust volume

During play, press **+VOL -** to increase or decrease volume.

Mute sound

During play, press **⏏** to mute or resume sound.

Select a preset sound effect

During play, press **EQ** repeatedly to select special sound effects:

- **[PARTY]**
- **[ROCK]**
- **[REGUETON]**
- **[HIP-HOP]**
- **[POP]**

Enhance bass

The best Dynamic Bass Enhancement (DBB) setting is generated automatically for each EQ selection. You can manually select the DBB setting that best suits your listening environment.

- During play, press **DBB** repeatedly to select:
 - **DBB 1**
 - **DBB 2**
 - **DBB 3**
 - **DBB OFF**

Apply NX Bass effect

NX Bass effect adds clean and lively characteristics to your music with rather low background noise.

- During play, press **NX BASS**. The sound will change in 3 stages:
 - Stage 1: The sound volume increases to a higher level and stays at this level for 5 seconds.
↳ **[FIRING]** is displayed.
 - Stage 2: The sound volume gradually decreases to its original level in 10 seconds.
↳ **[DISCHARGING]** is displayed.
 - Stage 3: The sound volume keeps at normal level for 40 seconds.
↳ **[RECHARGING]** is displayed.

Note

- To reactivate the NX bass effect, press **NX BASS** again after the 3 stages are completed.

8 Other features

Listen to an external device

With this product, you can listen to an external audio device such as an MP3 player:

Play from an MP3 player

- 1 Press **SOURCE** repeatedly to select the **AUDIO IN** source.
- 2 Connect an audio input cable (not supplied) with a 3.5 mm connector on both ends to:
 - the **AUDIO IN** socket on the product, and
 - the headphone socket on the MP3 player.
- 3 Play audio on the MP3 player (refer to its user manual).

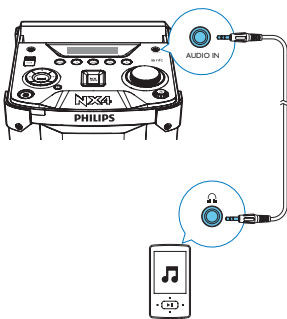

Play from other audio device

You can also play audio from a TV or DVD player:

- 1 Press **SOURCE** repeatedly to select **AUX DVD** or **AUX TV** source.

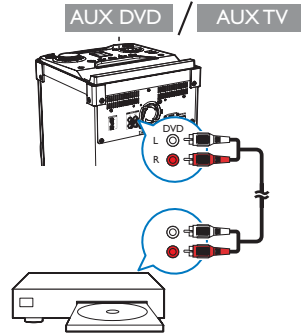

- 2 Connect the white and red audio cables (not supplied) to:
 - the **AUX IN** sockets on the back of the product.
 - the **AUDIO OUT** socket on a TV or DVD player.
- 3 Play audio on the external audio device (refer to the user manual of the device).



Record to a USB device

Audio CD tracks and MP3 files are recorded in .mp3 format.

The first time you record to a USB device, a folder is automatically created in the USB device. Each time you record to a USB device, the recorded files are stored in a sub-folder. Files and subfolders are named numerically in the order by which they are created.

- 1 Plug a USB device into the  socket.
- 2 Select the disc source and load a disc.
 - To record one track in a disc: select a track to play, then press **USB REC**.
 - To record all tracks in a disc: press  to stop play, then press **USB REC**.

↳ Play starts automatically from the beginning of the disc or the selected track, and the recording starts.

 - To stop recording, press .

Note

- If the USB device does not have enough memory to store the audio files, a message about a full memory is displayed.
- With MP3-CD playback, you can only record all tracks in the current folder.

Set the timer

If a timer is set, the product will be turned on automatically after a preset time.

Note

- Make sure that clock is set correctly.

- 1 In standby mode, press and hold **TIMER** for two seconds.
↳ **[TIMER SET]** is displayed, then a prompt to select the sound source is displayed.
- 2 Press **▲ / ▼** repeatedly to select a sound source: DISC, USB, FM, or AM.
- 3 Press **TIMER** to confirm.
↳ **[12H]** or **[24H]** is displayed.
- 4 Press **▲ / ▼** to select 12 hour or 24 hour format.
- 5 Press **TIMER** to confirm.
↳ In 12 hour format, **[AM]** or **[PM]** is displayed. Repeat steps 4 to 5 to select AM or PM. Then the hour digits begin to flash.
↳ In 24 hour format, the hour digits begin to flash.
- 6 Repeat steps 4 to 5 to set the hour, minute, and the volume of the sound source.
↳ If the product is in standby or Eco power standby mode, the selected sound source will be activated when the preset time comes.

Note

- To cancel timer setting, press **■**.
- During timer setting, if no action is taken within 90 seconds, the product exits timer setting mode automatically.

Activate or deactivate the timer

- In standby mode, press **TIMER** repeatedly to activate or deactivate the timer.
↳ If the alarm timer is activated, **[TIMER ON]** is displayed.
↳ If the alarm timer is deactivated, **[TIMER OFF]** is displayed.

Set sleep timer

When the product is turned on, press **SLEEP** repeatedly to select a period of time (in minutes).

- ↳ The product switches to standby mode automatically after the preset time period.
- ↳ When **[SLEEP OFF]** (sleep off) is displayed, the sleep timer is deactivated.

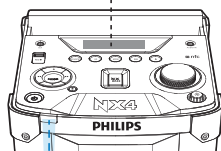
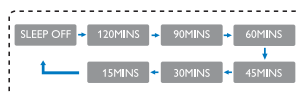

Turn decorative light on or off

In power-on mode, press **LIGHT** repeatedly to select a speaker light color or turn the light off:

- [PEACE]
- [POWERFUL]
- [PASSION]
- [SAMBA]
- [FIESTA]
- [CIELO]
- [CUSTOM]
- [OFF]

Listen through a headphone

Plug a headphone into the  socket on the product.

9 Product information

Note

- Product information is subject to change without prior notice.

Specifications

Amplifier

Total Output Power	1000W RMS (THD 30%)
Frequency Response	60 -20000 Hz, ± 3 dB
Signal to Noise Ratio	≥ 70 dBA
Audio/AUX Input	1V/2V RMS Rin $\geq 22k\Omega$

Disc

Laser Type	Semiconductor
Disc Diameter	12cm/8cm
Support Disc	CD-DA, CD-R, CD-RW, MP3-CD
Audio DAC	24 Bits / 44.1 kHz
Total Harmonic Distortion	$< 1\%$ (1 kHz)
Frequency Response	60 Hz - 20 kHz (44.1 kHz)
S/N Ratio	≥ 70 dBA

Speakers

Speaker	3 ohm
Impedance	
Speaker Driver	6.5" Woofer; 2" Tweeter
Sensitivity	Woofer: 87 ± 3 dB/m/W; Tweeter: 88 ± 3 dB/m/W

Tuner

Tuning Range	FM: 87.5 - 108MHz; AM: 531 - 1602kHz (9KHz); 530 - 1700KHz (10KHz)
Tuning Grid	100kHz (FM), 9KHz/10KHz (AM)
-Mono, 26dB S/N Ratio	< 22 dBf
Search Selectivity	< 35 dBf
Total Harmonic Distortion	$< 2\%$
Signal to Noise Ratio	> 50 dB
Number of Presets	20 FM, 10 AM

Bluetooth

Bluetooth Version	V4.0 + EDR
Bluetooth Frequency Band	2.402GHz ~ 2.48GHz ISM Band
Bluetooth Profile	A2DP, AVRCP V1.4
Range	10 m (Free space)

General information

AC Power	110-127V / 220-240V~, 50/60 Hz
Operation Power Consumption	170 W
Standby Power Consumption	30 W
Eco Power Standby Consumption	< 1 W
USB Direct	Version 2.0HS, 5V 1A
Headphone Output	5.0mW 2x 16 Ω
Operating Temperature and Humidity	0°C to 45°C, 5% to 90% humidity for all climates
Dimensions - Main Unit (W x H x D)	287 x 818 x 303 mm
Weight - Main Unit	13 kg

USB playability information

Compatible USB devices:

- USB flash memory (USB 2.0)
- USB flash players (USB 2.0)
- memory cards (requires an additional card reader to work with this unit)

Supported formats:

- USB or memory file format FAT12, FAT16, FAT32 (sector size: 512 bytes)
- MP3 bit rate (data rate): 32-320 Kbps and variable bit rate
- Directory nesting up to a maximum of 8 levels
- Number of albums/ folders: maximum 99
- Number of tracks/titles: maximum 999
- ID3 tag v1.2 or later
- File name in Unicode UTF8 (maximum length: 128 bytes)

Unsupported formats:

- Empty albums: an empty album is an album that does not contain MP3 files, and is not be shown in the display.
- Unsupported file formats are skipped. For example, Word documents (.doc) or MP3 files with extension .dlf are ignored and not played.
- AAC, WAV, PCM audio files
- WMA files

Supported MP3 disc formats

- ISO9660, Joliet
- Maximum title number: 999 (depending on file name length)
- Maximum album number: 99
- Supported sampling frequencies: 32 kHz, 44.1kHz, 48 kHz
- Supported Bit-rates: 32-320 (kbps), variable bit rates
- ID3 tag v1.2 or later
- Directory nesting up to a maximum of 8 levels

Maintenance

Clean the cabinet

- Use a soft cloth slightly moistened with a mild detergent solution. Do not use a solution containing alcohol, spirits, ammonia or abrasives.

Clean discs

- When a disc becomes dirty, clean it with a cleaning cloth. Wipe the disc from the centre out.

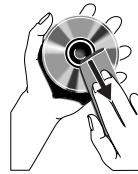

- Do not use solvents such as benzene, thinner, commercially available cleaners, or antistatic spray intended for analogue records.

Clean the disc lens

- After prolonged use, dirt or dust may accumulate at the disc lens. To ensure good play quality, clean the disc lens with Philips CD lens cleaner or any commercially available cleaner. Follow the instructions supplied with cleaner.

10 Troubleshooting



Caution

- Never remove the casing of this unit.

To keep the warranty valid, never try to repair the system yourself.

If you encounter problems when using this unit, check the following points before requesting service. If the problem remains unsolved, go to the Philips web site (www.philips.com/support). When you contact Philips, ensure that your unit is nearby and the model number and serial number are available.

No power

- Make sure that the AC power plug of the unit is connected properly.
- Make sure that there is power at the AC outlet.
- To save power, the unit switches to standby automatically 10 minutes after a play reaches the end and no control is operated.

No sound or poor sound

- Adjust the volume.
- Check if the product is muted. If yes, press  to resume sound.

No response from the unit

- Disconnect and reconnect the AC power plug, then turn on the unit again.

Remote control does not work

- Before you press any function button, first select the correct source with the remote control instead of the main unit.
- Reduce the distance between the remote control and the unit.
- Insert the batteries with their polarities (+/- signs) aligned as indicated.
- Replace the batteries.
- Aim the remote control directly at the sensor on the front of the main unit.

No disc detected

- Insert a disc.
- Check if the disc is inserted upside down.

- Wait until the moisture condensation at the lens has cleared.
- Replace or clean the disc.
- Use a finalized CD or correct format disc.

Cannot display some files in USB device

- The number of folders or files in the USB device has exceeded a certain limit. This phenomenon is not a malfunction.
- The formats of these files are not supported.

USB device not supported

- The USB device is incompatible with the unit. Try another one.

Poor radio reception

- Increase the distance between the unit and other electrical appliances.
- Adjust the position of the antenna for better reception.

About Bluetooth device

The audio quality is poor after connection with a Bluetooth-enabled device.

- The Bluetooth reception is poor. Move the device closer to this product or remove any obstacle between them.

Cannot connect with the device.

- The Bluetooth function of the device is not enabled. Refer to the user manual of the device for how to enable the function.
- This product is already connected with another Bluetooth-enabled device. Disconnect that device and then try again.

The paired device connects and disconnects constantly.

- The Bluetooth reception is poor. Move the device closer to this product or remove any obstacle between them.
- For some devices, Bluetooth connection may be deactivated automatically as a power-saving feature. This does not indicate any malfunction of this product.

11 Notice

Any changes or modifications made to this device that are not expressly approved by Gibson Innovations may void the user's authority to operate the equipment.

Care of the environment

Disposal of your old product



Your product is designed and manufactured with high quality materials and components, which can be recycled and reused.

Do not throw away the product with the normal household waste at the end of its life, but hand it in at an official collection point or recycling. By doing this, you help to preserve the environment.

Environmental information

All unnecessary packaging has been omitted. We have tried to make the packaging easy to separate into three materials: cardboard (box), polystyrene foam (buffer) and polyethylene (bags, protective foam sheet.)

Your system consists of materials which can be recycled and reused if disassembled by a specialized company. Please observe the local regulations regarding the disposal of packaging materials, exhausted batteries and old equipment.

Trademark notice

Bluetooth

The Bluetooth® word mark and logos are registered trademarks owned by Bluetooth SIG, Inc. and any use of such marks by Gibson Innovations Limited is under license. Other trademarks and trade names are those of their respective owners.



The N Mark is a trademark or registered trademark of NFC Forum, Inc. in the United States and in other countries.



This is CLASS II apparatus with double insulation, and no protective earth provided.



**Be responsible
Respect copyrights**

The making of unauthorized copies of copy-protected material, including computer programs, files, broadcasts and sound recordings, may be an infringement of copyrights and constitute a criminal offence. This equipment should not be used for such purposes.

Specifications are subject to change without notice. Gibson reserves the right to change products at any time without being obliged to adjust earlier supplies accordingly.



Specifications are subject to change without notice.

2016 © Gibson Innovations Limited. All rights reserved.

This product has been manufactured by, and is sold under the responsibility of Gibson Innovations Ltd., and Gibson Innovations Ltd. is the warrantor in relation to this product.

Philips and the Philips Shield Emblem are registered trademarks of Koninklijke Philips N.V. and are used under license from Koninklijke Philips N.V.

NTX401x_77_UM_V1.0

