

Always there to help you

Register your product and get support at
www.philips.com/welcome

FWT3600



User manual

PHILIPS

Contents

1 Important	2
Safety	2
Notice	3

2 Your Mini Hi-Fi System	4
Introduction	4
What's in the box	4
Overview of the main unit	5
Overview of the remote control	6

3 Get started	8
Connect speakers	8
Connect FM antenna	8
Connect AM antenna	8
Connect power	9
Prepare the remote control	9
Auto install radio stations	10
Set clock	10
Turn on	10

4 Play from a disc or USB	11
Play disc	11
Play from USB	11
Play options	12

5 Play audio through Bluetooth	13
---------------------------------------	-----------

6 Listen to an external device	15
Listen to an MP3 player	15
Listen to a PC	15

7 Listen to radio	16
Tune to a radio station	16
Program radio stations manually	16
Program radio stations automatically	16
Select a preset radio station	16
Change AM tuning grid	16

8 Adjust volume level and sound effect	17
Adjust volume level	17
Mute sound	17
Boost loudness	17
Select a preset sound effect	17
Enhance bass	17
Virtual surround	17
Customize sound for room acoustics	17

9 USB record	18
Record to USB	18
Schedule radio-to-USB record	18
Record CDDA contents to USB at any playback time	19

10 Other features	20
Set the alarm timer	20
Set the sleep timer	20
Karaoke	20

11 Product information	21
Specifications	21
USB playability information	21
Supported MP3 disc formats	22
Maintenance	22

12 Troubleshooting	23
---------------------------	-----------

1 Important

Safety



This 'bolt of lightning' indicates uninsulated material within your unit may cause an electrical shock. For the safety of everyone in your household, please do not remove product covering.

The 'exclamation point' calls attention to features for which you should read the enclosed literature closely to prevent operating and maintenance problems.

WARNING: To reduce the risk of fire or electric shock, this apparatus should not be exposed to rain or moisture and objects filled with liquids, such as vases, should not be placed on this apparatus.

CAUTION: To prevent electric shock, match wide blade of plug to wide slot, fully insert.

Important Safety Instructions

- ① Read these instructions.
 - ② Keep these instructions.
 - ③ Heed all warnings.
 - ④ Follow all instructions.
 - ⑤ Do not use this apparatus near water.
 - ⑥ Clean only with dry cloth.
 - ⑦ Install in accordance with the manufacturer's instructions.
 - ⑧ Do not install near any heat sources such as radiators, heat registers, stoves, or other apparatus (including amplifiers) that produce heat.
 - ⑨ Protect the power cord from being walked on or pinched, particularly at plugs, convenience receptacles, and the point where they exit from the apparatus.
 - ⑩ Only use attachments/accessories specified by the manufacturer.
 - ⑪ Use only with the cart, stand, tripod, bracket, or table specified by the manufacturer or sold with the apparatus. When a cart is used, use caution when moving the cart/apparatus combination to avoid injury from tip-over.
- 
- A circular warning icon with a diagonal slash through it. It depicts a person tripping over a power cord that is plugged into a wall outlet.
- ⑫ Unplug this apparatus during lightning storms or when unused for long periods of time.
 - ⑬ Refer all servicing to qualified service personnel. Servicing is required when the apparatus has been damaged in any way, such as power-supply cord or plug is damaged, liquid has been spilled or objects have fallen into the apparatus, the apparatus has been exposed to rain or moisture, does not operate normally, or has been dropped.
 - ⑭ **Battery usage CAUTION** – To prevent battery leakage which may result in bodily injury, property damage, or damage to the unit:
 - Install all batteries correctly, + and - as marked on the unit.
 - Do not mix batteries (old and new or carbon and alkaline, etc.).
 - Remove batteries when the unit is not used for a long time.

- Batteries (battery pack or batteries installed) shall not be exposed to excessive heat such as sunshine, fire or the like.

- 15 Apparatus shall not be exposed to dripping or splashing.
- 16 Do not place any sources of danger on the apparatus (e.g. liquid filled objects, lighted candles).
- 17 Where the MAINS plug or an appliance coupler is used as the disconnect device, the disconnect device shall remain readily operable.

 **Warning**

- Never remove the casing of this apparatus.
- Never lubricate any part of this apparatus.
- Never place this apparatus on other electrical equipment.
- Keep this apparatus away from direct sunlight, naked flames or heat.
- Never look into the laser beam inside this apparatus.
- Ensure that you always have easy access to the power cord, plug or adaptor to disconnect this apparatus from the power.

 **Caution**

- Use of controls or adjustments or performance of procedures other than herein may result in hazardous radiation exposure or other unsafe operation.

Notice

Any changes or modifications made to this device that are not expressly approved by Philips Consumer Lifestyle may void the user's authority to operate the equipment.

 **Be responsible
Respect copyrights**

The making of unauthorized copies of copy-protected material, including computer

programs, files, broadcasts and sound recordings, may be an infringement of copyrights and constitute a criminal offence. This equipment should not be used for such purposes.

Environmental information

All unnecessary packaging has been omitted. We have tried to make the packaging easy to separate into three materials: cardboard (box), polystyrene foam (buffer) and polyethylene (bags, protective foam sheet.) Your system consists of materials which can be recycled and reused if disassembled by a specialized company. Please observe the local regulations regarding the disposal of packaging materials, exhausted batteries and old equipment.

This apparatus includes this label:



 **Note**

- The type plate is located on the back of the unit.

2 Your Mini Hi-Fi System

Congratulations on your purchase, and welcome to Philips! To fully benefit from the support that Philips offers, register your product at www.Philips.com/welcome.

Introduction

With this unit, you can enjoy audio from discs, USB devices, Bluetooth devices or external devices. You can also listen to radio stations through it.

To enrich sound, this unit offers you these sound effects:

- MAX sound for instant power boost
- Digital Sound Control (DSC)
- Dynamic Bass Boost (DBB)
- Incredible surround (IS)
- Virtual Ambience-based Control (VAC)

The unit supports the following media formats:



What's in the box

Check and identify the contents of your package:

- Main unit x 1
- Loudspeaker box x 2
- Remote control x 1 (with 2 AAA batteries)
- FM wire antenna x 1
- AM loop antenna x 1
- MP3 link cable x 1
- Printing materials

Overview of the main unit

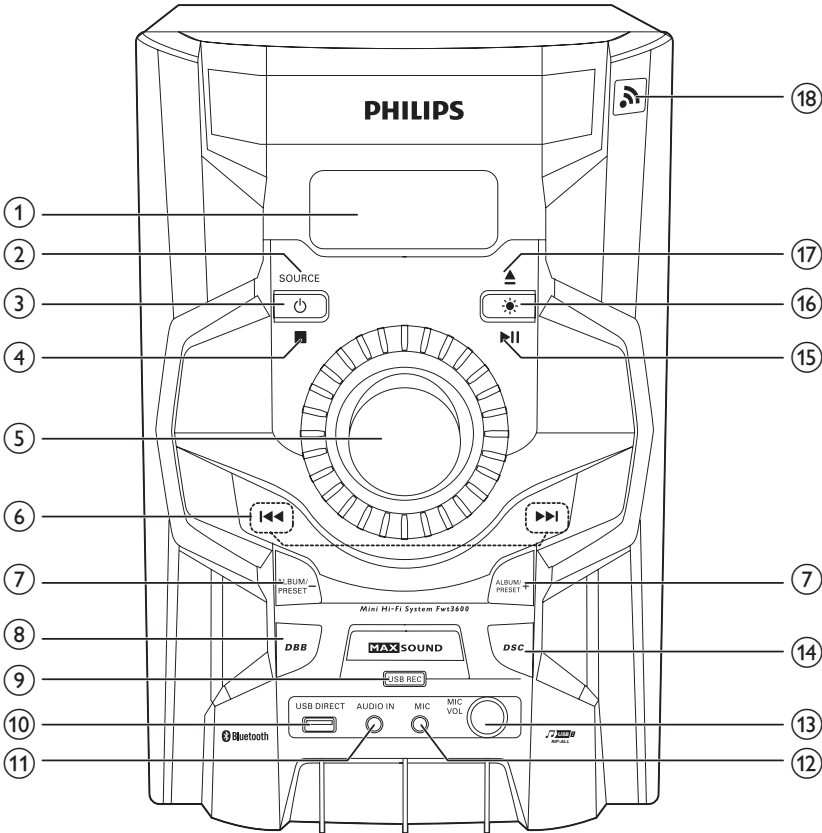

① Display panel

- Show current status.

② SOURCE

- Select a source.

③

- Turn on the unit or switch to standby mode.

④

- In Disc/USB mode, stop playing.
- In Disc/USB mode, erase programs.
- Exit the process of recording, setting clock and timer, or auto installing radio stations.

⑤ Volume dial

- Rotate clockwise to increase volume; rotate counterclockwise to decrease volume.

⑥ /

- In Disc/USB/Bluetooth mode, skip to the previous/next track.
- In Disc/USB mode, search within a track.
- Tune to a radio station.

⑦ ALBUM/PRESET +/-

- Skip to the previous/next album.
- Select a preset radio station.

- ⑧ **DBB**
 - Turn on or off dynamic bass enhancement (DBB).
- ⑨ **USB REC**
 - Record to a USB device.
- ⑩ **USB DIRECT**
 - Jack for the external USB mass storage device.
- ⑪ **AUDIO IN**
 - Audio input jack (3.5mm) for an external audio device.
- ⑫ **MIC**
 - Jack for a microphone.
- ⑬ **MICVOL**
 - Adjust microphone volume.
- ⑭ **DSC**
 - Select a preset sound equalizer setting.
- ⑮ **▶||**
 - Start or pause play.
- ⑯ **☀**
 - When playing from a disc/USB, turn on or off the backlight on the front cabinet of the main unit.
- ⑰ **▲**
 - Open or close the disc compartment.
- ⑱ **Bluetooth indicator**

Overview of the remote control

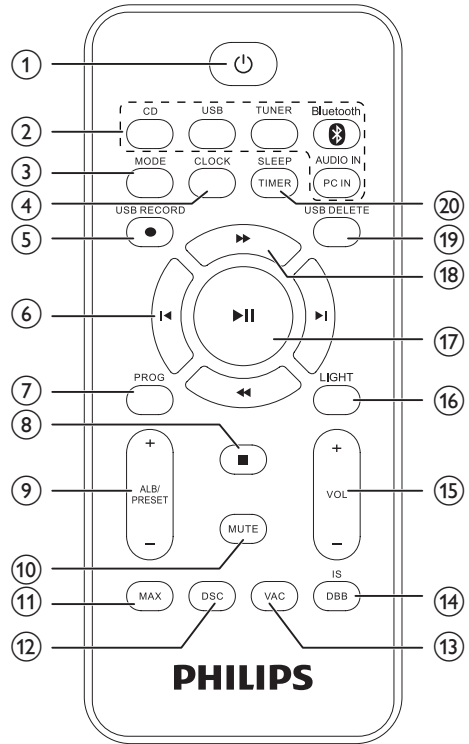

- ① **⏻**
 - Turn on the unit or switch to standby mode.
- ② **Source selection keys**
 - Select a source.
- ③ **MODE**
 - In Disc/USB mode, select repeat play or random play.
- ④ **CLOCK**
 - Set the clock.
 - View the clock during play.
- ⑤ **USB RECORD**
 - Record to a USB device.

⑥ **⏮ / ⏭**

- In Disc/USB/Bluetooth mode, skip to the previous/next track.
- When setting clock, select hour format and adjust hour and minute.
- When setting alarm, adjust alarm clock and sound source.

⑦ **PROG**

- Program tracks.
- Program radio stations.

⑧ **■**

- In Disc/USB mode, stop playing.
- In Disc/USB mode, erase programs.
- Exit the process of recording, setting clock and timer; or auto installing radio stations.

⑨ **ALB/PRESET+/-**

- Skip to the previous/next album.
- Select a preset radio station.

⑩ **MUTE**

- Mute volume.

⑪ **MAX**

- Turn on or off instant power boost for sound.

⑫ **DSC**

- Select a preset sound equalizer.

⑬ **VAC**

- Select an ambience -based equalizer setting.

⑭ **DBB/IS**

- Turn on or off dynamic bass enhancement.
- Turn on or off incredible surround.

⑮ **VOL +/-**

- Adjust volume.

⑯ **LIGHT**

- When playing from a disc/USB, turn on or off the backlight on the front cabinet of the main unit.

⑰ **▶ ||**

- Start or pause play.

⑱ **◀◀ / ▶▶**

- Adjust radio frequency.
- When playing from disc/USB, search within a track.

⑲ **USB DELETE**

- Delete audio files stored on a USB storage device.

⑳ **SLEEP/TIMER**

- Set the sleep timer.
- Set the alarm timer.
- Turn on or off sleep/alarm timer.

3 Get started

! Caution

- Use of controls or adjustments or performance of procedures other than herein may result in hazardous radiation exposure or other unsafe operation.

Always follow the instructions in this chapter in sequence.

If you contact Philips, you will be asked for the model and serial number of this apparatus. The model number and serial number are on the back of the apparatus. Write the numbers here:

Model No. _____

Serial No. _____

Connect speakers

≡ Note

- For optimal sound, use the supplied speakers only.
- Connect only speakers with impedance that is the same or higher than the supplied speakers. Refer to the Specifications section of this manual.

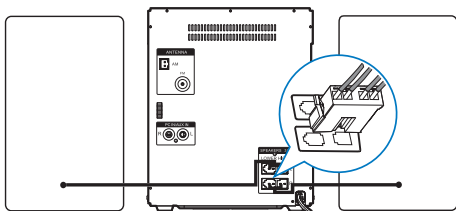

≡ Note

- Make sure that the colors of the speaker wires and terminals are matched.

Insert the wire completely.

- Insert the right speaker wires to "R", and left speaker wires to "L".

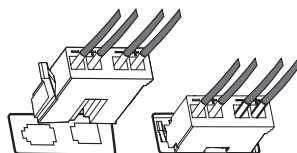

Connect FM antenna

Connect the supplied FM antenna to the **FM** jack on the back of the main unit.

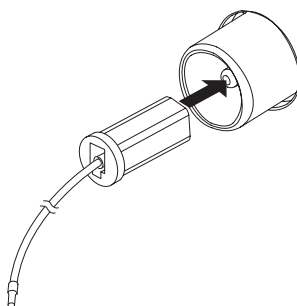

Connect AM antenna

1 Assemble the AM loop antenna.

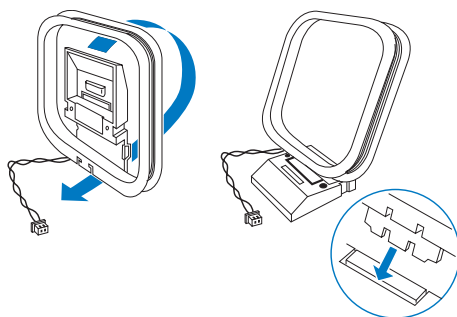

- 2 Connect the AM loop antenna to the AM jack on the back of the main unit. Adjust the position of the antenna for optimal reception.

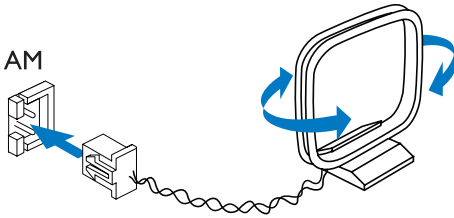

Connect power

- 1 Connect the AC power plug to the power outlet.

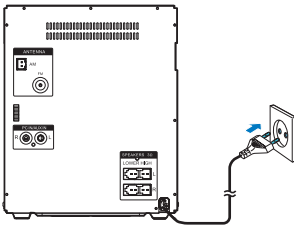

! Caution

- Risk of product damage! Make sure that the power supply voltage corresponds to the voltage set on the voltage selector on the bottom of the unit.
- Before connecting to the AC power, make sure that you have completed all other connections.

Prepare the remote control

≡ Note

- Risk of explosion! Keep batteries away from heat, sunshine or fire. Never discard batteries in fire.
- Danger of explosion if battery is incorrectly replaced. Replace only with the same or equivalent type.

To replace the remote control battery:

- 1 Open the battery compartment.
- 2 Insert two AAA batteries with correct polarity (+/-) as indicated.
- 3 Close the battery compartment.

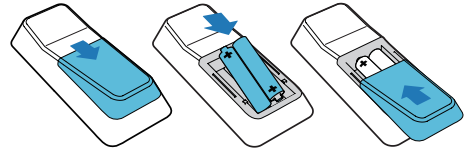

≡ Note

- If you are not going to use the remote control for a long time, remove the batteries.
- Do not use old and new or different types of batteries in combination.
- Batteries contain chemical substances, so they should be disposed of properly.

Auto install radio stations

When you connect power and no radio stations are stored, the unit automatically begins to store radio stations.

- 1 Connect the unit to the power supply.
 - ↳ [AUTO INSTALL - PRESS PLAY KEY] (auto install - press PLAY key) is displayed.
- 2 Press ►|| to start installation.
 - ↳ [AUTO] (auto) is displayed.
 - ↳ The unit automatically stores radio stations with sufficient signal strength.
 - ↳ When all the available radio stations are stored, the first preset radio station broadcasts automatically.



Tip

- Press ■ to exit the auto install process without saving any radio station.

Turn on

Press ⏻.

- ↳ The unit switches to the last selected source.

Switch to standby

Press ⏻ to switch the unit to standby mode.

- ↳ The backlight on the display panel turns off.
- ↳ The clock (if set) appears on the display panel.

Set clock

- 1 In standby mode, press and hold **CLOCK** to activate clock setting mode.
 - ↳ The screen displays scrolling text [SET TIME], then [12H] or [24H] begins to blink.
- 2 Press ◀/▶ repeatedly to select 12 hour or 24 hour format.
- 3 Press **CLOCK** to confirm.
 - ↳ The clock digits are displayed, and the hour digits begin to blink.
- 4 Repeat steps 2-3 to set the hour and minute.



Tip

- To view the clock during play, press **CLOCK**.

4 Play from a disc or USB

Play disc

- 1 Press **CD** to select the disc source.
- 2 Press **▲** on the main unit to open the disc compartment.
- 3 Load a disc on the disc tray, with the printed side facing up.
- 4 Press **▲** on the main unit to close the disc compartment.
 - ↳ Play starts automatically.
 - To pause/resume play, press **▶||**.
 - To stop play, press **■**.
 - To select another track, press **◀|▶**.
 - To select an album, press **ALB/PRESET+/-**.
 - To search within a track, press and hold **◀◀/▶▶**, then release to resume normal play.

Play from USB

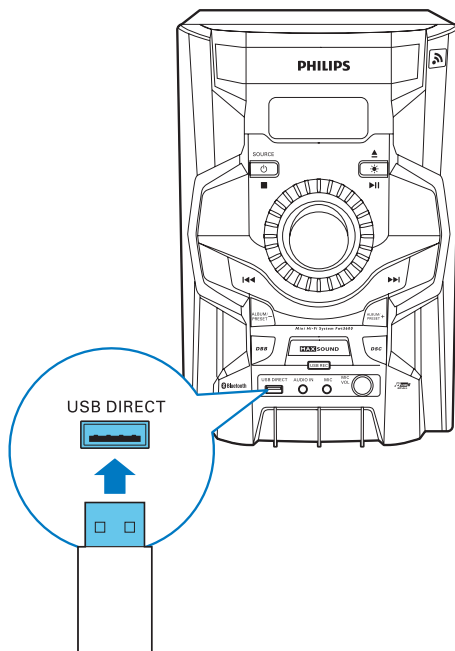

Note

- Ensure that the USB device contains playable audio contents for supported formats.

- 1 Plug the USB device into the **USB DIRECT** socket of this unit.
- 2 Press **USB** to select the USB source.
- 3 Press **ALB/PRESET+/-** to select a folder.
- 4 Press **◀|▶** to select an audio file.
- 5 If the USB device doesn't play, press **▶||**.
 - To pause/resume play, press **▶||**.
 - To stop play, press **■**.
 - To search within an audio file, press and hold **◀◀/▶▶**, then release to resume normal play.



Delete a track

You can delete a track from the USB during playback.

- 1 During play, press **USB DELETE**.
 - ↳ The screen displays scrolling text: [DELETE TRACK - PRESS AGAIN TO DELETE] (delete track - press again to delete)
- 2 Press **USB DELETE** to confirm deletion.

Play options

Repeat and random play

- 1 When playing from a CD or USB, press **MODE** repeatedly to select:
 -  : the current track is played repeatedly.
 -  : all tracks are played repeatedly.
 -  : all tracks are played randomly.
- 2 To return to normal play, press **MODE** repeatedly until play mode is no longer displayed.



Tip

- Shuffle play cannot be selected when you play programmed tracks.

Program tracks

You can program a maximum of 40 tracks.

- 1 In Disc/USB mode, press **■** to pause playing.
- 2 Press **PROG** to activate program mode.
 - ↳ A position number and [PROG] (program) flash on the screen.
- 3 For MP3 tracks, press **ALB/PRESET +/-** to select an album.

- 4 Press **◀/▶** to select a track number, then press **PROG** to confirm.
- 5 Repeat steps 2 to 4 to select and store all tracks to program.
- 6 Press **PROG** repeatedly to find a program, and press **▶||** to play the programmed track.
 - ↳ During play, [PROG] (program) is displayed.
 - To erase the program, press **■** for two times.

5 Play audio through Bluetooth

The unit uses Bluetooth wireless technology to stream music from your Bluetooth device to the system.

Note

- Before you connect a Bluetooth device to this unit, familiarize yourself with the Bluetooth capabilities of the device.
- The effective operation range between the docking system and the paired phone is approximately 10 meters (30 feet).
- Any obstacle between the unit and the phone can reduce the operational range.
- Keep this unit away from other electronic devices that may cause interference.

- 1 Press **Bluetooth** to turn on Bluetooth function of the unit.
↳ The Bluetooth indicator blinks.
- 2 On your Bluetooth, go to **[Settings]** (Settings) > **[Wireless and networks]** (Wireless and networks) > **[Bluetooth settings]** (Bluetooth settings).
- 3 Tap **[Bluetooth]** (Bluetooth) to turn on Bluetooth function of your device.
- 4 Tap **[Search for devices]** (Search for devices).
↳ A Bluetooth pairing request appears.

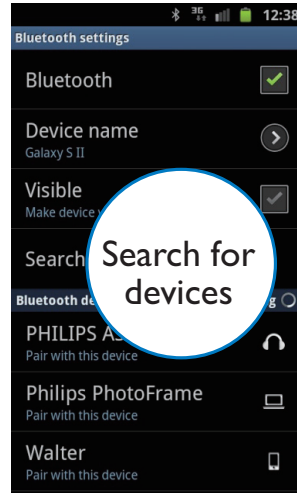

- 5 Tap **[Accept]** (Accept) to start pairing your device with the unit.

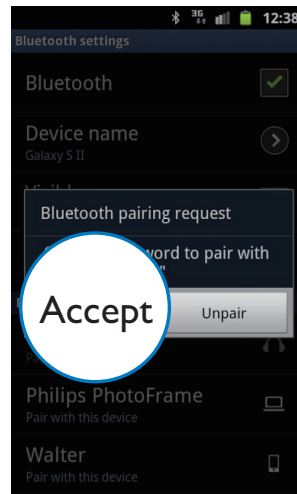

- ↳ **[PHILIPS FWT3600]** (Philips FWT3600) is displayed.
- ↳ If connected successfully, a different Bluetooth icon can be found on the top of the screen.

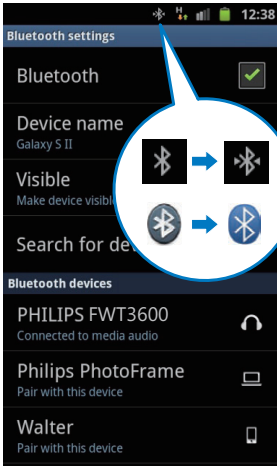

↳ After Bluetooth connection, you can enjoy audio on your phone through the unit.

Tip

- Different devices may have different way to enable Bluetooth function.

6 Listen to an external device

You can listen to an external audio device through the speakers of this unit.

Listen to an MP3 player

- 1 Press **AUDIO IN** to select the MP3 link source.
- 2 Connect the supplied MP3 link cable to:
 - the **AUDIO IN** jack (3.5mm) on the unit.
 - the headphone jack on the MP3 player.
- 3 Start to play the device (refer to the device user manual).

Listen to a PC

You can connect a PC or other audio devices.

- 1 Press **PC IN** repeatedly to select the [PC IN] source.
- 2 Connect the audio cables (white/red, not supplied) to:
 - the **PC IN** jack (white/red) on the back of the unit.
 - the headphone jack on the PC, or **AUDIO OUT** jacks on an external device.
- 3 Start to play the device (refer to the device user manual).

7 Listen to radio

Tune to a radio station

- 1 Press **TUNER** repeatedly to select FM or AM.
- 2 Press **◀◀/▶▶** or press and hold **◀/▶** for more than 2 seconds.
 - ↳ [SEARCH] (search) is displayed.
 - ↳ The radio tunes to a station with strong reception automatically.
- 3 Repeat step 2 to tune to more stations.
 - To tune to a weak station, press **◀/▶** repeatedly until you find optimal reception.

Program radio stations manually

You can program a maximum of 30 FM and 10 AM preset radio stations.

- 1 Tune to a radio station.
- 2 Press **PROG** to activate program mode.
 - ↳ [PROG] (program) and a position number are displayed.
- 3 Press **ALB/PRESET+/-** to allocate a number to this radio station, then press **PROG** to confirm.
- 4 Repeat the above steps to program other stations.

Tip

- To overwrite a programmed station, store another station in its place.

Program radio stations automatically

In the tuner mode, press and hold **PROG** for more than 2 seconds to activate automatic program mode.

- ↳ [AUTO] (auto) is displayed.
- ↳ The unit automatically stores radio stations with sufficient signal strength.
- ↳ After all available radio stations are stored, the first stored radio station is broadcast automatically.

Select a preset radio station

In tuner mode, press **ALB/PRESET+/-** to select a preset number:

Tip

- Position the antenna as far as possible from TV, VCR or other radiation source.
- For optimal reception, fully extend and adjust the position of the antenna.

Change AM tuning grid

In some countries, the AM radio frequency step between adjacent channels is 10 kHz (9 kHz in some areas).

- 1 Select the tuner source.
- 2 Press and hold **■** for more than 5 seconds.
 - ↳ The frequency step is changed to 9 kHz or 10 kHz.
 - ↳ All preset stations are erased and re-programmed in AM mode.

8 Adjust volume level and sound effect

Note

- MAX sound and DSC (Digital Sound Control) cannot be activated at the same time.

Adjust volume level

- 1 During play, press **VOL +/-** to increase/decrease the volume level.

Mute sound

During play, press **MUTE** to mute/unmute sound.

Boost loudness

MAX gives an instant boost to the sound power.
Press **MAX** to turn on or off the instant power boost.

Select a preset sound effect

The DSC (Digital Sound Control) enables you to enjoy special sound effects.

During play, press **DSC** repeatedly to select from the following effects:

- [JAZZ] (jazz)
- [POP] (pop)
- [JUNGLE] (jungle)
- [ROCK] (rock)
- [SAMBA] (samba)

Enhance bass

The best DBB (Dynamic Bass Enhancement) setting is generated automatically for each DSC selection. You can manually select the DBB setting that best suits your listening environment.

- During play, press **DBB** repeatedly to select:
 - DBB 1
 - DBB 2
 - DBB 3
 - DBB OFF

Virtual surround

You can enhance audio with a virtual surround sound effect.

Press and hold **IS** to turn on or off the incredible surround.

- ↳ If the incredible surround is activated,  is displayed.

Customize sound for room acoustics

During play, press **VAC** repeatedly to select a type of listening environment:

- [HALL] (hall)
- [CINEMA] (cinema)
- [CONCERT] (concert)

9 USB record

Audio CD tracks, MP3 files, radio and audio from external devices are recorded in .mp3 format.

The first time you record to USB, a folder called '_PHILIPS' is automatically created in the USB device. Each time you record to USB, the recorded files are stored in a sub-folder in the '_PHILIPS' folder. Sub-folders are named based on the source of recording (AM, FM, MP3 LINK etc); and files are named numerically in the order they are created in the sub-folder.

Record to USB

- 1 Plug the USB device into the **USB DIRECT** socket of this unit.
- 2 Prepare the source to record from.
 - Disc - Select the disc source and load a disc. You can select a track from which a recording starts.
 - Radio - Tune to a radio station.
 - AUDIO IN/PC IN - Select the MP3 LINK/PC IN source, then connect and start to play an external device.
 - Karaoke - Singing during karaoke.
- 3 Press **USB RECORD** to start recording.
 - For discs, press **USB RECORD** repeatedly to select:
 - (A) [REC ONE] (record one): the first/current track is recorded.
 - (B) [REC ALL] (record all): all tracks/the remaining tracks are recorded.
 - ↳ Disc play starts automatically from the beginning of the disc/the selected track, and the recording starts.
 - To stop recording, press ■.

Note

- If the USB device does not have enough memory to store the audio files, a message about a full memory is displayed.

Schedule radio-to-USB record

Schedule radio recordings in advance and you can listen to your favorite programs at your convenience.

Note

- A recording is activated only in standby mode.
- The maximum length of a recording is 12 hours.



- 1 Ensure that you set the clock correctly.
- 2 Plug the USB device into the **USB DIRECT** socket of this unit.
- 3 Tune to a radio station.
- 4 Press **⏻** to switch to standby mode.
- 5 Press and hold **SLEEP/TIMER** for more than 2 seconds.
 - ↳ A prompt to select the source is displayed.
- 6 Press **TUNER** repeatedly to select FM or AM.
- 7 Press **USB RECORD**.
 - ↳ The start timer digits are displayed and begin to blink.
- 8 Press **ALB/PRESET+/-** to set the hour.
- 9 Press **◀/▶** to set the minute.
- 10 Press **SLEEP/TIMER** to confirm.
 - ↳ The end timer digits are displayed and begin to blink.
- 11 Press **ALB/PRESET+/-** to set the hour.
- 12 Press **◀/▶** to set the minute.

13 Press **SLEEP/TIMER** to confirm.

- ↳  is displayed.
- ↳ At the scheduled times, the recording begins and ends automatically.
- ↳ When the recording ends, the unit switches to standby mode.

To deactivate or re-activate a record timer

In standby mode, press **SLEEP/TIMER** repeatedly.

- ↳ If the timer is activated,  is displayed.
- ↳ If the timer is deactivated,  disappears.

Record CDDA contents to USB at any playback time

When recording from a CD-Digital Audio (CDDA) disc, you can record any piece of audio clip you desire.



Note

- Make sure that the USB storage device is connected to the main unit.

To record the CDDA content into a USB storage device at any playback time:

1 Press **USB RECORD** during CDDA playback.
↳ The recording starts.

2 Press  to stop recording.



Tip

- If the USB storage device does not have enough memory to store the audio files, a message about a full memory is displayed.
- Anytime recording is not available for CD-MP3 discs.
- Anytime recording is not available for High speed recording.

10 Other features

Set the alarm timer

This music system can be used as an alarm clock. You can select disc, radio or USB as alarm source.

Note

- If you have set a record timer and an alarm timer, only the latest timer shall be activated.

- 1 Ensure that you have set the clock correctly.
- 2 Press **⏻** to switch to standby mode.
- 3 Press and hold **SLEEP/TIMER** for more than 2 seconds.
↳ A prompt to select the source is displayed.
- 4 Press **CD**, or **TUNER** or **USB** to select a source.
- 5 Press **SLEEP/TIMER** to confirm.
↳ The clock digits are displayed and begin to blink.
- 6 Press **⏪** / **⏩** to set the hour.
- 7 Press **SLEEP/TIMER** to confirm.
- 8 Repeat step 6 to 7 to set the minute.
↳ The timer is set and activated.

To deactivate or re-activate an alarm timer

- 1 In standby mode, press **SLEEP/TIMER** repeatedly.
↳ If the timer is activated, **⌚** is displayed.
↳ If the timer is deactivated, **⌚** disappears.

Tip

- Bluetooth and MP3 LINK/PC IN mode cannot be selected as the source of the alarm timer.
- If disc or USB source is selected but no audio file can be played, radio is activated automatically.

Set the sleep timer

This unit can switch to standby automatically after a set period of time.

- 1 When the unit is turned on, press **SLEEP/TIMER** repeatedly to select a set period of time (in minutes).
↳ When sleep timer is activated, **z z** is displayed.

To deactivate sleep timer

- 1 Press **SLEEP/TIMER** repeatedly until **[OFF]** (off) is displayed.
↳ When sleep timer is deactivated, **z z** disappears on the display.

Karaoke

You can connect a microphone and sing along with a music source.

- 1 Turn **MICVOL** to the minimum level.
- 2 Connect a microphone to the microphone port on the unit.
- 3 Press **CD**, or **TUNER**, or **USB**, or **PC IN/AUDIO IN** to select the source, and start play.
- 4 Sing through the microphone.
 - To adjust the volume of the source, press **VOL +/-**.
 - To adjust the volume of the microphone, turn **MICVOL**.

11 Product information



Note

- Product information is subject to change without prior notice.

Specifications

Amplifier

Total output power	650W RMS
Frequency response	60 Hz - 16kHz
Signal-to- noise ratio	>65 dBA
Aux input	1500mV/2000mV

Disc

Laser type	Semiconductor
Disc diameter	12cm/8cm
Support disc	CD-DA, CD-R, CD-RW, MP3-CD, Mixed-CD, CD-Extra
Audio DAC	24Bits / 44.1kHz
Total harmonic distortion	<1%
Frequency response	60Hz -16kHz (44.1kHz)
S/N ratio	>70dBA

Tuner

Tuning range	FM: 87.5 - 108MHz; AM: 531 - 1602kHz (9KHz); 530 - 1700kHz (10KHz)
Tuning grid	100kHz (FM); 9kHz/10kHz (AM)

Number of presets	30 FM, 10 AM
FM	75ohm wire
AM	loop antenna

Speakers

Speaker Impedance	3ohm
Woofer	2 x 6.5"
Tweeter	2 x 1.75"
Dimensions (L x H x D)	232 x 372 x 307 mm
Weight	4.31 kg each

General information

AC power	110 - 127/220 - 240V, 50/60Hz
Operation power consumption	110 W
Standby power consumption	<5W
USB direct	Version 2.0
Dimensions	220 x 320 x 352mm
Main Unit (W x H x D)	352mm
Weight (without speakers)	3.5 kg

USB playability information

Compatible USB devices:

- USB flash memory (USB 2.0)
- USB flash players (USB 2.0)
- memory cards (requires an additional card reader to work with this unit)

Supported formats:

- USB or memory file format FAT12, FAT16, FAT32 (sector size: 512 bytes)
- MP3 bit rate (data rate): 32-320 Kbps and variable bit rate
- Directory nesting up to a maximum of 8 levels

- Number of albums/ folders: maximum 99
- Number of tracks/titles: maximum 999
- ID3 tag v1.2 or later
- File name in Unicode UTF8 (maximum length: 128 bytes)

Unsupported formats:

- Empty albums: an empty album is an album that does not contain MP3/WMA files, and is not be shown in the display.
- Unsupported file formats are skipped. For example, Word documents (.doc) or MP3 files with extension .dlf are ignored and not played.
- AAC, WAV, PCM audio files
- DRM protected WMA files (.wav, .m4a, .m4p, .mp4, .aac)
- WMA files in Lossless format

Supported MP3 disc formats

- ISO9660, Joliet
- Maximum title number: 999 (depending on file name length)
- Maximum album number: 99
- Supported sampling frequencies: 32 kHz, 44.1kHz, 48 kHz
- Supported Bit-rates: 32-320 (kbps), variable bit rates
- ID3 tag v1.2 or later
- Directory nesting up to a maximum of 8 levels

Maintenance

Clean the cabinet

- Use a soft cloth slightly moistened with a mild detergent solution. Do not use a solution containing alcohol, spirits, ammonia or abrasives.

Clean discs

- When a disc becomes dirty, clean it with a cleaning cloth. Wipe the disc from the centre out.

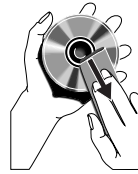

- Do not use solvents such as benzene, thinner, commercially available cleaners, or antistatic spray intended for analogue records.

Clean the disc lens

- After prolonged use, dirt or dust may accumulate at the disc lens. To ensure good play quality, clean the disc lens with Philips CD lens cleaner or any commercially available cleaner. Follow the instructions supplied with cleaner.

12 Troubleshooting

Caution

- Never remove the casing of this unit.

To keep the warranty valid, never try to repair the system yourself.

If you encounter problems when using this unit, check the following points before requesting service. If the problem remains unsolved, go to the Philips web site (www.philips.com/support). When you contact Philips, ensure that your unit is nearby and the model number and serial number are available.

No power

- Ensure that the AC power plug of the unit is connected properly.
- Ensure that there is power at the AC outlet.
- To save power, the unit switches to standby automatically 15 minutes after a play reaches the end and no control is operated.

No sound or poor sound

- Adjust the volume.
- Check that the speakers are connected correctly.
- Check if the stripped speaker wires are clamped.

Left and right sound outputs reversed

- Check the speaker connections and location.

No response from the unit

- Disconnect and reconnect the AC power plug, then turn on the unit again.

Remote control does not work

- Before you press any function button, first select the correct source with the remote control instead of the main unit.
- Reduce the distance between the remote control and the unit.

- Insert the batteries with their polarities (+/– signs) aligned as indicated.
- Replace the batteries.
- Aim the remote control directly at the sensor on the front of the main unit.

No disc detected

- Insert a disc.
- Check if the disc is inserted upside down.
- Wait until the moisture condensation at the lens has cleared.
- Replace or clean the disc.
- Use a finalized CD or correct format disc.

Cannot display some files in USB device

- The number of folders or files in the USB device has exceeded a certain limit. This phenomenon is not a malfunction.
- The formats of these files are not supported.

USB device not supported

- The USB device is incompatible with the unit. Try another one.

Poor radio reception

- Increase the distance between the unit and your TV or VCR.
- If the signal is too weak, adjust the antenna or connect an external antenna for better reception.

Clock/timer setting erased

- Power has been interrupted or the power cord has been disconnected.
- Reset the clock/timer.

Timer does not work

- Set the clock correctly.
- Switch on the timer.



Specifications are subject to change without notice
© 2013 Koninklijke Philips Electronics N.V.
All rights reserved.

FWT3600_x77_UM_V1.0

