

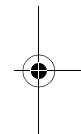

Register your product and get support at
www.philips.com/welcome

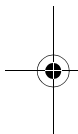

ID555



EN Telephone Answering Machine



Warning

Use only rechargeable batteries.
Charge the handset for 24 hours before use.



PHILIPS

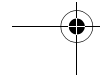
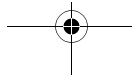

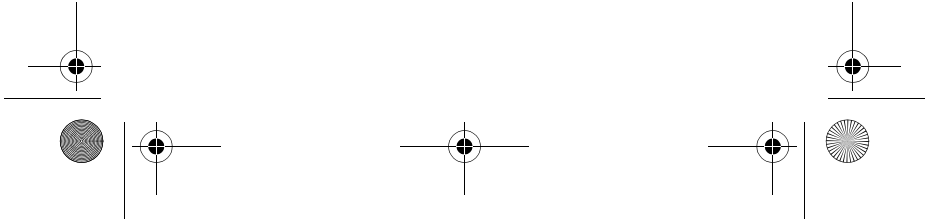
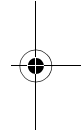
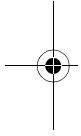
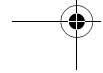
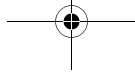
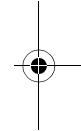
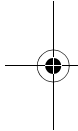



Table of contents



1	Safety information	3	4.3	Menu structure	17
1.1	Equipment Approval Information	3	5	Using your phone	20
1.2	Interference Information	4	5.1	Make a call	20
1.3	Hearing Aid Compatibility (HAC)	5	5.2	Answer a call	21
1.4	FCC RF Radiation Exposure Statement	5	5.3	End a call	21
2	Important	7	6	Use more of your phone	22
2.1	Power requirements	7	6.1	Switch the handset on/off	22
2.2	Safety Information	8	6.2	Keypad lock/unlock	22
2.3	Conformity	8	6.3	Text or number entry	22
2.4	Electric, Magnetic and Electromagnetic Fields ("EMF")	8	6.4	Call in progress	22
2.5	Recycle your batteries	9	6.5	Call waiting	23
2.6	Service Centers	9	6.6	Caller Line Identification	23
3	Your phone	10	6.7	Using your Phonebook	24
3.1	What's in the box	10	6.8	Using the Redial list	26
3.2	Overview of your phone	11	6.9	Using the Call log	27
3.3	Display icons	13	6.10	Using the Intercom	28
3.4	Overview of the base station	14	6.11	Paging	29
4	Getting started	15	7	Personal settings	30
4.1	Connect the base station	15	7.1	Change the Handset Name	30
4.2	Install your phone	15	7.2	Handset Tones	30
			7.3	Change the Display Language	31
			7.4	Set Contrast Level	31





7.5	Activate/Deactivate Auto Hang-up	31
-----	----------------------------------	----

8	Clock and Alarm settings	32
----------	---------------------------------	-----------

8.1	Set date and time	32
8.2	Set date/time format	32
8.3	Set alarm	33
8.4	Set alarm tone	33

9	Advanced settings	34
----------	--------------------------	-----------

9.1	Easy Call	34
9.2	Activate/Deactivate Conference mode	34
9.3	Call Barring	35
9.4	Change master PIN	35
9.5	Registration	36
9.6	Unregister a handset	37
9.7	Reset Unit	37
9.8	Default settings	37
9.9	Set area code	38
9.10	Set Auto Prefix	38
9.11	Change Flash time	39
9.12	Change the Dial Mode	39
9.13	Set first ring	39

10	Telephone answering machine (TAM)	41
-----------	--	-----------

10.1	Play	41
------	------	----

10.2	Delete all messages	43
------	---------------------	----

10.3	Set the Answer mode	43
------	---------------------	----

10.4	Personalized Outgoing Message	43
------	-------------------------------	----

10.5	Switch the Answering Machine On/Off via handset	44
------	---	----

10.6	Answering Machine settings	44
------	----------------------------	----

10.7	Call Screening	46
------	----------------	----

11	Technical data	48
-----------	-----------------------	-----------

12	Frequently asked questions	49
-----------	-----------------------------------	-----------

13	Index	52
-----------	--------------	-----------

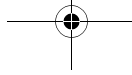
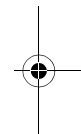
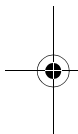



1 Safety information

1.1 Equipment Approval Information

Your telephone equipment is approved for connection to the Public Switched Telephone Network and is in compliance with parts 15 and 68, FCC Rules and Regulations and the Technical Requirements for Telephone Terminal Equipment published by ACTA.

1.1.1 Notification to the Local Telephone Company

On the bottom of this equipment is a label indicating, among other information, the US number and Ringer Equivalence Number (REN) for the equipment. You must, upon request, provide this information to your telephone company.

The REN is useful in determining the number of devices you may connect to your telephone line and still have all of these devices ring when your telephone number is called. In most (but not all) areas, the sum of the RENs of all devices connected to one line should not exceed 5. To be certain of the number of devices you may connect to your line as determined by the REN, you should contact your local telephone company.

Safety information

A plug and jack used to connect this equipment to the premises wiring and telephone network must comply with the applicable FCC Part 68 rules and requirements adopted by the ACTA.

A compliant telephone cord and modular plug is provided with this product. It is designed to be connected to a compatible modular jack that is also compliant. See installation instructions for details.

Notes

- This equipment may not be used on coin service provided by the telephone company.
- Party lines are subject to state tariffs, and therefore, you may not be able to use your own telephone equipment if you are on a party line. Check with your local telephone company.
- Notice must be given to the telephone company upon permanent disconnection of your telephone from your line.
- If your home has specially wired alarm equipment connected to the telephone line, ensure the installation of this product does not disable your alarm equipment. If you have questions about what will disable alarm equipment, consult your telephone company or a qualified installer.

US Number is located on the cabinet bottom.

REN Number is located on the cabinet bottom.

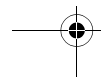
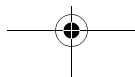
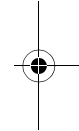
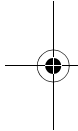



1.1.2 Rights of the Telephone Company

Should your equipment cause trouble on your line which may harm the telephone network, the telephone company shall, where practicable, notify you that temporary discontinuance of service may be required. Where prior notice is not practicable and the circumstances warrant such action, the telephone company may temporarily discontinue service immediately. In case of such temporary discontinuance, the telephone company must: (1) promptly notify you of such temporary discontinuance; (2) afford you the opportunity to correct the situation; and (3) inform you of your right to bring a complaint to the Commission pursuant to procedures set forth in Subpart E of Part 68, FCC Rules and Regulations.

The telephone company may make changes in its communications facilities, equipment, operations or procedures where such action is required in the operation of its business and not inconsistent with FCC Rules and Regulations. If these changes are expected to affect the use or performance of your telephone equipment, the telephone company must give you adequate notice, in writing, to allow you to maintain uninterrupted service.

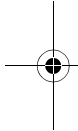

1.2 Interference Information

This equipment generates and uses radio frequency energy which may interfere with residential radio and television reception if not properly installed and used in accordance with instructions contained in this manual. Reasonable protection against such interference is ensured, although there is no guarantee this will not occur in a given installation. If interference is suspected and verified by switching this equipment on and off, the user is encouraged to try to correct the interference by one or more of the following measures: Reorient the radio/television receiver's antenna, relocate the equipment with respect to the receiver, plug the equipment and receiver into separate circuit outlets. The user may also wish to consult a qualified radio/television technician for additional suggestions. This equipment has been fully tested and complies with all limits for Class B computing devices pursuant to part 15 FCC Rules and Regulations. This device complies with RSS-210 of Industry Canada. Operation is subject to the following two conditions: (1) This device may not cause interference, and (2) This device must accept any interference, including interference that may cause undesired operation of the device. This device complies with Part 15 of the FCC Rules. Operation is subject

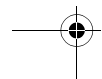
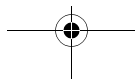
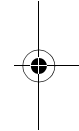



to the following two conditions:

(1) This device may not cause harmful interference; and (2) This device must accept any interference received, including interference that may cause undesired operation.

This equipment has been tested and found to comply with the limits for a Class B digital device, pursuant to Part 15 of the FCC Rules. These limits are designed to provide reasonable protection against harmful interference in a residential installation.

This equipment generates, uses, and can radiate radio frequency energy and, if not installed and used in accordance with the instructions, may cause harmful interference to radio communications. However, there is no guarantee that interference will not occur in a particular installation.

Privacy of Communications may not be ensured when using this product. If this equipment does cause harmful interference to radio or television reception, which can be determined by turning the equipment off and on, the user is encouraged to try to correct the interference by one or more of the following measures:

- Reorient or relocate the receiving antenna (that is, the antenna for radio or television that is "receiving" the interference).
- Reorient or relocate and increase the separation between the telecommunications equipment

and receiving antenna.

- Connect the telecommunications equipment into an outlet on a circuit different from that to which the receiving antenna is connected.

If these measures do not eliminate the interference, please consult your dealer or an experienced radio/television technician for additional suggestions. Also, the Federal Communications Commission has prepared a helpful booklet, "How To Identify and Resolve Radio/TV Interference Problems." This booklet is available from the U.S. Government Printing Office, Washington, D.C. 20402. Please specify stock number 004-000-00345-4 when ordering copies.

Notice: The changes or modifications not expressly approved by the party responsible for compliance could void the user's authority to operate the equipment.

1.3 Hearing Aid Compatibility (HAC)

This telephone system meets FCC/ Industry Canada standards for Hearing Aid Compatibility.

1.4 FCC RF Radiation Exposure Statement

This equipment complies with FCC RF radiation exposure limits set forth for an uncontrolled environment. This equipment should be installed

Safety information

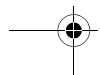
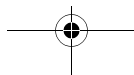



and operated with a minimum distance of 20 centimeters between the radiator and your body. This transmitter must not be co-located or operated in conjunction with any other antenna or transmitter. For body worn operation, this phone has been tested and meets the FCC RF exposure guidelines when used with the belt clip supplied with this product. Use of other accessories may not ensure compliance with FCC RF exposure guidelines.

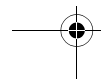
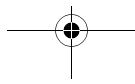
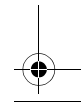
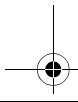
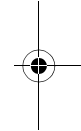
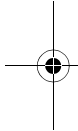



2 Important

Take time to read this user manual before you use your phone. It contains important information and notes regarding your phone.

NOTICE: This product meets the applicable Industry Canada technical specifications.

The equipment must be installed using an acceptable method of connection. The customer should be aware that compliance with the above conditions may not prevent degradation of service in some situations.

Repairs to certified equipment should be made by an authorized Canadian maintenance facility designated by the supplier. Any repairs or alterations made by the user to this equipment, or equipment malfunctions, may give the telecommunications company cause to request the user to disconnect the equipment.

Users should ensure for their own protection that the electrical ground connections of the power utility, telephone lines and internal metallic water pipe systems, if present, are connected together. This precaution may be particularly important in rural areas.

CAUTION: Users should not attempt to make such connections themselves, but should contact the

appropriate electric inspection authority, or electrician, as appropriate.

NOTES: This equipment may not be used on coin service provided by the telephone company.

2.1 Power requirements

- This product requires an electrical supply of 100-240 volts AC. In case of power failure, the communication can be lost.
- The Electrical network is classified as hazardous. The only way to power down the charger is to unplug the power supply from the electrical outlet. Ensure that the electrical outlet is always easily accessible.
- The voltage on the network is classified as TNV-3 (Telecommunication Network Voltages), as defined in the standard EN 60-950.

Warning

To avoid damage or malfunction:

- Do not allow the charging contacts or the battery to come into contact with metal objects.
- Do not open it as you could be exposed to high voltages.
- Never use any other battery than the one delivered with the product or recommended by Philips: risk of explosion.
- Always use the cables provided with the product.

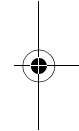
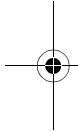

Important

7

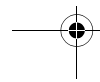
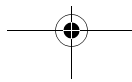



- Use only with provided batteries:
 - a) TCL, PL-043043, Li-ion polymer battery, 3.7V 500mAH
 - b) Mcnair, MC-163-500, Li-ion polymer battery, 3.7V 500mAH
- Use only with provided adaptor:

Base Station

 - a) Electronic Sales Ltd, IW507, 7.5V 500mA
 - b) Electronic Sales Ltd, TR5075G, 7.5V 500mA

Charger pod

 - a) Electronic Sales Ltd, TR1575G, 7.5V 150mA
 - b) Electronic Sales Ltd, IW157, 7.5V 150mA

- Do not use the product in places where there are explosive hazards.
- Do not let small metal objects come into contact with the product. This can deteriorate audio quality and damage the product.
- Do not allow the charger to come into contact with liquids.
- Active mobile phones in the vicinity may cause interference.

About operating and storage temperatures:

- Operate in a place where temperature is always between 0 and 35° C (32 to 95° F).
- Store in a place where temperature is always between -20 and 45° C (-4 to 113° F).
- Battery life may be shortened in low temperature conditions.

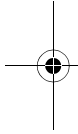

2.2 Safety Information

- Handsfree activation could suddenly increase the volume in the earpiece to a very high level: make sure the handset is not too close to your ear.
- This equipment is not designed to make emergency calls when the power fails. An alternative has to be made available to allow emergency calls.
- Do not expose the phone to excessive heat caused by heating equipment or direct sunlight.
- Do not drop your phone or allow objects to fall on your phone.
- Do not use any cleaning agents containing alcohol, ammonia, benzene, or abrasives as these may harm the set.

2.3 Conformity

We, Philips declare that the product is in compliance with the essential requirements and other relevant provisions of Directive 1999/5/EC. This product can only be connected to the analogue telephone networks of the countries mentioned on the packaging. You can find the Declaration of Conformity on www.p4c.philips.com.

2.4 Electric, Magnetic and Electromagnetic Fields ("EMF")

1. Philips Royal Electronics manufactures and sells many

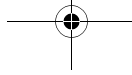
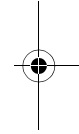

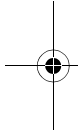

consumer oriented products which usually, as with any electronic apparatus, have the ability to emit and receive electro magnetic signals.

2. One of Philips' leading Business Principles is to take all necessary health and safety precautions for our products, to comply with all applicable legal requirements and to stay well within the EMF standards applicable at the time of producing the products.
3. Philips is committed to develop, produce and market products that cause no adverse health effects.
4. Philips confirms that if its products are handled properly for their intended use, they are safe to use according to scientific evidence available today.
5. Philips plays an active role in the development of international EMF and safety standards, enabling Philips to anticipate further developments in standardisation for early integration in its products.

2.5 Recycle your batteries

Do not dispose your rechargeable batteries. Call the toll free number 1-800-822-8837 to get instructions on how to recycle your batteries. The RBRC® Seal on the nickel metal hydride battery indicates that Philips Royal Electronics is voluntarily

Important

participating in an industry program to collect and recycle these batteries at the end of their useful lives, when taken out of service within the United States and Canada.

The RBRC® program provides a convenient alternative to placing used nickel metal hydride batteries into the trash or municipal waste, which may be illegal in your area.

Philips's participation in RBRC® makes it easy for you to drop off the spent battery at local retailers participating in the RBRC® program or at authorized Philips product service centers.

Please call 1-800-8-BATTERY for information on Ni-MH battery recycling and disposal bans/restrictions in your area. Philips's involvement in this program is part of its commitment to protecting our environment and conserving natural resources.

RBRC® is a registered trademark of Rechargeable Battery Recycling Corporation.

2.6 Service Centers

Call Center (USA and Canada):
800-233-8413
E-mail support:
accessorysupport@philips.com

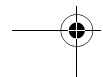
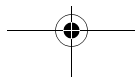
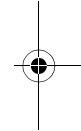

3 Your phone

Congratulations on your purchase and welcome to Philips!

To fully benefit from the support that Philips offers, register your product at www.philips.com/welcome.

3.1 What's in the box



Handset



Base station



Battery door



1 Li-ion rechargeable battery



Power supply



Line cord*



User manual



Guarantee



Quick Start Guide



Note

*You may find in the box the line adaptor delivered separately from the line cable. In this case, you have to connect the line adaptor to the line cord first before plugging the line cord to the line socket.

In multihandset packs, you will find one or more additional handsets, chargers with power supply units and additional rechargeable batteries.

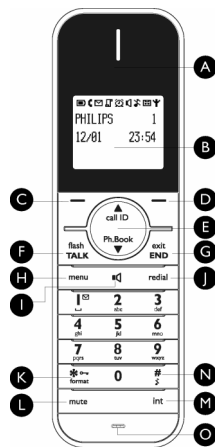
3.2 Overview of your phone





- A Earpiece**
- B Display**
See page 13 for an overview of the display icons.
- C Left Softkey** 
Select the function displayed on the handset screen directly above it.
During a call: Initiate a second call, consult phonebook or transfer a call. Switch on the backlight.
- D Right Softkey** 
Select the function displayed on the handset screen directly above it. Switch on the backlight.

- E Navigation keys** 
In idle mode: Scroll up to access the Call log and scroll down to access the Phonebook.
During a call: Scroll up/down to increase or decrease earpiece and speaker volume.
In editing mode: Scroll up/down to go to the previous character or next character.
In other modes: Scroll up/down a menu list or go to the previous or next record in the Phonebook, Redial list or Call log.

- F Talk key** 
In idle mode: Answer an incoming external or internal call.
During a call: Activate the recall function.

- G Hang-up key** 
In idle mode: Long press to switch on/off the handset.
During a call: Hang up a call.
In other modes: Return to the idle mode.

- H Menu key** 
In idle mode: Go to the main menu.
- I Loudspeaker key** 
In idle mode: Turn on the loudspeaker and dial the number.
Answer an incoming call using handsfree mode.
During a call: Toggle the loudspeaker on/off.

- J Redial key** 
In idle mode: Access the Redial list.

Your phone

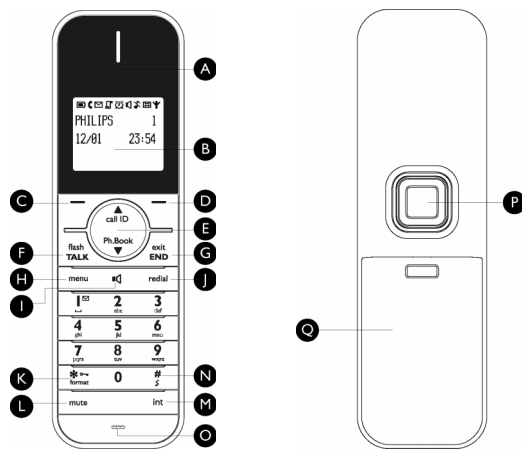

K Keypad lock/Format key 

In idle mode: Insert *. *Long press* to lock/unlock the keypad.
 During a call: Insert *.
 In call log reviewing mode: Press repeatedly to view the alternate dialing sequences.

L Mute key 

During a call: Mute/Unmute the handset microphone.

M Call transfer key & Intercom/Conference key 

In idle mode: Initiate an internal call.
 During a call: Hold the line and page another handset. *Long press* to start a conference between internal and external calls.

N Ringer on/off key & Pause key 

In idle mode: Insert #. *Long press* to turn the ringer on/off.
 During a call: Insert #.
 When predialing: *Long press* to insert a pause marked "P".
 In editing mode: *Long press* to switch between upper and lower case.

O Microphone

P Loudspeaker

Q Battery door

Danger

Handsfree activation can suddenly increase the volume in the earpiece to a very high level. Make sure the handset is not too close to your ear.



3.3 Display icons

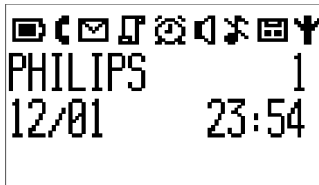

Indicates that the battery is fully charged. Icon blinks during charge and when the battery is low.



Indicates that the battery is fully discharged.



Indicates that an external call is connected or held. Icon blinks when receiving an incoming call.



Indicates new voice messages are received. Icon blinks when there are unread messages.



Displays when there are existing call log records or when call log is accessed. Icon blinks when there are new missed calls.



Displays when the alarm clock is activated.



Displays when the loudspeaker is activated.



Displays when ringer off is activated.



Indicates that the telephone answering machine is activated. Icon blinks when the memory for answering machine messages is full.



Indicates that the handset is registered and within range of the base station. Icon blinks when the handset is out of range or is searching for a base.

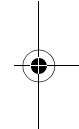
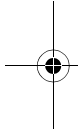

Your phone

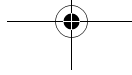

3.4 Overview of the base station

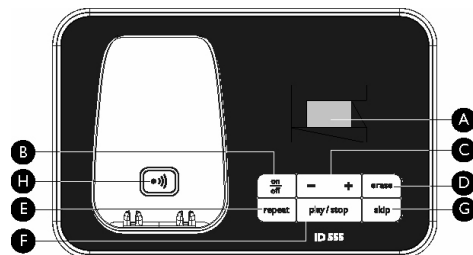

A Message Counter

Blinking: Indicates number of new messages.

Steady: Indicates number of old messages.

2 bars flashing: Indicates that there is no more memory left.

Indicates the volume level (L0 - L5) when **- +** is pressed.

Indicates the current message number during playback.

B On/Off key

In idle mode, **short press** to switch on/off the answering machine.

C Volume keys **- +**

Increase/Decrease speaker volume during message playback.

There are 5 volume levels.

The call screening is activated if the speaker volume is not set to off.

D Erase key

Delete current message during message playback.

Long press to delete all messages when the answering machine is in idle mode (unread messages will not be deleted).

E Repeat key

Go to previous message if pressed twice during message playback.

Replay current message if pressed once during message playback.

F Play/Stop key

Play phone messages (the first recorded will be played first).

Stop message playback.

G Skip key

Skip to the next message during message playback.

H Handset locator key

Page handset.
Long press to start registration procedure.



4 Getting started

4.1 Connect the base station

- 1 Place the base station in a central location near the telephone line socket and electricity socket.
- 2 Connect the line cord and the power cable to their corresponding connectors at the bottom of the base station as shown.

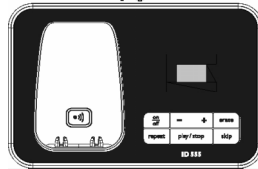
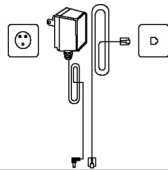

- 3 Connect the other end of the line cord to the telephone line socket and the other end of the power cable to the electricity socket.

Note

The line adaptor may not be attached to the line cord. In this case, you have to connect the line adaptor to the line cord first before plugging the line cord to the line socket.

Warning

Avoid placing the base station too close to large metal objects such as filing cabinets, radiators or electrical appliances. This can impair the range and sound quality. Buildings with thick internal and external walls may impair transmission of signals to and from the base.

Warning

The base station does not have an ON/OFF switch. Power is applied when the power adaptor is plugged into the unit and connected to the electricity socket. The only way to power down the unit is to unplug the power adaptor from the electricity socket. Therefore, ensure that the electricity socket is easily accessible. The power adaptor and telephone line cord have to be connected correctly, as incorrect connection could damage the unit.

Always use the telephone line cord supplied with the unit. Otherwise, you may not get a dial tone.

4.2 Install your phone

Before using the handset, the batteries have to be installed and fully charged.

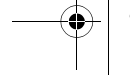
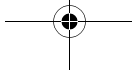



4.2.1 Install battery

Warning

Always use Li-ion rechargeable battery supplied with your unit. There could be risk of battery leakage if you use other battery types.

- 1 Slide out the battery cover.

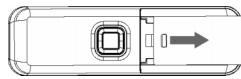

- 2 Place the battery and replace the cover.

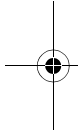
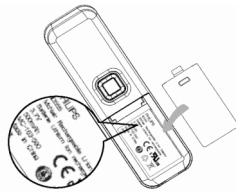

- 1 Place the handset on the charging cradle of the base station. A melody is emitted if the handset is placed correctly.
- 2 The battery icon on the display blinks during charge.
- 3 The battery icon becomes steady when the handset is fully charged.

Note

Optimal battery life is reached after 3 cycles of complete charging (over 15 hours) and discharging, allowing approximately 12 hours of talk-time and 150 hours of stand-by time.

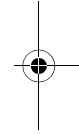

4.2.2 Charge battery

Warning



The handset must be charged for at least 24 hours before using it for the first time.

When the battery level becomes low, the low battery sensor alerts you by sounding an audible tone and blinking the battery icon.

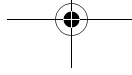
If the battery level becomes exceedingly low, the phone automatically switches off and any function in progress will not be saved.



4.3 Menu structure

The table below describes the menu tree of your phone. Press  in idle mode to enter the main menu. Use navigation keys  to navigate within the menus and press left softkey  to enter each option.

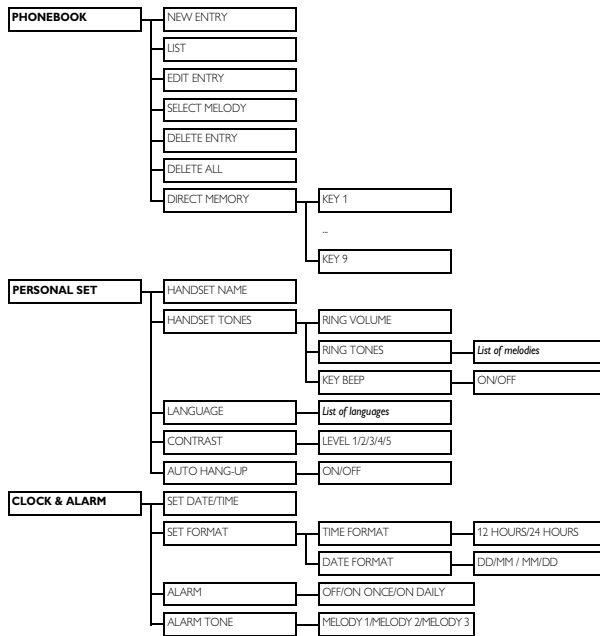

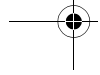
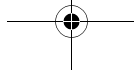
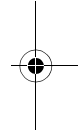
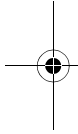
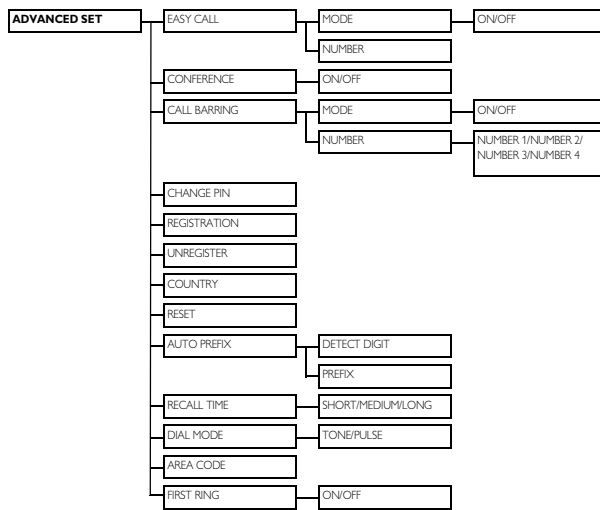

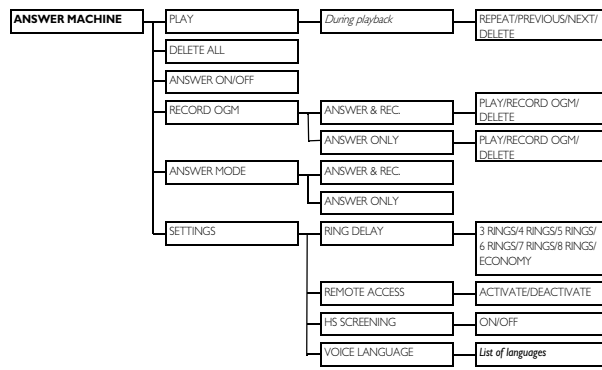

5 Using your phone

5.1 Make a call

5.1.1 Predialing

- 1 Dial the number (maximum 24 digits).
- 2 Press **TALK** or **END** key.
 - *The call is initiated.*

*** Tip**

You may insert a prefix number to the beginning of your predial number, see "Set area code" on page 38 for more information.

5.1.2 Direct dialing

- 1 Press **TALK** or **END** key to take the line.
- 2 Dial the number.
 - *The call is initiated.*

5.1.3 Call from redial list

- 1 Press **redial** key in idle mode.
- 2 Scroll **UP** to an entry in the redial list.
- 3 Press **TALK** or **END** key.
 - *The call is initiated.*

*** Tip**

The handset stores the last 20 numbers dialed. The last number dialed will appear first in the redial list. If the redial number matches a phonebook entry, the name will be displayed instead.

5.1.4 Call from the call log

- 1 Press **call log** in idle mode.
- 2 Scroll **UP** to **CALL LIST** or **ANSWER MACHINE** and press **SELECT** to enter the respective sub-menus.
- 3 Scroll **UP** to an entry.
- 4 Press **TALK** or **END** key.
 - *The call is initiated.*

Note

You need to subscribe to Caller Line Identification service to be able to see the caller's number or name in the call log (see "Access Call log" on page 27).

5.1.4.1 To choose the format for call log display

You must choose the correct format to dial the area code and number of the call log record chosen. The original incoming number from the call log will appear as a 7, 10 or 11-digit number. If it is a long distance call, the prefix digit 1 will automatically appear in front of the 10-digit local calls.

- 1 When viewing the call log, press **FORMAT** to change the format of the call log display as it should be dialed from your location. For example, if the call log entry appears as "234-567-8900":
 - Press **FORMAT** once to display "1-234-567-8900"
 - Press **FORMAT** twice to display "567-8900"
 - Press **FORMAT** 3 times to display "1-567-8900"

- Press **[*#]** 4 times to display "1-234-567-8900" again.
- 2 To dial the current displayed number, press **[*#]** key.
 - The call is initiated.

Note

You need to subscribe to Caller Line Identification service to be able to see the caller's number or name in the call log (see "Access Call log" on chapter 6.9.1).

When saving the call list entry to phonebook, the original incoming number will be saved instead of the current displayed number.

If the first 3 digits of the incoming number corresponds to the local area code set in your phone, they will be filtered automatically when you press the **[*#]** or **[*]** key to dial. To change the local area code, please refer to see "Set area code" on chapter 9.10.

5.1.5 Call from the phonebook

- 1 Press **[*#]** in idle mode.
- 2 Scroll **[↑/↓]** to a phonebook entry.
- 3 Press **[*#]** or **[*]** key.
 - The call is initiated.

*** Tip**

Instead of scrolling **[↑/↓]** to browse the phonebook entries, you can press the numeric key corresponding to the first letter of the entry you wish to locate. For example, pressing **[2]** will show the entries starting with A. Pressing **[2]** again will show the entries starting with B, etc...

5.2 Answer a call

When the phone rings, press **[*#]** key.

- The call is established.

Note

Incoming call has priority over other events. Whenever there is an incoming call, other status in progress such as phone setting, menu navigation, etc will be aborted.

Danger

When the handset rings during an incoming call, please do not hold the handset too close to your ear, as the volume of the ringing tone may damage your hearing.

5.2.1 Handsfree answering

When the phone rings, press **[*#]** key.

- The handset loudspeaker is activated.

Danger

Handsfree activation can suddenly increase the volume in the earpiece to a very high level. Make sure the handset is not too close to your ear.

5.3 End a call

To end a conversation, press **[*#]** key.

*** Tip**

If **AUTO HANG-UP** mode is activated (see "Activate/Deactivate Auto Hang-up" on page 31), you can simply place the handset back to its base station to end the call. This feature is activated by default.

Note

The call duration will be displayed on the handset screen for about 5 seconds.

6 Use more of your phone

6.1 Switch the handset on/off

Press and hold **[END]** key for 3 seconds to switch on/off the handset in idle mode.

6.2 Keypad lock/unlock

Press and hold **[*]** key for 2 seconds to lock/unlock the keypad in idle mode.

6.3 Text or number entry

When you select a field in which you can enter text, you can enter the letters that are printed on the keys by pressing the relevant key once or several times. For example, to enter the name "PAUL":

- 1 Press **[7]** once: **P**
- 2 Press **[2]** once: **PA**
- 3 Press **[8]** twice: **PAU**
- 4 Press **[5]** three times: **PAUL**

The table below gives you the character assignment during text or number entry:

Keys	Assigned characters
[1]	space 1 @ _ # = < > () & € £ \$ ¥ [] { } ¢ §
[2]	a b c 2 à ä ç â æ
[3]	d e f 3 è é Δ Φ
[4]	g h i 4 i Γ

[5]	j k l 5 Λ
[6]	m n o 6 ñ ò ö
[7]	p q r s 7 β Π Θ Σ
[8]	t u v 8 ù ü
[9]	w x y z 9 ø Ω Ξ Ψ
[0]	. 0 , / ; " ' ! ; ? ; * + - % \ ^ _
#	Long press to switch between upper and lower case.
[*]	*

* Tip

Press **[←]** **BACK** to delete the last digit or character entered.

6.4 Call in progress

Some options are available to you during a call. The available options are:

6.4.1 Adjust earpiece volume

During a call, press **[+/-]** to select from **VOLUME 1** to **VOLUME 3**.

6.4.2 Mute/Unmute microphone

When the microphone is muted, your correspondent cannot hear you.

- 1 During a call, press **[M]** to turn off the microphone.
- 2 Press **[M]** again to turn on the microphone.



6.4.3 Activate/Deactivate loudspeaker mode

Danger

Handsfree activation can suddenly increase the volume in the earpiece to a very high level. Make sure the handset is not too close to your ear.

- 1 During a call, press key to activate the loudspeaker mode.
- 2 Press key again to return to normal mode.

6.4.4 Adjust loudspeaker volume

During a call in handsfree mode, press to select from **VOLUME 1** to **VOLUME 5**.

6.4.5 Initiate a second call (subscription dependent)

During a call, press **OPTION** and select **START 2ND CALL** to put the current call on hold and initiate a second external call. Then enter the phone number of the second call.

6.4.6 Consult phonebook

During a call, press **OPTION** and select **PHONEBOOK** to access and review phonebook entries.

6.5 Call waiting

If you have subscribed to Call Waiting service, the earpiece will emit a beep tone to inform you that there is a second incoming call. The number or

name of the second caller will also be displayed on your phone if you have subscribed to Caller Line Identification service (CLI). Please contact your network provider for more information on this service.

- When you receive a second incoming call while on the phone, press + to put the current call on hold and answer the second call

OR

- Press + to end the current call and answer the second call.
- Press + subsequently to toggle between these 2 calls.

The above operations may be different according to your network.

Note

The call waiting indicator displays during 40 seconds. The missed call information will be displayed in the call log. (see "Access Call log" on page 27)

6.6 Caller Line Identification

Caller Line Identification (CLI) is a special service that you may subscribe from your network operator. If you have subscribed to CLI service, the identity of the caller (caller's number or name) will be displayed on your handset during an incoming call. If you have not subscribed to this service, or if the caller has chosen to withhold the number, the identity of the caller will not be displayed. Please contact

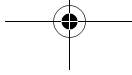
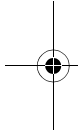
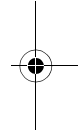



your network provider for more information on this service.

6.7 Using your Phonebook

Your phone can store up to 200 phonebook memories, including 10 direct access memories (☐1☐ to ☐9☐). Depending on your country, Key 1 and Key 2 may be preset to the voice mail number and information service number of your network operator respectively. Each phonebook entry can have a maximum of 24 digits for the phone number and 14 characters for name.

6.7.1 Access phonebook

- 1 Press in idle mode and scroll to browse the phonebook.
 - *The phonebook entries are listed in alphabetical order.*
- 2 To view the details of a phonebook entry, scroll to the phonebook entry and press **SELECT**.
- 3 To dial a number from the phonebook, scroll to the phonebook entry and press **CALL**.

*** Tip**
 Instead of scrolling to browse the phonebook entries, you can press the numeric key corresponding to the first letter of the entry you wish to locate. For example, pressing will show the entries starting with A. Pressing again will show the entries starting with B, etc...

6.7.2 Store a contact in the phonebook

- 1 Press in idle mode, press **SELECT** to enter **PHONEBOOK**, press **SELECT** to enter **NEW ENTRY**.
- 2 Enter the name of the contact (maximum 14 characters) and press **OK**.
- 3 Enter the phone number (maximum 24 digits) and press **OK**.
 - *A validation tone is emitted.*

*** Tip**
 You cannot store a new phonebook entry when the memory is full. In this case, you have to delete existing entries to make space for new entries.

6.7.3 Edit a phonebook entry

- 1 Press in idle mode, press **SELECT** to enter **PHONEBOOK**, scroll to **EDIT ENTRY** and press **SELECT**.
- 2 Scroll to select an entry you wish to edit and press **SELECT**.
- 3 Press **CLEAR** to erase the letters one by one, enter the name and press **OK**.
- 4 Press **CLEAR** to erase the digits one by one, enter the phone number and press **OK**.
 - *A validation tone is emitted.*

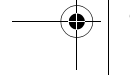
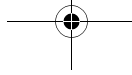
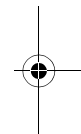

6.7.4 Set melody

With this function you can personalize the melody played when someone in the phonebook calls you.

Note

You need to subscribe to Caller Line Identification service to be able to benefit from this feature.

- 1 Press in idle mode, press to enter **PHONEBOOK**, scroll to **SELECT MELODY** and press .
- 2 Scroll to select an entry you wish to set the melody for and press .
- 3 Press to set or change the melody for the contact.
- 4 Scroll to the melody list and press to confirm.
 - A validation tone is emitted.

6.7.5 Delete a phonebook entry

- 1 Press in idle mode, press to enter **PHONEBOOK**, scroll to **DELETE ENTRY** and press .
- 2 Scroll to select an entry you wish to delete and press .
- 3 **DELETE!** is displayed on the screen. Press to confirm deletion.
 - A validation tone is emitted.

6.7.6 Delete the phonebook list

- 1 Press in idle mode, press to enter **PHONEBOOK**, scroll to **DELETE ALL** and press .
- 2 **DELETE ALL?** is displayed on the screen. Press to confirm deletion.
 - A validation tone is emitted.

6.7.7 Direct Access Memory

You can store up to 9 direct access memories (Keys to). A long press on the keys in idle mode will automatically dial the stored phone number. Depending on your country, Key 1 and Key 2 may be preset to the voice mail number and information service number of your network operator respectively.

6.7.7.1 Store Direct Access Memory

- 1 Press in idle mode, press to enter **PHONEBOOK**, scroll to **DIRECT MEMORY** and press .
- 2 Scroll to select a key (Keys 1 to 9) and press .
 - The stored number is displayed (if any).
- 3 Press to display the menu options.
- 4 Press to select **EDIT**.

- 5 Scroll \uparrow to the entry you wish to store as direct access memory and press \square /SELECT to view the details.
- 6 Press \square /SELECT to confirm.
 - A validation tone is emitted.

6.7.7.2 Delete Direct Access Memory

- 1 Press \square /menu in idle mode, press \square /SELECT to enter **PHONEBOOK**, scroll \uparrow to **DIRECT MEMORY** and press \square /SELECT.
- 2 Scroll \uparrow to select a key (Keys 1 to 9) and press \square /SELECT.
 - The stored number is displayed (if any).
- 3 Press \square /SELECT to display the menu options.
- 4 Scroll \uparrow to **DELETE** and press \square /SELECT.
 - A validation tone is emitted.

6.8 Using the Redial list

The redial list stores the last 20 numbers dialed. A maximum of 24 digits can be displayed for each entry.

6.8.1 Access Redial list

- 1 Press \square /redial in idle mode and scroll \uparrow to browse the redial list.
 - The last number dialed will appear first in the redial list. If the redial number matches a phonebook entry, the name will be displayed instead.

Note

To return to idle mode, press \square /END key.

6.8.2 Save a redial number into the phonebook

- 1 Press \square /redial in idle mode and scroll \uparrow to select an entry. Press \square /SELECT to view the details.
- 2 Press \square /redial and press \square /SELECT to select **SAVE NUMBER**.
- 3 Enter the name of the contact (maximum 14 characters) and press \square /OK.
- 4 Edit the number if necessary and press \square /OK.
 - A validation tone is emitted.

Note

Press \square /CLEAR to delete the last digit or character entered.

6.8.3 Delete a redial number

- 1 Press \square /redial in idle mode and scroll \uparrow to select an entry.
- 2 Press \square /redial, scroll \uparrow to **DELETE** and press \square /OK.
- 3 **DELETE?** is displayed on the screen. Press \square /OK again to confirm deletion.
 - A validation tone is emitted.

6.8.4 Delete the redial list

- 1 Press \square /redial in idle mode.
- 2 Press \square /redial, scroll \uparrow to **DELETE ALL** and press \square /OK.

- 3** **DELETE ALL?** is displayed on the screen.
 Press **OK** again to confirm deletion.

 - A validation tone is emitted.

6.9 Using the Call log

The call log offers quick access to the **CALL LIST** and **ANSWER MACHINE** events. If you have subscribed to Caller Line Identification service, the identity of the caller (caller's number or name) will be displayed together with the date and time of the call*. The **CALL LIST** records the last 50 entries of the incoming calls. The calls (missed and received) are displayed in chronological order with the most recent call at the top of the list. When the call list is empty, the screen displays **LIST EMPTY**.

Note

* If the identity of the caller is withheld or the network does not provide the date and time information, then only the date and time of the call will be displayed. If you have not subscribed to Caller Line Identification service, there will not be any information displayed in the call log.

6.9.1 Access Call log

- 1** Press **call log** in idle mode, scroll **up** to **CALL LIST** and **ANSWER MACHINE** and press **SELECT** to enter the respective sub-menus.

6.9.2 Save a call list entry into the phonebook

- 1** Press **call log** in idle mode and scroll **up** to select an entry. Press **SELECT** to view the details.
- 2** Press **radial** and press **SELECT** to select **SAVE NUMBER**.
- 3** Enter the name of the contact (maximum 14 characters) and press **OK**.
- 4** Edit the number (if necessary) and press **OK**.

 - A validation tone is emitted.

6.9.3 Delete a call list entry

- 1** Press **call log** in idle mode, press **SELECT** to enter **CALL LIST**, scroll **up** to an entry in the call list and press **OPTION**.
- 2** Scroll **up** to **DELETE ENTRY** and press **SELECT**.
- 3** Press **OK** to confirm deletion.

 - A validation tone is emitted.

6.9.4 Delete the call list

- 1** Press **call log** in idle mode, press **SELECT** to enter **CALL LIST**, scroll **up** to an entry in the call list and press **OPTION**.
- 2** Scroll **up** to **DELETE ALL** and press **SELECT**.
- 3** **DELETE ALL?** is displayed on the screen. Press **OK** to confirm deletion.

 - A validation tone is emitted.



6.10 Using the Intercom

Warning

Intercom and call transfer is only possible with handsets registered to the same base station.

This feature is only available when there are at least 2 registered handsets. It allows you to make free internal calls, transfer external calls from one handset to another and use the conference option.

6.10.1 Intercom another handset

Note

If the handset does not belong to ID555 range, this function may not be available.

- 1** Press key in idle mode.
 - *Intercom is established immediately if there are only 2 registered handsets.*
- 2** If there are more than 2 registered handsets, the handset numbers which are available for intercom will be displayed. Scroll to the specific handset you want to call and press .

6.10.2 Transfer an external call to another handset

- 1** During the call, press and hold key to put the external call on hold (the caller can no longer hear you).

- *Intercom is established immediately if there are only 2 registered handsets.*

- 2** If there are more than 2 registered handsets, the handset numbers which are available for intercom will be displayed. Scroll to the specific handset you want to call and press .

- *The called handset rings.*

- 3** Press key on the called handset to answer the internal call, where both internal callers can talk.

- *Intercom is established.*

- 4** Press key on the first handset to transfer the external call to the called handset.

- *The external call is transferred.*

Note

If there is no answer from the called handset, press key to resume the external call.

6.10.3 Answer an external call during intercom

- 1** When there is an incoming external call during an intercom, a new call tone is emitted.
- 2** To end the intercom and answer the external call, press . The handset will ring. Press to answer the external call.
 - *Connection with the external call is established.*

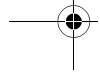
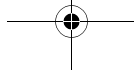
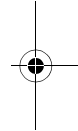
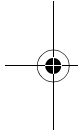



*** Tip**

To put the internal call on hold and answer the incoming external call, press **TALK** key.

6.10.4 Switch between an internal and external call

To switch between an internal or external call, press **int** key.

6.10.5 Establish a three-party conference call

The conference call feature allows one external call to be shared with two handsets (in intercom). The three parties can share the conversation and no network subscription is required.

- 1** During the call, press **int** key to put the external call on hold (the caller can no longer hear you).
 - *Intercom is established immediately if there are only 2 registered handsets.*
- 2** If there are more than 2 registered handsets, the handset numbers which are available for intercom will be displayed. Scroll **↕** to the specific handset you want to call and press **SELECT**.
 - *The called handset rings.*
- 3** Press **TALK** key on the called handset to answer the internal call, where both internal callers can talk.
 - *Intercom is established.*

- 4** Press and hold **int** key for 2 seconds on the first handset to start the three-party conference.
 - **CONFERENCE** will be displayed on the screen once the conference call is established.

*** Tip**

If **CONFERENCE** mode is activated (see "Activate/Deactivate Conference mode" on page 34), a three-party conference call is automatically established if the second handset takes the line when there is already an external call in progress.

6.11 Paging

The paging feature enables you to locate a missing handset if the handset is in range and contains charged batteries.

- 1** Press **(*)0** key on the base station.
 - *All the registered handsets start to ring.*
- 2** Once retrieved, press any key on the handset to end the paging.

Note

If there are no key presses within 30 seconds, the handset and base station will automatically return to idle mode.

*** Tip**



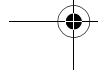
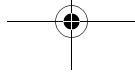

To stop paging, press **(*)0** key on the base station again.



7 Personal settings

7.1 Change the Handset Name

You can name the handset and display the handset name in idle mode. The default handset name of your handset is **PHILIPS**.

- 1 Press  in idle mode, scroll  to **PERSONAL SET** and press , press  to enter **HANDESET NAME**.
- 2 Edit the handset name (maximum 12 characters) and press  **OK** to confirm.
 - A validation tone is emitted and the screen returns to previous menu.



7.2 Handset Tones



7.2.1 Set the Ring Volume



Danger

When setting the ring volume of your phone or when the handset rings during an incoming call, please do not hold the handset too close to your ear as the volume of the ringing tone may damage your hearing.

There are 5 levels of ring volume, including progressive volume.

- 1 Press  in idle mode, scroll  to **PERSONAL SET** and press  to

HANDESET TONES and press  **SELECT**. Press  **SELECT** again to enter **RING VOLUME**









- 2 Scroll  to your desired volume level and press  **OK** to confirm.
 - A validation tone is emitted and the screen returns to previous menu.

Note

When the volume is set to off, the icon  will be displayed on the screen.

7.2.2 Set the Ring Melody

There are 15 polyphonic ring melodies available on your handset.

- 1 Press  in idle mode, scroll  to **PERSONAL SET** and press , scroll  to **HANDESET TONES** and press  **SELECT**. Scroll  to **RING TONES** and press  **SELECT**.
- 2 Scroll  to your desired melody to play the melody.
- 3 Press  **OK** to set the ring melody.
 - A validation tone is emitted and the screen returns to previous menu.

7.2.3 Activate/Deactivate Key Beep

A single beep is emitted when a key is pressed. You can enable or disable the key beep. By default, the key beep is **ON**.

- 1 Press  in idle mode, scroll  to **PERSONAL SET** and

press **SELECT**, scroll to **HANDESET TONES** and press **SELECT**. Scroll to **KEY BEEP** and press **SELECT**.

- 2 Scroll to **ON** or **OFF** and press **OK** to confirm.
 - A validation tone is emitted and the screen returns to previous menu.

7.3 Change the Display Language

Your handset can support different display languages.

- 1 Press **menu** in idle mode, scroll to **PERSONAL SET** and press **SELECT**, scroll to **LANGUAGE** and press **SELECT**.
- 2 Scroll to your desired language and press **SELECT** to confirm.
 - A validation tone is emitted and the screen returns to previous menu.

Tip

Once the display language is set, the option menus on the handset will switch to display in the selected language immediately. However, it will not change the language of the predefined outgoing message of your answering machine.

7.4 Set Contrast Level

There are 5 contrast level options (**LEVEL 1**, **LEVEL 2**, **LEVEL 3**, **LEVEL 4** or **LEVEL 5**). The default contrast level is **LEVEL 2**.

- 1 Press **menu** in idle mode, scroll to **PERSONAL SET** and press **SELECT**, scroll to **CONTRAST** and press **SELECT**.
- 2 Scroll to your desired contrast level (**LEVEL 1**, **LEVEL 2**, **LEVEL 3**, **LEVEL 4** or **LEVEL 5**) and press **SELECT** to confirm.
 - A validation tone is emitted and the screen returns to previous menu.

7.5 Activate/Deactivate Auto Hang-up

This function enables you to end a call automatically by simply replacing the handset on the base station. By default, the Auto Hang-up feature is **ON**.

- 1 Press **menu** in idle mode, scroll to **PERSONAL SET** and press **SELECT**, scroll to **AUTO HANG-UP** and press **SELECT**.
- 2 Scroll to **ON** or **OFF** and press **SELECT** to confirm.
 - A validation tone is emitted and the screen returns to previous menu.

8 Clock and Alarm settings

This feature allows you to set the date, time and alarm settings for your phone. The default date and time is 01-01 and 00:00 respectively.

8.1 Set date and time

- 1** Press **menu** in idle mode, scroll **↑** to **CLOCK & ALARM** and press **OK**, press **SELECT** to enter **SET DATE/TIME**.
- 2** The last stored date is displayed. Enter the current date (dd-mm) and press **OK**.
- 3** The last stored time is displayed. Enter the current time (hh-mm). Press **2** to select **A** (am) or **7** to select **P** (pm) if the time is in 12 hours format. Press **OK** to confirm.
 - A validation tone is emitted.

Note

An error tone will be emitted if an invalid digit is entered in the date/time fields.

Hour: 00 to 12; Minute: 00 to 59
Date: 01 to 31; Month: 01 to 12

Warning

If your phone is connected to an ISDN line through an adaptor, the date & time may be updated after each call. The availability of date & time update is dependent on your network provider.

Please check the date & time settings in your ISDN system or contact your network provider.

8.2 Set date/time format

You can set your preferred date/time format for your phone. The default format is **DD/MM** and **24 HOURS**.

8.2.1 Set time format

- 1** Press **menu** in idle mode, scroll **↑** to **CLOCK & ALARM** and press **OK**, scroll **↑** to **SET FORMAT** and press **SELECT**.
- 2** Press **OK** to enter **TIME FORMAT**.
 - The current setting is displayed.
- 3** Scroll **↑** to select time format display (**12 HOURS** or **24 HOURS**) and press **OK** to confirm.
 - A validation tone is emitted and the screen returns to previous menu.

8.2.2 Set date format

- 1** Press **menu** in idle mode, scroll **↑** to **CLOCK & ALARM** and press **OK**, scroll **↑** to **SET FORMAT** and press **SELECT**.
- 2** Scroll **↑** to enter **DATE FORMAT** and press **OK**.
 - The current setting is displayed.
- 3** Scroll **↑** to select date format display (**DD/MM** or **MM/DD**) and press **OK** to confirm.
 - A validation tone is emitted and the screen returns to previous menu.



8.3 Set alarm

- 1 Press in idle mode, scroll to **CLOCK & ALARM** and press **OK**, scroll to **ALARM** and press **SELECT**.
- 2 Scroll to **OFF**, **ON ONCE** or **ON DAILY** and press **SELECT**.
- 3 If you select **ON ONCE** or **ON DAILY**, enter the time (hh-mm) for the alarm and press to select **A** (am) or to select **P** (pm) if the time is in 12 hours format. Press **OK** to confirm.

- A validation tone is emitted and the screen returns to previous menu.

Note

The alarm tone and alarm icon will only sound/blink for 1 minute when the alarm time is reached. To mute the alarm tone, simply press any key on the handset.

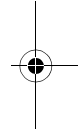
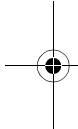

8.4 Set alarm tone

- 1 Press in idle mode, scroll to **CLOCK & ALARM** and press **OK**, scroll to **ALARM TONE** and press **SELECT**.
 - 2 Scroll to **MELODY 1**, **MELODY 2** or **MELODY 3** and press **SELECT** to confirm.
- A validation tone is emitted and the screen returns to previous menu.



Clock and Alarm settings

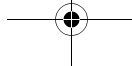









9 Advanced settings



9.1 Easy Call

When activated, the Easy Call feature enables you to dial a number by pressing any key on your handset. This feature is very useful for direct access to emergency services. You can enter up to 24 digits for easy call number.







9.1.1 To activate Easy Call mode

- 1 Press  in idle mode, scroll  to **ADVANCED SET** and press , press  to enter **EASY CALL**.
- 2 Press  to enter **MODE**.
- 3 Scroll  to **ON** and press  to confirm.
- 4 Enter the Easy Call number and press  to confirm.
 - A validation tone is emitted.

9.1.2 To deactivate Easy Call mode







- 1 Long press  (when Easy Call mode has been activated before).
- 2 Scroll  to **OFF** and press  to confirm.

9.1.3 To change Easy Call number

- 1 Press  in idle mode, scroll  to **ADVANCED SET** and press , press  to enter **EASY CALL**.
- 2 Scroll  to **NUMBER** and press  to confirm.
 - The last stored Easy Call number is displayed (if any).
- 3 Enter the easy call number (maximum 24 digits) and press  to confirm.
 - A validation tone is emitted and the screen returns to previous menu.

9.2 Activate/Deactivate Conference mode

When conference mode is activated, you can initiate a three-party conference call with a second handset registered to your base station automatically if the second handset takes the line when there is already an external call in progress. The default setting for this mode is **ON**.

- 1 Press  in idle mode, scroll  to **ADVANCED SET** and press , scroll  to **CONFERENCE** and press  to confirm.
- 2 Scroll  to **ON** or **OFF** and press  to confirm.
 - A validation tone is emitted and the screen returns to previous menu.

9.3 Call Barring

Call barring enables you to restrict selected handsets from dialing a phone number beginning with certain digits. You can set up to 4 different barring numbers, with each number containing up to 4 digits.

9.3.1 To activate/deactivate Call Barring

- 1 Press in idle mode, scroll to **ADVANCED SET** and press **SELECT**, scroll to **CALL BARRING** and press **SELECT**.
- 2 Enter the master PIN when prompted and press **OK** to confirm.

Note

By default, the master PIN is 0000.

- 3 Press **SELECT** to enter **MODE**.
- 4 Scroll to **ON** or **OFF** and press **SELECT** to confirm.
 - A validation tone is emitted and the screen returns to previous menu.

9.3.2 To modify Call Barring number

- 1 Press in idle mode, scroll to **ADVANCED SET** and press **SELECT**, scroll to **CALL BARRING** and press **SELECT**.
- 2 Enter the master PIN when prompted and press **OK** to confirm.

Advanced settings

Note

By default, the master PIN is 0000.

- 3 Scroll to **NUMBER** and press **SELECT**.
- 4 Scroll to **NUMBER 1**, **NUMBER 2**, **NUMBER 3** or **NUMBER 4** and press **SELECT**.
- 5 Enter the barring number (maximum 4 digits) and press **OK** to confirm.
 - A validation tone is emitted and the screen returns to previous menu.

Note

If a restricted number is dialed, the call will not be connected. When this happens, the phone emits an error tone and returns to idle mode.

9.4 Change master PIN

The master PIN is used for setting call barring, registration/unregistration of handsets and for accessing the answering machine remotely. The default master PIN number is 0000. The maximum length of the master PIN is 4 digits. Your handset will prompt you whenever the PIN is required.

Note

The default PIN code is preset to 0000. If you change this PIN code, keep the PIN details in a safe place where you have easy access to them. Do not lose the PIN code.

- 1 Press in idle mode, scroll to **ADVANCED SET** and

press **SELECT**, scroll **UP** to **CHANGE PIN** and press **SELECT**.

- 2 Enter the current master PIN when prompted and press **OK** to confirm.
 - The PIN entered will be shown as asterisks (*) on the screen.
- 3 Enter the new PIN and press **OK**.
- 4 Enter the new PIN again and press **OK** to confirm PIN change.
 - A validation tone is emitted and the screen returns to previous menu.

Note
If you forget your PIN, you will need to reset your phone to its default settings. See next section "Reset Unit" for more details.

9.5 Registration

If you wish to register an additional handset or if you have inadvertently unregistered your phone handset and want to re-register it, follow the procedure described below. This is the procedure for registering ID555 handsets. The procedures may vary according to the handset you want to register. In this case, please refer to the manufacturer of the additional handset. Additional handsets must be registered to the base unit before you can use them. Up to 5 handsets can be registered to one base station. The master PIN is required before you can register or unregister handsets.

36

Note
By default, the master PIN is 0000.
To register your handset manually:
The Master PIN is required before you can register or unregister handsets.

Note
By default, the Master PIN is 0000.
1 On the base station, press and hold **CALL** for approximately 5 seconds. The base station emits a beep when it is ready to accept registration.

2 On the handset, press **menu** key, scroll **UP** to **ADVANCED SET** and press **SELECT**, scroll **UP** to **REGISTRATION** and press **SELECT**.

Note
If no action is taken on the handset within 10 seconds, the registration procedure will be aborted. If this happens, repeat Step 1.

3 Enter the Master PIN when prompted and press **OK** to confirm.

Note
By default, the Master PIN is 0000.
4 **WAITING_** is displayed on the screen.

Note
If no base is found within a certain period, the handset returns to idle mode.

9.6 Unregister a handset

- 1 Press in idle mode, scroll to **ADVANCED SET** and press **SELECT**, scroll to **UNREGISTER** and press **SELECT**.
- 2 Enter the master PIN when prompted and press **OK** to confirm.

Note

By default, the master PIN is 0000.

- 1 Scroll to select the handset number to unregister and press **SELECT**.
 - A validation tone is emitted to indicate successful unregistration and the screen shows **UNREGISTERED**.

Note

If no action is taken on the handset within 15 seconds, the unregistration procedure will be aborted and the handset returns to idle mode. To unregister a handset that does not belong to the ID555 range, you can only use the ID555 handset to unregister it.

9.7 Reset Unit

You can reset your phone to its default settings with this feature.

Warning

Upon reset, all your personal settings, call log and redial list entries will be deleted and the phone will return to its default settings. However, your phonebook as well as the unread

messages of your answering machine will remain unchanged after reset.

Note

You may have to configure your phone once again.

- 1 Press in idle mode, scroll to **ADVANCED SET** and press **SELECT**, scroll to **RESET** and press **SELECT**.
- 2 **RESET?** is displayed on the screen. Press **OK** to confirm.
 - A validation tone is emitted.
 - The unit is reset to its default settings (see "Default settings" on page 37).

9.8 Default settings

Ringer Volume	LEVEL 2
Ringer Melody	FLICK
Earpiece Volume	VOLUME 3
Speaker Volume	VOLUME 3
Key Beep	ON
Contrast	LEVEL 2
Auto Hang-up	ON
Alarm clock	OFF
Barring mode	OFF
Easy call	OFF
Handset Name	PHILIPS
Date/Time	01/01/2008; 00:00
Master PIN	0000
Conference	OFF

Answering Machine

Answer Mode	ANSWER & REC.
Number of rings before answer	5
Outgoing Messages	Predefined for ANSWER & REC. mode
Handset screening	OFF
Base speaker	LEVEL 5
Remote access	DEACTIVATED

9.9 Set area code

This feature is useful when you have subscribed to Caller Line Identification service. It allows you to set an area code in your ID555. Once the local area code is set, the phone automatically filters the area code for all incoming calls, by removing the area code for local calls and retaining the area code for calls from other areas. If it is a local call, then only the phone number of the caller is displayed during an incoming call or when you call the number from the call log. If it is a long distance call, then both the area code and phone number will be displayed in a proper format to be dialed out directly from the call log, or saved into the phonebook.

Note

You can enter a maximum of 3 digits for the area code. You need to subscribe to Caller Line Identification

service to be able to see the caller's number or name in the call log. See "Using the call log" on chapter 6.9 for details.

- 1 Press in idle mode, scroll to **ADVANCED SET** and press **SELECT**, scroll to **AREA CODE** and press **SELECT**.
- 2 Enter the local area code (maximum 3 digits) and press **OK** to save.
 - A validation tone is emitted and the screen returns to previous menu.

9.10 Set Auto Prefix

This feature allows you to define a prefix number to be added to the beginning of a number during predialing (see "Predialing" on page 20). You can also use this feature to add a detect string to match and replace the first few digits of the number during predialing. You can enter up to a maximum of 5 digits for the detect string and 14 digits for the auto prefix number.

Note

The use of your ID555 cannot be guaranteed with all types of PABX.

- 1 Press in idle mode, scroll to **ADVANCED SET** and press **SELECT**, scroll to **AUTO PREFIX** and press **SELECT**.
- 2 **DETECT DIGIT** is displayed on the screen.

- The last stored detect string is displayed (if any).

- Enter a detect string number (maximum 5 digits) and press **OK** to confirm.
- PREFIX** is displayed on the screen.
 - The last stored prefix number is displayed (if any).
- Enter the prefix number (maximum 14 digits) and press **OK** to confirm.
 - A validation tone is emitted and the screen returns to previous menu.

Note

If no detect string (blank) is entered, the prefix number will be automatically added to the predial number after **TALK** key is pressed. For numbers starting with *, # or a pause (P), the prefix number will not be added to the predial number after **TALK** key is pressed.

9.11 Change Flash time

Flash time (or dial delay) is the time delay by which the line will be disconnected after you press **TALK** key. It can be set to short, medium or long.

The default value of flash time that is preset in your handset should be the best suited for your country network and therefore you should not need to change it.

- Press **menu** in idle mode, scroll **ADVANCED SET** and press **SELECT**, scroll to

FLASH TIME and press **SELECT**.

- Scroll to **SHORT, MEDIUM** or **LONG** and press **SELECT** to confirm.
 - A validation tone is emitted and the screen returns to previous menu.

9.12 Change the Dial Mode

The default value for dial mode that is preset in your handset should be the best suited for your country network and therefore you should not need to change it.

- Press **menu** in idle mode, scroll to **ADVANCED SET** and press **SELECT**, scroll to **DIAL MODE** and press **SELECT**.
- Scroll to **TONE** or **PULSE** and press **SELECT** to confirm.
 - A validation tone is emitted and the screen returns to previous menu.

9.13 Set first ring

When this function is set to Off, the first ring from a voice call will not sound. This is particularly useful in countries where calling line identity is sent after the first ring. Consequently, the phones in the house will not ring when a message arrives.

- Press **menu** in idle mode, scroll to **ADVANCED SET** and press **SELECT**, scroll to



FIRST RING and press

SELECT.

- 2 Scroll to **ON** or **OFF** and press **OK** to confirm.

- *A validation tone is emitted and the screen returns to previous menu.*

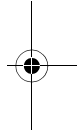
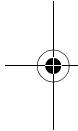

40

Advanced settings

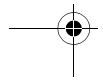
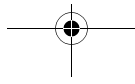

10 Telephone answering machine (TAM)

Your phone features an answering machine that records unanswered calls when it is activated. The answering machine can store up to 99 messages. The maximum recording time is 30 minutes (including all your personalized outgoing messages).





You can use the control keys on the base station to perform the basic functions of the answering machine such as message playback, deleting messages and adjustment of volume on the base station. For a description of each function of the control keys on the base station, please see "Overview of the base station" on page 14 for more details.

You can also use the answer machine menu on the handset to access the answering machine functions. There is also a menu to set the answering machine options.

To begin, press  key on your base station to switch on the answering machine (if it is switched off). Alternatively, you may switch on the answering machine via your handset (see "Switch the Answering Machine On/Off via handset" on page 44).

10.1 Play

10.1.1 Answering machine control keys on the base station

Buttons on the base station	Description
	Press to turn on/off the answering machine
	Press to play the message or stop the message playback
	Press to delete the current message Press and hold for two seconds to delete all the old messages in idle mode
	Press once to replay current message during message playback Press twice to go back to previous message during message playback
	Press to skip the current message and play the next message

	Decrease (-) or increase (+) speaker volume during message playback
	Press to page the handset Press and hold for more than three seconds to start registration procedure

10.1.2 Playback of new messages via handset

The last recorded message is played first via the loudspeaker. When all new messages have been played, the answering machine will stop and the icon stops blinking.

- 1 Press in idle mode, scroll to **ANSWER MACHINE** and press **SELECT**, press **SELECT** again to enter **PLAY** menu.

2 During playback, you can:

Adjust volume	Press key.
Stop playback	Press STOP to end the message.
Repeat	Press OPTION , scroll to REPEAT and press SELECT to play the message again.
Next message	Press OPTION , scroll to NEXT and press SELECT .
Previous message	Press OPTION , scroll to PREVIOUS and press SELECT .
Delete message	Press OPTION , scroll to DELETE and press SELECT .
Switch the playback to earpiece	Press key.

* Tip

You can also playback messages by pressing key in idle mode, scroll to **ANSWER MACHINE** and press **SELECT**, press **SELECT** again to enter **PLAY** menu.

10.1.3 Playback of old messages via handset

Old messages can only be played if there are no new messages. The first recorded message will be played first and the next message will be played automatically until there are no more messages.

- 1 Press in idle mode, scroll to **ANSWER MACHINE** and press **SELECT**, press **SELECT** again to enter **PLAY** menu.
- 2 Press **SELECT**.
 - *The first recorded message will start to play until the last recorded message.*
- 3 During message playback, you can press to select the available options (see options available under "Playback of new messages via handset" on page 42).

10.2 Delete all messages

Note

Unread messages will not be deleted.

Warning

Messages deleted cannot be recovered.

- 1 Press in idle mode, scroll to **ANSWER MACHINE** and press **SELECT**, scroll to **DELETE ALL** and press **SELECT**.
- 2 **DELETE ALL?** is displayed on the screen. Press **OK** to confirm deletion of all your messages.
 - *A validation tone is emitted and the screen returns to previous menu.*

10.3 Set the Answer mode

There are 2 answer modes available: Answer only, and Answer & record.

Telephone answering machine (TAM)

By default, the answer mode is **ANSWER & REC.**, by which your correspondent can leave a message on the answering machine. This can be changed to **ANSWER ONLY** mode, by which your correspond cannot leave any messages on the answering machine.

- 1 Press in idle mode, scroll to **ANSWER MACHINE** and press **SELECT**, scroll to **ANSWER MODE** and press **SELECT**.
- 2 Scroll to **ANSWER & REC.** or **ANSWER ONLY** and press **SELECT**.
 - *The answer mode is set.*

Note

Depending on the answer mode you have selected, the appropriate default outgoing message is played once the answering machine picks up an incoming call.

10.4 Personalized Outgoing Message

10.4.1 Record your Personalized Outgoing Message

This personal outgoing message replaces the default ones. To revert to the default outgoing message, simply delete the personal outgoing message you have recorded. If you are not satisfied with the recorded outgoing message, simply record a new message to overwrite the old one.

- 1 Press in idle mode, scroll

⊕ to **ANSWER MACHINE** and press **SELECT**, scroll ⊕ to **RECORD OGM** and press **SELECT**.

- 2 Scroll ⊕ to **ANSWER & REC.** or **ANSWER ONLY** and press **SELECT**.
- 3 Scroll ⊕ to **RECORD OGM** and press **SELECT**.
 - The recording starts.
- 4 Press **SAVE** to save your recording.
 - The recorded message will be played and the screen returns to previous menu once it has finished playing. To stop the playback, press **OK**.

Note

The maximum length of an outgoing message is 2 minutes.

10.4.2 Playback your Personalized Outgoing Message

- 1 Press **menu** in idle mode, scroll ⊕ to **ANSWER MACHINE** and press **SELECT**, scroll ⊕ to **RECORD OGM** and press **SELECT**.
- 2 Scroll ⊕ to **ANSWER & REC.** or **ANSWER ONLY** and press **SELECT**.
- 3 Press **SELECT** to enter **PLAY**.
 - The previously recorded outgoing message (if any) is played, and then the screen returns to previous menu.

10.4.3 Delete your Personalized Outgoing Message

- 1 Press **menu** in idle mode, scroll ⊕ to **ANSWER MACHINE** and press **SELECT**, scroll ⊕ to **RECORD OGM** and press **SELECT**.
- 2 Scroll ⊕ to **ANSWER & REC.** or **ANSWER ONLY** and press **SELECT**.
- 3 Scroll ⊕ to **DELETE** and press **SELECT**.
 - The recorded message is deleted.

10.5 Switch the Answering Machine On/Off via handset

- 1 Press **menu** in idle mode, scroll ⊕ to **ANSWER MACHINE** and press **SELECT**, scroll ⊕ to **ANSWER ON/OFF** and press **SELECT**.
- 2 Scroll ⊕ to **ON** or **OFF** and press **SELECT** to confirm.
 - A validation tone is emitted and the screen returns to previous menu.

10.6 Answering Machine settings

10.6.1 Ring Delay

This is the number of rings before the answering machine answers and starts playing your greeting message.

Telephone answering machine (TAM)

You can set the answering machine to start playing your greeting message after 3 to 8 rings or **ECONOMY**. The default ring delay is 5.

- 1 Press in idle mode, scroll to **ANSWER MACHINE** and press **SELECT**, scroll to **SETTINGS** and press **SELECT**, press **SELECT** to enter **RING DELAY**.
- 2 Scroll to your desired ring delay setting (3 to 8 rings or **ECONOMY**) and press **SELECT** to confirm.
 - A validation tone is emitted and the screen returns to previous menu.

Tip

Economy mode can save you the cost of a long-distance call when you check your messages remotely. If there are new messages in your answering machine, the outgoing message will start playing after 3 rings. If there are no new messages, the outgoing message will be played after 5 rings. Hence, if you want to check if you have any messages without incurring call charges, you can hang up the call after the 4th ring.

10.6.2 Remote Control Access

If you are far away from home and want to check the messages on your answering machine, you can make use of the remote access feature to check your messages using another phone. Once you dial your home number

from any other phone and enter the remote access code*, you will be able to obtain the messages on your answering machine. The keypad on the phone you use to dial acts like the functions on your answering machine where you can play or delete messages, turn your answering machine on or off, etc.

Note

This feature is deactivated by default. * Remote access code (which is the same as your master PIN code) prevents any unauthorised remote access of your answering machine. See chapter 10.6.2.2 for more information.

10.6.2.1 Activate/Deactivate Remote Access

- 1 Press in idle mode, scroll to **ANSWER MACHINE** and press **SELECT**, scroll to **SETTINGS** and press **SELECT**, scroll to **REMOTE ACCESS** and press **SELECT**.
- 2 Scroll to **ACTIVATE** or **DEACTIVATE** and press **SELECT** to confirm.
 - A validation tone is emitted and the screen returns to previous menu.









10.6.2.2 Controlling the Answering Machine from an external call

- 1 From another phone, dial home.
 - The answering machine answers and starts playing your greeting message.
- 2 Within 8 seconds, press # key on the phone you use to dial and enter the remote access code (same as your master PIN code).
 - If the remote access code is incorrect, an error tone is emitted. Enter the access code again until you get the correct number.
 - If you did not enter the remote access code within 10 seconds, the answering machine will drop the line immediately.
 - If the remote access code (same as your master PIN code) is correct, you will hear a validation tone.
 - New messages (if any), will be played automatically and stop when there are no more new messages.

 **Note**

If there are no new messages, the answering machine will not play any messages.

The following table indicates how to access the below features during remote access procedure:

Press	To
	Press once to replay the current message or twice to go to previous message
	Play old messages
	Go to next message
	Delete current message
	Turn on the answering machine
	Stop current message playback
	Turn off the answering machine
	Enter the remote access code if the answering machine is on and outgoing message is playing

10.7 Call Screening

10.7.1 Call screening on handset

If Handset call screening is set to **ON**, you can hear incoming messages via the handset speaker and decide whether or not to take the call. To take the call, press . This feature is deactivated by default.



- 1 Press in idle mode, scroll to **ANSWER MACHINE** and press **SELECT**, scroll to **SETTINGS** and press **SELECT**, scroll to **HS SCREENING** and press **SELECT**.
- 2 Scroll to **ON** or **OFF** and press **SELECT**.
 - A validation tone is emitted and the screen returns to previous menu.



10.7.2 Call screening on base

You can use and to adjust the speaker's volume during call screening. The lowest volume level turns call screening off.

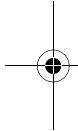

10.7.3 Set Voice Language

This menu allows you to change the language of the predefined outgoing message. The availability of this menu and the language options available are country dependent.

- 1 Press in idle mode, scroll to **ANSWER MACHINE** and press **SELECT**, scroll to **SETTINGS** and press **SELECT**, scroll to **VOICE LANGUAGE** and press **SELECT**.
 - The current selected language is highlighted.

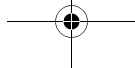
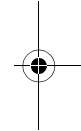



11 Technical data

Display

- Progressive LCD backlight

General telephone features

- Dual mode caller name & number identification
- 15 polyphonic ringer melodies

Phonebook list, Redial list and Call log

- Phonebook list with 200 entries
- Redial list with 20 entries
- Call log with 50 entries

Battery

- 1 Li-ion polymer 500mAh battery

Radio specifications

- Frequency Band: 1880 - 1900 MHz
- Maximum output power: 250 mW

Power Consumption

- Power consumption at idle mode: around 800mW

Weight and dimensions

- Handset: 74 grams
- 144 x 13 x 43 mm (H x D x W)
- Base: 143 grams
- 70 x 85 x 128 mm (H x D x W)

Temperature range

- Operation: Between 0 and 35° C (32 to 95° F).
- Storage: Between -20 and 45° C (-4 to 113° F).

Relative humidity

- Operation: Up to 95% at 40°C
- Storage: Up to 95% at 40°C

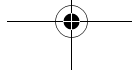
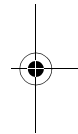
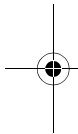



12 Frequently asked questions

www.philips.com/support

In this chapter, you will find the most frequently asked questions and answers about your phone.

Connection

The handset does not switch on!

- Charge the batteries: Put the handset on the base station to charge. After a few moments, the phone will switch on.

The handset does not charge!

- Check charger connections.

icon is not blinking during charge!

- Battery is full: There is no need to charge the battery.
- Bad battery contact: Adjust the handset slightly.
- Dirty contact: Clean the batteries contact with a dry cloth.
- Wrong batteries installed: Use only ALi-ion rechargeable battery supplied with your unit. There could be risk of battery leakage if you use alkaline batteries or other battery types.

Communication is lost during a call!

- Charge the battery
- Move closer to the base station.

The phone is "Out of range"!

- Move closer to the base station.

WARNING BATT. is displayed on handset!

- Use only Li-ion rechargeable battery supplied with your unit. There could be risk of battery leakage if you use alkaline batteries or other battery types.

Set-up

SEARCHING... is displayed on handset and icon is blinking!

- Move closer to the base station.
- Make sure that your base station is on.
- Reset your unit and restart handset registration (see "Registration" on page 36).

Sound

Handset does not ring!

Check that the **RING VOLUME** is not set to off, and make sure  icon is

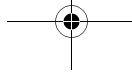



not displayed on the screen (see "Set the Ring Volume" in chapter 7.2.1).

Caller cannot hear me at all!
Microphone may be muted: During a call, press **[mute]**.

There's no dialing tone!

- No power: Check the connections.
- Batteries are empty: Charge the batteries.
- Move closer to the base station.
- Wrong line cable used: Use the line cable provided.
- Line adaptor is required: Connect the line adaptor to the line cord.

Caller cannot hear me clearly!

- Move closer to the base station.
- Move the base station at least one metre away from any electronic appliances.

Frequent noise interference on my radio or television!

- Move the base station as far away as possible from the electrical appliances.

Product behavior

Keypad does not work!

- Unlock your keypad: Long press **[*#]** in idle mode.

The handset warms up when making a long call!

- This is a normal behavior. The handset consumes energy while calling.

The handset cannot be registered to the base station!

- Maximum number of handsets (5) has been reached. To register a new handset, unregister an existing handset.
- Remove and replace the handset batteries.
- Try again by disconnecting and connecting the base station power supply and follow the procedure to register a handset.
- Make sure that you have entered the correct PIN code. If you have not changed it, by default it is 0000.

Caller's number is not displayed!

- Service is not activated: Check your subscription with your network operator.

I cannot change the settings of my voice mail

- Operator voice mail is managed by your operator and not the phone itself. Please contact your operator should you want to change the settings.

Poor audio quality and the antenna icon  is blinking!

- The indoor and outdoor range of the phone is up to 50 metres and 300 metres respectively. When the handset moves beyond the operation range, the antenna icon  will blink.

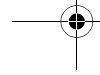
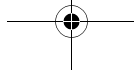
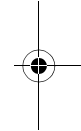
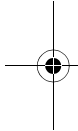



My handset keeps going into idle mode!

- If there are no key presses for 30 seconds, the handset will automatically return to idle mode. It will also return to idle mode automatically when you place the handset back on the base station.

Phonebook entry cannot be stored and MEMORY FULL is displayed!

- Delete an entry to free memory before saving your contact again.

The Master PIN code is wrong!

- The default master PIN is 0000.
- If it has been changed before, and you cannot remember the new one, reset the handset to revert to the default master PIN code (see "Reset Unit" in chapter 9.7).

The answering machine does not record messages!

- Memory is full: Delete your old messages.
- The **ANSWER ONLY** mode has been activated. Deactivate **ANSWER ONLY** and activate **ANSWER & REC.** mode (see "Set the Answer mode" in chapter 10.3).

Remote control access does not work!

- Activate Remote Control Access (see "Remote Control Access" in chapter 10.6.2).

The phone hangs up during remote access!

- You have taken more than 8 seconds to enter the Master PIN code. Enter the code again within 8 seconds.

Answering machine stops before the recording is finished!

- Memory is full: Delete your old messages.

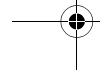
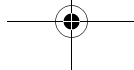
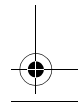
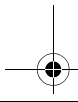
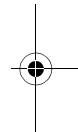
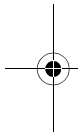



13 Index

A

Accessories 10
Alarm 33
Alarm tone 33
Answer a call 21
Answer an external call 28
Answering Machine mode 43
Auto Answer 31

C

Call Barring 35
Call in progress 22
Call log 20, 27
Call Screening 46
Call waiting 23
Charge battery 16
Clock and Alarm 32
Conference call 29
Connect base station 15
Contrast 31

D

Date and time 32
Default settings 40
Delete a call list entry 27
Delete a phonebook entry 25
Delete a redial number 26
Delete call list 27
Delete redial list 26
Dial Mode 39
Direct dialing 20
Display icons 13

E

Edit a phonebook entry 24
End a call 21

52

F

First ring 39

H

Handset Name 30
Handset Tones 30
Handsfree answering 21

I

Install battery 16
Install phone 15
Intercom 28

K

Key Tone 30
Keypad lock/unlock 22

L

Language 31
LED indicator 14
Loudspeaker mode 23
Loudspeaker volume 23

M

Make a call 20
Master PIN 35
Menu structure 17
Mute 22

O

Overview of the base station 14
Overview of your phone 11

P

Page 42
Paging 29

Index

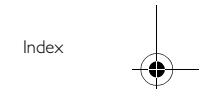
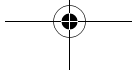



Personalized Outgoing Message 43
Phonebook 21, 24
Predialing 20

R

Recall time 39
Recycling and disposal 5, 8
Redial list 20, 26
Registration 36
Remote Control Access 45
Reset Unit 37
Ring Delay 44
Ring Melody 30
Ring Volume 30

S

Save a redial number 26
Set area code 38
Store a contact 24
Switch calls 29
Switch handset on/off 22

T

Telephone answering machine 41
Text or number entry 22

U

Unmute 22
Unregister 37

V

Voice Language 47
Voice mail 24, 25
Volume 22

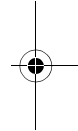
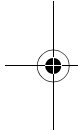

Index

53

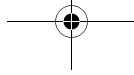

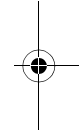
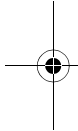

© 2008 Koninklijke Philips Electronics N.V.
All rights reserved
Reproduction in whole or in part is prohibited
without the written consent of the copyright owner

Document number: 3111 285 48871 (US-EN)



Printed in China

