

PHILIPS

SP9830

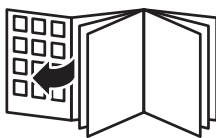

skinIQ



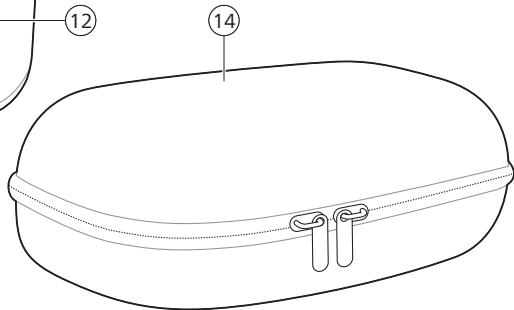
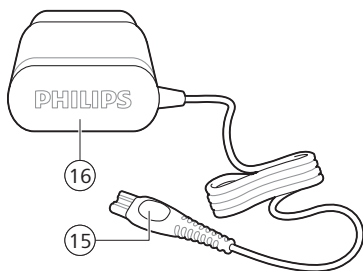
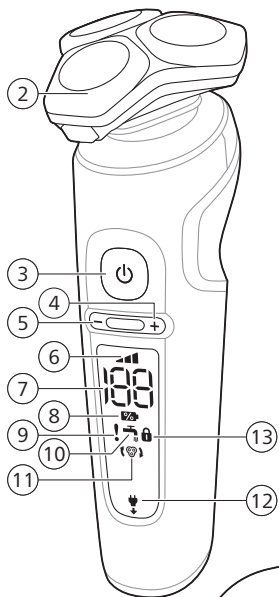
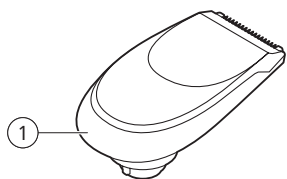

English 6
简体中文 26

Introduction

Congratulations on your purchase and welcome to Philips! To fully benefit from the support that Philips offers, register your product at **www.philips.com/welcome**.

Please read this user manual, as it contains information about the features of this shaver as well as some tips to make shaving easier and more enjoyable.

General description (Fig. 1)

- 1 Click-on precision trimmer attachment
- 2 Shaving unit with hair chamber
- 3 On/off button
- 4 Personal comfort settings increase button
- 5 Personal comfort settings decrease button
- 6 Personal comfort settings bar
- 7 Battery charge percentage
- 8 Battery charge indicator
- 9 Notification symbol
- 10 Cleaning reminder
- 11 Replacement reminder
- 12 Unplug for use symbol
- 13 Travel lock symbol
- 14 Pouch
- 15 Small plug
- 16 Supply unit

Important safety information

Read this important information carefully before you use the appliance and its accessories and save it for future reference. The accessories supplied may vary for different products.

Only use the product for its intended purpose. Read this important information carefully before you use the product and its batteries and accessories, and save it for future reference. Misuse can lead to hazards or serious injuries. Accessories supplied may vary for different products.

Warning



- Keep the supply unit dry.
- This symbol means: Forbidden to clean under a running tap.
- This shaver is waterproof. It is suitable for use in the bath or shower and for cleaning under the tap. For safety reasons, the shaver can therefore only be used without cord.
- This symbol means: Suitable to be used in the shower. It is allowed to use this appliance close to a bathtub, shower or other containers filled with water.
- Do not modify the supply unit.
- This appliance can be used by children aged from 8 years and above and persons with reduced physical, sensory or mental capabilities or lack of experience and knowledge if they have been given supervision or instruction concerning use of the appliance in a safe way and understand the hazards involved. Children shall not play with the appliance. Cleaning and user maintenance shall not be made by children without supervision.
- Unplug the appliance before cleaning it with water.
- Do not use a damaged appliance. Replace damaged parts with new Philips parts.
- Do not use the supply unit in or near wall sockets that contain an electric air freshener to prevent irreparable damage to the supply unit.
- Because of hygiene, only one person should use the appliance.
- Only use cold or lukewarm water to clean the appliance.
- Never use compressed air, scouring pads, abrasive cleaning agents or aggressive liquids to clean the appliance.

- Water may drip from the socket at the bottom of the shaver when you rinse it. This is normal and not dangerous because all electronics are enclosed in a sealed power unit inside the shaver.
- Only use original Philips accessories or consumables. Only use detachable supply unit HQ8505.
- Charge, use and store the product at a temperature between 5 °C and 35 °C.
- Keep product and batteries away from fire and do not expose them to direct sunlight or high temperatures.
- If the product becomes abnormally hot or smelly, changes color or if charging takes longer than usual, stop using and charging the product and contact Philips.
- Do not place products and their batteries in microwave ovens or on induction cookers.
- Do not open, modify, pierce, damage or dismantle the product or battery to prevent batteries from heating up or releasing toxic or hazardous substances. Do not short-circuit, overcharge or reverse charge batteries.
- If batteries are damaged or leaking, avoid contact with the skin or eyes. If this occurs, immediately rinse well with water and seek medical care.

Electromagnetic fields (EMF)

This Philips appliance complies with all applicable standards and regulations regarding exposure to electromagnetic fields.

The display

Note: Remove any sticker or protective foil from the display before using the product.

Charging



When the shaver is charging, the battery charge indicator on the shaver flashes white.

The battery charge is indicated by the battery charge percentage flashing on the display, which is shown when the shaver is moved.

Quick charge: After approx. 5 minutes charging, the shaver contains enough energy for one shave.

Battery fully charged

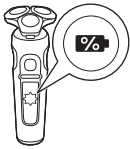

When the battery is fully charged, the battery charge indicator lights up white continuously.

Note: When the battery is full, the display switches off automatically after 15 minutes.

The battery charge percentage lights up white continuously when the shaver is moved.

Battery low



When the battery is almost empty, the battery charge indicator flashes orange and the shaver beeps. At this point there is enough energy left for one shave.

Remaining battery charge



The remaining battery charge is indicated by the battery charge percentage shown on the display.

Personal comfort settings

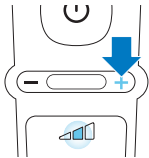

The shaver has a feature that allows you to personalize your settings. Depending on your personal shaving needs, choose between three settings, from low to high: comfort, dynamic or efficiency. When you press the button on the left or right of the display, the segment of the personal comfort settings bar lights up to indicate the selected setting. To select a lower or higher setting, press the button on the left or right of the display.

Cleaning reminder



Clean the shaver after every use for optimal performance (see 'Cleaning and maintenance'). When you switch off the shaver, the cleaning reminder flashes to remind you to clean the shaver.

Travel lock

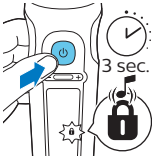

When you are going to travel, you can lock the shaver to prevent it from accidentally switching on (see 'Activating the travel lock').

Replacement reminder



For maximum shaving performance, replace the shaving heads every two years. The shaver is equipped with a replacement reminder which reminds you to replace the shaving heads. The shaver beeps, the replacement reminder lights up and the arrows flash to indicate that you have to replace the shaving heads.

Note: After replacing the shaving heads, you can reset the replacement reminder by pressing the on/off button for 7 seconds. If you do not reset the replacement reminder, the shaver resets automatically after 9 shaves.

'Unplug for use' reminder





The 'unplug for use' symbol flashes to remind you to disconnect the shaver from the wall socket before you can switch it on.

Notification symbol



Overheating

If the shaver overheats during charging, the notification symbol flashes. When this happens, the shaver automatically stops charging. Charging continues once the temperature of the shaver has decreased to the normal level after approx. 10 minutes.



Blocked shaving heads

If the shaving heads are blocked, the notification symbol continuously lights up red. The replacement reminder and the cleaning reminder alternately flash white and the shaver beeps. In this case, the motor cannot run because the shaving heads are dirty or damaged. If the shaving heads are dirty, you have to clean them. If the shaving heads are damaged, you have to replace them.

Charging

Charge the shaver before you use it for the first time and when the display indicates that the battery is almost empty.

Charging takes approx. 1 hour. A fully charged shaver has a shaving time of up to 60 minutes.

Note: You cannot use the shaver while it is charging.

Quick charge

After approx. 5 minutes of charging the shaver contains enough power for one shave.

Charging with the supply unit

- 1 Make sure the shaver is switched off.



- 2 Put the small plug in the shaver and put the supply unit in the wall socket.
The display of the shaver indicates that the shaver is charging.
- 3 After charging, remove the supply unit from the wall socket and pull the small plug out of the shaver.

Note: When the battery is full, the display switches off automatically after 15 minutes.

Using the shaver

Always check the shaver and all accessories before use. Do not use the shaver or any accessory if it is damaged, as this may cause injury. Always replace a damaged part with one of the original type.

This symbol indicates that the shaver can be used in the bath or shower.



- Use this shaver for its intended household use as described in this manual.
- For hygienic reasons, the shaver should only be used by one person.
- Trimming is easier when the skin and hair are dry.

Note: This shaver is waterproof. It is suitable for use in the bath or shower and for cleaning under the tap. For safety reasons, the shaver can only be used without cord.

Switching the shaver on and off

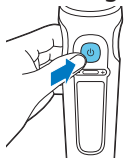

- 1 To switch on the shaver, press the on/off button once.
The battery charge percentage lights up for a few seconds.
- 2 To switch off the shaver, press the on/off button once.
The battery charge percentage lights up for a few seconds and shows the remaining battery charge.

Shaving

Skin adaptation period

Your first shaves may not bring you the result you expect and your skin may even become slightly irritated. This is normal. Your skin and beard need time to adapt to any new shaving system. To allow your skin to adapt to this

new appliance, we advise you to shave regularly (at least 3 times a week) and exclusively with this appliance for a period of 3 weeks.

Shaving tips

- For the best results on skin comfort, pre-trim your beard if you have not shaved for 3 days or longer.
- Select your personal comfort setting (see 'Personal comfort settings').

Dry shaving

- 1 Switch on the shaver.
- 2 Move the shaving heads over your skin in circular movements to catch all hairs growing in different directions. Make sure each shaving head is fully in contact with the skin. Exert gentle pressure for a close, comfortable shave.



Note: Do not press too hard, as this can cause skin irritation.

- 3 Switch off and clean the shaver after each use (see 'Cleaning and maintenance').
The display lights up for a few seconds to show the remaining battery charge.

Wet shaving

For a more comfortable shave, you can also use this appliance on a wet face with shaving foam or shaving gel.

- 1 Apply some water to your skin.



- 2 Apply shaving foam or shaving gel to your skin.



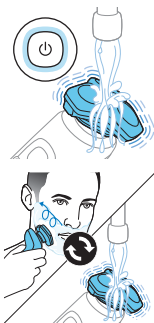

- 3 Rinse the shaving unit under the tap to ensure that the shaving unit glides smoothly over your skin.
- 4 Switch on the shaver.
- 5 Move the shaving heads over your skin in circular movements to catch all hairs growing in different directions. Make sure each shaving head is fully in contact with the skin. Exert gentle pressure for a close, comfortable shave.

Note: Do not press too hard, as this can cause skin irritation.

Note: Rinse the shaving unit regularly to ensure that it continues to glide smoothly over your skin.

- 6 Dry your face.
- 7 Switch off the shaver and clean it after each use.

Note: Make sure that you rinse all foam or shaving gel off the shaver.

Using click-on attachments

Removing or attaching click-on attachments

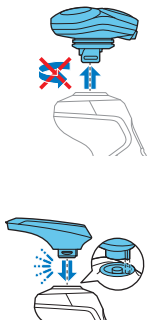

- 1 Make sure the shaver is switched off.
- 2 Pull the attachment straight off the shaver.

Note: Note: Do not twist the attachment while you pull it off the shaver.

- 3 Insert the lug of the attachment into the slot in the top of the shaver. Then press down the attachment to attach it to the shaver ('click').

Using the precision trimmer attachment

You can use the precision trimmer attachment to touch up your beard, sideburns and moustache.

- 1 Attach the attachment to the appliance ('click').
- 2 Switch on the appliance.



- 3 Hold the precision trimmer perpendicular to the skin and move it downwards while exerting gentle pressure.
- 4 Switch off the appliance and clean the attachment after use.

Travel lock

You can lock the shaver when you are going to travel to prevent it from switching on accidentally.

Activating the travel lock

- 1 Press the on/off button for 3 seconds to use the travel lock mode.

While you activate the travel lock, the travel lock symbol lights up briefly and the shaver produces a short sound. When the travel lock is activated, the travel lock symbol flashes.

If you try to switch on the shaver while the travel lock is active, the travel lock symbol flashes.

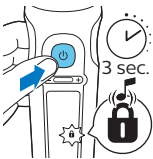

Deactivating the travel lock

- 1 Press the on/off button for 3 seconds.

While you deactivate the travel lock, the travel lock symbol lights up briefly and the shaver produces a short sound. The shaver switches on and is now ready for use again.

Note: The shaver unlocks automatically when it is connected to the wall socket.



Cleaning and maintenance

Regular cleaning guarantees better shaving results.

Never clean, remove or replace the shaving unit while the shaver is switched on.

Do not apply pressure to shaving head guards.

Do not touch shaving heads with hard objects as this may dent or damage the precision-made slotted guards.

Do not use compressed air, abrasives, scourers or aggressive liquids such as petrol or acetone to clean the shaver.

Cleaning the shaver under the tap

Clean the shaver after every shave for optimal performance.

Always check if the water is too hot, to prevent burning your hands.

Never dry the shaving unit with a towel or tissue, as this may damage the shaving heads.

While rinsing the shaving unit, water may drip out of the bottom of the shaver. This is a normal occurrence.

- 1 Switch on the shaver.
- 2 Rinse the shaving unit under a warm tap.

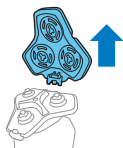

- 3 Switch off the shaver. Pull the shaving head holder off the bottom part of the shaving unit.

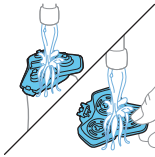

- 4** Rinse the hair chamber and shaving head holder under the tap.



While rinsing the shaving unit, water may drip out of the bottom of the shaver. This is a normal occurrence.



- 5** Carefully shake off excess water and let the shaving head holder air-dry completely.

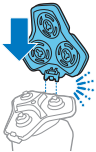

- 6** Attach the shaving head holder to the bottom part of the shaving unit ('click').

Thorough cleaning

We advise you to clean the shaving heads thoroughly once a month or when the shaver does not shave as well as it used to.

- 1** Switch off the shaver.
- 2** Pull the shaving head holder off the bottom part of the shaving unit.



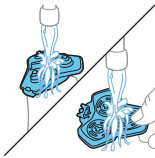

- 3** Rinse the hair chamber and shaving head holder under the tap.

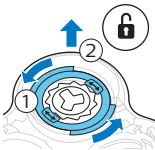

- 4** Turn the retaining ring anticlockwise and lift it off the shaving head. Repeat this process for the other retaining rings. Place them aside in a safe place.

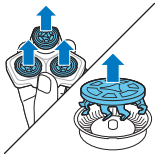

- 5** Remove the shaving heads from the shaving head holder. Each shaving head consists of a cutter and guard.

Note: Do not clean more than one cutter and guard at a time, since they are all matching sets. If you accidentally put a cutter in the wrong shaving guard, it may take several weeks before optimal shaving performance is restored.

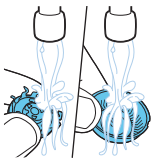

- 6** Clean the cutter and guard under the tap.
7 Shake off excess water.
8 Put the cutter back into the guard.

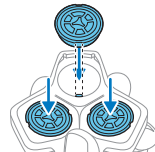

- 9** Place the shaving heads in the shaving head holder.

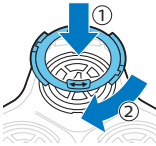

10 Place the retaining ring on the shaving head.



11 Align the arrows on the retaining ring with the projections in the shaving head holder. Turn the ring clockwise until it clicks to indicate that the ring is fixed.



12 Attach the shaving head holder to the bottom part of the shaving unit ('click').

Cleaning the trimmer attachment

Never dry the trimmer with a towel or tissue, as this may damage the trimming teeth.

Clean the trimmer attachment after each use.

- 1** Switch on the appliance with the precision trimmer attachment attached.
- 2** Rinse the attachment under a warm tap.
- 3** After cleaning, switch off the appliance.
- 4** Carefully shake off excess water and let the attachment air-dry completely.

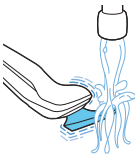

Tip: For optimal performance, lubricate the teeth of the attachment with a drop of sewing machine oil regularly.

Replacement

Replacing the shaving heads

For maximum shaving performance, we advise you to replace the shaving heads every two years. Replace

damaged shaving heads immediately.

Always replace the shaving heads with original Philips shaving heads (see 'Ordering accessories').

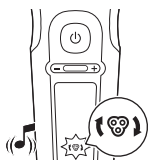

Replacement reminder

The replacement reminder indicates that the shaving heads need to be replaced. The shaving unit symbol lights up continuously, the arrows flash white and you hear a beep when you switch the shaver on or off.

- 1 Switch off the shaver. Pull the shaving head holder off the bottom part of the shaving unit.



- 2 Discard the old shaving head holder and attach the new shaving head holder to the bottom part of the shaving unit ('click').

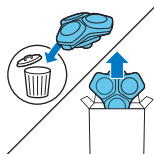

- 3 After replacing the shaving heads, you can reset the replacement reminder by pressing the on/off button for 7 seconds. Wait until you hear 3 beeps. If you do not reset the replacement reminder, the shaver resets automatically after 9 shaves.

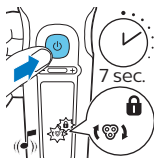

Storage



Store the shaver in the pouch.

Note: Always let the shaver dry completely before you store it in the pouch.

Ordering accessories

To buy accessories or spare parts, visit www.philips.com/parts-and-accessories or go to your Philips dealer. You can also contact the Philips Consumer Care Center in your country (see the international warranty leaflet for contact details).

The following accessories and spare parts are available:

- SH91 Philips shaving heads
- HQ110 Philips shaving head cleaning spray
- RQ111 Philips beard styler attachment
- RQ585 Philips cleansing brush attachment
- RQ560 Philips cleansing brush attachment
- RQ563 Philips cleansing brush attachment 3-pack
- HQ8505 supply unit

Note: The availability of the accessories may differ by country.

Recycling



- This symbol means that electrical products and batteries shall not be disposed of with normal household waste.
- Follow your country's rules for the separate collection of electrical products and batteries.

Removal of built-in rechargeable battery

The built-in rechargeable battery must only be removed by a qualified professional when the appliance is discarded. Before removing the battery, make sure that the appliance is disconnected from the wall socket and that the battery is completely empty.

Take any necessary safety precautions when you handle tools to open the appliance and when you dispose of the rechargeable battery.

When you handle batteries, make sure that your hands, the product and the batteries are dry.

To avoid accidental short-circuiting of batteries after removal, do not let battery terminals come into contact with metal objects (e.g. coins, hairpins, rings). Do not wrap batteries in aluminum foil. Tape battery terminals or put batteries in a plastic bag before you discard them.

Removing the rechargeable shaver battery

Only remove the rechargeable battery when you discard the shaver. Before you remove the battery, make sure that the shaver is disconnected from the wall socket and that the battery is completely empty.

Take any necessary safety precautions when you handle tools to open the shaver and when you dispose of the rechargeable battery.

1 Remove the click-on attachment from the appliance.



2 On top of the appliance insert a screwdriver between the black cylinder and silver ring. Force the silver ring up off the appliance and remove the top panel.

3 Unscrew the two screws and remove the frame.

4 Remove the two back black covers and slide the front housing off the appliance.

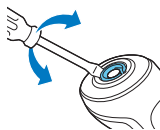

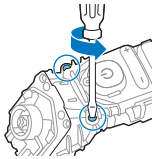

- 5 Unscrew the two screws at the top of the inner panel.

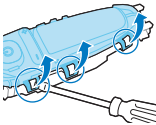

- 6 Place a screwdriver between the lips of the inner panel and bend them aside. Then remove the inner panel.

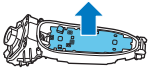

- 7 Lift out the printed circuit board with the rechargeable battery.

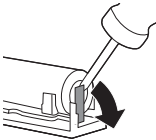

- 8 Bend the battery tags aside with a screwdriver.
9 Remove the rechargeable battery.

Support

For all product support such as frequently asked questions, please visit www.philips.com/support.

Troubleshooting

This chapter summarizes the most common problems you could encounter with the appliance. If you are unable to solve the problem with the information below, visit www.philips.com/support for a list of frequently asked questions or contact the Consumer Care Center in your country.

Shaver

Problem	Possible cause	Solution
The appliance does not work when I press the on/off button.	The rechargeable battery is empty.	Recharge the battery (see 'Charging').
	The travel lock is activated.	Press the on/off button for 3 seconds to deactivate the travel lock.
	The shaving unit is soiled or damaged to such an extent that the motor cannot run.	Clean the shaving heads thoroughly or replace them.
The appliance does not shave as well as it used to.	The shaving heads are damaged or worn.	Replace the shaving heads (see 'Replacement').
	Hairs or dirt obstruct the shaving heads.	Clean the shaving heads in the regular way or clean them thoroughly.
I replaced the shaving heads, but the display still shows the replacement reminder.	You have not reset the appliance.	Reset the appliance by pressing the on/off button for approx. 7 seconds.
A shaving unit symbol has suddenly appeared on the display.	This symbol reminds you to replace the shaving heads.	Replace the shaving heads (see 'Replacement').
The notification symbol flashes and the shaver beeps while the shaver is charging.	The appliance is overheated.	When this happens, the shaver stops charging automatically. Charging continues once the temperature of the shaver has decreased to the normal level after approx. 10 minutes.

Problem	Possible cause	Solution
The notification symbol flashes and the shaver beeps when I try to shave.	The shaving heads are soiled.	Clean the shaving heads (see 'Cleaning and maintenance').
The notification symbol flashes and the shaver beeps after cleaning the shaving heads.	The shaving heads are damaged.	Replace the shaving heads (see 'Replacement').
Water is leaking from the bottom of the appliance.	During cleaning, water may collect between the inner body and the outer shell of the appliance.	This is normal and not dangerous because all electronics are enclosed in a sealed power unit inside the appliance.

介绍

感谢您的惠顾，很高兴您选择飞利浦！为了让您能充分享受飞利浦提供的支持，请在 www.philips.com/welcome 上注册您的产品。

请阅读本用户手册，手册包含有关此剃须刀各种功能的信息以及一些使用技巧，让您的剃须体验更轻松更舒适。

基本说明（图 1）

- 1 卡入式准确修剪器附件
- 2 剃须刀头部件及胡茬储藏室
- 3 开/关按钮
- 4 个人舒适度设置提高按钮
- 5 个人舒适度设置降低按钮
- 6 个人舒适度设置栏
- 7 电池充电百分比
- 8 电池充电指示灯
- 9 通知符号
- 10 清洗提示
- 11 刀头更换提醒
- 12 “不要接电源使用”指示灯
- 13 旅行锁指示灯
- 14 存储袋
- 15 小插头
- 16 电源部件

重要安全信息

使用本产品及其附件之前，请仔细阅读本重要信息，并妥善保管以供日后参考。随附的附件可能因产品而异。

仅可将本产品用于预期用途。使用本产品及其电池和附件之前，请仔细阅读本重要信息，并妥善保管以供日后参考。误用可能会导致危害或严重伤害。随附的附件可能因产品而异。

警告



- 保持电源部件干燥。
- 警告符号注释：禁止在打开的水龙头下进行清洗。
- 该剃须刀具有防水性能。适合在沐浴或淋浴时使用，也可以放在水龙头下清洗。出于安全原因，该剃须刀在使用时不能连接电线。
- 符号注释：适合于在洗澡或淋浴时使用。允许在盛水的浴缸、淋浴、洗脸盆或其他器皿附近使用本器具。
- 请勿改装电源部件。

- 本产品也可以由 8 岁或以上年龄的儿童以及肢体不健全、感觉或精神上有障碍或缺乏相关经验和知识的人士使用，但前提是有人对他们使用本产品进行监督或指导，以确保他们安全使用，并且让他们明白相关的危害。切勿让儿童玩弄本产品。不要让儿童在无人监督的情况下对本产品进行清洁和保养。
- 用水清洁产品前，请先将电源插头拔掉。
- 请勿使用已经损坏的产品。请用新的飞利浦部件更换损坏的部件。
- 请勿在包含电动空气清新器的墙壁插座上或其周围使用电源部件，以免电源部件受到不可修复的损坏。
- 出于卫生考虑，仅能由一个人使用本产品。
- 请仅使用冷水或温水清洁产品。
- 切勿使用压缩气体、钢丝绒、研磨性清洁剂或腐蚀性液体清洁设备。
- 冲洗剃须刀时，水可能从产品底部的插口漏出。这是正常的，而且没有危险，因为所有电子元件都封闭在剃须刀内部的密封电源部件中。
- 请仅使用飞利浦原装附件或消耗品。请仅使用可拆卸电源部件 HQ8505。
- 充电、使用和存放本产品的温度应介于 5 ° C 至 35 ° C 之间。

- 请将产品和电池远离火源，切勿将其暴露于阳光直射处或高温下。
- 如果产品异常发热或发出异味、变色或充电时间比平时长，请停止使用并停止为其充电，并联系飞利浦。
- 切勿将产品及其电池放置在微波炉中或电磁炉上。
- 为防止电池发热或释放有毒有害物质，切勿打开、改装、刺穿、损坏或拆卸产品或电池。切勿使电池短路、过度充电或反向充电。
- 如果电池损坏或出现泄漏，请避免与皮肤或眼睛接触。如果不慎接触，请立即用清水冲洗并就医。

电磁场 (EMF)

本 Philips 产品符合所有有关暴露于电磁场的适用标准和法规。

显示屏

注意：使用本产品前，请先取下显示屏上的任何不干胶标签或保护膜。

充电



剃须刀充电时，其电池充电指示灯呈白色闪烁。

移动剃须刀时，显示屏上会以闪烁的电池充电百分比表示电池的充电情况。

快速充电：充电大约 5 分钟后，剃须刀含有的电量足以完成一次剃须。

电池已完全充满



电池充满电后，电池充电指示灯将呈白色持续亮起。

注意： 电池充满电后，显示屏会在 15 分钟后自动关闭。

移动剃须刀时，电池充电百分比指示灯呈白色持续亮起。

电池电量不足



当电池电量即将耗尽时，电池符号将呈橙色闪烁，并且您将听到声音。此时，电池含有的电量足以完成一次剃须。

电池剩余电量



显示屏上显示的电池充电百分比表示剩余的电池电量。

个人舒适度设置

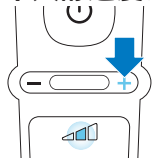

剃须刀提供进行个性化设置的功能。您可以根据个人的剃须需要，从三种设置（由低至高）中进行选择：舒适、强劲或高效。当您按下显示屏左侧或右侧的按钮时，个人舒适度设置栏格段亮起，显示选择的设置。如需选择较低或较高设置，请按下显示屏左侧或右侧按钮。

清洗提示



每次使用后请清洁剃须刀，以获得出色性能 (请参见 '清洁和保养')。关闭剃须刀时，清洗提示符号闪烁，提醒您需要清洁剃须刀。

旅行锁



您在旅行时，可以锁住剃须刀，以防止电源意外开启 (请参见 '启用旅行锁')。

更换提示



要获得更好的剃须效果，请每两年更换一次剃须刀头。剃须刀配有更换提示符号，它会提醒您更换剃须刀头。剃须刀发出提示音，更换指示灯亮起且箭头闪烁，这表示需要更换剃须刀头。

注意： 更换剃须刀头后，您需要通过按开/关按钮 7 秒来重置更换提醒。

“不要接电源使用”指示灯





“拔出插头即可使用”符号闪烁，提醒您应先断开剃须刀与电源插座的连接再打开本产品。

通知符号



过热

如果剃须刀在充电期间过热，通知符号会闪烁。在这种情况下，剃须刀会自动停止充电。在大约 10 分钟后，只要剃须刀温度降至正常水平，就会继续充电。



剃须刀头被阻塞

如果剃须刀头被阻塞，通知符号将呈红色持续亮起。更换提醒符号和清洁提醒符号会呈白色交替闪烁，并且剃须刀会发出蜂鸣音。在这种情况下，马达不会运行，因为剃须刀头太脏或已损坏。如果剃须刀头太脏，则必须进行清洁。如果剃须刀头已损坏，您必须对其进行更换。

充电

首次使用剃须刀之前，或当显示屏指示电池电量几乎耗尽时，请先为剃须刀充电。充电约需 1 小时。充满电的剃须刀剃须时间可长达 60 分钟。

注意：切勿在充电时使用剃须刀。

快速充电

剃须刀充电约 5 分钟后所含的电量足以完成一次剃须。

使用电源部件充电



- 1 确保剃须刀已关闭。
- 2 将小插头插入剃须刀，然后将电源部件插入电源插座。
剃须刀显示屏将显示剃须刀正在充电。
- 3 充电之后，从电源插座上拔下电源部件，并从剃须刀上拔下小插头。

注意：电池充满电后，显示屏会在 15 分钟后自动关闭。

使用剃须刀

使用前务必要检查剃须刀和所有配件。如果剃须刀或任何配件损坏，请勿再使用，否则可能对人体造成伤害。请务必用原装型号更换损坏的部件。



此标准表示该剃须刀可在沐浴或淋浴时使用。

符号注释：适合于在洗澡或淋浴时使用。允许在盛水的浴缸、淋浴、洗脸盆或其他器皿附近使用本器具。

- 请按照本用户手册中所述的预期家用用途使用本剃须刀。
- 出于卫生考虑，请勿共用剃须刀。
- 皮肤和毛发干燥时修剪更容易。

注意：该剃须刀具有防水性能。适合在沐浴或淋浴时使用，也可以放在水龙头下清洗。出于安全原因，该剃须刀在使用时不能连接电源线。

打开或关闭剃须刀

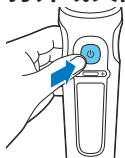

- 1 要打开剃须刀，请按一下开/关按钮。电池充电百分比指示灯亮起几秒钟。
- 2 要关闭剃须刀，请按一下开/关按钮。电池充电百分比指示灯亮起几秒钟并显示剩余电池电量。

剃须

皮肤适应期

前几次剃须可能不会带给您预期效果，并且您的皮肤可能会受到轻度刺激。这是正常的。您的皮肤和胡须需要时间适应任何新的剃须系统。为了让您的皮肤适应这款新产品，我们建议您在 3 周时间内定期（至少每周 3 次）仅使用本产品剃须。

剃须提示

如果您连续 3 天或更长时间没有剃须，为确保皮肤获得更好的舒适感，请预先修剪胡须。
选择您的个人舒适度设置 (请参见 '个人舒适度设置')。

干剃

- 1 打开剃须刀。



- 2 让剃须刀头在您的皮肤上作迂回运动，以刮剃向不同方向生长的所有须发。轻轻按压，以获取舒适贴面的剃须感受。

注意：不要用力按压剃须刀，这样做可能会导致皮肤受刺激。

- 3 每次使用后，请关闭并清洗剃须刀 (请参见 '清洁和保养')。
显示屏将亮起几秒钟时间，以显示电池剩余电量。

湿剃

要获得更舒适的剃须体验，您也可以先用剃须泡沫或剃须啫喱将脸弄湿，然后再用本产品进行剃须。

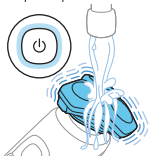

- 1 用水润湿皮肤。
- 2 在皮肤上涂抹剃须泡沫或剃须啫喱。
- 3 在水龙头下冲洗一下剃须刀头部件，确保剃须刀头部件可以在您的皮肤上顺畅滑动。
- 4 打开剃须刀。



- 5 让剃须刀头在您的皮肤上作迂回运动，以刮剃向不同方向生长的所有须发。轻轻按压，以获取舒适贴面的剃须感受。

注意：不要用力按压剃须刀，这样做可能会导致皮肤受刺激。

注意：定期冲洗剃须刀头部件，确保其能够继续在您的皮肤上顺畅滑动。

- 6 擦干面部。
- 7 每次使用后，请关闭并清洗剃须刀。

注意：确保冲净剃须刀上的所有泡沫或剃须啫喱。

使用卡入式附件

拆卸或安装卡入式附件

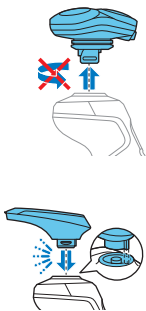

- 1 确保剃须刀已关闭。
- 2 将附件竖直抽出剃须刀。

注意：将附件从剃须刀上抽出时，不要旋转。

- 3 将附件的凸缘插入本剃须刀顶部的槽内。然后，按下附件将其安装到本剃须刀上（可听到“咔哒”一声）。

使用精确修剪器附件

您可使用修剪器附件修剪鬓角和须髥。

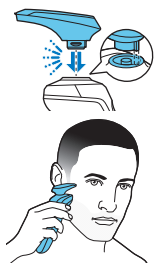

- 1 将附件安装到产品上（可听到“咔哒”一声）。
- 2 启动产品。
- 3 将修剪器垂直放在皮肤上，向下移动产品，同时轻轻按压。
- 4 使用后，请关闭本产品并清洁附件。

旅行锁

您在旅行时，可以锁住剃须刀，以防止电源意外开启。

启用旅行锁



- 1 按住开/关按钮 3 秒钟以进入旅行锁模式。
启用旅行锁后，旅行锁符号会短暂亮起且剃须刀会发出短促声音。旅行锁启用后，旅行锁符号将闪烁。
如果在旅行锁处于激活状态下尝试打开剃须刀，旅行锁符号将闪烁。

解除旅行锁



- 1 松开/关按钮 3 秒钟。
禁用旅行锁后，旅行锁符号会短暂亮起且剃须刀会发出短促声音。剃须刀打开后即可供再次使用。

注意：当连接到电源插座时，剃须刀会自动解锁。

清洁和保养

为保证更好的剃须效果，请定期清洗剃须刀。

切勿在剃须刀开启时清洗、拆除或更换剃须刀头部件。

请勿对剃须刀头网罩施加压力。

请勿使用硬物触碰剃须刀头，以免挫伤或损坏制作精密的带槽网罩。

切勿使用压缩气体、研磨剂、硬毛刷或汽油或丙酮等腐蚀性液体清洗本剃须刀。

在水龙头下冲洗剃须刀

每次剃须后请清洁剃须刀，以获得出色性能。

切记先检查水温是否太高，以防烫手。

不要用毛巾或纸巾擦拭剃须刀头部件，因为这样可能会损坏剃须刀头。

冲洗剃须刀头部件时，水可能会从剃须刀底部滴出。这属于正常现象。

- 1 打开剃须刀。
- 2 用温水冲洗剃须刀头部件。



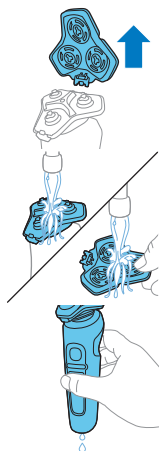

3 关闭剃须刀。将剃须刀头支架从剃须刀头部件的底部抽离。

4 在水龙头下冲洗胡茬储藏室和剃须刀头支架。

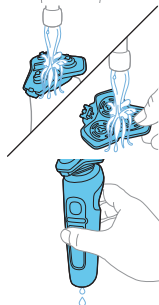

冲洗剃须刀头部件时，水可能会从剃须刀底部滴出。这属于正常现象。

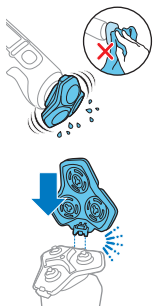

5 小心地甩掉多余水分并彻底晾干剃须刀头支架。

6 将剃须刀头支架安装到剃须刀头部件的底部（可听到“咔哒”一声）。

更换剃须刀头_简单

我们建议您每个月彻底清洁一次剃须刀头，或在剃须效果没有以前好时进行清洁。

1 关闭剃须刀。



2 将剃须刀头支架从剃须刀头部件的底部抽离。

3 在水龙头下冲洗胡茬储藏室和剃须刀头支架。

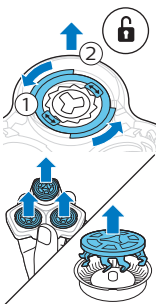

4 逆时针转动固定环，然后将它从剃须刀头中取出。
对其他固定环重复此过程。将其存放在安全的地方。

5 从剃须刀头支架上卸下剃须刀头。每个剃须刀头都包括刀片和网罩。

注意：不要同时清洁多组刀片和网罩，因为它们都是相互匹配的。如果不小心将刀片装到了错误的网罩上，则需要数周时间才能恢复产品的出色剃须性能。

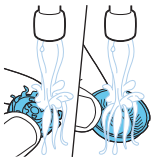

6 在水龙头下清洁刀片和网罩。

7 甩掉多余的水分。

8 将刀片重新装回至网罩。

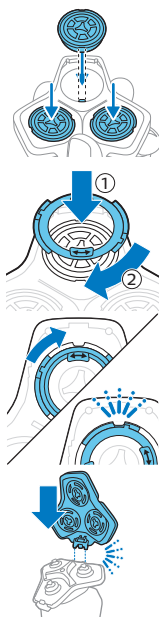

9 将剃须刀头装到剃须刀头支架中。

10 将固定环装到剃须刀头上。

11 将固定环上的箭头与剃须刀头支架上的凸起部位对齐。顺时针旋转固定环，直至听到“咔哒”一声，表明固定环已就位。

12 将剃须刀头支架安装到剃须刀头部件的底部（可听到“咔哒”一声）。

清洁修剪器附件

切勿用毛巾或纸巾擦干修剪器，否则可能会损坏修剪齿。

清洁准确修剪器附件。

- 1** 打开装有准确修剪器附件的产品。
- 2** 在温水水龙头下冲洗附件。
- 3** 清洁完成后，关闭产品。
- 4** 小心地甩干多余的水，然后将附件晾干。

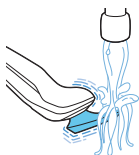

提示：为达到最佳效果，请定期用一滴缝纫机油润滑附件齿部。

更换

更换剃须刀头

为获得更好剃须效果，建议每两年更换一次剃须刀头。立即更换损坏的剃须刀头。

务必使用原装飞利浦剃须刀头 (请参见 '订购配件') 进行更换。

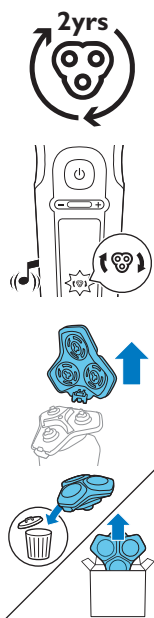

更换提示

出现更换提醒表示需要更换剃须刀头。剃须刀头部件符号持续亮起，箭头呈白色闪烁，并在打开或关闭剃须刀时听到蜂鸣音。

- 1 关闭剃须刀。将剃须刀头支架从剃须刀头部件的底部抽离。
- 2 丢弃旧的剃须刀头支架，并将新的剃须刀头支架装回剃须刀头部件的底部（可听到“咔哒”一声）。

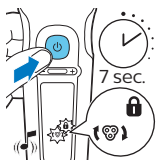

- 3 | 更换剃须刀头后，可通过按开/关按钮 7 秒来重置更换提醒。请等到听见 3 声蜂鸣音。
如果未重置更换提醒，剃须刀会在剃须 9 次后自动重置。

存放



将剃须刀存放在存储袋中。

注意：务必确保剃须刀彻底干燥，然后再将其存放在存储袋中。

订购配件

如需购买附件或备件，请访问 www.philips.com/parts-and-accessories 或联系您的飞利浦经销商。您还可以联系所在国家/地区的飞利浦客户服务中心（请参阅保修卡了解详细联系信息）。

可选配以下附件和备件：

- SH91 飞利浦剃须刀头
- HQ110 飞利浦剃须刀头清洁喷雾剂
- RQ111 飞利浦胡须造型器附件
- RQ585 飞利浦洁面刷附件
- RQ560 飞利浦洁面刷附件
- RQ563 飞利浦洁面刷附件（三件装）
- HQ8505 电源部件

注意：配件可用性可能因国家/地区而异。

产品中有害物质的名称及含量						
部件名称	有害物质					
	铅 (Pb)	汞 (Hg)	镉 (Cd)	六价铬 (Cr (VI))	多溴联苯 (PBB)	多溴二苯醚 (PBDE)
PCB's 集成电路板	X	○	○	○	○	○
Electrical contact pins 电接触片	X	○	○	○	○	○
Power plug 电源插头	X	○	○	○	○	○
Internal metal parts 内部金属件	X	○	○	○	○	○

本表格依据SJ/T 11364的规定编制。
 ○: 表示该有害物质在该部件所有均质材料中的含量均在GB/T 26572规定的限量要求以下。
 X: 表示该有害物质至少在该部件的某一均质材料中的含量超出GB/T 26572规定的限量要求。

- 该表格中所显示的“有害物质”在产品正常使用情况下不会对人身和环境产生任何伤害。
- 该表格中所显示的“有害物质”及其存在的部件向消费者和回收处理从业者提供相关物质的存在信息，有助于产品废弃时的妥善处理。

回收



- 此符号表示电器产品和电池不能与一般的生活垃圾一同弃置。
- 请遵守您所在国家/地区有关分类回收电器产品和电池的规定。

取出内置充电电池

丢弃产品时，必须仅由有资质的专业人员取出内置充电电池。取出电池之前，请确保产品与电源插座断开连接并且电池电量已完全耗尽。电池应安全地处置。

当您使用工具打开产品时以及在您弃置充电电池时，请采取必要的安全保护措施。

处理电池时，请确保您的双手、产品和电池都是干燥的。

为避免电池拆卸后发生意外短路，切勿让电池端子接触金属物体（例如硬币、发夹、戒指）。切勿用铝箔包裹电池。在丢弃之前，请用胶带将电池端子粘住或将电池放在塑料袋中。

卸下剃须刀的充电电池

必须在丢弃剃须刀前拆下充电电池。卸下电池之前，请确保剃须刀与电源插座断开连接并且电池电量已耗尽。

当您使用工具打开剃须刀时以及在您弃置充电电池时，请采取必要的安全保护措施。

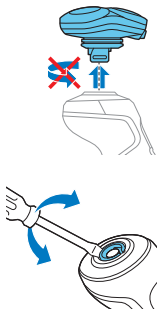

- 1 从产品中取出卡入式附件。
- 2 将螺丝刀插入本产品顶部的黑色柱体和银色圆环之间。强行将银色圆环从产品上撬起，然后卸下顶部面板。
- 3 拧下两个螺丝，然后卸下框架。

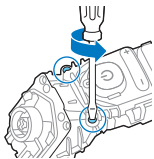

4 卸下两个黑色背盖，然后将前壳从产品上滑出。

5 拧下内侧面板顶部的两个螺丝。

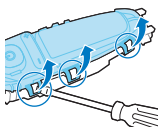

6 将螺丝刀置于内侧面板和卡舌之间，然后将卡舌向一侧弯曲。然后卸下内侧面板。

7 取出带有充电电池的印刷电路板。

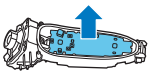

8 用螺丝刀将电池标签向外掰。

9 卸下充电电池。

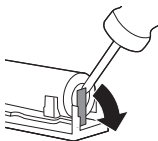

支持

有关常见问题等所有产品支持，请访问 www.philips.com/support。

故障处理方法

本章归纳了使用本产品时最常见的一些问题。如果您无法根据以下信息解决问题，请访问 www.philips.com/support 查

阅常见问题列表，或联系您所在国家/地区的客户服务中心。

剃须刀

问题	可能的原因	解决方法
按下开/关按钮时，产品不工作。	充电电池的电量已耗尽。	给电池充电 (请参见'充电')。
	旅行锁已被激活。	按住开/关按钮 3 秒钟以禁用旅行锁。
	剃须刀头部件被污染或损坏，导致马达无法运行。	彻底清洁剃须刀头或将其更换。
产品的剃须效果不如以前好。	剃须刀头已损坏或磨损。	更换剃须刀头 (请参见'更换')。
	毛发或污垢堵塞了剃须刀头。	对剃须刀头进行常规式或彻底清洁。
我更换了剃须刀头，但显示屏仍然显示更换提醒。	产品尚未重置。	按住开/关按钮大约 7 秒钟以重置产品。
显示屏上突然出现剃须刀头部件符号。	此符号提醒您更换剃须刀头。	更换剃须刀头 (请参见'更换')。

问题	可能的原因	解决方法
剃须刀充电时，通知符号闪烁且剃须刀会发出提示音。	产品过热。	在这种情况下，剃须刀会自动停止充电。在大约 10 分钟后，只要剃须刀温度降至正常水平，就会继续充电。
在我尝试进行剃须时，通知符号闪烁且剃须刀会发出提示音。	剃须刀头被污染。	清洁剃须刀头 (请参见 '清洁和保养')。
清洁剃须刀头后，通知符号会闪烁且剃须刀会发出提示音。	剃须刀头已损坏。	更换剃须刀头 (请参见 '更换')。
水从产品底部漏出。	在清洁过程中，水可能聚集在产品的机身内部与外壳之间。	这是正常现象，而且没有危险，因为所有电子元件都封闭在产品内部的密封电源部件中。

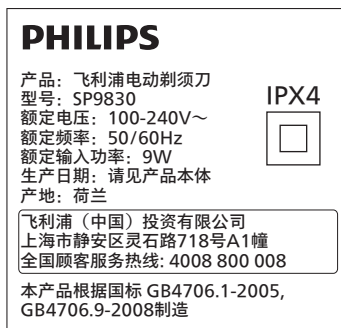

保留备用

发行日期: 21/03/2022

- 该表格中所显示的“有害物质”在产品正常使用情况下不会对人身和环境产生任何伤害。
- 该表格中所显示的“有害物质”及其存在的部件向消费者和回收处理从业者提供相关物质的存在信息，有助于产品废弃时的妥善处理。

— |

| —

— |

| —

© 2022 Koninklijke Philips N.V.

All rights reserved

保留所有权利

3000.088.9892.1 (21/03/2022)

> 75% 循环再造纸

保留备用



>75 % recycled paper
>75 % papier recyclé