

Specifications

Product name	Smart drying rack SDR601
Product model	SDR601-FA0, SDR601-FB0
Dimensions of product (LxWxH)	2,200x513x194 mm
Dimensions of host (LxWxH)	1,174x358x75 mm
Dimensions of installation template (LxW)	1,040x280 mm
Rod length	2.2 m
Lifting range	0-1100 mm
Input voltage	110-130 V 60 Hz
Rated power of product	88 W
Rated power of DC motor	50 W
Rated power of LED lamp	18 W
Rated power of UVC lamp	7 W*2
Load capacity	35 kg
Operating temperature	-15°C - +43°C
Operating humidity	10 - 90% RH, (Non-condensing)
Noise	<55 dB SPL
Quality standard	QB/T 5202-2017

Packing list

No.	Item	Qty	Unit	No.	Item	Qty	Unit
1	Host	1	pc	8	Joint bar	2	pcs
2	Scissor frame assembly	2	set	9	Cover of wire rope container	2	pcs
3	Whole rod	2	pcs	10	Set screw for scissor frame	2	pcs
4	Bed sheet rod	2	pcs	11	M8 expansion screw	4	set
5	Remote control	1	pc	12	User manual/Warranty card	1	pc
6	End cover	2	pcs	13	Installation template	1	pc
7	Joint bar accessories	2	set				

Please check carefully after unpacking. If there is any item missing, please make timely contact with Philips or Philips authorized service center.

Notices to users

反折

正折

反折

正折

- ◆ Ceiling for installation should be solid enough to have expansion screws firmly fixed.
- ◆ For your safety, please make sure the power supply is grounded and only use the power supply indicated on this product. Do not use power supply cable smaller than 0.75 mm².
- ◆ To ensure normal operation of the product, please make sure the host is installed at places away from leaking and rain.
- ◆ Do not use the product during thunderstorms.
- ◆ Do not put hands or any other objects into scissor frame when the drying rack is running up or down.
- ◆ For your health and safety, do not look directly at UVC lamps. Thanks for your cooperation.
- ◆ If batteries are not used for a long period of time, it is recommended that you remove it from remote control in case of leakage and damage. Do not mix old batteries with new ones.
- ◆ For any maintenance, do not disassemble the product by yourself. Please contact Philips or Philips authorized service centers.
- ◆ Service life of UVC lamps is 8000 hours. Actual service life may differ according to different use conditions.
- ◆ For fixing any power supply cable damage, please ask manufacturer or professionals from its designated maintenance centers for help.

Product overview

Philips SDR601 smart drying rack has two models, SDR601-FA0 with whole rods and SDR601-FB0 with adjustable rods. The picture below shows SDR601-FA0, which differs from SDR601-FB0 only in rod (item 8/item 9).

- Host
- End cover
- Scissor frame
- Wire rope
- Rod seat
- Rubber ring of clothes rod
- Flat head stainless steel self tapping screw
- Whole / adjustable rod
- Bed sheet rod
- Base of bed sheet rod
- Joint bar
- Cover of bed sheet rod

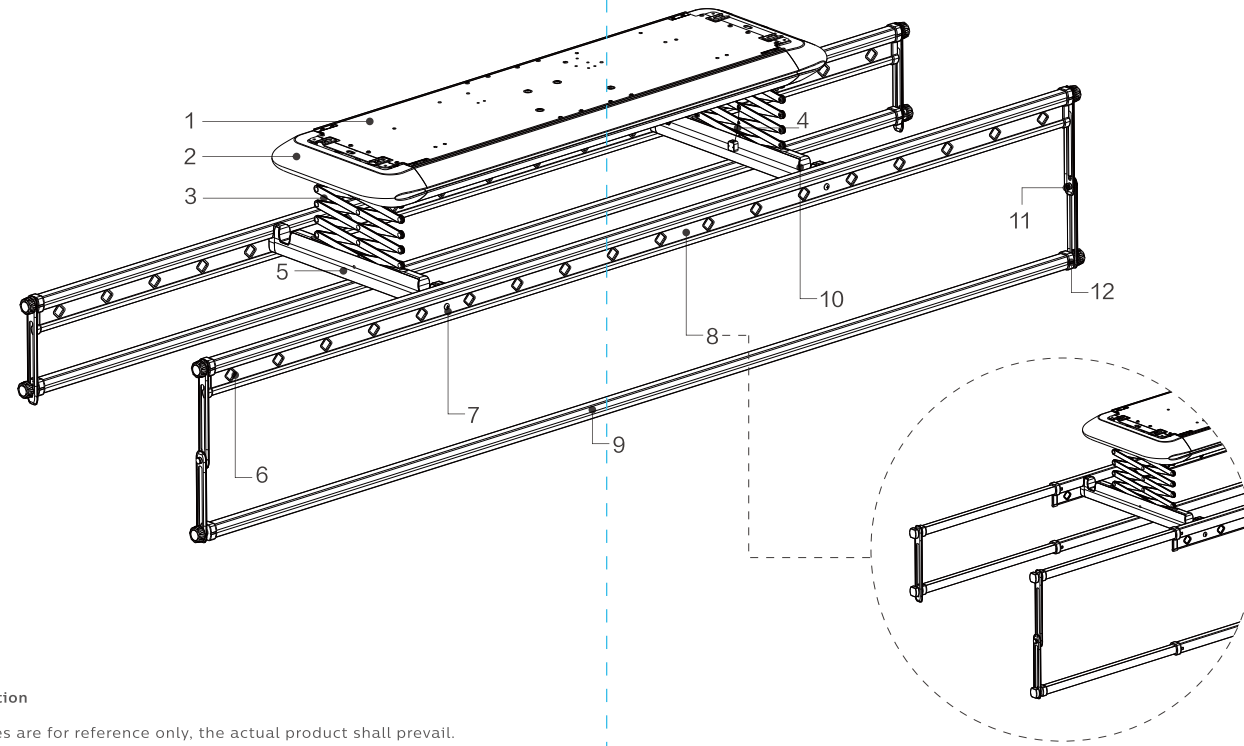

The pictures are for reference only, the actual product shall prevail.

Remote control instructions

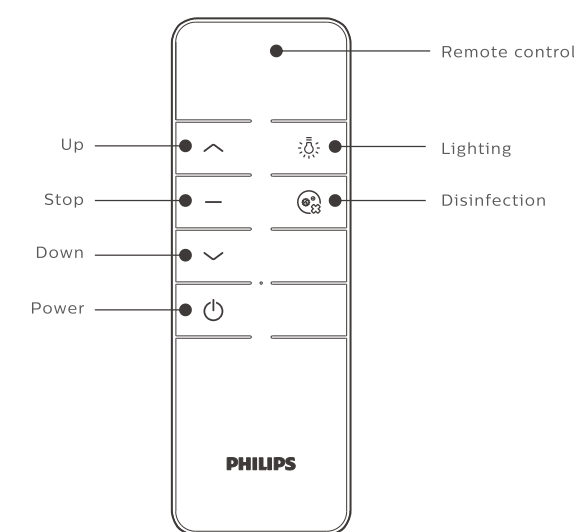

Up	Press to lift the drying rack. The rack will stop automatically at top (upper limit).
Stop	Press to stop the rising or descending drying rack.
Down	Press to lower the drying rack. The rack will automatically stop at bottom (lower limit).
Power	Power up the drying rack or cut power off.
Lighting	Press to turn on LED lamp. Press again to turn it off. LED lamp will turn off automatically after 2 hours if not being turned off manually.
Disinfection	<ul style="list-style-type: none"> ◆ Instant disinfection: press and the drying rack will rise to the top and start disinfection. Press again to stop disinfection. Disinfection process will stop automatically after 37.5 minutes if not being stopped manually. ◆ Delayed-start disinfection: press the button for more than 5 seconds. A long beep indicates the delayed-start disinfection mode is successfully turned on. The drying rack automatically rises to top and will start disinfection after 8 hours. Disinfection process will stop automatically after 37.5 minutes if not being stopped manually. ◆ Press "Disinfection" or "Down" to turn off disinfection or delayed-start disinfection function.



Kind reminder:

This user manual is used as a guide. The photos, pictures, or illustrations provided in the manual are for explanation purposes, which may differ from the specific product, please refer to the actual product. Due to product version upgrade or other needs, Philips may update this manual timely without notice. If you need the latest version of the manual, please download it from the Philips website (www.philips.com/sup-port). The copyright of any part from this manual, including text, pictures or illustrations, belongs to Philips. Without written permission, no corporation or individual may extract, copy, translate, or modify all or part of this manual in any way. Unless otherwise agreed, Philips does not make any express or implied representations and guarantees.

Shenzhen Yunyue Intelligent Technology Co., Ltd.

Address: 11th Floor, Block B, Tsinghua Info Port, No. 1 Xindong Road, Songgongshan, Songgongshan Community, Xili Street, Nanshan District, Shenzhen

Philips and the Philips Shield Emblem are registered trademarks of Koninklijke Philips N.V. and are used under license.

This product has been manufactured by and is sold under the responsibility of Shenzhen Yunyue Intelligent Technology Co., Ltd. and Shenzhen Yunyue Intelligent Technology Co., Ltd. is the warrantor in relation to this product.

To register the product(s) and get help from below site: www.philips.com/-support.

正折

反折

正折

反折

Installation instructions

Pre-install instructions

1. Please prepare the following tools before installation, including cutting pliers, hammer, Philips screwdriver, 10-14# wrench, utility knife, tape measure, insulating gloves, insulating tape, marker, etc.
2. Choose a proper location for installing the drying rack and decide the direction of host.

Fix expansion screws

1. If the chosen location is installed with lamp, turn it off and remove it first.
2. Measure dimension and mark the location for installation on ceiling.
3. As shown in Figure 1, stick installation template on marked location on ceiling, and mark out four holes.
4. As shown in Figure 2, drill 4 φ10×80 mm holes, fix and tighten expansion screws with a wrench. Loosen nuts of two expansion screws at one side and keep about 5 mm distance between washer and nut. Remove nuts and washers of 2 expansion screws on the other side.



Figure 1

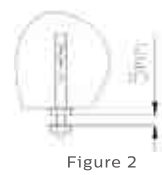

Figure 2

Install host

1. As shown in Figure 3, carefully hold the host and fix it with expansion screws, washers and fasten nuts.
2. Connect power cables correctly. (Note: connect brown wire of host power cable to live wire, blue to neutral wire, yellow and green to grounding wire), then wrap the connected wires with insulating tape and put it in the gap between host and the ceiling.

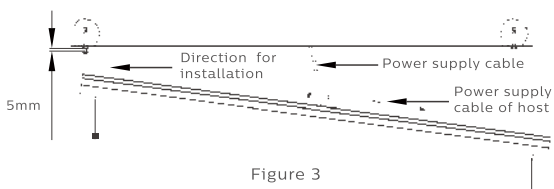

Figure 3

Install scissor frame

1. As shown in Figure 4, buckle pulley of scissor frame into the chute of mounting plate and lock it with screws.

2. As shown in Figure 5, pass the wire rope through positioning ring, then place the end part of wire rope in retainer and lock it with retainer cover.

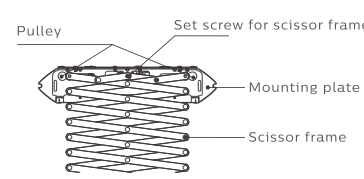

Figure 4

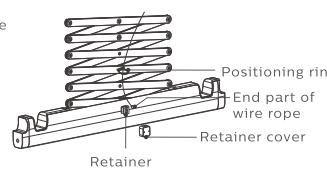

Figure 5

Install clothes rod and bed sheet rod

1. As shown in Figure 6, remove screws from rod seat, align positioning holes on rod with rod seat, then fix with screws.
2. As shown in Figure 7 (SDR601-FA0 on the left, SDR601-FB0 on the right), unfasten end cover assembly of rods and mount each part in following order, screw plug, rod cover (clothes rod, bed sheet rod or adjustable rod), joint bar and fasten all with screw plug cap.

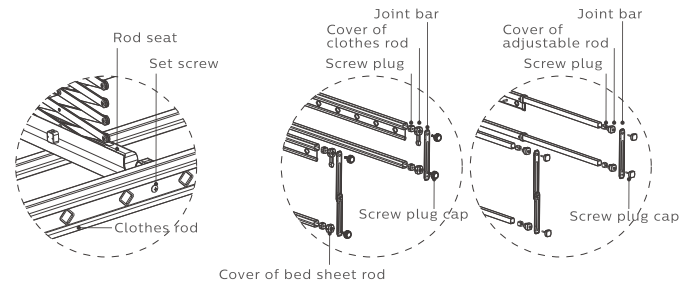

Figure 6

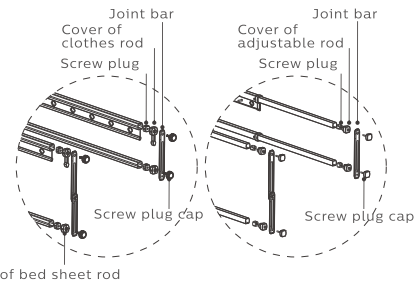

Figure 7

3. As shown in Figure 8, take bed sheet rod down when you need to dry bed sheet.
4. As shown in Figure 9, when the bed sheet rod is not needed, it can be folded and put back to rod seat.

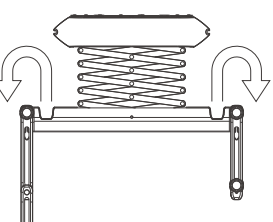

Figure 8

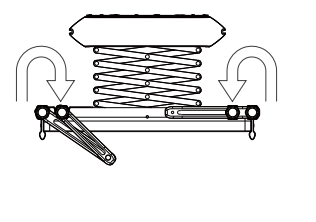

Figure 9

Remote control programming instruction

- ◆ Program the remote control before use it.
- ◆ Programming: unplug host power and replug it after 10 seconds, after which there will be a long beep. Following the beep, press "Up" and "Down" simultaneously and there will be 3 continuous beeps, indicating successful programming.
- ◆ Delete single code: unplug host power and replug it after 10 seconds, after which there will be a long beep. Following the beep, press "Down" and "Stop" simultaneously and there will be 3 continuous beeps, indicating the code has been deleted successfully.
- ◆ Delete all codes: unplug host power and replug it after 10 seconds, after which there will be a long beep. 10 seconds within the beep, press "P2" after which there will be 3 continuous beeps. Press "Stop" and there will be another 3 beeps indicating all codes of the remote control have been successfully deleted.

⚠ Attention: the "P2" button is inside battery box of the remote control. Remove battery cover to use it.

Function test instructions

- ◆ Down: press "Down" and observe whether the drying rack stops running automatically after it descends about 1.1m.
- ◆ Up: press "Up" and observe whether the rack stops running automatically after it reaches to the top.
- ◆ Lighting: press "Lighting" and observe whether the LED lamp can turn on and off normally.
- ◆ Disinfection: press "Disinfection" and observe whether the UVC lamps work normally.
- ◆ Soft push to lift: push rod or rod seat of the drying rack with your hand, then let go and see whether the drying rack will rise.
- ◆ Hold to stop: when the drying rack is descending, hold up the rod or rod seat of the drying rack to observe whether it stops immediately.

Troubleshooting

Failure	Possible reasons	How to solve
Remote control does not work	The host is not powered; low battery power; remote control is not programmed.	Power up host; replace batteries of remote control; re-program remote control
Drying rack stops suddenly during running	Drying rack encounters resistance and triggers switch; motor's self-protection from overheating.	Remove objects causing resistance; wait for motor to cool down before start it again
LED lamp doesn't work	The host is not powered; LED lamp is damaged.	Power up the host; replace LED lamp.

Warranty card

Relevant information	
User name	Contact of user
Address of user	
Name of product	Model of product
Serial number of product	Invoice No.
Seller	Date of sales
Seller address	

Maintenance records			
Date	Issue	Maintenance staff	User signature

After-sales service policy

Warranty policy

1. Warranty starts from the date of purchase as per receipt or date of sales on warranty card.
2. Warranty period: 3-year for the product and 5-year for motor.

Warranty exceptions

The following scenarios are not covered by this warranty and paid services are available:

1. Warranty period has expired;
2. Damage caused by unauthorized maintenance, misuse, collision, negligence, abuse, liquid ingress, accidents, refitting, using accessories that doesn't come with the product, tearing or altering of labels and anti-counterfeiting marks;
3. Product failure or damage caused by installation, use, maintenance, and storage that against the instructions of this user manual;
4. Damage caused by force majeure.

PHILIPS

6000 Series

Smart drying rack

SDR601



User manual

Please read this user manual carefully before using this product.

Thank you for purchasing Philips-branded products. For your safety, please read this user manual carefully before using the product. Any personal injury, property or other loss caused by not following the user manual or precautions, no liability will be assumed by Philips.

PHILIPS		比例	1:1
名称	飞利浦SDR601智能晾衣架 用户手册	尺寸	100*200mm (成型)
		颜色	黑色(COMOYK90)
日期	20210413	材料	105g双铜纸
		设计	邱文静