

If you have any questions or need a detailed manual, please visit our support website at

32PFL3508

- Si tiene cualquier pregunta o necesita un manual detallado, por favor visite nuestro sitio web de soporte en
- Si vous avez des questions ou avez besoin d'un manuel détaillé, veuillez visiter notre site de soutien au

www.philips.com/support

Quick Start

ES Inicio Rápido FR Démarrage Rapide

1. What's in the box ES Qué hay en la caja FR Contenu de la boîte

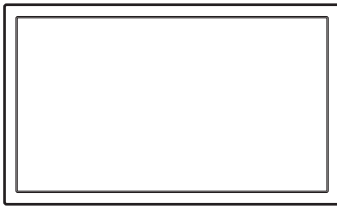

M4 x 0.551" (14mm)

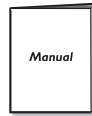

- manual, inicio rápido
- manuel, démarrage rapide

PHILIPS

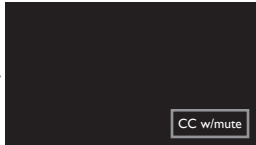
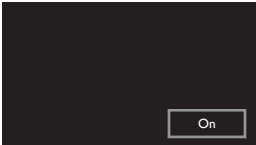
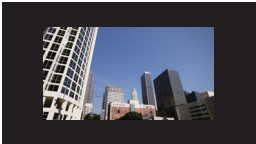
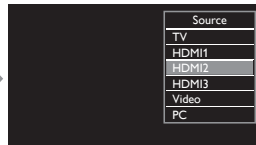
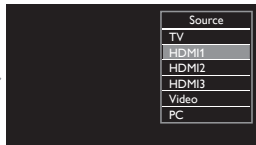
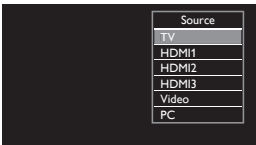
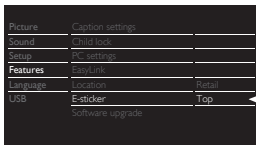
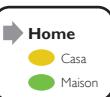
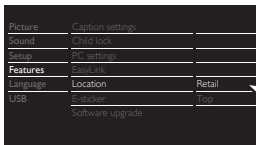
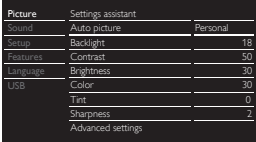
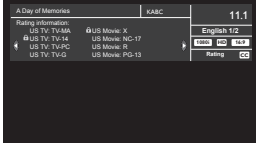
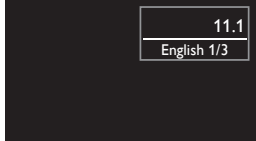
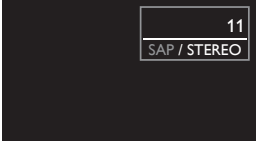
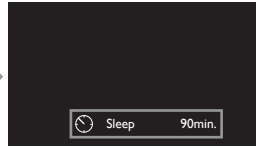
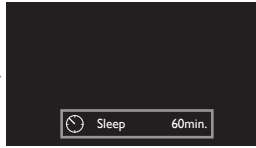
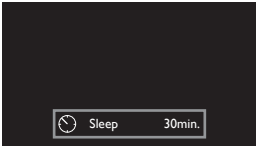

8. Using the remote control

ES Uso del mando a distancia

FR Utilisez la télécommande



SLEEP

Sets sleep timer.

ES Ajusta el temporizador de apagado automático.

FR Règle le minuteur de mise en veille.

SAP

Selects Audio mode (MONO/STEREO/SAP)/Audio language.

ES Selecciona el modo de Audio (MONO/ESTÉRÉO/SAP)/Idioma de audio.

FR Sélectionne le mode audio (MONO/STÉRÉO/SAP) / la langue audio.

INFO

Displays information about the current program.

ES Muestra información sobre el programa actual.

FR Affiche les renseignements sur l'émission en cours.

HOME (MENU button) **ES** boton de MENU **FR** bouton de MENU

Opens the main on-screen menu.

ES Abre el menú principal en pantalla.

FR Ouvre le menu principal à l'écran.

To turn Off the E-sticker feature

ES Para desactivar la característica Pegatina elect.

FR Coupure de l'Étiquette E



SOURCE

Selects connected devices.

ES Selecciona los dispositivos conectados.

FR Sélectionne les appareils connectés.

FORMAT

Adjusts the picture size on the TV screen.

ES Ajusta el tamaño de imagen en la pantalla de televisión.

FR Règle la taille de l'image sur l'écran du téléviseur.

CC

Displays the audio portion of programming as text superimposed over the video.

ES Muestra la parte del audio de la programación como texto superpuesto sobre el video.

FR Affiche la partie audio de l'émission en texte superposé sur l'image.

6. Control panel

ES Panel de control

FR Panneau de commande

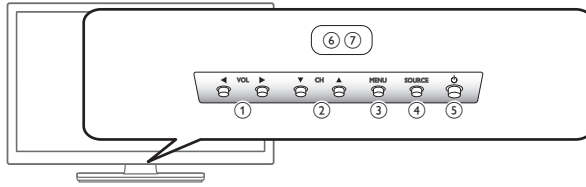

- | | | |
|---|--|--|
| <p>① Adjusts the volume</p> <p>② Selects a channel</p> <p>③ Opens the main on-screen menu</p> <p>④ Selects connected devices</p> <p>⑤ Turns the TV on and off</p> <p>* ⑥ Power On/Standby Indicator</p> <p>* ⑦ Remote Control Sensor</p> | <p>ES Ajusta el volumen</p> <p>Selecciona un canal</p> <p>Abre el menú principal en pantalla</p> <p>Selecciona los dispositivos conectados</p> <p>Enciende o apaga la televisión</p> <p>Indicador de encendido</p> <p>Sensor de Control Remoto</p> | <p>FR Règle le volume</p> <p>Sélectionne une chaîne</p> <p>Ouvre le menu principal à l'écran</p> <p>Sélectionne les appareils connectés</p> <p>Allume et éteint le téléviseur</p> <p>Voyant d'alimentation</p> <p>Capteur de la télécommande</p> |
|---|--|--|

* Built inside the panel, not visible from the surface.
 ● Integrado dentro del tablero, no visible desde la superficie. ● Construit à l'intérieur du panneau, non visible de la surface.

7. First time setup

ES Configuración inicial

FR Première configuration

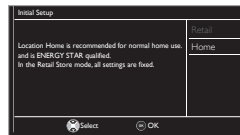
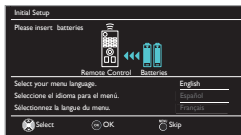

Follow the on-screen instructions to complete your TV setup.

- Siga las instrucciones en pantalla para realizar la configuración de la TV.
- Suivez les instructions apparaissant à l'écran pour terminer la configuration de votre téléviseur.

Selecting **Location to Retail** will display E-sticker (electric POP) on the screen. See "To turn Off the E-sticker feature" on the next page.

- Seleccionar **Ubicación en Tienda** mostrará una etiqueta electrónica (POP eléctrica) en la pantalla. Consulte "Para desactivar la característica Pegatina elect." en la siguiente página.
- La sélection de **Région à Magasin** affichera la vignette électronique (POP électrique) à l'écran. Voir « Coupure de l'Étiquette E » à la page suivante.

For further assistance, call the customer support service in your country.

- To obtain assistance, contact Philips Customer Care Center;

In the U.S.A., Canada, Puerto Rico, or the U.S. Virgin Islands **1 866 309 5962**

México D.F. y Área Metropolitana; **58 87 97 36**, Interior de la República; **01 800 839 19 89**

Enter below the model and serial numbers located on the back and right side of the TV cabinet.

● Para obtener más información, llame al servicio de soporte al cliente de su país.

- Para obtener asistencia, comuníquese con Centro de atención al cliente de Philips;

En los Estados Unidos, en Canadá, Puerto Rico o en las Islas Vírgenes de los Estados Unidos; **1 866 309 5962**

México D.F. y Área Metropolitana; **58 87 97 36**, Interior de la República; **01 800 839 19 89**

Escriba a continuación el modelo y número de serie que están localizados en lado derecho y parte posterior de el gabinete de el televisor.

● Pour obtenir de l'aide supplémentaire, communiquez avec le centre de service à la clientèle de votre pays.

- Pour obtenir de l'aide, communiquez avec le centre de service à la clientèle Philips au;

Dans le États-Unis, au Canada, à Puerto Rico ou aux Îles Vierges américaines; **1 866 309 5962**

México D.F. et Área Metropolitana; **58 87 97 36**, Interior de la República; **01 800 839 19 89**

Entrer ci dessous le modèle et le numéro de série situés derrière à droite sur le dos du téléviseur.

Model / Modelo / Modèle :

Serial / Serie / Série :

For complete instructions, please visit www.philips.com/support to download the full version of the User Manual.



Philips and Philips Shield are used under license of Koninklijke Philips N.V.

www.philips.com/support



* 2 E M N 0 0 1 1 1 A *



Printed in Thailand

● Imprimido en Thailand

● Imprimé en Thailand

2EMN00111A★★★★★

2. Mount base onto TV

ES Conecte la base al TV

FR Montez le socle sur le téléviseur

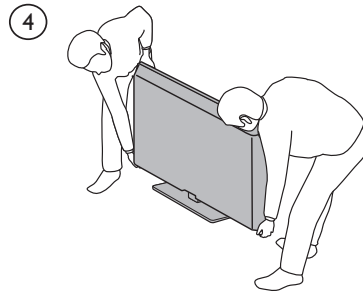
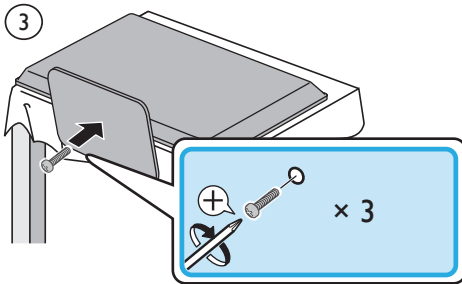
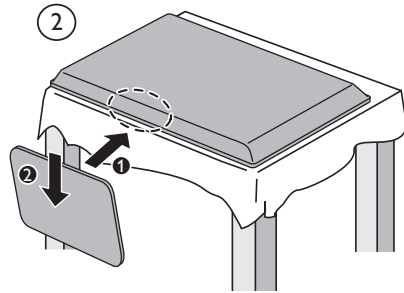
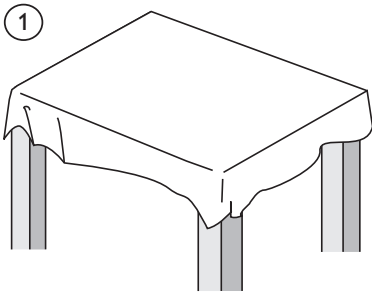

3. Connect the power and antenna or cable

ES Conecte los cables a la red eléctrica y la antena o el cable

FR Connexion de la prise secteur et de l'antenne ou du câble

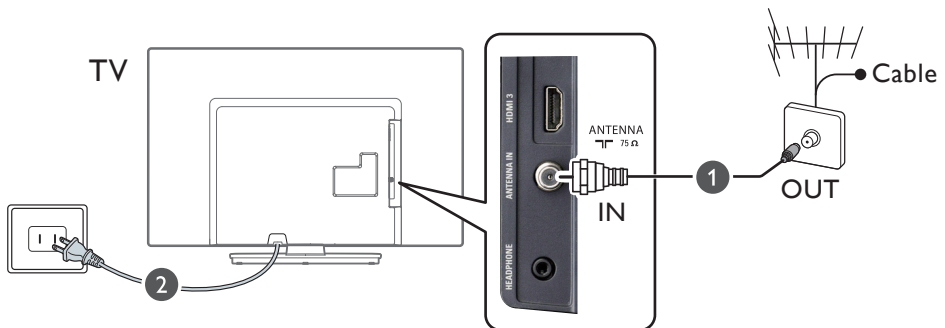

4. Connection overview ES Descripción general de las conexiones FR Présentation de la connexion

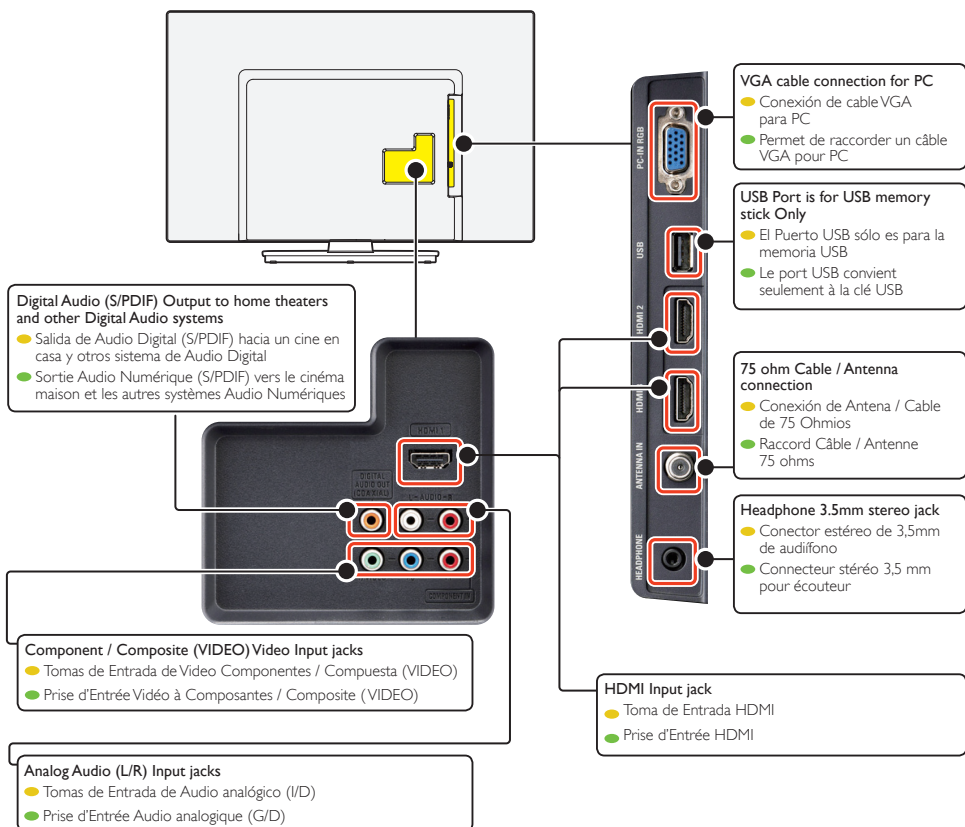

Philips continuously tries to improve its products and it wants you to benefit from that even after your purchase. Software updates may be available for your TV. Please refer to the full user manual for directions on how to complete the update or visit www.philips.com/support

- Philips continuamente intenta mejorar sus productos y desea que usted se beneficie por ello después de su compra. Pueden haber disponibles actualizaciones de software para su televisión. Por favor consulte el manual de usuario completo respecto a instrucciones sobre cómo completar la actualización o visite www.philips.com/support
- Philips tente constamment d'améliorer ses produits et souhaite que vous puissiez en profiter même après votre achat. Les mises à jour du logiciel peuvent être disponibles pour votre téléviseur. Veuillez consulter le manuel de l'utilisateur pour les instructions indiquant comment faire une mise à jour ou visitez le www.philips.com/support

5. Connect external devices

ES Conexión de dispositivo externo
FR Connexion d'un appareil externe

Best

ES Mejor
FR Meilleur

Blu-ray Disc or DVD player / home theater system / cable or satellite set-top box / gaming console / PC / digital camera / camcorder

- Disco Blu-ray o reproductor de DVD / sistema de teatro en casa / decodificador de cable o satélite / consola de videojuego / PC / cámara digital / cámara de video
- Lecteur de disques Blu-ray ou DVD / chaîne de cinéma maison / boîte numérique de câble ou de satellite / console de jeu / ordinateur personnel / appareils photo numériques / caméscope

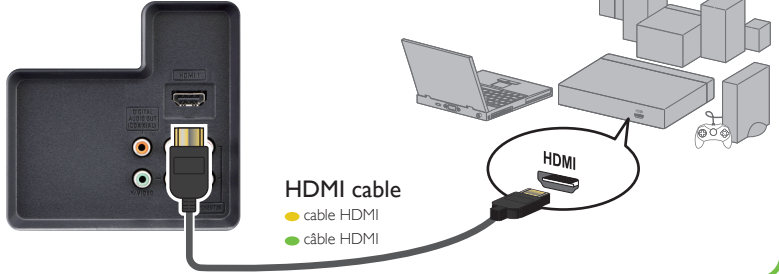

Better

ES Bien
FR Mieux

Blu-ray Disc or DVD player / home theater system / cable or satellite set-top box / gaming console

- Disco Blu-ray o reproductor de DVD / sistema de teatro en casa / decodificador de cable o satélite / consola de videojuego
- Lecteur de disques Blu-ray ou DVD / chaîne de cinéma maison / boîte numérique de câble ou de satellite / console de jeu

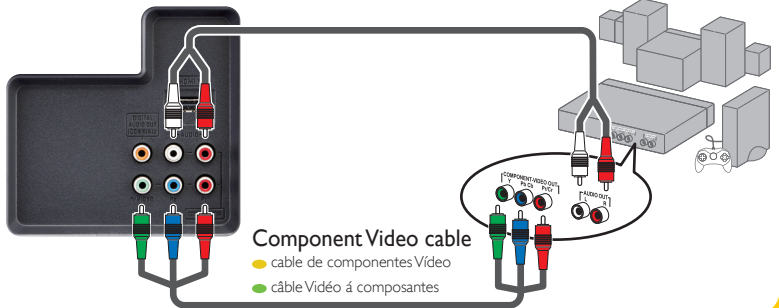

Good

ES Bueno
FR Bonne

DVD player / home theater system / cable set-top box / VCR player / video recorder / gaming console

- Reproductor de DVD / sistema de teatro en casa / decodificador de cable / reproductor de VCD / grabadora de video / consola de videojuego
- Lecteur de DVD / chaîne de cinéma maison / boîte numérique de câble ou de satellite / magnéscope / console de jeu

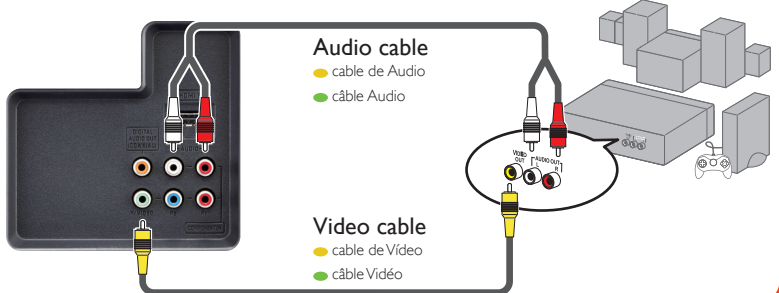



Caution Disconnect the AC power cord before connecting devices.

● **Precaución** Desconecte el cable de suministro eléctrico antes de conectar dispositivos.

● **Attention** Déconnectez le cordon d'alimentation avant de raccorder les appareils.

One set of Audio L/R Inputs are shared by Component, Composite, VGA and HDMI-DVI Video Input.

● Un juego de Entradas de Audio L/R se comparten con las Entradas de Componente, Compuesto, Video VGA o Entrada de Video HDMI-DVI.

● Un ensemble de prises d'Entrée Audio G/D avec Composant, Composite, prises d'Entrée Vidéo VGA ou Entrée Vidéo HDMI-DVI.

Headphones

- auriculares
- écouteurs



Stereo mini plug cable (3.5mm)

- cable de miniplug Audio estéreo (3,5mm)
- câble Audio stéréo à mini-jack (3,5 mm)



PC

- computadora personal
- ordinateur personnel

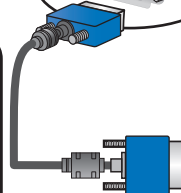

USB Memory Stick

- dispositivo de memoria USB
- clé USB



VGA cable

- cable VGA
- câble VGA

