

PHILIPS

EasyKey

9000 series

Push-pull
Smart Door Lock

9200

User manual

Register products and get
support on the following site

www.philips.com/support



Contents

1 Important Information 02

Safety
Warning
Disposal of used products
and batteries

2 EasyKey Installation 03

Packing List
Exploded Views
Pre-install Instruction
Installation Steps

3 Get to know your EasyKey 08

Outside Escutcheon
Inside Escutcheon

4 How to set up your EasyKey 09

-Pre-setup Instruction
-Modify Master PIN Code
-User Settings
-Delete a user record
-System Settings
-Extended Functions
-System Query
-Local Query
-Bluetooth Settings

5 How to use EasyKey 15

Unlock
Unlock from Outside
-With a PIN Code
-With a Fingerprint
-With a Key Tag/Card
Unlock from Inside
-With a Rotatory Knob
-With a Functional Button
-With an Infrared Sensor
Lock
-Auto/Manual Mode
-Lock from Outside
-Lock from Inside
Indoor Deadlock
Mechanical Key Opening

6 Other Functions 18

Indoor Infrared Sensor Unlock
Restore to Default Settings
Mute Button
Outside Forced Lock

7 The Use and Meanings of Indicators 20

Door Lock Status Indicator
Low Battery Voltage Indicator
Outside Forced Lock Indicator
Mute Indicator
Inside Deadlock Indicator
System Lock-up Indicator
[OPEN/CLOSE] Indicator
Indoor Infrared Sensor Unlock
Indicator

8 Troubleshooting 22

Alarm Types and Methods
How to use an Emergency Power
Supply
How to Replace Batteries

1 Important information

Safety

◆ Before using Philips EasyKey, please read and understand all instructions. Damage caused by non-compliance with the instructions will not be covered by warranty.

◆ Use only the manufacturer-specified accessories/components.

◆ Use only the alkaline batteries the product is equipped with, or use the same specification type of alkaline batteries.

◆ Do not forcibly disassemble this product to avoid triggering an alarm or damaging the product.

◆ Do not scrape the fingerprint sensor with sharp objects, otherwise it may cause permanent damage.

◆ Do not expose products to environments where there is water leakage or splashing.

◆ Do not expose the product to corrosive substances to prevent damaging the protective cover.

◆ Do not hang objects on the handle, in case it might affect the normal use of the lock.

◆ Please clean the product with a soft cloth.

◆ Do not remove the battery during setting up and operating.

◆ Please let a professional technician to install the door lock and follow the installation guidelines provided. Do not disassemble the lock by yourself. Keep the relevant sealed stickers properly. Do not easily disclose the password information.

◆ Please modify the default master PIN code immediately after finishing installing and debugging, and keep the mechanical key properly.

◆ Please replace all the batteries immediately if there is a low battery alarm. Please make sure to correctly match the poles (+/-) when installing the batteries.

Caution

◆ Do not place the battery near fire sources to avoid explosion.

◆ Do not use any emergency power supply that does not meet the safety requirements to power up the product.

◆ Do not connect the 2 poles of the batteries with metals to avoid short circuit which may lead to an explosion.

◆ Please make sure any component replacement is executed by Philips, Philips authorized service center or professional technicians.

◆ Do not use accessories or parts that have been produced by other manufacturers or have not been specifically recommended by Philips. The use of such accessories and parts may void your warranty.

Disposal of used products and batteries

◆ You can have your locks reclaimed at Philips authorized service centers. You will receive corresponding compensation if your products meet our conditions.

◆ Please familiarize yourself with the local electronic product collection system.

◆ Please follow local regulations and do not discard used products into ordinary household waste.

◆ Proper disposal of used products can help to avoid potential negative impacts on the environment and human health.

◆ Batteries must not be disposed of with ordinary household waste.

◆ Please familiarize yourself with the local regulations on batteries classification recycling. Disposing of batteries properly can help avoid a negative impact on the environment and human health.

2 Easykey Installation

Packing List

This packing list is for reference only. Please refer to the actual packing items.



Exploded Views

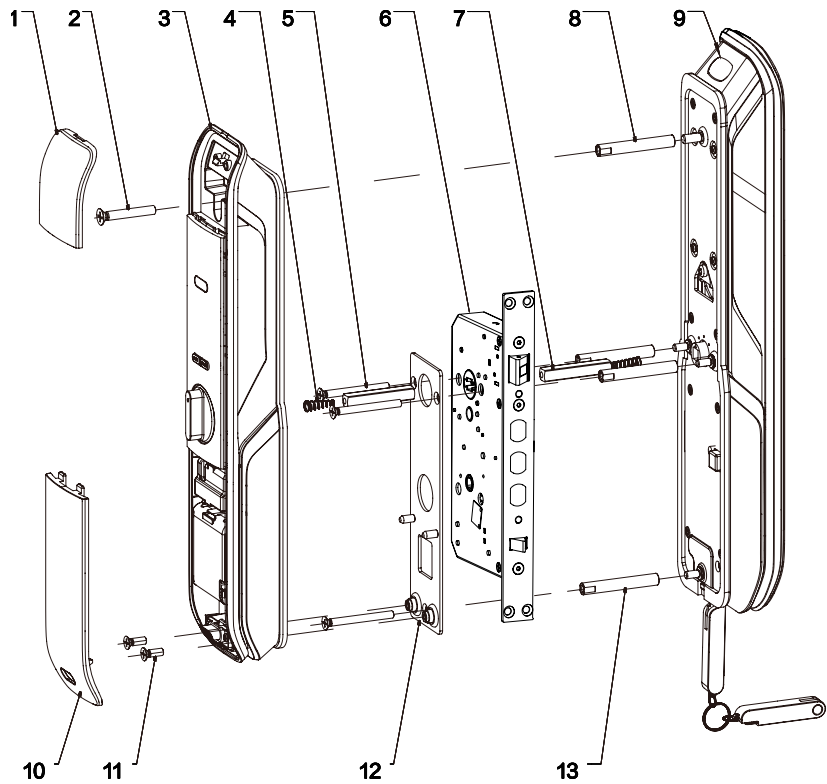

- | | | |
|---------------------------|---------------------------------|----------------------------------|
| 1. Upper deco cover(X1) | 6. Mortise (X1) | 11. M6*20 anchor screw(X2) |
| 2. M6 anchor screw(X1) | 7. Square shaft (X2) | 12. Mounting Plate (X1) |
| 3. Inside escutcheon(X1) | 8. M6 connecting screw tube(X1) | 13. M5 connecting screw tube(X3) |
| 4. Compressed spring (X2) | 9. Outside escutcheon(X1) | |
| 5. M5 anchor screw (X3) | 10. Battery cover (X1) | |

Pre-install Instruction

Step 1 | Check the door opening direction

This product can be installed on 4 types of opening directions: left-out pull, right-in push, right-out pull and left-in push

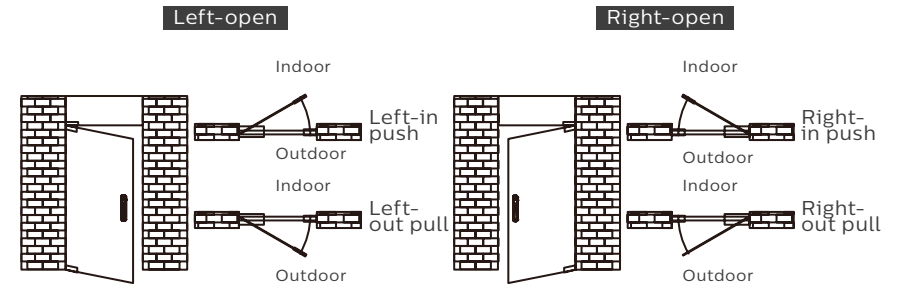

Step 2 | Latch bolt direction change

- Loosen the screws by turning them clockwise with Allen wrench and remove the mortise plate.
- Take out the latch bolt and rotate it to 180°, then put it back.

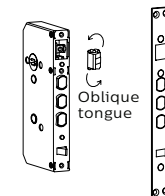
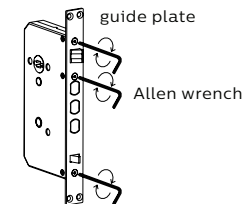

- Mount the mortise plate and fasten it with screws.

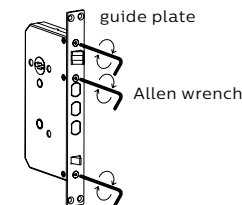

⚠ Attention

- Please choose proper installation kit as per the door thickness.
- The default installation kit is applicable for a door thickness of 38-60mm, if your door thickness does not within this range, please feel free to contact us.

Installation Steps

- 1 To drill the needed holes in the door as per the drilling template, then mount the mortise on the door frame.
- 2 Fasten the 4 anchor screws in the mortise.

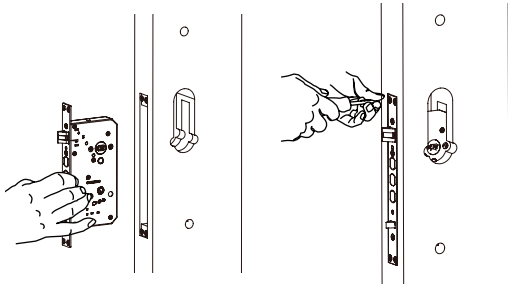

⚠ Attention

The latch bolt can't be popped up during installation.

- 3 Install the protective cover and connecting screw tubes on the outside escutcheon, and put the compressed spring and the square shaft in the square shaft hole accordingly.

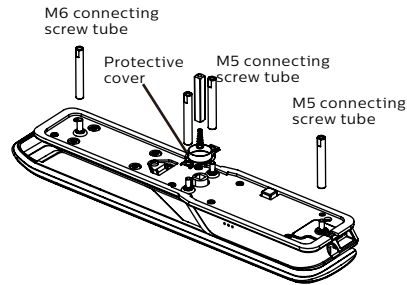

⚠ Attention

Please use the appropriate square shaft and connecting tubes with proper length.

- 4 Pass the connecting cable through the hole above the door. Align the square shaft of the outside escutcheon with the two rotary holes on the mortise, then insert the square shaft into the rotary holes, so that the outside escutcheon is close fit in the outside door.
- 5 First align the mounting plate tightly to the inner surface of the door, then fasten it with three M5 connecting screws.

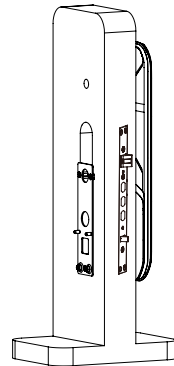
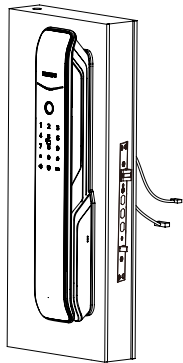

- 6 Put the compressed spring and square shaft into the square shaft hole of the inside escutcheon accordingly.

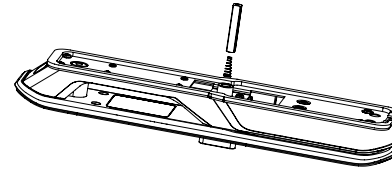

⚠ Attention

Be sure to hide the extra mortise and the escutcheon connecting cables in the door hole, and also hide the extra Bluetooth connecting cable in the inside escutcheon.

- 7 Insert the outside escutcheon connecting cable and the mortise connecting cable into the corresponding sockets on the inside escutcheon, and then align the square shaft hole on the inner escutcheon with the rotating port on the mortise and insert it, make the inner escutcheon close to the inner surface of the door.

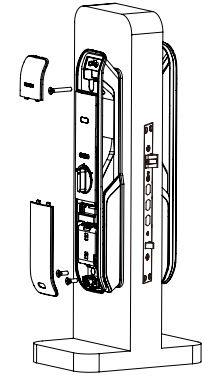

- 8 Fasten the three M6 anchor screws, and close the upper deco cover.
- 9 Install the batteries, put on the battery cover, then mount the strike to finish the installation.
- 10 Test if the push-pull handle in both inside and outside escutcheon, rotary knob, infrared handle, fingerprint sensor and mechanical key could work properly or not.

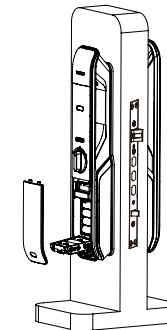
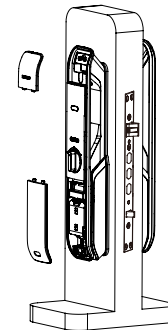

⚠ Attention

After completing the installation of the strike, please check whether the smart lock can be used normally.

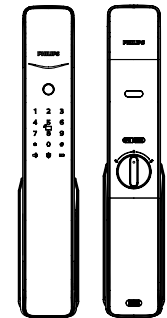

3 Get to know Your EasyKey

Outside Escutcheon

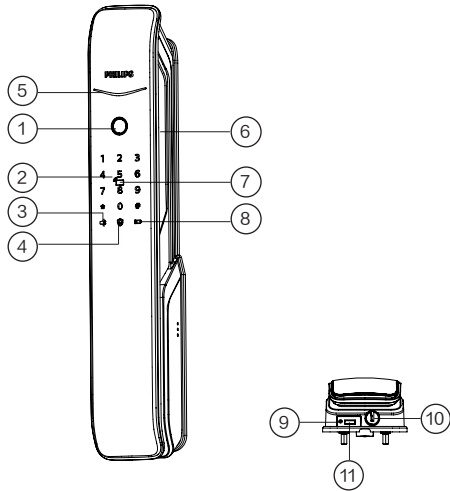

1	Fingerprint Sensor
2	Keypad
3	Mute Button
4	Outside Forced Lock Button
5	Lock Status Indicator
6	Handle
7	Card Reader
8	Low Battery Voltage Indicator
9	Reboot
10	Mechanical Key
11	Emergency power supply port

Inside Escutcheon

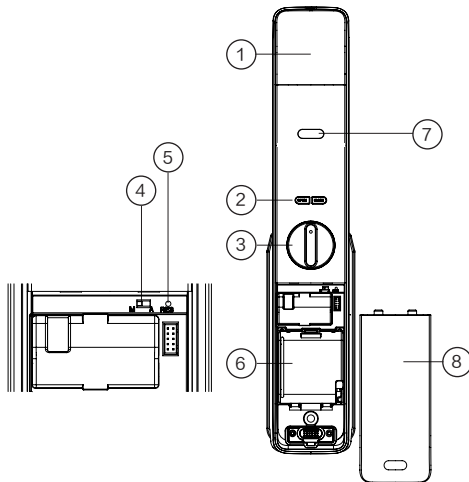

1	Upper deco cover
2	[OPEN/CLOSE]button
3	Rotary knob
4	Auto/Manual mode switch
5	Reset
6	Battery compartment
7	Infrared handle
8	Battery cover

4 How to set up your EasyKey

Pre-install Instruction

◆There are two modes for the EasyKey System: general mode and dual verification mode.

General Mode	Dual Verification Mode
Unlock with any of the registered identify methods	Unlock with any two of the registered identify methods among PIN code, Key Tag, and Fingerprint

◆User Code
When you want to delete one single user record, you could delete it in the system by deleting its user code.

◆You could fill in the below blank sheet with the user information in case you might need to check or review in the future.

Number	Name	Fingerprint	PIN Code	Card
00				
01				
02				
03				
04				
05				
06				
07				
08				
09				

◆Icon annotation

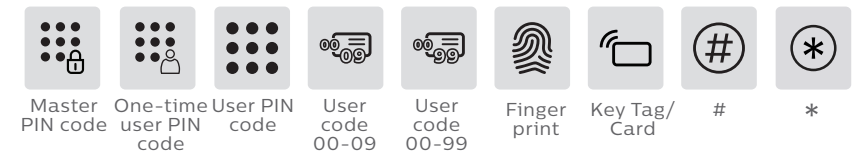

⚠ Attention

- 1.Press [*] key to return to the previous menu.
- 2.The default master PIN code is 12345678.

◆How to enter into Master Mode

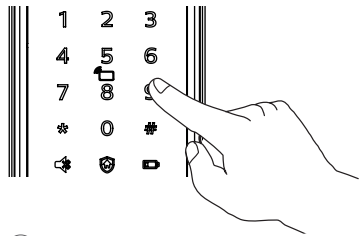
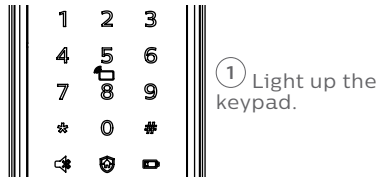

② Press [#] before inputting any other numbers. After hearing a voice prompt of "Enter master PIN code", enter your master PIN code and confirm with [#]. Then you are in master mode.

Modify master PIN code



Enter [#], enter master PIN code and confirm with [#].



Enter [1] to modify master PIN code.



Enter the new master PIN code and confirm with [#] again. Re-enter the same master PIN code and confirm with [#]. After hearing a voice prompt of "Succeeded", press [*] to return to previous menu until you finally exit master mode.

User settings

Add a user PIN code



Enter [#], then enter master PIN code and confirm with [#].



Enter [2] to add a user record, then enter [1] to add a new user PIN code, and the system will automatically number it and generate a voice prompt.



Enter a user PIN code of 6 to 12 digits and confirm with [#]. Then re-enter the user PIN code and confirm with [#]. After hearing a voice prompt of "Succeeded", press [*] until you exit master mode.

Add a one-time User PIN Code



Enter [#], enter master PIN code and confirm with [#].



Enter [2] to enter into user setting, then enter [2] again to add a one-time user PIN code.



Enter a one-time user PIN code of 6 to 12 digits and confirm with [#]. Then re-enter the one-time user PIN code and confirm with [#]. After hearing a voice prompt of "Succeeded", press [*] until you exit master mode.

Add a Fingerprint



Enter [#], enter master PIN code and confirm with [#].



Enter [2] to add a user record, then enter [3] to add a user fingerprint, and the system will automatically number it and generate a voice prompt.



Place your finger against the sensor. After hearing a voice prompt of "Take away your finger and enroll again", please take away your finger and re-place it against the sensor. After hearing a voice prompt of "Succeeded", press [*] until you exit master mode.

Add a Key Tag



Enter [#], enter master PIN code and confirm with [#].



Enter [2] to add a user record, then enter [4] to add a user key tag, and the system will automatically number it and generate a voice prompt.



Place the key tag against the card reader until you hear a beep. After hearing a voice prompt of "Succeeded", press [*] until you exit the master mode.

Delete a User Record

Delete a single User PIN Code



Enter [#], enter master PIN code and confirm with [#].



Enter [3] to delete a user record, then enter [1] to delete a user PIN code, and then enter [1] to delete a single user PIN code.



Enter a user code (code: 00-09) of 2 digits and confirm with [#]. After hearing a voice prompt of "Succeeded", press [*] until you exit the master mode.

Delete All User PIN Codes



Enter [#], enter master PIN code and confirm with [#].



Enter [3] to delete a user record, then enter [1] to delete a user PIN code, and then enter [2] to delete all user PIN codes. After hearing a voice prompt of "Succeeded", press [*] until you exit the master mode.

Delete all One-time PIN Codes



Enter [#], enter master PIN code and confirm with [#].



Enter [3] to delete a user record, then enter [2] to delete all one-time user PIN code.



After hearing a voice prompt of "Succeeded", press [*] until you exit the master mode.

Delete a Fingerprint



Enter [#], enter master PIN code and confirm with [#].



Enter [3] to delete a user record, then enter [3] to delete fingerprint record, and then enter [1] to delete one single fingerprint record.



Enter the 2-digit [user number] (00-99) of the fingerprint that is to be deleted and confirm with [#]. After hearing a voice prompt of "Succeeded", press [*] until you exit the master mode.

Delete All Fingerprints



Enter [#], enter master PIN code and confirm with [#].



Enter [3] to delete a user record, then enter [3] to delete fingerprint record, and then enter [2] to delete all fingerprint records. After hearing a voice prompt of "Succeeded", press [*] until you exit the master mode.

Delete a Key Tag



Enter [#], enter master PIN code and confirm with [#].



Enter [3] to delete a user record, then enter [4] to delete key tag record, and then enter [1] to delete one single key tag record. After hearing a voice prompt of "Succeeded", press [*] until you exit the master mode.

Delete All Key Tags



Enter [#], enter master PIN code and confirm with [#].



Enter [3] to delete a user record, then enter [4] to delete key tag record, and then enter [2] to delete all key tag records. After hearing a voice prompt of "Succeeded", press [*] until you exit the master mode.

System Initialization

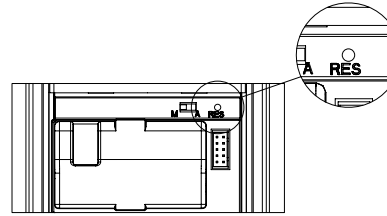

Remove the battery cover, then double press the [RES] hole with a sharp object, after hearing a voice prompt of "Restoring to default settings", all user information will be emptied.

System Settings

Language Settings



Enter [#], enter master PIN code and confirm with [#].



Enter [4] to get into system settings, then enter [1] to get into language settings.



Choose the language as needed: For Chinese, press [1]; for English, press [2]. After hearing a voice prompt of "Succeeded", press [*] until you exit the master mode.

⚠ Attention

The default language is English.

Volume Settings



Enter [#], then enter master PIN code and confirm with [#].



Enter [4] to get into system settings, then enter [2] to enter into volume settings.



Choose the volume as needed: For high volume, press [1]; for low volume, press [2]; for mute mode, press [3]. After hearing a voice prompt of "Succeeded", press [*] until you exit the master mode.

⚠ Attention

The default volume is "high volume".

Switch to Dual Verification Mode



Enter [#], then enter master PIN code and confirm with [#].



Enter [4] to get into system settings, then enter [3] to enter into identify verification methods portfolio.



For single verification method, press [1]; for dual verification method, press [2]. After hearing a voice prompt of "Succeeded", press [*] until you exit the master mode.

Extended Functions



Enter [#], enter master PIN code and confirm with [#].

5

Enter [5] to get into extended functions.

1 or 2

To join a network, press [1]. To exit a network, press [2]. Before setting up the extended functions, please download and open Philips EasyKey (APP) from App Stores via your phone.

⚠ Attention

The extended functions are optional.

System Query

Security Code Query



Enter [#], enter master PIN code and confirm with [#].

6 1

Enter [6] to get into system query, then enter [1] to get into security code query, the system will broadcast the product series number automatically.

⚠ Attention

Directly input 400# could enter into system query.

Local Query



Enter [#], enter master PIN code and confirm with [#].

6 2

Enter [6] to get into system query, then enter [2] to get into product software version query, the system will broadcast the product software version automatically.

⚠ Attention

Directly input 114# could enter into local query.

Bluetooth Settings



Enter [#], then enter master PIN code and confirm with [#].

7

Enter [7] to get into Bluetooth settings menu.

3 *

To disable Bluetooth, please press [3]. After hearing a voice prompt of "Settings succeeded", press [*] until you exit the master mode.

⚠ Attention

1. Directly input 403# to enable Bluetooth, and input 404# to disable Bluetooth.
2. When the Bluetooth is off, please press [1] to enable Bluetooth.
3. When using the newly updated EasyKey App to bind with the smart lock, users could follow up the chapter of "Add a device" to finish the binding process.

5. How to use your EasyKey

Unlock | Unlock from outside

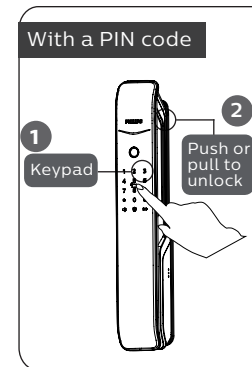

- ① Touch and wake up the keypad, then enter a registered user PIN code and confirm with [#].
- ② After hearing a voice prompt of "Door opened", push or pull the handle to open the door.

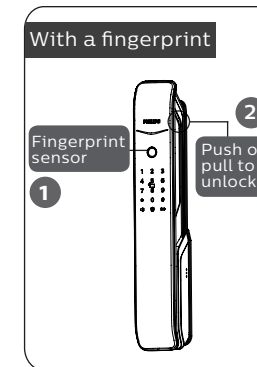

- ① Place the finger of which the fingerprint has been registered against the sensor.
- ② After hearing a voice prompt of "Door opened", push or pull the handle to open the door.

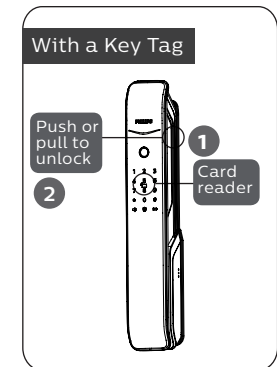

- ① Place the key tag/ card that has been successfully registered properly against the card reader.
- ② After hearing a voice prompt of "Door opened", push or pull the handle to open the door.

Unlock | Unlock from Inside

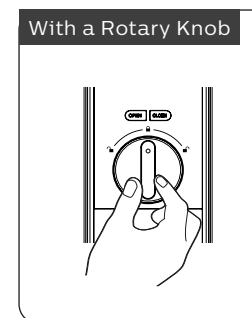

Philips EasyKey employs indoor fast opening mortise. You can unlock from inside by rotating the rotary knob.

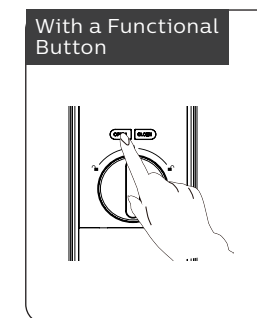

Double press the [OPEN/CLOSE] functional button within one second, then push or pull to unlock.

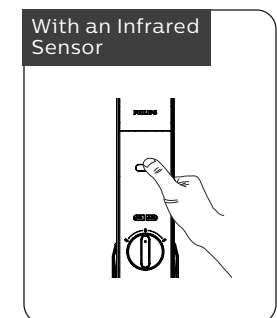

Features with an infrared sensor on the handle, when the sensor is triggered, hold the handle's sensor modules on both the front and rear side simultaneously, you could easily unlock the door.

Lock | Auto/Manual Mode

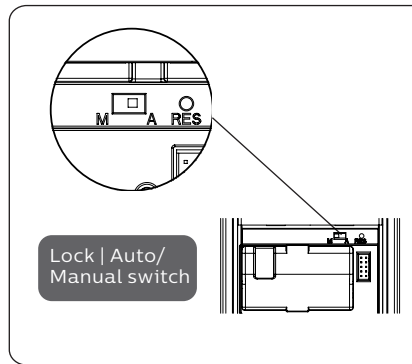



Lock | Auto/Manual switch

[A] indicates auto mode, after closing the door, the latch bolt will pop up, and the door is lock.

[M] indicates manual mode, after closing the door, the latch bolt will not pop up, and the door is open.

Lock from Outside

 When the door is under auto mode, the latch bolt will be popped up after closing the door, and there will be a voice prompt of "Door Close".

 When the door is under manual mode, the latch bolt won't pop up after closing the door. Only after a successful verification among any of the registered identity methods (PIN Code/Key Tag/Fingerprint), the latch bolt will pop up, and there will be a voice prompt of "Door Close". When it is under manual mode and the door is closed, waking up the outside escutcheon and unlock the system could directly open the door.

Lock from Inside

 When the door is under auto mode, the latch bolt will be popped up after closing the door, and there will be a voice prompt of "Door Close".

 When the door is under manual mode, the latch bolt won't be popped up after closing the door. Click on [CLOSE] and the latch bolt will be popped up. After successfully locking the door, the system will generate a voice prompt of "Door Close".



Inside Deadlock

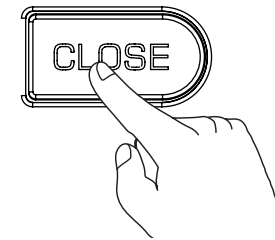

When the EasyKey is locked, long-press the [CLOSE] button, after the indicator flashes once in red, and there will be a voice prompt of "Inside deadlock enabled".

⚠ Attention

Under inside deadlock mode, all functions of the outside escutcheon will be locked. If you try to wake up the system manually, the keypad area will display the combination of "15937(X)" and there will be a voice prompt of "Inside deadlock enabled" reminding you that the door has been deadlocked from inside. Under deadlock mode, all operations of the outside escutcheon are disabled. Master PIN code verification or mechanical key opening is required to release the door from deadlock mode.

Mechanical Key Opening

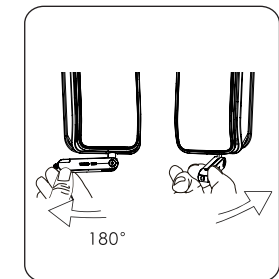
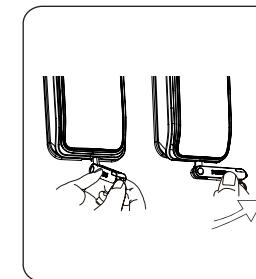
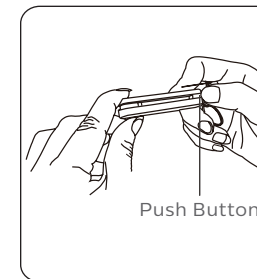

① Cut the box and take out the mechanical keys. Push the cover aside and reveal the key itself.

② Insert the key into the keyhole and keep the key and key shell vertical to each other. Rotate the key shell towards the handle for 90° until it closes to the door surface.

③ Rotate the key shell downwards for 180° to make it parallel to the ground. Then rotate it horizontally towards the handle to unlock the door.

⚠ Attention

It is suggested you not to use the mechanical key for daily unlocking. Use the key for emergencies only, in case the battery is dead, forget the PIN code, or the system fails to work properly.

6 Other Functions

Indoor Infrared Sensor Unlocking

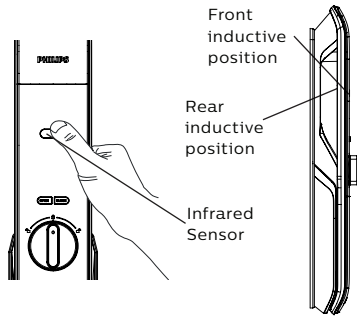

Function:
With indoor infrared sensor unlocking, you could easily unlock the door from inside.

How to use:
Features with the infrared sensor on the handle, when the sensor is triggered, hold the handle's sensor modules on both the front and rear inductive position simultaneously, you could easily unlock the door.

Enable/Disable:
When the infrared sensor unlocking is disabled, long-press the [OPEN] / [CLOSE] button at the same time to turn on the function, and the green light will flash quickly;
When the infrared sensor unlocking is enabled, long-press the [OPEN] / [CLOSE] button at the same time to turn off the function and the red light will flash quickly.

⚠ Attention

When the infrared sensor unlocking is disabled, the indoor inductive unlocking is inactive. When you touch the front and rear of the inductive position on the handle, the red light will light up to remind you that the indoor inductive unlocking is off.

Restore to Default Settings

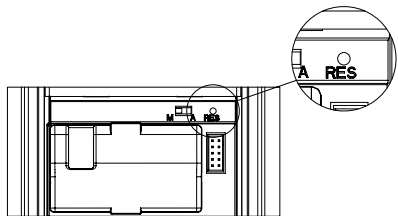

Functions:
Emptying all user records and restore to default settings.

How to use:
Double press the [RES] with a sharp object, and all user records in the system will be emptied, and the system will restore to default settings.

Mute Mode

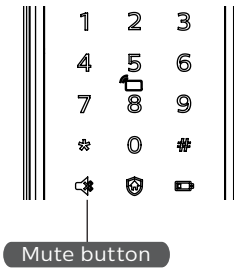

Functions:

Use only one button to mute the lock by turning off the voice guide. Applicable to the scenes where you don't want to disturb your family.

How to use:

1.Mute: When the system is awake, long-press the [Mute] button for 2 seconds to enter one-time mute mode. The button will glow green.

2.Unmute: When the system is awake, long-press the [Mute] button for 2 seconds to restore the voice guide. The button will glow white.

Outside Forced Lock

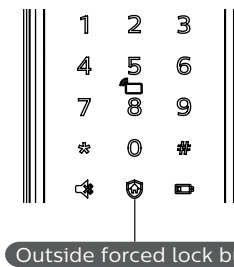

Functions:

Unlocking from inside will trigger an alarm.

How to use:

After the door is successfully locked, long-press the button for 2 seconds to enter the outside forced lock mode.

⚠ Attention

Enabling the outside forced lock function will not affect unlocking from outside.

7 The use and meanings of indicators

Lock Status Indicator

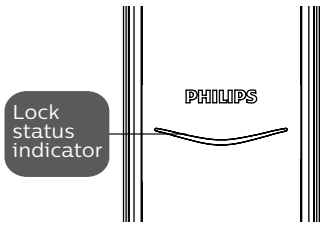

The meanings of different light colors

Blue: When the system wakes up, the light will glow blue, indicating that you can operate the lock.

Green: When the door is unlocked, the light will glow green, indicating that the door is open.

Red: When the door is locked, the light will glow red, indicating that the door is close.

Low Battery Voltage Indicator

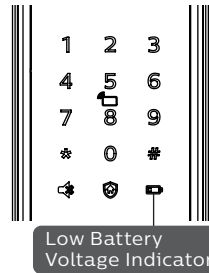

The meanings of different light colors

Red: After waking up, the system will run an automatic examination of the battery voltage. If the voltage is too low, the light will flash in red and there will be a voice prompt of "Low battery voltage. Please replace all batteries".

Outside Forced Lock Indicator

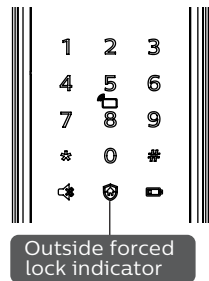

The meanings of different light colors

White:

1. When the door is locked, it will glow in white, indicating that you can enable the outside forced locking.

2. If you have enabled the outside forced locking, when the system wakes up, the light will glow in white, indicating this function is in use.

Mute mode indicator

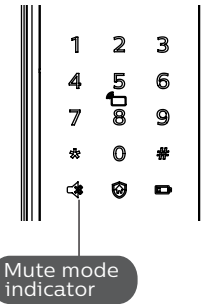

The meanings of different light colors

1. **White:** Indicates the mute mode is off.

2. **Green:** Indicates the mute mode is on.

Inside Deadlock Indicator

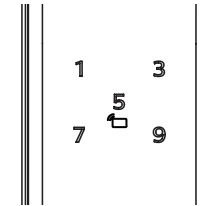

When the door is under inside deadlocking, the digital functions of the outside escutcheon will be locked.

If the system wakes up manually, the keypad will show the combination of "15937 (X)" with a voice prompt of "inside deadlocking enabled".

System Locked Indicator

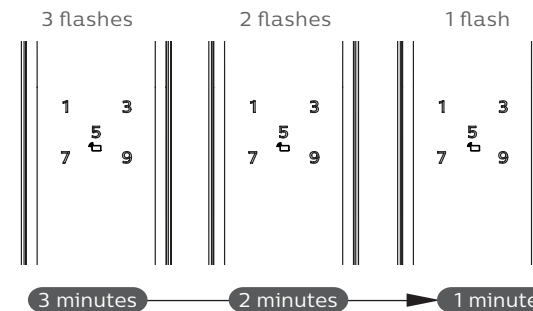

If any of the verification methods among fingerprint, password, or card/key tag has scanned to be incorrect and the number of consecutive incorrect entries reaches 5 times within 5 minutes, the EasyKey will be locked for 3 minutes.

⚠ Attention

Only under any of the verification methods above or the keypad is wakened up, will the prompt be seen.

[OPEN/CLOSE] Indicator

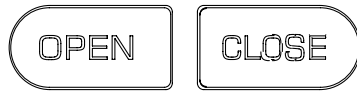

The meanings of different light colors

1. With 2 flashes in red: indicates the door is locking.
2. With 2 flashes in green: indicates the door is unlocking.
3. With 1 flash in red: indicates the door is deadlocking.

Infrared Sensor Opening Indicator

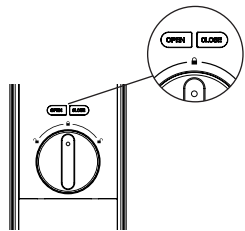

The meanings of different light colors

1. Fast flashing in green: Infrared sensor opening is on.
2. Fast flashing in red: Infrared sensor opening is off.

8 Troubleshooting

Alarm Types and Modes

Inside Unlocking Alarm Under Outside Forced Lock

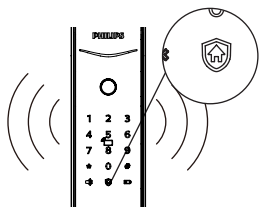

Triggering: If the lock is under outside forced lock mode, unlocking from inside will trigger the alarm.

Alarm mode: Continuously repeated alarms.

Turning off: The alarm can be turned off by successful verification of any type.

Low Battery Voltage Alarm reminds you of replacing the batteries in time

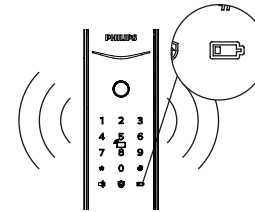

Triggering: After waking up, the system will run an automatic examination on the battery voltage. If the voltage is too low, the lock will give an alarm with a voice prompt of "Low battery voltage. Please replace all batteries".

Alarm mode: A voice prompt of "Low battery voltage. Please replace all batteries" during unlocking.

Turning off: The alarm will be automatically turned off.

Anti-dismantling Alarm

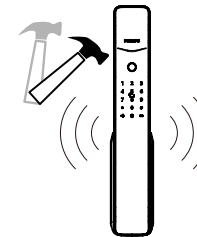

Triggering 1: The door is pried open and the sensor latch bolt pops up.

Alarm mode: Continuously repeated alarms.

Turning off: The alarm can be turned off automatically or by a successful verification.

Triggering 2: The door is pried open and there is no close fit in the door.

Alarm mode: Continuously repeated alarms.

Turning off: The alarm can be turned off automatically, by a successful verification from outside or normal unlocking from inside.

Deadbolt Abnormality Alarm

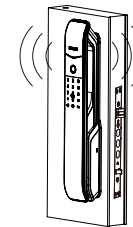

Triggering: The deadbolt works abnormally, fails to lock or unlock the door.

Alarm mode: Continuously repeated alarms.

Turning off: The alarm will be automatically turned off.

How to apply emergency power supply

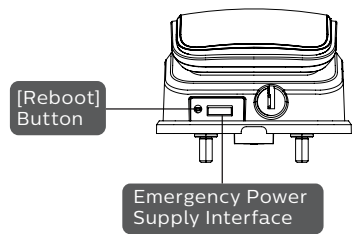

When the battery voltage is insufficient, and the door cannot be opened from the outside, you can power up the lock through the Micro USB interface by using a 5V power bank as an emergency power supply. After opening the door, please replace the batteries immediately.

In case of a system crash and it's impossible to open the door from outside, please press the [RES] button and then release it to reboot automatically.

How to replace batteries

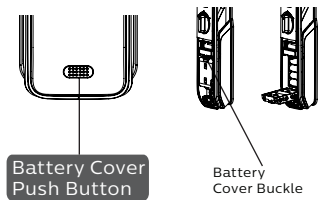

The lock is powered by four 1.5V alkaline batteries. There are two sets of working power stations in the battery cabinet. Eight batteries can put in to extend battery life and reduce battery replacement frequency.

The battery cabinet locates at the bottom end of the inside escutcheon. By pushing the cover upwards, you can remove it and replace the batteries.



Philips and the Philips Shield Emblem are registered trademarks of Koninklijke Philips N.V. and are used under license. This product has been manufactured by and is sold under the responsibility of Shenzhen Conex Intelligent Technology Co., Ltd. and Shenzhen Conex Intelligent Technology Co., Ltd. is the warrantor concerning this product.