

Register your product and get support at  
[www.philips.com/welcome](http://www.philips.com/welcome)

---

User Manual

---

**For further assistance, call the customer support service in your country.**

- To obtain assistance, contact Philips Customer Care Center;  
In the U.S.A., Canada, Puerto Rico, or the U.S. Virgin Islands; 1- 866-515-1124

# PRECAUTIONS

## Supplied Accessories

- Remote Control (NC091UL)
- Audio/video cables
- Quick Start Guide

## Connecting to RF Modulator (Not Supplied)

If your TV has “Antenna In (RF in)” jack only, it is still possible to connect this unit to your TV by using an RF Modulator.

In this case, follow the instructions below.

- 1) Disconnect the Power cords of the devices from the AC outlet.
- 2) Make the Connection as illustrated below.
- 3) Set your RF Modulator's channel 3/4 switch to either 3 or 4, whichever the TV channel is least used in your area. If your RF Modulator has a Modulator/Antenna switch, set it according to the manual supplied with the RF Modulator.
- 4) Plug in the Power cords of the devices to an AC outlet.
- 5) Turn On your TV and choose the same channel as you set to the RF Modulator's channel 3/4 switch to. For more details, follow the manual supplied with the RF Modulator.

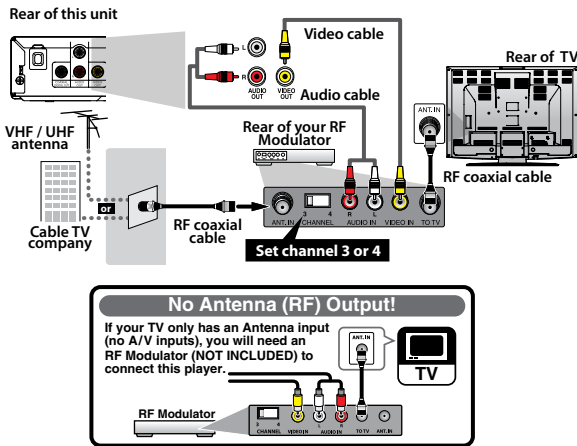

### Note(s):

- RF Modulator is not supplied with this unit. You need to purchase it at your local store.
- The quality of picture may become poor if this unit is connected to an RF Modulator.

## Contents

### PRECAUTIONS

<b>IMPORTANT SAFETY INSTRUCTIONS</b> .....	3
<i>About the Discs</i> .....	6
Playable Discs.....	6
Unplayable Discs.....	6

### SETUP

<b>Connections</b> .....	7
Rear Terminals.....	7
Connection to a TV.....	8
Connection to an Audio System.....	9
<i>About the Remote Control</i> .....	10
Remote Control.....	10
Installing the Batteries for the Remote Control.....	10

### DVD FUNCTIONS

<i>Playback</i> .....	11
<i>JPEG Playback</i> .....	12
<i>Search Functions</i> .....	12
Using Track / File Search.....	12
Using Title / Chapter Search.....	12
Using Time Search.....	12
<i>On-Screen Display</i> .....	13
<i>Repeat / Random Playback</i> .....	14
Repeat Playback.....	14
Repeat A-B Playback.....	14
Random Playback.....	14
<i>Special Settings</i> .....	15
Subtitle Language.....	15
Audio Language.....	15
Camera Angles.....	15
<i>DVD Settings</i> .....	16
System Settings.....	17
Language Settings.....	18
Audio Settings.....	19
Video Settings.....	20
Preference Settings.....	21

### INFORMATION

<i>Troubleshooting Guide</i> .....	22
<i>Specifications</i> .....	22
<b>LIMITED WARRANTY</b> .....	23

The model and serial numbers of this unit may be found on the cabinet. Model No.: \_\_\_\_\_  
You should record and retain those numbers for future reference.

Serial No.: \_\_\_\_\_

**WARNING:** TO REDUCE THE RISK OF FIRE OR ELECTRIC SHOCK, DO NOT EXPOSE THIS APPARATUS TO RAIN OR MOISTURE. APPARATUS SHALL NOT BE EXPOSED TO DRIPPING OR SPLASHING AND NO OBJECTS FILLED WITH LIQUIDS, SUCH AS VASES, SHALL BE PLACED ON THE APPARATUS.



**CAUTION**  
**RISK OF ELECTRIC SHOCK DO NOT OPEN**



**CAUTION:**

TO REDUCE THE RISK OF ELECTRIC SHOCK, DO NOT REMOVE COVER (OR BACK). NO USER SERVICEABLE PARTS INSIDE. REFER SERVICING TO QUALIFIED SERVICE PERSONNEL.



The lightning flash with arrowhead symbol, within an equilateral triangle, is intended to alert the user to the presence of uninsulated "dangerous voltage" within the product's enclosure that may be of sufficient magnitude to constitute a risk of electric shock to persons.



The exclamation point within an equilateral triangle is intended to alert the user to the presence of important operating and maintenance (servicing) instructions in the literature accompanying the appliance.

The important note and rating are located on the rear or bottom of the cabinet.



The symbol for CLASS II (Double Insulation)

## IMPORTANT SAFETY INSTRUCTIONS

1. Read these instructions.
2. Keep these instructions.
3. Heed all warnings.
4. Follow all instructions.
5. Do not use this apparatus near water.
6. Clean only with dry cloth.
7. Do not block any ventilation openings. Install in accordance with the manufacturer's instructions.
8. Do not install near any heat sources such as radiators, heat registers, stoves, or other apparatus (including amplifiers) that produce heat.
9. Do not defeat the safety purpose of the polarized or grounding-type plug. A polarized plug has two blades with one wider than the other. A grounding type plug has two blades and a third grounding prong. The wide blade or the third prong are provided for your safety. If the provided plug does not fit into your outlet, consult an electrician for replacement of the obsolete outlet.
10. Protect the power cord from being walked on or pinched particularly at plugs, convenience receptacles, and the point where they exit from the apparatus.
11. Only use attachments/ accessories specified by the manufacturer.
12. Use only with the cart, stand, tripod, bracket, or table specified by the manufacturer, or sold with the apparatus. When a cart is used, use caution when moving the cart/ apparatus combination to avoid injury from tip-over.
13. Unplug this apparatus during lightning storms or when unused for long periods of time.
14. Refer all servicing to qualified service personnel. Servicing is required when the apparatus has been damaged in any way, such as power-supply cord or plug is damaged, liquid has been spilled or objects have fallen into the apparatus, the apparatus has been exposed to rain or moisture, does not operate normally, or has been dropped.



### FCC WARNING

This equipment may generate or use radio frequency energy. Changes or modifications to this equipment may cause harmful interference unless the modifications are expressly approved in the manual. The user could lose the authority to operate this equipment if an unauthorized change or modification is made.

### RADIO-TV INTERFERENCE

This equipment has been tested and found to comply with the limits for a Class B digital device, pursuant to Part 15 of the FCC Rules. These limits are designed to provide reasonable protection against harmful interference in a residential installation. This equipment generates, uses, and can radiate radio frequency energy and, if not installed and used in accordance with the instructions, may cause harmful interference to radio communications. However, there is no guarantee that interference will not occur in a particular installation. If this equipment does cause harmful interference to radio or television reception, which can be determined by turning the equipment off and on, the user is encouraged to try to correct the interference by one or more of the following measures:

- 1) Reorient or relocate the receiving antenna.
- 2) Increase the separation between the equipment and receiver.
- 3) Connect the equipment into an outlet on a circuit different from that to which the receiver is connected.
- 4) Consult the dealer or an experienced radio/TV technician for help.

**Disconnect the mains(AC) plug to shut off when find trouble or not in use. The mains(AC) plug shall remain readily operable.**

**CAUTION:** Danger of explosion if battery is incorrectly replaced. Replace only with the same or equivalent type.  
**WARNING:** Batteries (Battery pack or battery installed) shall not be exposed to excessive heat such as sunshine, fire or the like.

#### LASER SAFETY

This apparatus is classified as a CLASS 1 LASER PRODUCT.

This apparatus employs a laser. Only a qualified service person should remove the cover or attempt to service this apparatus, due to possible eye injury.



**CAUTION:** Use of controls or adjustments or performance of procedures other than those specified herein may result in hazardous radiation exposure.

#### IMPORTANT COPYRIGHT INFORMATION

Unauthorized copying, broadcasting, public performance and lending of discs are prohibited. This item incorporates copy protection technology that is protected by U.S. patents and other intellectual property rights of Rovi Corporation. Reverse engineering and disassembly are prohibited.

Do not place the unit on the furniture that is capable of being tilted by a child and an adult leaning, pulling, standing or climbing on it. A falling unit can cause serious injury or even death.

In order to avoid interruption of ventilation, this unit should not be placed in built-in equipment such as a book cabinet, rack, etc., and the vents of this unit should not be covered with anything such as a tablecloth, curtain, newspaper, etc. Make sure to leave a space of 4.0 inches (10cm) or more around this apparatus.

When installing this unit in a temperate environment, avoid a place with rapid temperature changes.

This unit should not be used in a tropical environment as it has not been evaluated under such conditions.

No objects should be placed directly on or under this unit, especially lighted candles or other flaming objects.

Never use a gas duster on this unit.  
The gas trapped inside of this unit may cause ignition and explosion.

#### To Avoid the Hazards of Electrical Shock and Fire

- Do not handle the AC power cord with wet hands.
- Do not pull on the AC power cord when disconnecting it from an AC outlet. Grasp it by the plug.
- Do not put your fingers or objects into the unit.

#### Location and Handling

- Do not install the unit in direct sunlight, near strong magnetic fields, or in a place subject to dust or strong vibration.
- Avoid a place with drastic temperature changes.
- Install the unit in a horizontal and stable position. Do not place anything directly on top or bottom of the unit. Depending on your external devices, noise or disturbance of the picture and/or sound may be generated if the unit is placed too close to them. In this case, please ensure enough space between the external devices and the unit.
- Depending on the environment, the temperature of this unit may increase slightly. This is not a malfunction.
- Be sure to remove the disc and unplug the AC power cord from the outlet before carrying the unit.

#### Dew Condensation Warning

- Dew condensation may form inside the unit in the following conditions. If so, do not use this unit at least for a few hours until its inside gets dry.
  - The unit is moved from a cold place to a warm place.
  - Under conditions of high humidity.
  - After heating a cold room.

#### Note about Recycling

- This unit's packaging materials are recyclable and can be reused. Please dispose of any materials in accordance with your local recycling regulations.
- Batteries should never be thrown away or incinerated but disposed of in accordance with your local regulations concerning chemical wastes.
- For product recycling information, please visit - [www.recycle.philips.com](http://www.recycle.philips.com)



#### Notice for Progressive Scan Output

- Consumers should note that not all high definition television sets are fully compatible with this product and may cause artifacts to be displayed in the picture. In case of picture problems with 525(480) progressive scan output, it is recommended that the user switch the connection to the 'standard definition' output.

#### Disposal of Used Batteries

- In certain localities, disposing batteries with household waste is not permitted. Please ensure you dispose of batteries according to local regulations.

## TRADEMARK INFORMATION



Manufactured under license from Dolby Laboratories. Dolby, Dolby Audio, and the double-D symbol are trademarks of Dolby Laboratories.



ENERGY STAR® is a joint program of the U.S. Environmental Protection Agency and the U.S. Department of Energy helping us all save money and protect the environment through energy efficient products and practices.



is a trademark of DVD Format/Logo Licensing Corporation.

## SYMBOLS USED IN THIS MANUAL

The following symbols appear in some headings in this manual.



: Description refers to DVD-video.



: Description refers to audio CD.



: Description refers to DVD, CD-RW/-R with JPEG files.

## MAINTENANCE

### Servicing

- Please refer to relevant topics on the “Troubleshooting Guide” on page 22. If you cannot find any solution there, our service center is pleased to assist you.
- Even if this unit becomes inoperative, Do Not open the cabinet to repair it by yourself. There are No user-serviceable parts inside.  
Turn Off the unit, unplug the AC Power plug and then call our support center mentioned on the front page. Before calling, please check Model and Serial number on the unit.

### Cleaning the Cabinet

- Wipe the front panel and other exterior surfaces of the unit with a soft cloth.
- Never use a solvent, thinner, benzene or alcohol to clean the unit. Do not spray insecticide liquid near the unit. Such chemicals may discolor the surface or damage the unit.

### Cleaning Discs

- When a disc is dirty, clean it with a cleaning cloth. Wipe the disc from the center to the outside. Do not wipe in a circular motion.
- Do not use solvents such as benzine, thinner, commercially available cleaners, detergent, abrasive cleaning agents or antistatic spray intended for analog records.

### Cleaning the Disc Lens

Depends on unit circumstances, the laser optical pickup unit's Disc Lens may get dirty.

If this unit still does not perform properly although you refer to the relevant sections and to “Troubleshooting Guide” in this owner's manual, consult a local dealer or an authorized service center for inspection and cleaning of the Disc Lens.

### Disc Handling

- When you handle a disc, hold it by its edge and try not to touch the surface of the disc.
- Always store the disc in its protective case when not in use.

# About the Discs

## Playable Discs

Type of media	Mark (logos)	Region codes	Recorded signals	Disc sizes	Disc types
DVD-video *1, 2, 4, 6, 8		or	digital video (MPEG2)	5 inches (12 cm) or 3 inches (8 cm)	<p>DVD-Video e.g.) title 1   title 2 chapter 1   chapter 2   chapter 3   chapter 4   chapter 1   chapter 2</p>
DVD-RW DVD-R *1, 3, 4, 5, 6, 7, 8		—	digital video (MPEG2) or JPEG		<p>DVD e.g.) title 1   title 2 chapter 1   chapter 2   chapter 3   chapter 4   chapter 1   chapter 2</p> <p>JPEG e.g.) folder 1   folder 2 file 1   file 2   file 3   file 4   file 1   file 2</p>
audio CD *4, 6, 8		—	digital audio	5 inches (12 cm) or 3 inches (8 cm)	<p>audio CD e.g.) track 1   track 2   track 3   track 4   track 5   track 6</p>
CD-RW CD-R *4, 5, 6, 7, 8		—	digital audio or JPEG		<p>JPEG e.g.) folder 1   folder 2 file 1   file 2   file 3   file 4   file 1   file 2</p>

### If you cannot play back a disc which bears one of the marks above, check the following notes.

- \*1: This unit conforms to the NTSC color system. Discs recorded in other color systems such as PAL cannot be played back.
- \*2: Certain DVD-video do not operate as described in this manual due to the intentions of the disc's producers.
- \*3: Discs recorded in the VR (Video Recording) format cannot be played back.
- \*4: Scratched or stained discs may not be played back.
- \*5: Some discs cannot be played back because of incompatible recording conditions, characteristics of the recorder or special properties of discs.
- \*6: You can play back discs which bear the marks above. If you use non-standardized discs, this unit may not play them back. Even if they are played back, the sound or video quality will be compromised.
- \*7: If the recorded portion of the disc is too small (smaller than 2-3/16 inches (55mm) across), it may not be played back.
- \*8: Do not glue paper or put stickers on to the disc. These may damage the disc, and the unit may not read it correctly.

## Unplayable Discs

### NEVER play back the following discs as a malfunction may result!

DVD-audio / DVD-RAM / DVD-ROM for personal computers / DVD with region codes other than 1 or ALL / CD-ROM for personal computers / HD DVD / Blu-ray Disc™ / photo CD / CD-i / video CD

### Any other discs without compatibility indications.

#### Note(s):

- Only the sound recorded on the normal CD layer can be delivered. The sound recorded on the high density super audio CD layer cannot be delivered.

# SETUP

## Connections

### Rear Terminals

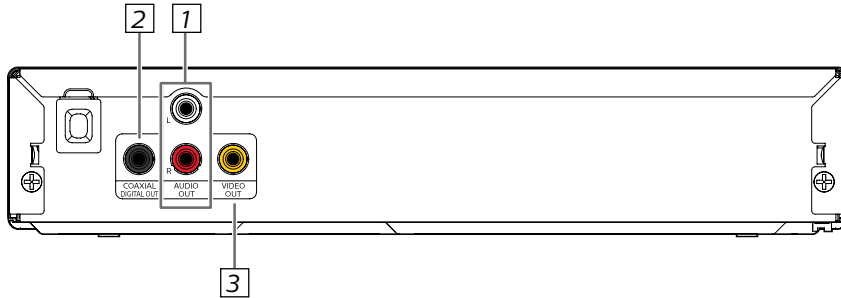

- |                                   |   |
|-----------------------------------|---|
| <b>1 AUDIO OUT jacks</b>          | Connect an Audio cable here through the Audio Input jacks on a Television or another Audio device.                      |
| <b>2 COAXIAL DIGITAL OUT jack</b> | Connect a Digital Audio Coaxial cable here through the Digital Audio Coaxial Input jack on a decoder or audio receiver. |
| <b>3 VIDEO OUT jack</b>           | Connect a Video cable here through the Video Input jack on a Television.  |

#### **Note(s):**

· Please purchase the necessary cables at your local store. (Refer to pages 8 - 9.)

## Connection to a TV

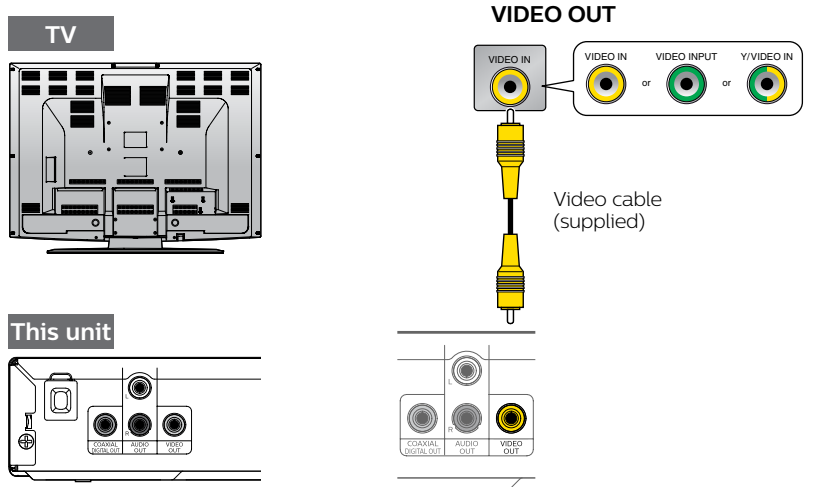

and

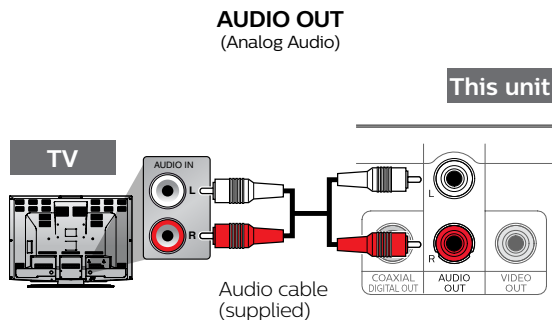

Supplied cables used in this connection are as follows:

- Audio cable (L/R) × 1
- Video cable × 1

### Note(s):

- Connect this unit directly to your TV.  
If Audio/Video cables are connected to a VCR, pictures may be distorted due to the copy protection system.

### After connecting to your TV:

You will need to find the viewing channel (external input channel) on your TV.  
Please refer to your TV's Owner's manual for details.

### Input modes for common TV brands:

Listed below are inputs for common brand name TV's.

Philips:	VIDEO, SOURCE	RCA:	INPUT, TV/VCR, 00, 90, 91, 92, 93
Emerson:	VIDEO, AUX	Samsung:	TV/VIDEO
Hitachi:	INPUT, AUX	Sanyo:	VIDEO
JVC:	VIDEO, VIDEO1, VIDEO2, VIDEO3	Sharp:	00
LG:	INPUT, AUX	Sony:	VIDEO1, VIDEO2, VIDEO3
Magnavox:	AUX CHANNEL, SOURCE	Toshiba:	TV/GAME
Panasonic:	TV/VIDEO		



Connection to an Audio System

Analog Audio Connection

Stereo system with Analog Audio Input jacks

Audio

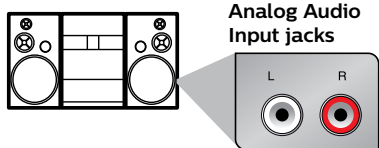

Audio cable (supplied)

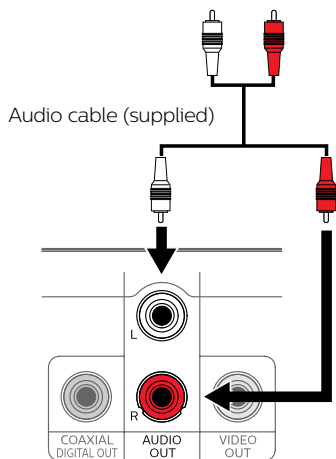

This unit

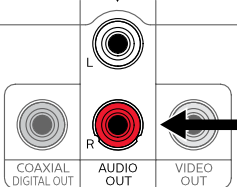

AUDIO OUT

Supplied cables used in this connection are as follows:

- Audio cable (L/R) × 1

Please purchase the rest of the necessary cables at your local store.

Digital Audio Connection

AV receiver / amplifier with a Coaxial input jack



Coaxial input jack

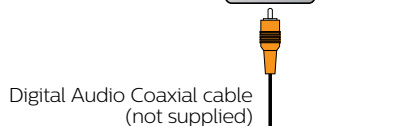

COAXIAL DIGITAL OUT

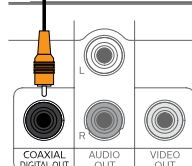

Connection	Setting	[SETUP] → "Audio" → "Digital Audio" →
Connecting to a Dolby Digital decoder for Dolby Digital audio output.		"Bitstream"
Connecting to the other device (an MD deck etc.) without Dolby Digital decoder.		"PCM"

**Note(s):**

- The audio source on a disc in a Dolby Digital multi-channel surround format cannot be recorded as digital sound by an MD deck.
- By hooking this unit up to a Dolby Digital decoder, you can enjoy high-quality Dolby Digital multi-channel surround sound as heard in the movie theaters.
- Playing back a DVD using incorrect settings may generate noise distortion and may also damage the speakers.

# About the Remote Control

## Remote Control



## Installing the Batteries for the Remote Control

Install 2 AAA (1.5V) batteries matching the polarity indicated inside battery compartment of the remote control.

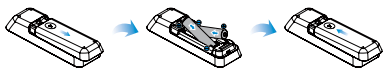

**\* Batteries not supplied.**

Keep in mind the following when using the remote control:

- Make sure that there are no obstacles between the remote control and the remote sensor on the unit.
- The maximum operable ranges from the unit are as follows.

**–Line of sight:**

approx. 23 feet (7m)

**–Either side of the center:**

approx. 16 feet (5m) within 30°

**–Above:** approx. 16 feet (5m) within 15°

**–Below:** approx. 10 feet (3m) within 30°

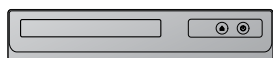

### Note(s):

- Do not mix alkaline, standard (carbon-zinc), or rechargeable (ni-cad, ni-mh, etc) batteries.
- Do not mix old and new batteries.
- Always remove batteries from remote control if they are dead or if the remote control is not to be used for an extended period of time. This will prevent battery acid from leaking into the battery compartment.

Button (Alphabetical order)	Media	DVD	CD	JPEG
		• To move the Cursor. • To enter values in the input field.		• To switch between pages when a file list is displayed. • To Rotate the picture during playback of JPEG Files. (JPEG)
		• To Repeat between your chosen points A and B. (DVD) (CD)		
		• To select Camera Angles on a disc.		
		• To select Audio language on a disc.		
		• To Display the current disc information.		
		• To Select Items or Settings.		
		• To Search Forward/Backward through a disc. (x2, x4, x8, x20) (DVD) (CD)		
		• To Begin Slow Forward Playback in the Pause mode.		
		• To Call up the menu on a disc.		• To Display the Thumbnail when a disc with JPEG Files is inserted and the File is highlighted. (JPEG)
				• To Play Back Randomly. (CD)
		• To Open or Close the Disc tray. • To turn On the unit.		
		• To Pause disc Playback. • To Advance Playback one Frame at a time.		
		• To Start Playback or Resume Playback.		
		• To Play Back a Chapter, Title or Disc Repeatedly.		• To Play Back Repeatedly.
		• To Call up the Menu when Playing Back a disc.		• To Return to the File List when Thumbnail is displayed. (JPEG)
		• To Search Chapter, Title or Time. • To select button in menu. (DVD)		• To Search Tracks or Files. • To Search Time. (CD)
		• To Call up the Setup menu.		
		• To Skip Chapters or Titles.		• To Skip Tracks. • To Switch between pages when Thumbnail is displayed. (JPEG).
		• To Turn the unit On or to Turn the unit into the Standby mode. (To Completely turn Off the unit, you must Unplug the AC Power cord.)		
		• To Stop Playback.		
		• To Select Subtitle Language on a disc.		
		• To Call up the Title Menu on a disc.		
		• To Magnify part of a Picture. (x1.5, x2, x2.5) (DVD) (JPEG)		

# DVD FUNCTIONS

**Please note :**

- Most instructions in this manual refer to Remote Control use.
- This unit will automatically turn On the Screen Saver after 5 minutes of inactivity and into the Standby mode after 25 minutes of inactivity.

## Playback

**Before:**

Turn On the TV, Amplifier and any other Device(s) which are connected to this unit. Make sure the TV and Audio Receiver (not supplied) are set to the correct Channel/Input.



(JPEG ⇒ on page 12)

- 1 Press [ ] to turn on this unit.
- 2 Press [ ] and insert a disc with label facing up.
- 3 Press [ ] to start playback.
- 4 Press [ ] to stop playback.

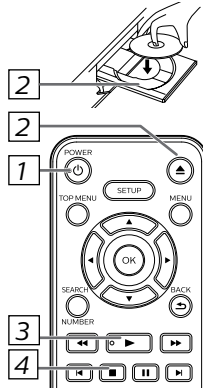

### Disc Menu



Some discs contain menus which allow you to customize DVD playback. Use [ ]/[ ]/[ ] to select an item, then press [OK], [ ] (on the unit).

### Calling Up a Menu Screen during Playback



- Press [MENU] to call up the Disc menu.
- Press [TOP MENU] to call up the Title menu.

**Note(s):**

- Menu operations may vary depending on the disc. Refer to the manual accompanying the disc for more details.

### Resume Playback



Press [ ] during Playback. PRE STOP icon will appear at the top-left on the TV screen. Press [ ]. RESUME icon will appear at the top-left on the TV screen and Playback will Resume from the Point where Playback was Stopped.



**Note(s):**

- To Cancel Resume, press [ ] one more time in the Stop mode.
- The Resume Playback information stays in unit Memory even when the Power is turned Off, as long as the Disc stays in the unit.

### Pause and Step-by-Step Playback



Press [ ] during playback. To continue Playback, press [ ].



The disc goes forward by one Frame each time [ ] (on the remote control) is pressed in the Pause mode. To continue Playback, press [ ].

Lights up when power is On.

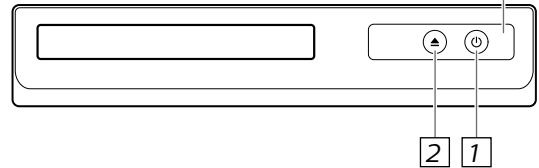

**Note(s):**

- When you Play back a DVD or CD-R/-RW with JPEG Files, refer to details on page 12.
- “This operation is not available.” may appear at the Top-left on the TV Screen when the operation is prohibited by the disc or this unit.
- Some DVD may Start Playback from title 2 or 3 due to specific programs.
- During the Playback of a 2-layered disc, pictures may Stop for a moment. This happens while the 1st layer is being switched to the 2nd layer. This is Not a Malfunction.
- You can change the On-screen language in “Menu” setting. (Refer to page 18.)

### Fast Forward / Reverse Search



Use [ ] or [ ] Repeatedly during Playback to select the required Forward or Reverse Speed. To continue Playback, press [ ].



**Note(s):**

- Fast Forward or Reverse Search speed is different depending on the disc. Approximate speed is x2, x4, x8 and x20.

### Slow Forward Search



Press [ ] Repeatedly in the Pause mode to select the required Forward speed. To continue Playback, press [ ].



**Note(s):**

- Slow Forward speed is different depending on the disc. Approximate speed is x1/2, x1/4 and x1/8.

### Zoom



- 1) Press [ZOOM] Repeatedly during Playback to select the required Zoom factor: x1.5, x2 or x2.5.
- 2) Use [ ]/[ ]/[ ] to Slide the Zoomed Picture across the TV Screen.
- 3) To Exit the Zoom function, press [ZOOM] Repeatedly to select “ZOOM 1”(Off).



**Note(s):**

- Zooming function does not work while the Disc Menu is displayed.
- Some Part of the Picture may not be Zoomed depending on the Disc or Playback status.

# JPEG Playback

JPEG is a method of compressing data in files. You can copy JPEG files on DVD or CD-R/-RW from a computer and Play back the Files on this unit.



Insert a JPEG formatted disc, then the File List will automatically appear on the TV screen. (For a disc with JPEG files only)

1 Select the desired Folder or File.

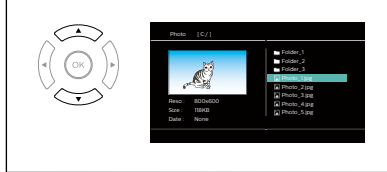

2 Press [OK] or [▶] (on the unit). Playback will Start from the first File of the Folder or Files.

It is recommended that the files are recorded under the following conditions :

Applicable JPEG file	Remarks
<b>Normal playback</b> Pixel upper limit: 6,000 × 6,000 pixel Pixel lower limit: 96 × 96 pixel	A JPEG image that extends beyond the screen is reduced so that it will be displayed within the screen.

### Note(s):

- Some selections may take a while to be recognized.
- Refer to "On-Screen Display" on page 13 for more details.
- A Maximum of 189 folders or 9999 files may be recognized on One disc. (ISO9660 format files)
- For UDF format files recorded on DVD Media, maximum of 2,000 files may be recognized. It may take a while to switch between pages for a file list.
- Up to 8 hierarchies can be recognized in one folder. File in the 9th or deeper hierarchies cannot be played back.
- To Rotate the Picture, press the Cursor buttons during Playback of JPEG Files.

# Search Functions

## Using Track / File Search      Using Title / Chapter Search      Using Time Search



Using [SEARCH/NUMBER]



Available Search Mode	Displayed list
Track Search	
File Search	File list / Thumbnail



- Displayed digit differs depending on the contents. The same number of digits that are stored on the disc must be entered.
- Press cursor [◀] or [▶] to move the digit that you wish to change.
- Press cursor [▲] or [▼] to change the number.

3 Press [OK].

### Note(s):

- The random playback will be cleared when you select track search during random playback (for CD only).

Using [◀◀, ▶▶] (SKIP)

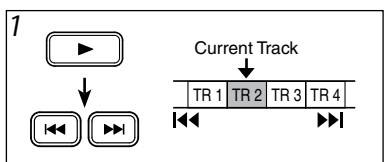

Using [SEARCH/NUMBER]



- Press [SEARCH/NUMBER] once for the title search.

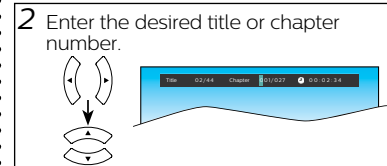

- For the chapter search, press cursor [▶] to highlight the chapter number.
- Title number is displayed with 2-digit, Chapter number is displayed with 3-digit.
- Press cursor [◀] or [▶] to move the digit that you wish to change.
- Press cursor [▲] or [▼] to change the number.

3 Press [OK].

Using [◀◀, ▶▶] (SKIP)

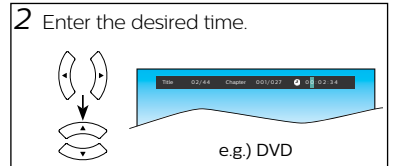
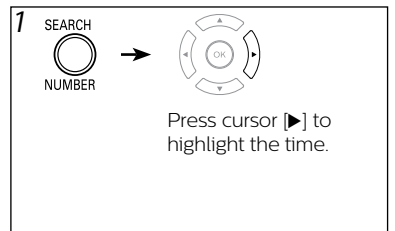
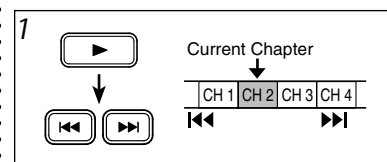

- Press cursor [◀] or [▶] to move the digit that you wish to change.
- Press cursor [▲] or [▼] to change the number.

3 Press [OK].

### Note(s):

- The random playback will be cleared when you select time search during random playback (for CD only).

# On-Screen Display

You can check the information about the current disc by pressing **[INFO]**.

**DVD**

1 **[INFO]**

A: Current Title Number / Total Titles  
 B: Current Chapter Number / Total Chapters  
 C: Elapsed Time of the Current Time

2 **[INFO]**

D: Currently Selected Language / Total Languages  
 E: Current Audio  
 F: Currently Selected Subtitle / Total Subtitles  
 G: Currently Selected Angle / Total Angles

3 **[INFO]**

**CD**

1 **[INFO]**

A: Current Track Number / Total Tracks  
 B: Current Repeat Mode  
 Track Repeat :   
 Repeat All :   
 C: Elapsed Time of the Current Time

2 **[INFO]**

**JPEG**

Insert a JPEG formatted disc, then the Folder / File list will automatically appear on the TV Screen.

Press **[MENU]** to Display the Thumbnail Screen while an available File is highlighted.

Thumbnail  
(only while JPEG file list is displayed)

Folder Name    File / Folder list

Photo [C:/1]

Photo:

Resolution of the File: 800x600  
 File Size: 18KB  
 Date of the File: None

Folder\_1  
 Folder\_2  
 Folder\_3  
 Photo\_1.jpg  
 Photo\_2.jpg  
 Photo\_3.jpg  
 Photo\_4.jpg  
 Photo\_5.jpg

Thumbnail

MENU

BACK

File Name

Press **[<<]** or **[>>]** to Switch between Pages.  
 Press **[BACK]** to Go Back to the File List.

# Repeat / Random Playback

## Repeat Playback



Repeat function is available Only during Playback.

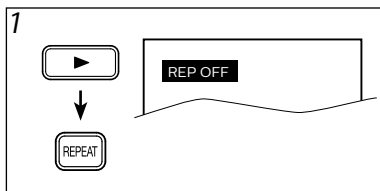

Each time you press **[REPEAT]**, Repeat Function Changes as example below.

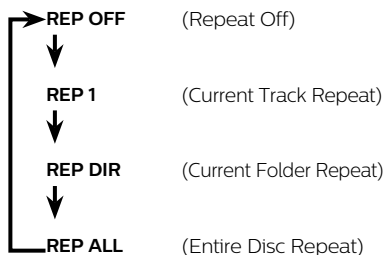
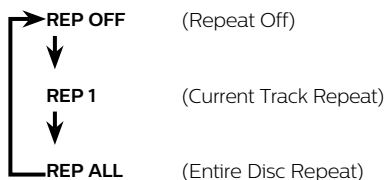
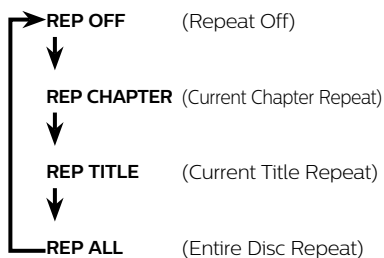

## Repeat A-B Playback



Repeat Function is available Only during Playback.

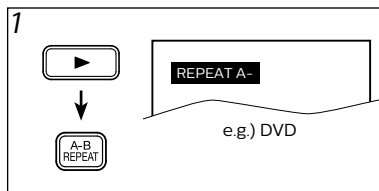

Press **[A-B REPEAT]** at your desired Starting Point. (A)

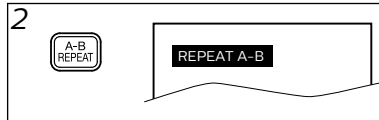

Press **[A-B REPEAT]** again at your desired Ending point. (B)  
 · Point B should be in the Same Title or Track as Point A.

### Note(s):

- To Exit the Sequence, press **[A-B REPEAT]** so that "A-B CANCEL" appears.

## Random Playback



This function Shuffles the Playing Tracks in a Random mode instead of Playback in a Sequential Track mode.

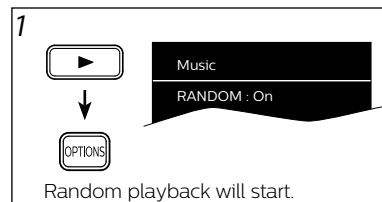

### Note(s):

- During Random Playback, you cannot go back to the Previous track. Press **[▶▶]** to Search Tracks or Files Randomly.

# Special Settings

## Subtitle Language



This unit allows you to Select a Subtitle Language **(if available)** during DVD Playback.

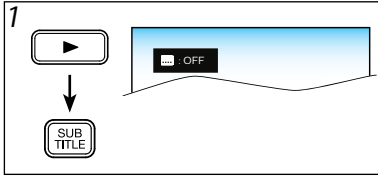

Each time you press **[SUBTITLE]**, Subtitle Language changes as example below.

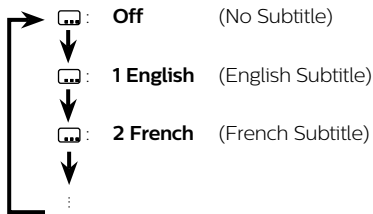

### Note(s):

- If your language is not shown after pressing **[SUBTITLE]** several times, the disc may not have that language. However, some discs allow subtitle language setting on the disc menu. (Operation varies depending on the disc, so refer to the manual along with the disc.)
- When "X This operation is not available." appears on the TV screen, it means no subtitle is recorded on the scene.
- Some discs will only allow you to change the subtitle from the disc menu. Refer to the manual accompanying the discs for details.

## Audio Language



This unit allows you to Select an Audio Language **(if Multiple Languages are available on a Disc)** during DVD Playback.

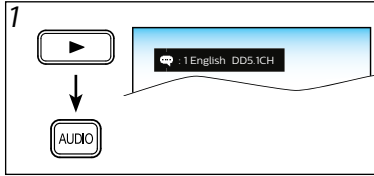

Each time you press **[AUDIO]**, Audio Language changes as example below.

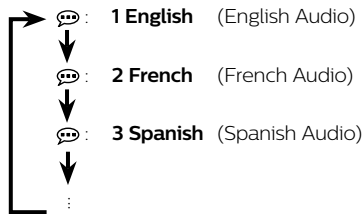

### Note(s):

- Some discs will only allow you to change the Audio Setting from the Disc Menu. Refer to the manual accompanying the discs for details.
- If your Language is not shown after pressing **[AUDIO]** several times, the disc may not have that language. However, some discs allow Audio Language Setting on the Disc Menu. (Operation varies depending on the disc, so refer to the manual accompanying the disc.)

## Camera Angles



Some DVD's may contain scenes which have been shot simultaneously from various angles. You can change the Camera Angle if  icon appears on the TV screen.

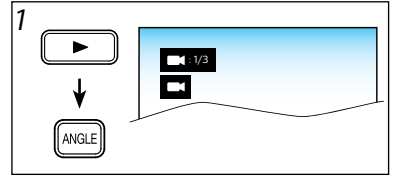

Each time you press **[ANGLE]**, camera angle changes.

# DVD Settings

You can change the Settings on the unit. Setting items are displayed in gray when they are not available under the conditions at the time.

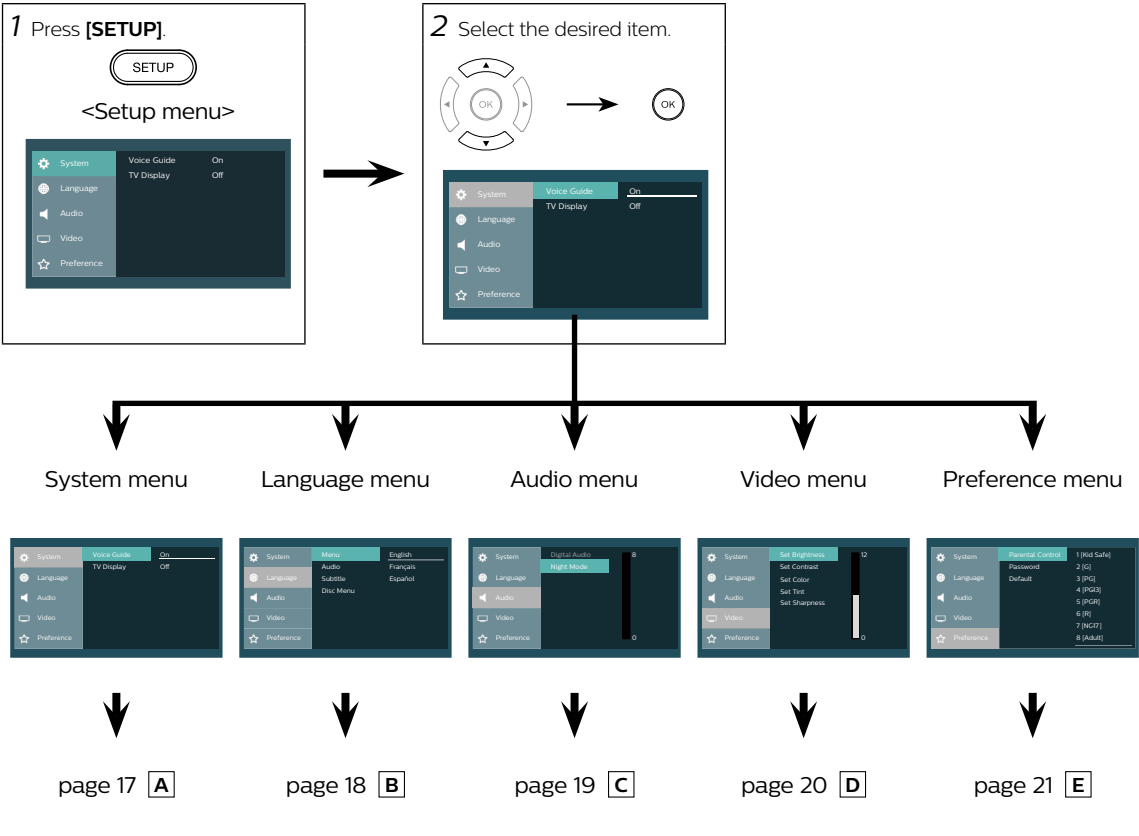



## A System Settings

You can change the Display functions. Follow steps 1 and 2 on page 16.

**3** Select the desired item.

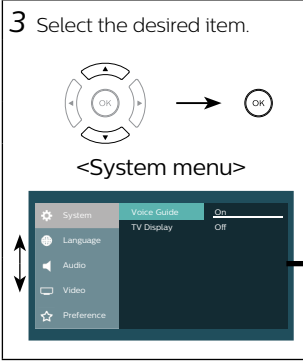

<System menu>

**4**

**Voice Guide: (Default: On)**  
Turns On/Off the Voice Guide function.



Select the Desired Setting.

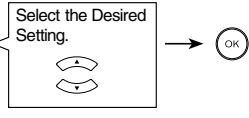

**TV Display: (Default: 16:9 Widescreen)**  
Sets the aspect ratio of the playback image to fit your TV. See the note on the right.

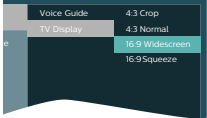

**5** To Exit the Menu



### Note(s):

#### TV Display:

- Select “4:3 Crop” for a full height picture with both sides adjusted.
- Select “4:3 Normal”, black bars may appear on the top and bottom of the TV screen.
- Select “16:9 Widescreen” if a wide-screen TV is connected to this unit.
- Select “16:9 Squeeze” to display 4:3 aspect ratio in the center of the 16:9 screen when playing back 4:3 images.

### Note:

#### Voice Guide:

- In order to enable the Voice Guide function, the OSD language needs to be set to English. Voice Guide is not available in French or Spanish.
- “Digital Audio” cannot be configured when Voice Guide is set to On, as it is fixed to PCM. In order to configuring the setting, set Voice Guide to Off.

**B****Language Settings**

Follow steps 1 and 2 on page 16.

**3** Select the desired item.

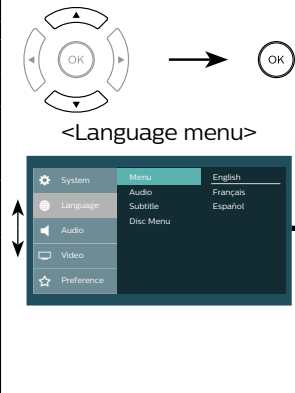

**4**

**Menu: (Default: English)**  
Sets the Language for the On-screen Display.



**Audio: (Default: English) \*1 \*2**  
Sets the Audio Language.



**Subtitle: (Default: Off) \*1 \*2**  
Sets the Subtitle Language.



**Disc Menu: (Default: English) \*1**  
Sets the Language in DVD Menu.



**5** To Exit the Menu

**Note(s):**

- \*1 · Language options are not available with some discs.
  - Only the Languages supported by the disc can be selected.
- \*2 “Language” setting for “Audio” and “Subtitle” are not available with some discs. If Multiple Languages are available on disc, then select **[AUDIO]** or **[SUBTITLE]** to select the desired Language. Refer to page 15 for detail.
- In order to enable the Voice Guide function, the OSD language needs to be set to English. Voice Guide is not available in French or Spanish.

Choose the appropriate Audio Settings for your device. It only affects the Sound during DVD Playback. Follow steps 1 and 2 on page 16.

**3** Select the desired item.

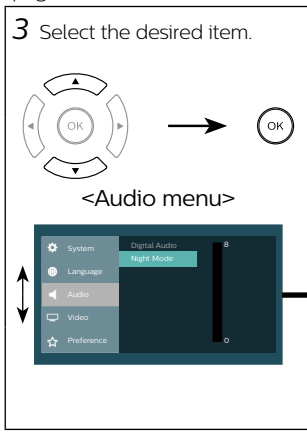

**4**

**Digital Audio: (Default: PCM)**  
Set to "Bitstream" when the unit is connected to a Dolby Digital decoder.  
– Bitstream: outputs a Dolby Digital signals.  
– PCM: convert the Dolby Digital into PCM (2 channel).



**Night Mode (Default: 0)**  
Adjusts for Clarity even when the Volume is Low, by Compressing the Range of the lowest sound level and the highest sound level.

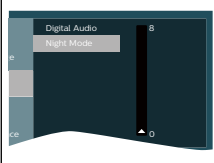

**5** To Exit the Menu



### Note(s):

#### Audio Out:

- Bitstream:  
Connecting to a Dolby Digital decoder for Dolby Digital Audio output.
- PCM:  
Connecting to another device (an MD deck or DAT deck etc.) without a Dolby Digital Decoder.  
Convert the Dolby Digital into LPCM (2 channel).
- This unit does not support DTS audio. This is not a malfunction.  
You need to set this unit to "Bitstream" in the "Audio Out" Menu and also need to Connect to a TV or Amplifier that supports DTS, then the audio will be output as DTS.  
It is only available when connected via a Coaxial cable.
- "Digital Audio" cannot be configured when Voice Guide is set to On, as it is fixed to PCM. In order to configuring the setting, set Voice Guide to Off.

**D****Video Settings**

You can change the Video functions. Follow steps 1 and 2 on page 16.

**3** Select the desired item.

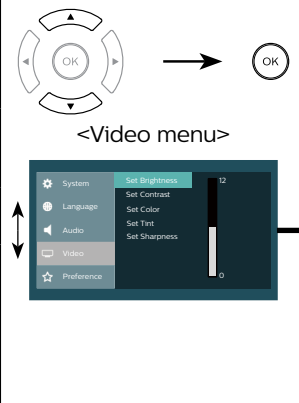

**4**

**Set Brightness (Default: 6)**  
Adjusts the Brightness.

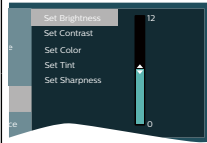

Adjust to the  
Desired Level.

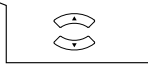

**Set Contrast (Default: 6)**  
Adjusts the Contrast.

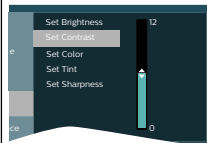

**Set Color (Default: 0)**  
Adjusts the Color Saturation.

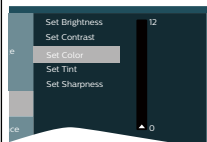

**Set Tint (Default: 0)**  
Adjusts the Color Tone.

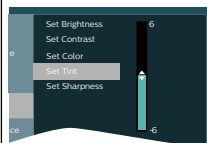

**Set Sharpness (Default: 0)**  
Adjusts the sharpness.

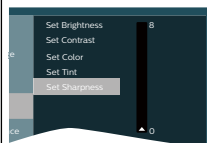

**5** To Exit the Menu

**Note(s):**

- The horizontal white bars indicate the default setting.
- The Settings will remain effective even if the unit is switched into the Standby mode.
- The effect of Picture Adjustment may differ depending on the connected TV.

You can change the Display functions. Follow steps 1 and 2 on page 16.

### 3 Select the desired item.

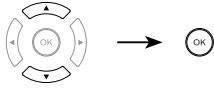

<Preference menu>

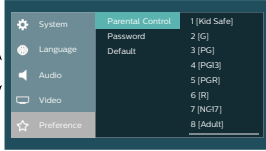

### 4

#### Parental Control: (Default: 8[Adult])

Sets the rating level for the disc playback. Rating settings allows you to set the rating levels of your DVD. Playback will stop if the ratings exceed the levels you set.

- The rating level can be changed when a password has not been set yet for the first time use.
- If you have set a password already, "Movie Rating" cannot be selected.

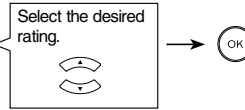
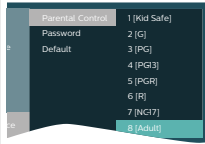

#### Password:

Sets the password for "Movie Rating" and "Default" settings.

- For the first time use.
- This number will be used as the password. Record in case you forget it.

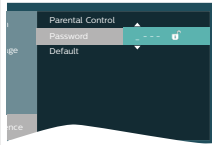

Enter any 4-digit number(except for 4737).

- Press cursor [▲] or [▼] to change the number, then press cursor [▶].
- Press cursor [◀] to erase if you input the incorrect number.
- When 4-digit numbers are entered, press [OK].

– A password has been set already. (🔒 is displayed.)

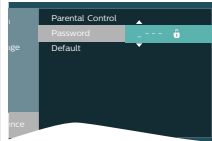

Enter your 4-digit password.

- Press cursor [▲] or [▼] to change the number, then press cursor [▶].
- When 4-digit numbers are entered, press [OK].

#### Default:

Reset to default setting.

- "Default" is not selected if you have set a password already.

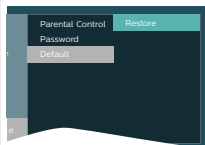

### 5 To Exit the Menu



#### Note(s):

##### Password:

- If you forget the password, enter "4737" at step 4, then enter your new password.
- Playback will stop if the ratings exceed the levels you set, it will require you to enter a password before the disc will play back.
- This function is available only when 🔒 is displayed.

##### Default:

- When you do not wish to initialize, press [SETUP] to exit the menu at step 4.

# INFORMATION

## Troubleshooting Guide

If the Unit does not perform properly when operated as instructed in this Owner's Manual, refer to the following.

Problem	Corrective action
<b>No Power.</b>	<ul style="list-style-type: none"> <li>– Check if the AC Power cord is properly connected.</li> <li>– Unplug from the AC outlet, and wait for 5-10 seconds and then Plug it in again.</li> </ul>
<b>No Sound or Picture.</b>	<ul style="list-style-type: none"> <li>– Check if the TV is switched On.</li> <li>– Check the Video Connection.</li> <li>– Check the Audio/Video Cable connections to the TV. (Refer to page 8.)</li> </ul>
<b>Distorted Picture.</b>	<ul style="list-style-type: none"> <li>– Sometimes a small amount of Picture Distortion may appear. This is Not a Malfunction.</li> <li>– Connect the unit directly to the TV.</li> </ul>
<b>Completely Distorted Picture or Black/White Picture with DVD.</b>	<ul style="list-style-type: none"> <li>– Connect this unit directly to the TV.</li> <li>– Make sure the Disc is Compatible with the unit.</li> </ul>
<b>No Sound or Distorted Sound.</b>	<ul style="list-style-type: none"> <li>– Adjust the Volume.</li> <li>– Check that the Speakers are Connected correctly.</li> </ul>
<b>No DTS Audio is Output.</b>	<ul style="list-style-type: none"> <li>– This unit does Not support DTS Audio. This is Not a Malfunction.</li> <li>– You need to set this unit to "Bitstream" in "Audio Out" Menu and also need to connect to the TV or Amplifier that supports DTS, then the Audio will be output as DTS. It is only available when connected via a Coaxial cable.</li> <li>– "Digital Audio" cannot be configured when Voice Guide is set to On. In order to set "Digital Audio" to "Bitstream", set Voice Guide to Off.</li> </ul>
<b>Bitstream is not output in Dolby Digital audio.</b>	<ul style="list-style-type: none"> <li>– Make sure that "Voice Guide" is set to "Off". "Digital Audio" is fixed to "PCM" when "Voice Guide" is set to "On". In order to set "Digital Audio" to "Bitstream", set "Voice Guide" to "Off".</li> </ul>
<b>Picture Freezes Momentarily during Playback.</b>	<ul style="list-style-type: none"> <li>– Check the Disc for Fingerprints/Dirty and Clean with a Soft cloth wiping from center to edge.</li> </ul>
<b>Disc Cannot be Played back.</b>	<ul style="list-style-type: none"> <li>– Clean the Disc.</li> <li>– Ensure the Disc is inserted in Correct position.</li> <li>– Insert a Correct Type disc that Plays back on this unit.</li> <li>– Check if the Disc is defective by trying another disc.</li> <li>– Check if the Parental settings exceeds the levels you set in the "Movie Rating" setting. (for DVD only)</li> <li>– Handle a Disc with special care so that it does not have Fingerprints, Scratches, or Dust on its surface.</li> </ul>
<b>No Return to Start-up Screen when Disc is Removed.</b>	<ul style="list-style-type: none"> <li>– Turn Off the unit once and then restart.</li> </ul>
<b>The Unit does not Respond to the Remote Control.</b>	<ul style="list-style-type: none"> <li>– Aim the Remote Control Directly at the Sensor on the Front Panel.</li> <li>– Reduce the Distance to the unit.</li> <li>– Re-insert the Batteries with their Polarities (+/- signs) as indicated.</li> <li>– Replace the Batteries in the Remote Control.</li> <li>– Press and Hold any buttons on the Remote Control toward a Digital Camera. The Remote Control is working if you confirm a pulsating infrared light through the Digital Camera.</li> </ul>
<b>Buttons Do Not Work or the Unit Stops Responding.</b>	<ul style="list-style-type: none"> <li>– Please attempt to Reset the unit by Unplugging the AC Power cord from the Wall outlet and then Plug it in again after 5-10 seconds.</li> </ul>
<b>The Unit Does Not Respond to some Operating Commands during Playback.</b>	<ul style="list-style-type: none"> <li>– Operations may Not be permitted by the Disc. Refer to the instructions for the disc.</li> </ul>
<b>The Unit Cannot Read CD / DVD.</b>	<ul style="list-style-type: none"> <li>– Use a commonly available Cleaning CD / DVD disc to Clean the Lens before sending the Unit for Repair.</li> </ul>
<b>Angle Does Not Switch.</b>	<ul style="list-style-type: none"> <li>– The Angle cannot be switched for a DVD which does not contain Multiple Angles. In some cases Multiple Angles are only recorded for specific Scenes.</li> </ul>
<b>The Password for Rating Level has been Forgotten.</b>	<ul style="list-style-type: none"> <li>– Enter the Default Password "4737", then your Forgotten Password will be Cleared. Then the Rating Level plus Password will have to be set again.</li> </ul>

- Some Functions are not available in Specific modes, but this is Not a Malfunction. Read the description in this Owner's Manual for more details on Correct Operation's.
- Not all Functions are available for all Commercial discs.

## Specifications

### Output Signal Format:

NTSC color

### Power Source:

120V AC +/- 10%, 60Hz +/- 0.5%

### Power Consumption:

7 W (standby : 0.9 W)

### Operating Temperature:

41°F (5°C) to 104°F (40°C)

### Dimensions:

W : 9.9 inches (250 mm)  
H : 2.0 inches (50.2 mm)  
D : 7.4 inches (187.7 mm)

### Weight:

Approx. 1.95 lbs. (0.88 kg)

- Designs and Specifications are subject to change without notice.
- If there is a Discrepancy between Languages, the default Language will be English.

# NINETY (90) DAY LIMITED WARRANTY

## WARRANTY COVERAGE:

This warranty obligation is limited to the terms as set forth below.

## WHO IS COVERED:

This product is warranted to the original purchaser or the person receiving the product as a gift against defects in materials and workmanship as based on the date of original purchase ("Warranty Period") from an Authorized Dealer. The original sales receipt showing the product name and the purchase date from an authorized retailer is considered such proof.

## WHAT IS COVERED:

This warranty covers new products if a defect in material or workmanship occurs and a valid claim is received within the Warranty Period. At its option, the company will either (1) repair the product at no charge, using new or refurbished replacement parts, or (2) exchange the product with a product that is new or which has been manufactured from new, or serviceable used parts and is at least functionally equivalent or most comparable to the original product in current inventory, or (3) refund the original purchase price of the product.

The Company warrants replacement products or parts provided under this warranty against defects in materials and workmanship from the date of the replacement or repair for ninety (90) days or for the remaining portion of the original product's warranty, whichever provides longer coverage for you. When a product or part is exchanged, any replacement item becomes your property and the replaced item becomes the company's property. When a refund is given, your product becomes the company's property.

**Note: Any product sold and identified as refurbished or renewed carries a ninety (90) day limited warranty. Replacement product can only be sent if all warranty requirements are met. Failure to follow all requirements can result in delay.**

## WHAT IS NOT COVERED - EXCLUSIONS AND LIMITATIONS:

This Limited Warranty applies only to new company manufactured products that can be identified by the trademark, trade name, or logo affixed to it. This Limited Warranty does not apply to any hardware product or any software, even if packaged or sold with the product, as manufacturers, suppliers, or publishers may provide a separate warranty for their own products packaged with the bundled product. The company is not liable for any damage to or loss of any programs, data, or other information stored on any media contained within the product, or other additional product or part not covered by this warranty. Recovery or reinstallation of programs, data or other information is not covered under this Limited Warranty. This warranty does not apply (a) to damage caused by accident, abuse, misuse, neglect, misapplication, or non-supplied product, (b) to damage caused by service performed by anyone other than

company approved Authorized Service Location, (c) to a product or a part that has been modified without written company permission, or (d) if any serial number has been removed or defaced, or (e) product, accessories or consumables sold "AS IS" without warranty of any kind by including refurbished product sold "AS IS" by some retailers.

## This Limited Warranty does not cover:

- Shipping charges to return defective product.
- Labor charges for installation or setup of the product, adjustment of customer controls on the product, and installation or repair of antenna/signal source systems outside of the product.
- Product repair and/or part replacement because of improper installation or maintenance, connections to improper voltage supply, power line surge, lightning damage, retained images or screen markings resulting from viewing fixed stationary content for extended periods, product cosmetic appearance items due to normal wear and tear, unauthorized repair or other cause not within the control of the company.
- Damage or claims for products not being available for use, or for lost data or lost software.
- Damage from mishandled shipments or transit accidents when returning product.
- A product that requires modification or adaptation to enable it to operate in any country other than the country for which it was designed, manufactured, approved and/or authorized, or repair of products damaged by these modifications.
- A product used for commercial or institutional purposes (including but not limited to rental purposes).
- Product lost in shipment and no signature verification receipt can be provided.
- Failure to operate per Owner's Manual.

## TO OBTAIN ASSISTANCE...

Contact Customer Care Center at:  
1-866-515-1124

REPAIR OR REPLACEMENT AS PROVIDED UNDER THIS WARRANTY IS THE EXCLUSIVE REMEDY FOR THE CONSUMER, WITH THE ISSUING COMPANY NOT LIABLE FOR ANY INCIDENTAL OR CONSEQUENTIAL DAMAGES FOR BREACH OF ANY EXPRESS OR IMPLIED WARRANTY ON THIS PRODUCT. EXCEPT TO THE EXTENT PROHIBITED BY APPLICABLE LAW, ANY IMPLIED WARRANTY OF MERCHANTABILITY OR FITNESS FOR A PARTICULAR PURPOSE ON THIS PRODUCT IS LIMITED IN DURATION TO THE DURATION OF THIS WARRANTY.

Some states do not allow the exclusions or limitation of incidental or consequential damages, or allow limitations on how long an implied warranty lasts, so the above limitations or exclusions may not apply to you.

This warranty gives you specific legal rights. You may have other rights which vary from state/province to state/province.

P&F USA, Inc.

1880 Braselton Hwy, Suite 118 #5012 Lawrenceville, GA 30043



P&F USA, Inc.  
1880 Braselton Hwy, Suite 118 #5012 Lawrenceville, GA 30043

P&F Mexicana, S.A. de C.V.  
Av. La Palma No. 6, Col. San Fernando La Herradura.  
Huixquilucan, Edo. de México. C.P. 52787

This product has been manufactured by and is sold under the responsibility of P&F USA, Inc., and P&F USA, Inc. is the warrantor in relation to this product.

The Philips trademark and the Philips Shield Emblem are registered trademarks of Koninklijke Philips N.V. used under license.

E6T20UL  
★★★★★