



Shenzhen Yunyue Intelligent Technology Co., Ltd.

Address: 11th Floor, Block B, Tsinghua Info Port. No.1 Xindong Road, Songpingshan, Songpingshan Community, Xili Street, Nanshan District, Shenzhen

Philips and the Philips Shield Emblem are registered trademarks of Koninklijke Philips N.V. and are used under license.

This product has been manufactured by and is sold under the responsibility of Shenzhen Yunyue Intelligent Technology Co., Ltd. and Shenzhen Yunyue Intelligent Technology Co., Ltd. is the warrantor of this product.

© 2021 Koninklijke Philips N.V. All rights reserved. Philips smart safe box reserves the rights to change content and product specifications included in this user manual without prior notice at any time.

Version: 1.0

PHILIPS

7000 Series

Smart safe box

SBX702

User manual



To register your product as well as obtain support, please go to:
www.philips.com/support

Models	Outside dimensions (HxWxD)	Weight
FDG-A10/D-100-SBX702-AB0	1000x600x520 mm	194.0 kg
FDG-A10/D-100-SBX702-ABX	1000x600x520 mm	196.0 kg
FDG-A10/D-120-SBX702-CB0	1200x630x550 mm	232.0 kg
FDG-A10/D-120-SBX702-CBX	1200x630x550 mm	234.0 kg

Please read this user manual carefully before using this product.

Thank you for purchasing Philips-branded products. For your safety, please read this user manual carefully before using the product. Any personal injury, property or other loss caused by not following the user manual or precautions, no liability will be assumed by Philips.

Kind reminder:

This user manual is used as a guide. The photos, pictures, or illustrations provided in the manual are for explanation purposes, which may differ from the specific product, please refer to the actual product. Due to product version upgrade or other needs, Philips may update this manual timely without notice. If you need the latest version of the manual, please download it from the Philips website (www.philips.com/support). The copyright of any part from this manual, including text, pictures or illustrations, belongs to Philips. Without written permission, no corporation or individual may extract, copy, translate, or modify all or part of this manual in any way. Unless otherwise agreed, Philips does not make any express or implied representations and guarantees.

Get to know your smart safe box	01
Keypad	03
First use	04
Register fingerprint and PIN code.....	05
Delete fingerprint and PIN code	06
Safe mode	07
Language setting	08
Back-up system	08
Vibrant alert	09
False alert	10
Low-voltage alert	10
Watch winder	11
Wall-mount instructions	12
After-sales policies	13
After-sales support	14
Warranty card	15

Get to know your smart safe box

1. Keypad
2. Handle
3. Door
4. Feet
5. Watch winder
6. Drawer
7. Compartment
8. Watch winder control switch
9. Battery compartment
10. Locking bolt

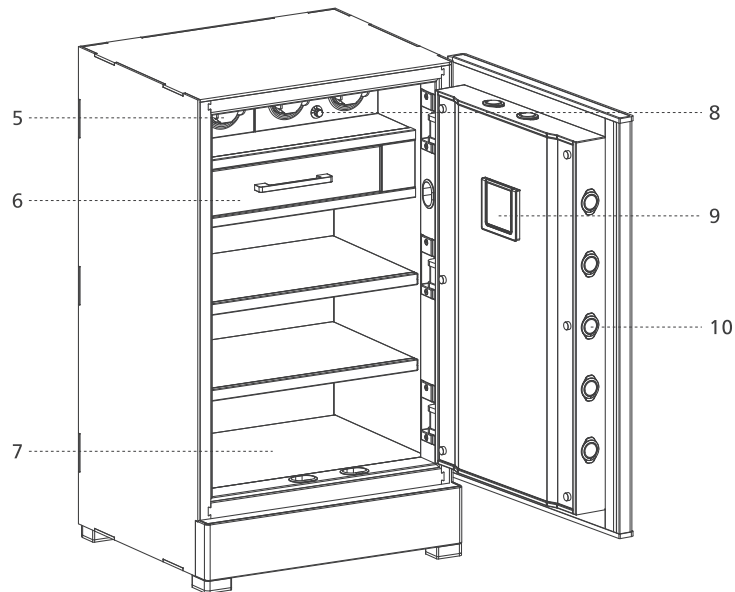
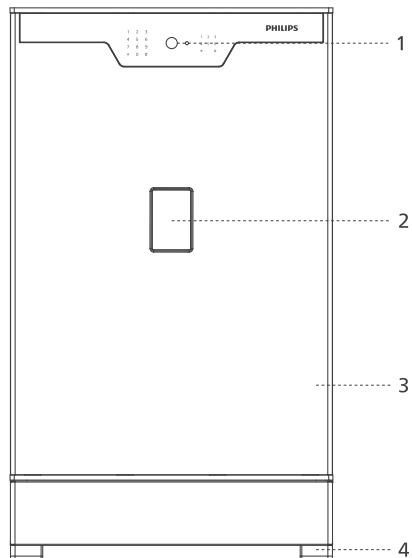

Keypad

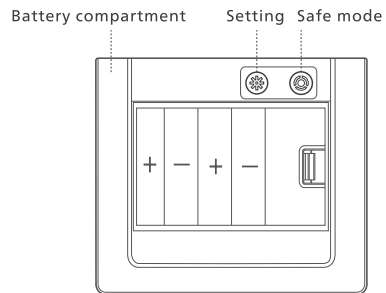
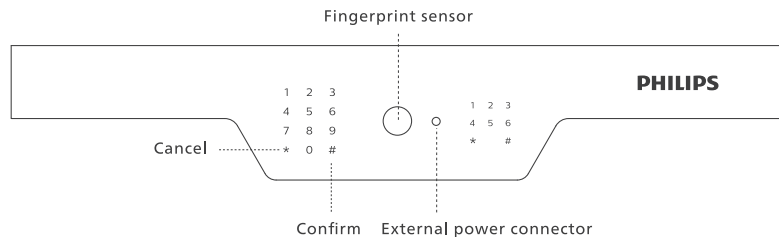

First use

1. Insert 4 AA batteries into the external power supply box, then plug the power into the connector interface beside the infrared sensor.
2. As shown in Figure 1, enter any fingerprint or simply touch the panel to wake up the keypad. Enter default password "1234" and press "#" to confirm. After hearing a voice prompt "Unlocking successful", open battery compartment inside the safe and insert in 4 AA batteries to complete the first use.

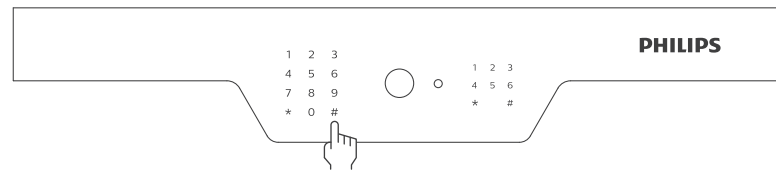

Figure 1

⚠ Attention:

Do not place the external power box inside the safe! Besides powering up the safe for its first use, it is also for emergency use when the main power supply is down.

Register fingerprint and PIN code

1. Open safe door and press "🔊" on the battery compartment. After hearing a voice prompt "Please enter fingerprint or PIN code", enter your fingerprint as shown in Figure 2. A voice prompt "Fingerprint entering succeeded." indicates successful operation. If the entering fails, there will be a voice prompt "Fingerprint entering failed". The system will automatically exit if there is no entering in 8 seconds.

⚠ Attention: this product supports a maximum of 30 fingerprints.

2. After the fingerprint is successfully entered, you can continue with PIN code entering. Enter a string of 3 - 8 digit PIN code and press "#" to confirm. There will be a voice prompt "Please enter your PIN code again". Enter the PIN code again and press "#" to confirm. There will be a voice prompt "PIN code setting successful", indicating successful operation.

⚠ Attention: this product supports a maximum of 10 sets of PIN codes.

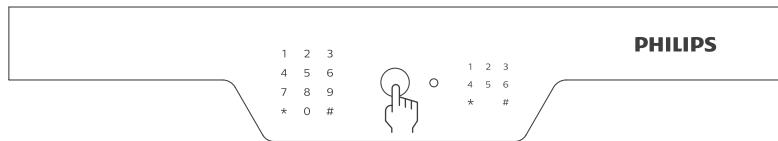

Figure 2

Delete fingerprint and PIN code

As shown in Figure 3, press "🔊" on the battery compartment for 3 seconds. There will be a voice prompt "Initialization successful", indicating all PIN codes and fingerprints have been successfully deleted and the safe has restored to factory settings.

⚠ Attention:

1. This product does not support deleting single fingerprint or PIN code.
2. After restoring to factory settings, "Vibration alert" and "Safe mode" will also return to the initial settings (off).

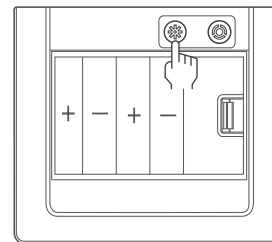



Figure 3

Safe mode

1. Under "Safe mode", 2 registered codes are required to unlock the safe, either "fingerprint + fingerprint", "fingerprint + password", "password + fingerprint" or "password + password".
 2. As shown in Figure 4, press "  " on the battery compartment and there will be a voice prompt "Safe mode is on", indicating successful activation. Press the button again can turn "Safe mode" off.
-  Attention: under "Standard mode", any one set of registered PIN code or fingerprint can unlock the safe.

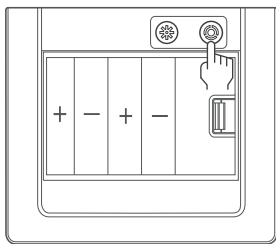



Figure 4

Language setting

Press the "  " button on the battery compartment, insert batteries, and hold until hearing a beep. Press the button 4 times can switch between Chinese and English.

 Attention: the default language is Chinese.

Back-up system

This product is designed with back-up system. The main system is used under normal situations. The back-up system is used in case the main system breaks down or the registered fingerprints and passwords fail to open the safe.

 Attention:

1. For security concern, we do not disclose the methods of using the back-up system. Please contact us for instruction if the main system of your safe breaks down.
2. Do not place the external power box inside the safe! It is needed for starting the back-up system.

Vibrant alert

1. As shown in Figure 5, press "Ⓜ" for 3 seconds. There will be a voice prompt "Vibration alert is on", indicating successful operation. Press the same button for another 3 seconds can turn the "Vibration alert" off.
2. When the safe detects a certain intensity of vibration, it will activate vibration alert. The alert will last for 20 seconds and can be stopped by any registered fingerprint or password.

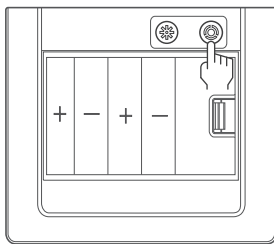

Figure 5

False alert

5 times of wrong fingerprint entering or 3 times of wrong password entering will activate false alert. The alert will last for 20 seconds. At the same time, the system will be locked for 180 seconds.

⚠ Attention: safe can not be operated under "Locked" state caused by false alert.

Low-voltage alert

If voltage of the main power supply goes below 4.8 V, the system will activate "Low-voltage alert". In using the safe, it will remind you with a voice prompt "Low voltage, please replace battery". Once having this alert, please replace battery in time.

⚠ Attention: Low-voltage may affect the normal use of the safe. Please replace battery in time when receiving low-voltage alert.

Watch winder display modes

Figure 6 is an illustration of the control switch of watch winder.

- OFF mode.
- Mode 1: Clockwise for 2 minutes, stop for 6 minutes; repeat.
- Mode 2: Counterclockwise for 2 minutes, stop for 6 minutes; repeat.
- Mode 3: Clockwise for 2 minutes, stop for 6 minutes; Counterclockwise for 2 minutes, stop for 6 minutes; repeat.
- Mode 4: Clockwise for 5 minutes, stop for 5 minutes; repeat for 3 hours, stop for 9 hours.

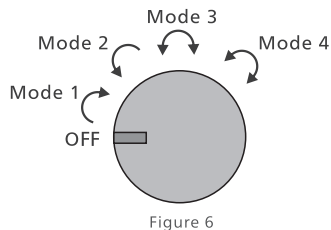

⚠ Attention:

1. This function is optional and only available for the "Network Edition" products.
2. If you are using "Network Edition" products, please scan QR code below to download APP and get tutorial.

Wall-mount instructions

As shown in Figure 6, select an appropriate installation position, then open the safe door and take out the plugs on the back panel. Mark hole positions on the wall or cabinet and drill holes for expansion tubes. Put expansion tubes in the holes, then attach the safe and fix it with screws.

⚠ Attention:

1. Concrete wall is recommended for mounting the safe.
2. For safety reasons, please make sure the safe is firmly attached to the wall.

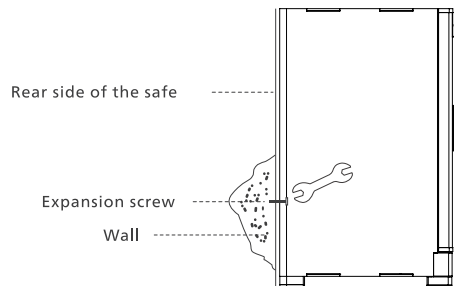

Figure 7

After-sales policy

Philips smart safe box warrants:

1. Return or replacement of products that have defects caused by non-human factors or force majeure within 7 days from the date of purchase;
2. Replacement or maintenance of products that have defects caused by non-human factors or force majeure within 8-15 days from the date of purchase;
3. Maintenance of products that have defects caused by non-human factors or force majeure within 24 months from the date of purchase;

This warranty does not apply to (including but not limited to):

1. Damages of product caused by unauthorized repairs, misuse, incorrect use, abuse, collision, negligence, fluid intake, accidents, modification and alterations;
2. Products with broken or altered labels, serial number and anti-counterfeit label;
3. Products out of warranty period;
4. Damages caused by force majeure;
5. Damages due to human factors.

After-sales support

If you encounter any problems when using the product, please contact local authorized distributors.

Warranty card

Model of product		Serial number of product	
Invoice No.		Seller	
Address of seller			
Date of sales		User name	
Contact of user		Address of user	
Failure description			
Maintenance records	Date	Issue	Maintenance staff
		User signature	