

User Manual	6
Manuel D'utilisation	42
Manual de usuario	78



Thank you for choosing Philips.

Need help fast?

Read your Quick Start Guide and/or User Manual first for quick tips that make using your Philips product more enjoyable.

Register your product and get support at
www.philips.com/welcome
 or call
1 886 771 4018
while with your product
(and Model / Serial number)



Philips vous remercie de votre confiance.

Besoin d'une aide rapide?

Le Guide rapide de début et Manuel de l'utilisateur regorgent d'astuces destinées à simplifier l'utilisation de votre produit Philips.

Enregistrez votre produit et accédez à l'assistance sur
www.philips.com/welcome
 ou formez le
1 800 661 6162 (Francophone)
1 866 771 4018 (English speaking)

Veillez à avoir votre produit à portée de main
(et model / serial nombre)



Gracias por escoger Philips

Necesita ayuda inmediata?

Lea primero la Guía rápida del comienzo o el Manual del usuario, en donde encontrará consejos que le ayudarán a disfrutar plenamente de su producto Philips.

Visite
www.philips.com/welcome
para registrar su producto y obtener información de contacto y asistencia.

o llame al teléfono
1 866 771 4018
y tenga a mano el producto
(y número de model / serial)



**Return your Product Registration Card or register online at
www.philips.com/welcome today to get the very most from your purchase.**

Registering your model with PHILIPS makes you eligible for all of the valuable benefits listed below, so don't miss out. Complete and return your Product Registration Card at once, or register online at www.philips.com/welcome to ensure:

***Proof of Purchase**

Returning the enclosed card guarantees that your date of purchase will be on file, so no additional paperwork will be required from you to obtain warranty service.

***Product Safety Notification**

By registering your product, you'll receive notification - directly from the manufacturer - in the rare case of a product recall or safety defect.

***Additional Benefits**

Registering your product guarantees that you'll receive all of the privileges to which you're entitled, including special money-saving offers.

PHILIPS

Congratulations on your purchase, and welcome to the "family!"

Dear PHILIPS product owner:

Thank you for your confidence in PHILIPS. You've selected one of the best-built, best-backed products available today. We'll do everything in our power to keep you happy with your purchase for many years to come.

As a member of the PHILIPS "family," you're entitled to protection by one of the most comprehensive warranties and outstanding service networks in the industry. What's more, your purchase guarantees you'll receive all the information and special offers for which you qualify, plus easy access to accessories from our convenient home shopping network.

Most importantly, you can count on our uncompromising commitment to your total satisfaction.

All of this is our way of saying welcome - and thanks for investing in a PHILIPS product.

**P.S. To get the most from your PHILIPS purchase, be sure to complete and return your Product Registration Card at once, or register online at:
www.philips.com/welcome**

Know these **safety** symbols



⚡ This "bolt of lightning" indicates uninsulated material within your unit may cause an electrical shock. For the safety of everyone in your household, please do not remove product covering.

! The "exclamation point" calls attention to features for which you should read the enclosed literature closely to prevent operating and maintenance problems.

WARNING: To reduce the risk of fire or electric shock, this apparatus should not be exposed to rain or moisture and objects filled with liquids, such as vases, should not be placed on this apparatus.

CAUTION: To prevent electric shock, match wide blade of plug to wide slot, fully insert.

ATTENTION: Pour éviter les choc électriques, introduire la lame la plus large de la fiche dans la borne correspondante de la prise et pousser jusqu'au fond.

For Customer Use

Enter below the Serial No. which is located on the rear of the cabinet. Retain this information for future reference.

Model No. _____
Serial No. _____

PHILIPS

Visit our World Wide Web Site at <http://www.philips.com/welcome>

Ensure that the power outlet is always within reach. If abnormal situations occur, fully disconnect power: unplug the power cord from the power outlet.

IMPORTANT SAFETY INSTRUCTIONS

1. Read these instructions.
2. Keep these instructions.
3. Heed all warnings.
4. Follow all instructions.
5. Do not use this apparatus near water.
6. Clean only with dry cloth.
7. Do not block any ventilation openings. Install in accordance with the manufacturer's instructions.
8. Do not install near any heat sources such as radiators, heat registers, stoves, or other apparatus (including amplifiers) that produce heat.
9. Do not defeat the safety purpose of the polarized or grounding-type plug. A polarized plug has two blades with one wider than the other; A grounding type plug has two blades and a third grounding prong. The wide blade or the third prong are provided for your safety. If the provided plug does not fit into your outlet, consult an electrician for replacement of the obsolete outlet.
10. Protect the power cord from being walked on or pinched, particularly at plugs, convenience receptacles, and the point where they exit from the apparatus.
11. Only use attachments/accessories specified by the manufacturer:

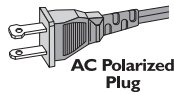

12.  Use only with the cart, stand, tripod, bracket, or table specified by the manufacturer or sold with the apparatus. When a cart is used, use caution when moving the cart/apparatus combination to avoid injury from tip-over.

13. Unplug this apparatus during lightning storms or when unused for long periods of time.

14. Refer all servicing to qualified service personnel. Servicing is required when the apparatus has been damaged in any way, such as power-supply cord or plug is damaged, liquid has been spilled or objects have fallen into the apparatus, the apparatus has been exposed to rain or moisture, does not operate normally, or has been dropped.

15. Battery usage **CAUTION** – To prevent battery leakage which may result in bodily injury, property damage, or damage to the unit:

- Install all batteries correctly, + and - as marked on the unit.
- Do not mix batteries (old and new or carbon and alkaline, etc.).
- Remove batteries when the unit is not used for a long time.

16. Apparatus shall not be exposed to dripping or splashing.

17. Do not place any sources of danger on the apparatus (e.g. liquid filled objects, lighted candles).

18. This product may contain lead and mercury. Disposal of these materials may be regulated due to environmental considerations. **For disposal or recycling information, please contact your local authorities or the Electronic Industries Alliance : www.eiae.org.**

Class II equipment symbol

This symbol indicates that the unit has a double insulation system

EL 6475-E005: 04/01

This warning label is located on the rearside and inside this laser product.

CAUTION INVISIBLE LASER RADIATION
WHEN OPEN, DO NOT STARE INTO BEAM.
DANGER INVISIBLE LASER RADIATION WHEN OPEN
AVOID DIRECT EXPOSURE TO BEAM.
VARO! AVATTIENNA JA SUOJALLUKITUS OHITETTÄESSÄ OLET
ALTTI UMMAAN SYNTYMÄLLE LASERSÄTEILYLLE. ÄLÄ
KATSO SÄTEESEEN.
WARNING! COGNIBLE LASERSTRÅLNING NÄR DENNA DEL ÄR ÖPPNAD.
ÖCH SNIPPEN ÄR LINGOPLACERAD I STRÅLEN.

or

DANGER - Invisible laser radiation when open.
AVOID DIRECT EXPOSURE TO BEAM.

WARNING

*To reduce the risk of fire or electric shock,
do not expose this equipment to rain or
moisture.*

*Use of controls or adjustments or
performance of procedures other than
herein may result in hazardous radiation
exposure.*

*The set complies with the FCC-Rules, Part B
15 and with 21 CFR 1040.10.*

ATTENTION

*L'utilisation des commandes ou
réglages ou le non-respect des
procédures ci-incluses peuvent se
traduire par une exposition
dangereuse à l'irradiation.*

ATENCIÓN

*El uso de mando o ajustes o la
ejecución de métodos que no sean
los aquí descritos puede ocasionar
peligro de exposición a radiación.*

Canada

English:

This digital apparatus does not exceed the Class B limits for radio noise emissions from digital apparatus as set out in the Radio Interference Regulations of the Canadian Department of Communications.

Français:

Cet appareil numérique n'émet pas de bruits radioélectriques dépassant les limites applicables aux appareils numériques de Class B prescrites dans le Règlement sur le Brouillage Radioélectrique édicté par le Ministère des Communications du Canada.

English ----- 6

Français ----- 42

Español ----- 78

English

Français

Español

Philips and Philips Shield are used under license of Koninklijke Philips Electronics NV

Declaration of Conformity

Model number: DVP1013
Trade Name: Philips
Responsible Party: Philips Consumer Lifestyle
A Division of Philips Electronics
North America Corp.
P.O. Box 671539
Marietta, GA 30006-0026

Where the MAINS plug or an appliance coupler is used as the disconnect device, the disconnect device shall remain readily operable.

The apparatus shall not be exposed to dripping or splashing and that no objects filled with liquids, such as vases, shall be placed on apparatus.

Due to the inconsistency of disc formats provided by various disc manufacturers, your DVD system may require a playability enhancement or upgrade. As DVD technology advances, these enhancements will become common and will be easy to complete.
Go to www.philips.com/support for software upgrade.

This product incorporates copyright protection technology that is protected by method claims of certain U.S. patents and other intellectual property rights owned by Macrovision Corporation and other rights owners. Use of this copyright protection technology must be authorized by Macrovision Corporation, and is intended for home and other limited viewing uses only unless otherwise authorized by Macrovision Corporation. Reverse engineering or disassembly is prohibited.

'CONSUMERS SHOULD NOTE THAT NOT ALL HIGH DEFINITION TELEVISION SETS ARE FULLY COMPATIBLE WITH THIS PRODUCT AND MAY CAUSE ARTIFACTS TO BE DISPLAYED IN THE PICTURE. IN CASE OF 525 OR 625 PROGRESSIVE SCAN PICTURE PROBLEMS, IT IS RECOMMENDED THAT THE USER SWITCH THE CONNECTION TO THE 'STANDARD DEFINITION' OUTPUT. IF THERE ARE QUESTIONS REGARDING TV SET COMPATIBILITY WITH THIS MODEL 525p AND 625p DVD PLAYER, PLEASE CONTACT OUR CUSTOMER SERVICE CENTER.'

General Information

Environmental Information

All unnecessary packaging has been omitted. The packaging has been made easy to separate into two materials; cardboard (box) and polyethylene (bags, protective foam sheet).

Your DVD player consists of materials which can be recycled and reused if disassembled by a specialised company. Please observe the local regulations regarding the disposal of packaging materials, exhausted batteries and old equipment.



Manufactured under license from Dolby Laboratories. Dolby and the double-D symbol are trademarks of Dolby Laboratories.



Windows Media and the Windows logo are trademarks, or registered trademarks of Microsoft Corporation in the United States and/or other countries.

For Customer Use:
Read carefully the information located at the bottom or rear of your DVD Video player and enter below the Serial No. Retain this information for future reference.

Model No. DVP 1013
Serial No. _____

Laser Safety

This unit employs a laser. Due to possible eye injury, only a qualified service person should remove the cover or attempt to service this device.

NOTE:

Pictures shown maybe different between countries.

CAUTION:

WARNING LOCATION: ON THE BACKPLATE OF THE SET

NEVER MAKE OR CHANGE CONNECTIONS WITH THE POWER SWITCHED ON.

Specifications are subject to change without notice. Trademarks are the property of Koninklijke Philips Electronics N.V. or their respective owners.

LASER

Type	Semiconductor laser InGaAlP (DVD) AlGaAs (CD)
Wave length	658 nm (DVD) 790 nm (CD)
Output Power	7.0 mW (DVD) 10.0 mW (VCD/CD)
Beam divergence	60 degrees

Language Code

Abkhazian	6566	Inupiaq	7375	Pushto	8083
Afar	6565	Irish	7165	Russian	8285
Afrikaans	6570	Íslenska	7383	Quechua	8185
Amharic	6577	Italiano	7384	Raeto-Romance	8277
Arabic	6582	Ivrit	7269	Romanian	8279
Armenian	7289	Japanese	7465	Rundi	8278
Assamese	6583	Javanese	7486	Samoan	8377
Avestan	6569	Kalaallisut	7576	Sango	8371
Aymara	6589	Kannada	7578	Sanskrit	8365
Azerhijani	6590	Kashmiri	7583	Sardinian	8367
Bahasa Melayu	7783	Kazakh	7575	Serbian	8382
Bashkir	6665	Kernewek	7587	Shona	8378
Belarusian	6669	Khmer	7577	Shqip	8381
Bengali	6678	Kinyarwanda	8287	Sindhi	8368
Bihari	6672	Kirghiz	7589	Sinhalese	8373
Bislama	6673	Komi	7586	Slovensky	8373
Bokmål, Norwegian	7866	Korean	7579	Slovenian	8376
Bosanski	6683	Kuanyama; Kwanyama	7574	Somali	8379
Brezhoneg	6682	Kurdish	7585	Sotho; Southern	8384
Bulgarian	6671	Lao	7679	South Ndebele	7882
Burmese	7789	Latina	7665	Sundanese	8385
Castellano, Español	6983	Latvian	7686	Suomi	7073
Catalán	6765	Letzeburgesch;	7666	Swahili	8387
Chamorro	6772	Limburgan; Limburger	7673	Swati	8383
Chechen	6769	Lingala	7678	Svenska	8386
Chewa; Chichewa; Nyanja	7889	Lithuanian	7684	Tagalog	8476
中文	9072	Luxembourgish;	7666	Tahitian	8489
Chuang; Zhuang	9065	Macedonian	7775	Tajik	8471
Church Slavik; Slavonic	6785	Malagasy	7771	Tamil	8465
Chuvash	6786	Magyar	7285	Tatar	8484
Corsican	6779	Malayalam	7776	Telugu	8469
Česky	6783	Maltese	7784	Thai	8472
Dansk	6865	Manx	7186	Tibetan	6679
Deutsch	6869	Maori	7773	Tigrinya	8473
Dzongkha	6890	Marathi	7782	Tonga (Tonga Islands)	8479
English	6978	Marshallese	7772	Tsonga	8483
Esperanto	6979	Moldavian	7779	Tswana	8478
Estonian	6984	Mongolian	7778	Türkçe	8482
Euskara	6985	Nauru	7865	Turkmen	8475
Ελληνικά	6976	Navaho; Navajo	7886	Twi	8487
Faroese	7079	Ndebele, North	7868	Uighur	8571
Français	7082	Ndebele, South	7882	Ukrainian	8575
Frysk	7089	Ndonga	7871	Urdu	8582
Fijian	7074	Nederlands	7876	Uzbek	8590
Gaelic; Scottish Gaelic	7168	Nepali	7869	Vietnamese	8673
Gallegan	7176	Norsk	7879	Volapuk	8679
Georgian	7565	Northern Sami	8369	Walloon	8765
Gikuyu; Kikuyu	7573	North Ndebele	7868	Welsh	6789
Guarani	7178	Norwegian Nynorsk;	7878	Wolof	8779
Gujarati	7185	Occitan; Provençal	7967	Xhosa	8872
Hausa	7265	Old Bulgarian; Old Slavonic	6785	Yiddish	8973
Herero	7290	Oriya	7982	Yoruba	8979
Hindi	7273	Oromo	7977	Zulu	9085
Hiri Motu	7279	Ossetian; Ossetic	7983		
Hrvatski	6779	Pali	8073		
Ido	7379	Panjabi	8065		
Interlingua (International)	7365	Persian	7065		
Interlingue	7365	Polski	8076		
Inuktitut	7385	Português	8084		

Contents

Care and Safety Information	
Setup	10
Cleaning discs	10
General Information	
Accessories supplied	11
Region codes.....	11
Connections	
Connecting to television.....	12~13
Using Composite Video jacks (CVBS).....	12
Using Component Video jacks (YPbPr).....	12
Using an accessory RF modulator	13
Connecting the power cord.....	14
Optional connections	
Connecting to a stereo system	15
Stereo system has right/left Audio In jacks.....	15
Connecting to a digital AV receiver	15
Receiver has a PCM, Dolby Digital or MPEG decoder.....	15
Product Overview	
Front and Rear panels	16
Remote Control	17
Getting Started	
Step 1: Inserting Batteries.....	18
Using the remote control to operate the system.....	18
Step 2: Finding your viewing channel.....	18
Step 3: Setting up Progressive Scan feature.....	19
Step 4: TV color system.....	20
Step 5: Setting the language	21
On-screen display (OSD) language.....	21
Audio, Subtitle and Disc menu languages	21
Playback from Disc	
Playable discs.....	22
Supported formats.....	22
Playback Features	
Starting disc playback	23
Basic playback controls.....	23
Pausing playback.....	23
Selecting title/chapter/track	23
Stopping playback.....	23
Operations for video playback.....	24
Using the Disc Menu	24
Zooming in	24
Slow Motion.....	24
Forward / Reverse Searching	24
Selecting various repeat functions	25
Repeat play mode.....	25
Repeating a section within a chapter/track.....	25
Viewing the disc playback information.....	26
Using the OSD menu.....	26

Special DVD Features	27
Playing a Title.....	27
Changing the Audio Language.....	27
Subtitles.....	27
Special VCD and SVCD Feature.....	27
Playback Control (PBC).....	27
Playing MP3/WMA/JPEG/Kodak Picture CD	28
General Operation	28
Playback selection	28
DVD Menu Options	
Using the General setup menu	29
OSD Language.....	29
Sleep.....	29
Using the Audio setup menu.....	30~31
Downmix.....	30
Digital Audio	30-31
Using the Video setup menu	31~33
TV Type.....	32
Setting the TV Display	32
Progressive.....	32
Closed captions	32
Sharpness.....	33
Brightness/Contrast/Color.....	33
Using the Preference setup menu	33~35
Subtitle / Audio / Disc Menu	34
Parental	34
Changing the Password.....	35
Restoring to the original settings.....	35
Others	
Software upgrade	36
Specifications.....	37
Troubleshooting.....	38~39
Glossary.....	40
Limited Warranty.....	41

Care and Safety Information

DANGER!

High voltage! Do not open the device. You run the risk of getting an electric shock.

The machine does not contain any user-serviceable parts. Please leave all maintenance work to qualified personnel.

Setup

Finding a suitable location

- Place the set on a flat, hard and stable surface. Do not place the set on a carpet.
- Do not put any equipment or heavy objects on top of the set.
- Do not position the set on top of other equipment that might heat it up (such as receiver or amplifier).
- Do not put anything under the set (such as CDs, magazines).
- Install this unit near the AC outlet and where the AC power plug can be reached easily.

Space for ventilation

- Place the apparatus in a location with adequate ventilation to prevent internal heat build up. Allow at least 10 cm (4.0") clearance from the rear and the top of the set and 5cm (2.0") from the left and right to prevent overheating.

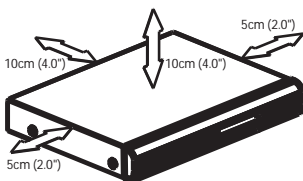

Avoid high temperatures, moisture, water and dust

- Apparatus shall not be exposed to dripping or splashing.
- Do not place any sources of danger on the apparatus (such as liquid filled objects, lighted candles).

Cleaning discs

Some problems occur because the disc inside the player is dirty (frozen picture, sound disruptions, picture distortions). To avoid these problems, discs should be cleaned on a regular basis.

To clean a disc, use a micro fibre cleaning cloth and wipe the disc from the center to the edge in a straight line.

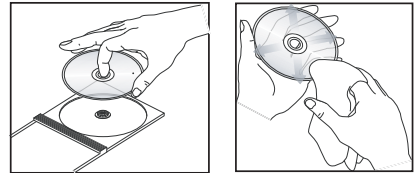

CAUTION!

Do not use solvents such as benzene, thinner, commercially available cleaners, or anti-static sprays intended for analog discs. Since the optical unit (laser) of the DVD player operates at a higher power than regular DVD or CD players, cleaning CDs intended for DVD or CD players may damage the optical unit (laser). Therefore, refrain from using a cleaning CD.

Accessories supplied

Composite video cable (yellow) and audio cables (white, red)

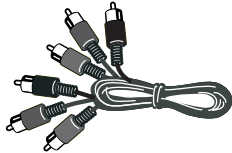

Remote control and two AAA batteries



Region codes

This DVD player is designed to support the Region Management System. Check the regional code number on the disc package. If the number does not match the player's region number (see table below), the player may be unable to playback the disc.

Tips:

- It may not be possible to play CD-R/RW or DVD-R/RW in all cases due to the type of disc or condition of the recording.
- If you are having trouble playing a certain disc, remove the disc and try a different one. Improper formatted disc will not played on this DVD player.

Region	Discs that can be played	
U.S.A. and Canada regions		
U.K and Europe regions		
Asia Pacific, Taiwan, Korea		
Australia, New Zealand, Latin America		
Russia and India regions		
China, Calcos Islands, Walls and Futuna Islands		

Connecting to television

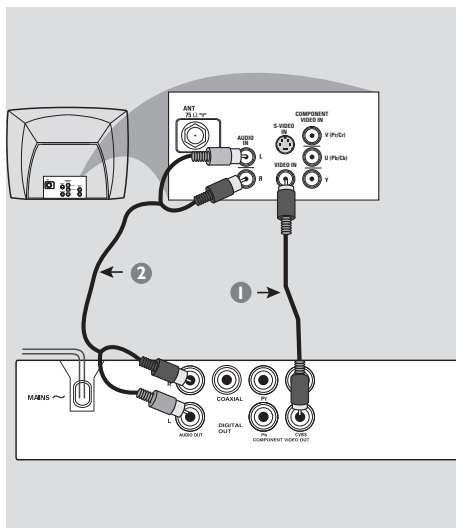

IMPORTANT!

- You only need to make one video connection from the following options, depending on the capabilities of your television.
- Connect the DVD player directly to the television.

Using Composite Video jacks (CVBS)

- 1 Use the composite video cable (yellow) to connect the DVD player's **CVBS** jack to the video input jack (or labeled as A/V In, Video In, Composite or Baseband) on the television (cable supplied).
- 2 To hear sound of this DVD player through your television, use the audio cables (white/red) to connect AUDIO OUT (L/R) jacks of the DVD player to the corresponding AUDIO IN jacks on the television (cable supplied).

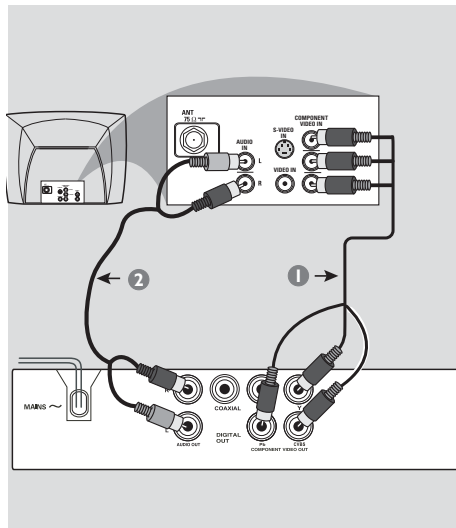

IMPORTANT!

- The progressive scan video quality is only possible when using **YPbPr** and a progressive scan television is required.

Using Component Video jacks (YPbPr)

- 1 Use the component video cables (red/blue/green) to connect the DVD player's **YPbPr** jacks to the component video input jacks (or labeled as YPbPr) on the television (cable not supplied).
- 2 To hear sound of this DVD player through your television, use the audio cables (white/red) to connect AUDIO OUT (L/R) jacks of the DVD player to the corresponding AUDIO IN jacks on the television (cable supplied).
- 3 Proceed to page 19 for detailed progressive scan setup.

TIPS: Before making or changing any connections, make sure that all the devices are disconnected from the power outlet.

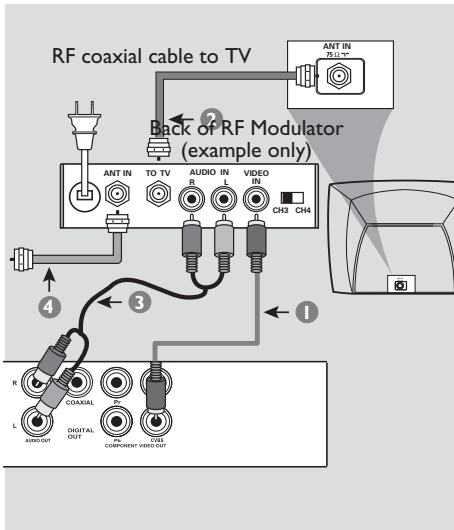

IMPORTANT!

– If your television only has a single Antenna In jack (or labeled as 75 ohm or RF In,) you will need an RF modulator in order to view the DVD playback on the television. See your electronics retailer or contact Philips for details on RF modulator availability and operations.

Using an accessory RF modulator

- 1 Use the composite video cable (yellow) to connect the DVD player's **CVBS** jack to the video input jack on the RF modulator.
- 2 Use the RF coaxial cable (not supplied) to connect ANTENNA OUT or TO TV jack on the RF modulator to the ANTENNA IN jack on the television.

- 3 To hear sound of this DVD player through your TV, use the audio cables (white/red) to connect AUDIO OUT (L/R) jacks of the DVD player to the corresponding AUDIO IN jacks on the RF modulator (cable supplied).
- 4 Connect the Antenna or Cable TV service signal to the ANTENNA IN or RF IN jack on the RF modulator. (It may have been connected to your TV previously. Disconnect it from the TV).

TIPS: Before making or changing any connections, make sure that all the devices are disconnected from the power outlet.

Connecting the power cord

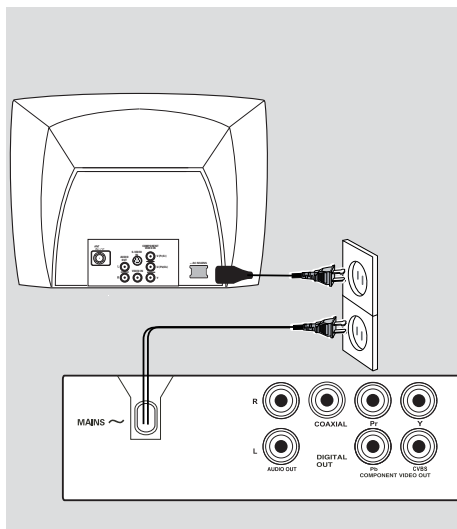

After everything is connected properly, plug in the AC power cord to the power outlet.

Never make or change any connections with the power switched on.

TIPS: Before making or changing any connections, make sure that all the devices are disconnected from the power outlet.

Connecting to a stereo system

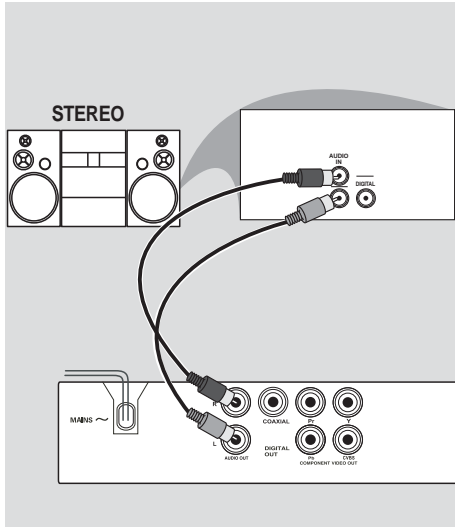

Stereo system has right/ left Audio In jacks

- 1 Select one of the video connections (CVBS VIDEO IN or COMPONENT VIDEO IN) depending on the options available on your television.
- 2 Use the audio cables (white/red) to connect AUDIO OUT (L/R) jacks of the DVD Player to the corresponding AUDIO IN jacks on the stereo system (cable supplied).

Connecting to a digital AV receiver

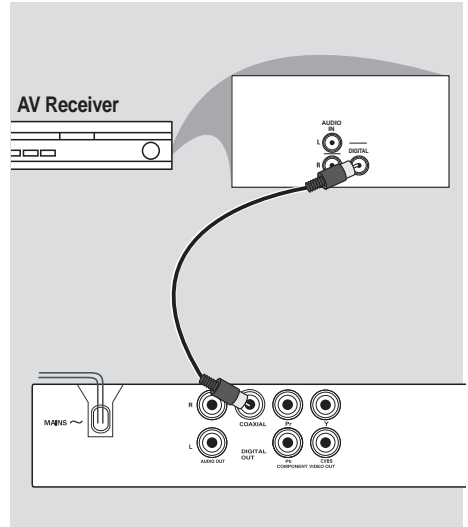

Receiver has a PCM, Dolby Digital or MPEG decoder

- 1 Select one of the video connections (CVBS VIDEO IN or COMPONENT VIDEO IN) depending on the options available on your television.
- 2 Connect the COAXIAL jack of the DVD player to the corresponding Digital Audio In jack on your receiver (cable not supplied).
- 3 Set the DVD player's digital output to PCM-Only or ALL depending on the capabilities of your receiver (see page 31 {Digital Output}).

Tip:

– If the audio format of the Digital Output does not match the capabilities of your receiver, the receiver will produce a strong, distorted sound or no sound at all.

TIPS: Before making or changing any connections, make sure that all the devices are disconnected from the power outlet.

Product Overview

Front and Rear panels

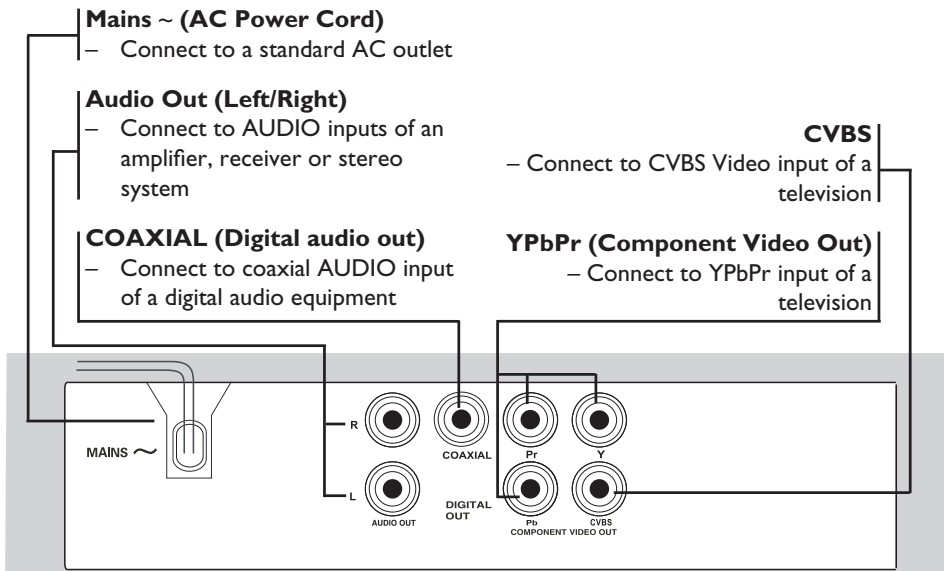
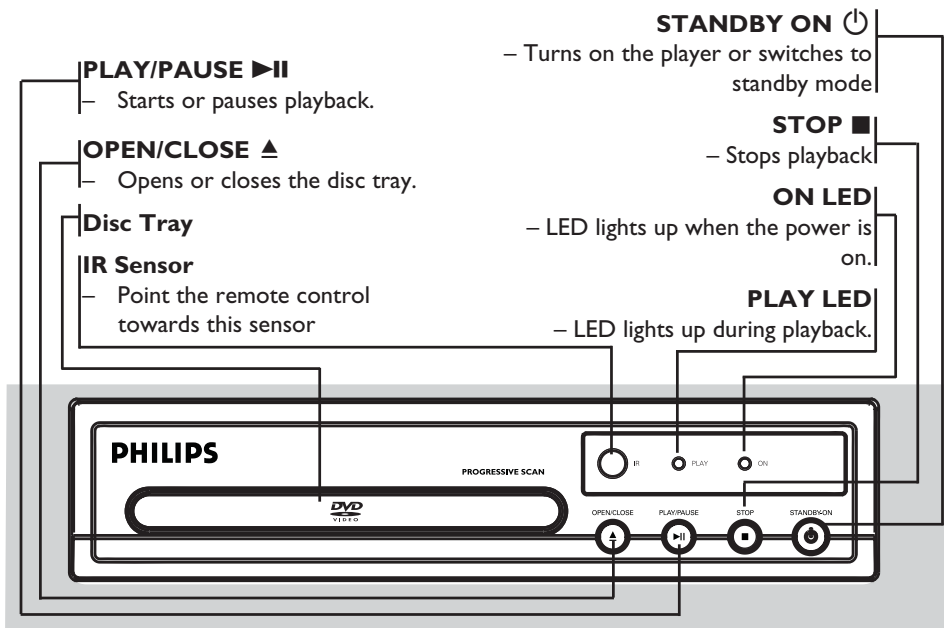

Remote Control

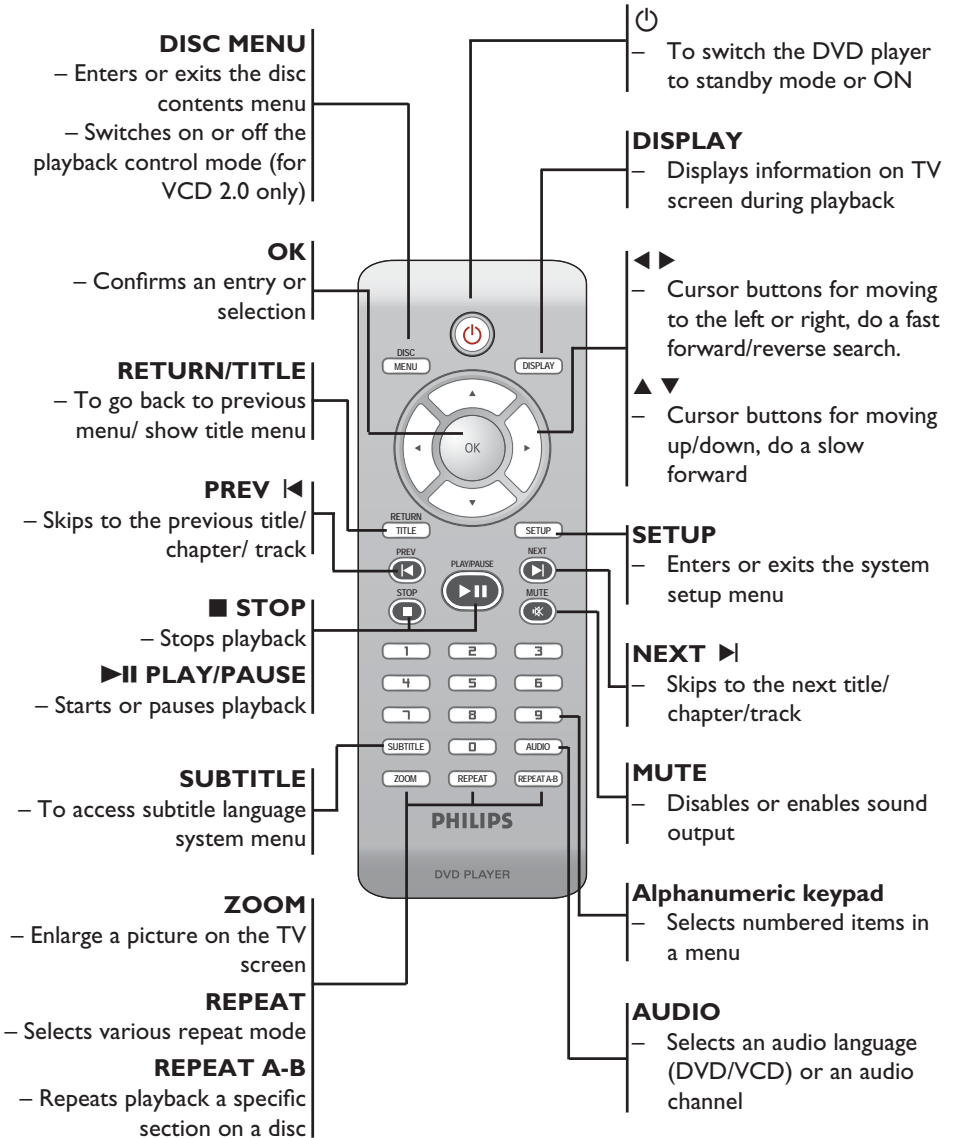

Getting Started

Step 1 : Inserting Batteries

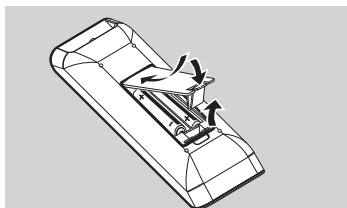

- 1 Open the battery compartment.
- 2 Insert two batteries type R03 or AAA, following the indications (+ -) inside the compartment.
- 3 Close the cover.

CAUTION!

- Remove batteries if they are exhausted or if the remote is not to be used for a long time.
- Do not use old and new or different types of batteries in combination.
- Batteries contain chemical substances, so they should be disposed of properly.

Using the remote control to operate the system

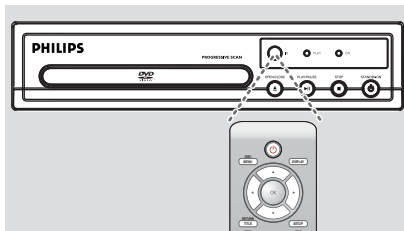

- 1 Aim the remote control directly at the remote sensor (IR) on the front panel.
- 2 Do not put any objects between the remote control and the DVD player while operating the DVD player.

Step 2 : Finding your viewing channel

- 1 Press **STANDBY-ON**  on the DVD player to turn it on.
- 2 Turn on the TV and set it to the correct video-in channel. You should see the blue DVD background screen.
 - Usually these channel are between the lowest and highest channels and may be called FRONT, A/V IN, VIDEO. See your TV's manual for more details.
 - Or, you may go to channel 1 on your TV, then press the Channel down button repeatedly until you see the Video In channel.
 - Or, the TV remote control may have a button or turn that chooses different video modes.
 - Or, set the TV to channel 3 or 4 if you are using an RF modulator.
- 3 If you are using external equipment, (such as audio system or receiver), turn it on and select the appropriate input source for the DVD player output. Refer to the equipment user's manual for detail.

Getting Started (continued)

Step 3 : Setting up Progressive Scan feature

(for Progressive Scan TV only)

The progressive scan displays twice the number of frames per seconds than interlaced scanning (ordinary normal TV system). With nearly double the number of lines, progressive scan offers higher picture resolution and quality.

Before you start...

- Ensure that you have connected this DVD player to a progressive scan TV using the YPbPr connection (see page 12).
- Ensure that you have completed the basic installation and setup.

- 1 Turn on your TV and set to interlace mode (refer to your TV user manual).
- 2 Press **STANDBY-ON**  on the remote control to turn on the DVD player.
- 3 Select the correct video-in channel.
→ The DVD background menu appears.
- 4 Press **SETUP**.
- 5 Press **▶** to select { **Video Setup Page** }.

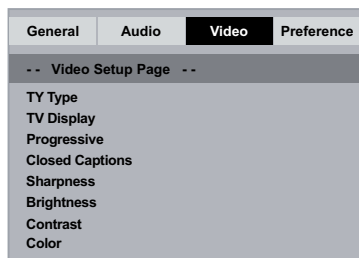

- 6 Press **▲ ▼** repeatedly to select { **Progressive** }, then press **▶**.

- 7 Select { **On** }, then press **OK** to confirm.
→ The menu will appear on the TV.

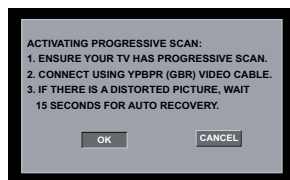

- 8 Press **◀** to highlight { **OK** } and press **OK** to confirm.
- 9 Turn on your TV progressive scan mode (refer to your TV user manual).
→ The menu will appear on the TV.

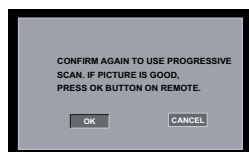

- 10 Press **◀** to highlight { **OK** } and press **OK** to confirm.
→ The setup is now completed and you can start enjoy the high quality picture.

To deactivate Progressive Scan manually:

- Wait for 15 seconds for the auto recovery.
- OR**
- 1 Press **OPEN/CLOSE**  on the DVD player to open the disc tray.
- 2 Press **numeric keypad '1'** on the remote control for few seconds.
→ The DVD background screen appears.

Tip:

– There are some progressive scan TVs and High-Definition TVs that are not fully compatible with this unit, resulting in the unnatural picture when playing back a DVD VIDEO disc in the progressive scan mode. In such a case, turn off the progressive scan feature on both the DVD player and your TV.

TIPS: The underlined option is the factory default setting.
Press **◀** to go back to previous menu item. Press **SETUP** to exit the menu item.

Step 4 : TV color system

The color system of the DVD player, disc and TV should match in order for the disc to play.

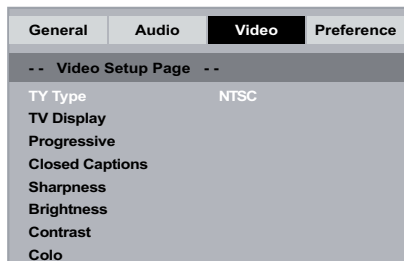

- 1 Press **SETUP**.
- 2 Press **▶** to select { **Video Setup Page** }.
- 3 Press **▲ ▼** repeatedly to select { **TV Type** }.

{ **NTSC** }

Select this if the connected TV has the NTSC color system. It will change the video signal of a PAL disc and output it to NTSC format.

- 4 Press **OK** to confirm.

Tip:

– Before changing the current TV color setting, ensure that your TV supports the 'NTSC'.

TIPS: The underlined option is the factory default setting.
Press **◀** to go back to previous menu item. Press **SETUP** to exit the menu item.

Step 5 : Setting the language

The language options are different depending on your country or region. It may not correspond to the illustrations shown on the user manual.

On-screen display (OSD) language

Select this to change the language of this DVD player screen display menu.

The menu language (on-screen display) for the system will remain as you set it.

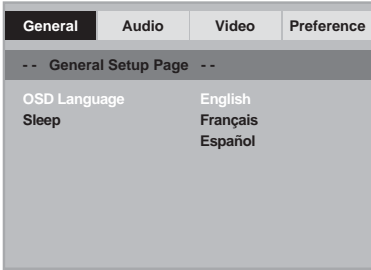

- 1 Press **SETUP**.
- 2 Press **▲ ▼** to select { **OSD Language** }, then press **▶**.
- 3 Use **▲ ▼** to select a language and press **OK** to confirm.

Audio, Subtitle and Disc menu languages

You can choose your preferred language or sound track from audio, subtitles and disc menu languages. If the selected language is not available on the disc, the disc's default language will be used instead.

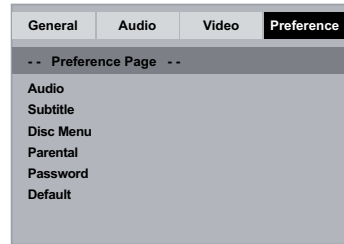

- 1 Press **STOP** **■** twice to stop playback, (if any), then press **SETUP**.
- 2 Press **▶** to select { **Preference Page** }.
- 3 Press **▲ ▼** to highlight one of the options below, then press **▶**.
 - { **Audio** }
Select this to change disc sound track language.
 - { **Subtitle** }
Select this to change the subtitle language.
 - { **Disc Menu** }
Select this to change the language of the disc menu.
- 4 Use **▲ ▼** to select a language and press **OK** to confirm.

If the language you want is not in the list, then select { Others }, then use the **numeric keypad (0-9)** on the remote to enter the 4-digit language code 'XXXX' (see page 7 'Language Code') and press **OK**.

- 5 Repeat steps 3 - 4 for other language settings.

TIPS: The underlined option is the factory default setting.
Press **◀** to go back to previous menu item. Press **SETUP** to exit the menu item.

Playback from Disc

IMPORTANT!

– If the inhibit icon  appears on the TV screen when a button is pressed, it means the function is not available on the current disc or at the current time.

– DVD discs and players are designed with regional restrictions. Before playing a disc, make sure the disc is for the same zone as your player.

Playable discs

Using this DVD player, you can playback on the following discs:

DVD Video (Digital Versatile Disc)



DVD±RW (DVD Rewritable) Audio/Video format or MP3/WMA/JPEG files.



DVD±R (DVD Recordable) Audio/Video format or MP3/WMA/JPEG files.



CD-R (CD-Recordable) Audio/Video format or MP3/WMA/JPEG files.



CD-RW (CD-Rewritable) Audio/Video format or MP3/WMA/JPEG files.



Audio CD (Compact Disc Digital Audio)



Video CD
(Formats 1.0, 1.1, 2.0)



Super Video CD



MP3-Disc



Supported formats

MP3/WMA tracks





- The file extensions has to be '.mp3', '.wma'
- JPEG/ISO format
- Maximum 14 characters display.
- Supported bit-rate;
32 – 320 kbps (MP3)
32 – 192 kbps (WMA)

JPEG pictures

- The file extensions has to be '.JPG' and not '.JPEG.'
- JPEG/ISO format
- It can only display DCF-standard still pictures or JPEG pictures such as TIFF.

TIPS: Some discs cannot be played on this DVD player due to the configuration and characteristics of the disc, or due to the condition of recording and authoring software that was used.

Starting disc playback

- 1 Turn on the TV to the correct program number for the DVD player (e.g. 'EXT', '0', 'AV').
- 2 Press **STANDBY-ON**  to turn on the DVD player.
- 3 Press **OPEN/CLOSE**  on the front of the DVD player.
 - You can also hold down the **STOP**  button on the remote control to open and close the disc tray.
- 4 Place a disc into the disc tray with the label facing up, then press **OPEN/CLOSE** .
 - For double-sided discs, load the side which you want to play facing up.
- 5 Playback may start automatically. If not, press **PLAY/PAUSE** .
- If a disc menu appears on the TV, see page 24 'Using the Disc Menu'.
- If the child lock was activated for the inserted disc, you have to enter your six-digit password (see page 35).
- For more playback features, see pages 23~28.



Tips:

- Do not overturn the DVD player while disc loading, playing or ejecting.
- Do not close the disc tray manually even if the power switched off.



Basic playback controls

Unless otherwise stated, all operations described are based on Remote Control use.

Pausing playback

- 1 During playback, press **PLAY/PAUSE**  to pause playback and display a still picture.
 - Sound will be muted.
- 2 To resume normal playback, press **PLAY/PAUSE**  again.

Selecting title/chapter/track

- During playback, press **PREV**  to go to the beginning of the current chapter/track, press **PREV**  again to go to the previous title/chapter/track.
- Press **NEXT**  to go to the next chapter/track.
- Press **DISPLAY** to display the disc information text line for title/chapter/track (example - 00/08).
- Use **alphanumeric keypad (0-9)** to enter valid title/chapter/track number.
 - The playback skips to the selected title/chapter/track.

Stopping playback

- Press **STOP** .

Tips:

- Screen saver will start automatically if the disc playback is stopped/paused for about 5 minutes.
- The player will automatically switch to Power Standby mode if you do not press any buttons for about 15 minutes after the disc has stopped playing.

TIPS: The operating features described here might not be possible for certain discs. Always refer to the instructions supplied with the discs.

Operations for video playback

Using the Disc Menu

Depending on the disc, a menu may appear on the TV screen once you load in the disc.

To select a playback feature or item

- Use **▲ ▼ ◀ ▶** keys or **numeric keypad (0-9)** on the remote, then press **OK** to start playback.

To access or remove the menu

- Press **DISC MENU** on the remote.

Zooming in

This function allows you to enlarge the picture on the TV screen and to pan through the enlarged picture.

- ① During playback, press **ZOOM** repeatedly to display the picture with different scales.
 - Use **▲ ▼ ◀ ▶** keys to pan through the enlarged picture.
 - Playback will continue.
- ② Press **ZOOM** repeatedly to return to the original size.

Slow Motion

You can slow forward a disc during playback and select a different speed.

For DVD,VCD,SVCD

- ① Press **▲** during playback to select the required speed: 1/2, 1/4, 1/8 or 1/16.
 - Sound will be muted.
- ② To return to normal speed, press **PLAY/PAUSE ▶II**.

Forward / Reverse Searching

You can fast forward or fast reverse a disc during playback and select a desired search speed.

For DVD,VCD,SVCD,CD,MP3,WMA

- ① Press **◀ ▶** directly or press **◀ ▶** for 2 seconds during playback to select the required speed: 2X, 4X, 8X, 16X or 32X (backward or forward).
 - Sound will be muted (DVD/VCD/SVCD) or intermittent (MP3/WMA/CD).
- ② To return to normal speed, press **PLAY/PAUSE ▶II**.

TIPS: The operating features described here might not be possible for certain discs. Always refer to the instructions supplied with the discs.

Selecting various repeat functions

Repeat play mode

The repeat play options vary depending on the disc type.

- 1 While playing a disc, press **REPEAT** continuously to choose a repeat options.

For DVD

- Chapter (currently playing chapter)
- Title (currently playing title)
- All (entire disc)
- Off (cancel)

For Video CD

- Track (currently playing track)
- All (entire disc)
- Off (cancel)

For MP3/WMA/Audio CD

- Repeat One (currently playing file)
- Repeat Folder (current folder)
- Folder (playing all files in one folder once)
- Single (currently playing file once).

For JPEG

In STOP mode,

- Repeat One (currently playing file)
- Repeat Folder (current folder)
- Folder (playing all files in one folder once)
- Single (currently playing file once).

In PLAY mode,

- Repeat One (currently playing file)
- Repeat All (all files in the selected folder)
- Repeat Off (playing all files in one folder once)
- Single (currently playing file once).

- 2 To cancel repeat playback, press **STOP** ■.

Tip:

- For VCD, repeat playback is not possible if the PBC mode is switched on.

Repeating a section within a chapter/track

You can repeat the playback of a specific segment within a title/chapter track. To do this, you must mark the start and end of the segment you want.

- 1 While playing a disc, press **REPEAT A-B** at your chosen starting point.
- 2 Press **REPEAT A-B** again at your chosen end point.
 - The section A and B can be set only within the same chapter/track.
 - The section will now repeat continuously.
- 3 To exit the sequence, press **REPEAT A-B**.

TIPS: The operating features described here might not be possible for certain discs. Always refer to the instructions supplied with the discs.

Viewing the disc playback information

Using the OSD menu

This function displays disc information on the TV screen during playback.

- 1 During playback, press **DISPLAY** repeatedly on the remote control.
 - The available disc information appears on the TV screen.
- 2 Press ◀ ▶ to select an option.
- 3 Enter a valid number in the edit box using the alphanumeric keypad 0-9.
 - The playback will change to the selected angle/title/chapter/track or chosen time.

For DVD

- {_/X Angle}: selecting the playing angle for a multi-angle disc.
- {Title XX/XX Chapter--/XX}: enable to select the available title and chapter for viewing.
- {Title XX/XX Time--:--:--}: enable to select the available title and title playing time for viewing.
- {Chapter XX/XX Time--:--:--}: enable to select the available chapter and chapter playing time for viewing.

For VCD

- {Disc Go To: --:--}: enable to select any part within the disc
- {Track Go To: --:--}: enable to select any part within the current track
- {Select Track: --:xx}: enable to select any track within the disc

Tip:

- Wait for 5 seconds for the display information to disappear.

TIPS: The operating features described here might not be possible for certain discs. Always refer to the instructions supplied with the discs.

Special DVD Features

Playing a Title

- 1 Press **DISC MENU**.
→ The disc title menu appears on the TV screen.
- 2 Use **▲ ▼ ◀ ▶** keys or **alphanumeric keypad 0-9** to select a play option.
- 3 Press **OK** key to confirm.

Changing the Audio Language

For DVD

- Press **AUDIO** repeatedly to select different audio languages.

Changing the Audio Channel For VCD

- Press **AUDIO** to select the available audio channels provided by the disc (MONO LEFT, MONO RIGHT, MIX-MONO, STEREO).

Subtitles

- Press **SUBTITLE** repeatedly to select different subtitle languages.

Special VCD and SVCD Feature

Playback Control (PBC)

For VCD with Playback Control (PBC) feature (version 2.0 only)

- Press **DISC MENU** to toggle between 'PBC ON' and 'PBC OFF'.
→ If you select 'PBC ON', the disc menu (if available) will appear on the TV.
→ Use the **PREV ◀ / NEXT ▶** to go to previous/next page or use the **alphanumeric keypad 0-9** to select a play option.
 - During playback, pressing **RETURN/TITLE** will return to the menu screen (if PBC is on).
- If you want to skip the index menu and playable directly from the beginning,**
- Press **DISC MENU** key on the remote control to turn to PBC off.

TIPS: The operating features described here might not be possible for certain discs. Always refer to the instructions supplied with the discs.

Playback Features (continued)

Playing MP3/WMA/JPEG/ Kodak Picture CD

This DVD player can playback MP3, WMA, JPEG and picture CD files on a personally recorded CD-R/RW disc and commercial CD.

IMPORTANT!

You have to turn on your TV and set to the correct Video In channel. (See page 18 'Finding your viewing channel').

General Operation

- 1 Load a disc.
 - The disc reading time may exceed 30 seconds due to the complexity of the directory/file configuration.
 - The data disc menu appears on the TV screen.

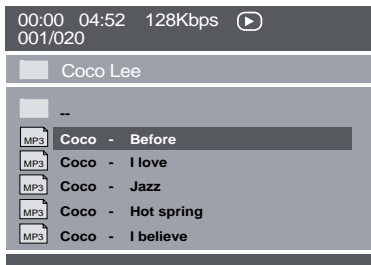

- 2 Press **PREV** ◀ / **NEXT** ▶ to go to previous / next page of the menu.
- 3 Press ▲ ▼ to select the folder and press **OK** to open the folder.
- 4 Press ▲ ▼ to select a track/file.
- 5 Press **OK** to confirm.

Playback selection

During playback, you can;

- Press **PREV** ◀ / **NEXT** ▶ to select the previous/next track/file in the current folder.
- Press **PLAY/PAUSE** ▶|| repeatedly to pause/resume playback.

TIPS: The operating features described here might not be possible for certain discs. Always refer to the instructions supplied with the discs.

This DVD Player setup is carried out via the TV, enabling you to customize the DVD player to suit your particular requirement.

Using the General setup menu

- 1 Press **SETUP** on the remote control.
→ The system setup menu appears.

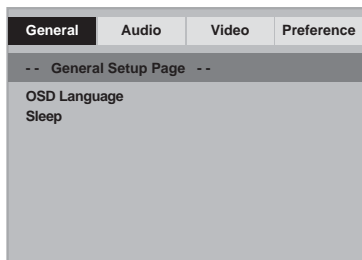

- 2 Press **▲ ▼** to select an item, then press **▶** to access.
Example: { **OSD Language** }
→ The options for the selected item appears.
→ If the selection in the menu is greyed out, that means the feature is not available or not possible to change at the current state.
- 3 Use **▲ ▼** to select a setting and press **OK** to confirm.
Example: { **English** }
→ The setting is selected and setup is complete.
- 4 To exit, press **SETUP**.

OSD Language

This menu contains various language options for the language displayed on the screen. For details, see page 21.

Sleep

Sleep function allows you to turn off the DVD player automatically after a preset time.

- 1 In 'General Setup Page', press **▲ ▼** to select { **Sleep** }, then press **▶**.
{ 15 Mins }
Turn off the DVD player after 15 minutes.
{ 30 Mins }
Turn off the DVD player after 30 minutes.
{ 45 Mins }
Turn off the DVD player after 45 minutes.
{ 60 Mins }
Turn off the DVD player after 60 minutes.
{ Off }
Turn off the sleep function.
- 2 Use **▲ ▼** to select a setting and press **OK** to confirm.

TIPS: The underlined option is the factory default setting.
Press **◀** to go back to previous menu item. Press **SETUP** to exit the menu item.

Using the Audio setup menu

- 1 Press **SETUP** on the remote control.
→ The system setup menu appears.

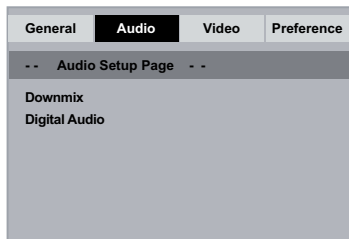

- 2 Press ◀▶ to select { **Audio Setup Page** }.
- 3 Press ▲▼ to select an item, then press ▶ to access.
Example: { **Downmix** }
→ The options for the selected item appears.
→ If the selection in the menu is greyed out, that means the feature is not available or not possible to change at the current state.
- 4 Use ▲▼ to select a setting and press **OK** to confirm.
Example: { **Stereo** }
→ The setting is selected and setup is complete.
- 5 To exit, press **SETUP**.

Downmix

This option allows you to set the stereo analog output of your DVD player.

- 1 In 'Audio Setup Page', press ▲▼ to select { **Downmix** }, then press ▶.

{ **Stereo** }

Select this option when output delivers sound from only the two front speakers.

{ **LT/RT** }

Select this option if your DVD player is connected to a Dolby Pro Logic decoder.

- 2 Use ▲▼ to select a setting and press **OK** to confirm.

Digital Audio

The options included in Digital Audio are: {Digital Output} and {LPCM Output}.

- 1 In 'Audio Setup Page', press ▲▼ to select { **Digital Audio** }, then press ▶.
- 2 Press ▲▼ to select an item, then press ▶ to access.
- 3 Use ▲▼ to select a setting and press **OK** to confirm.

TIPS: The underlined option is the factory default setting.
Press ◀ to go back to previous menu item. Press **SETUP** to exit the menu item.

Digital Output

Set the Digital Output according to your optional audio equipment connection.

{ All }

Select this if the connected device has a built-in multichannel decoder that supports one of the multichannel audio format (Dolby Digital, MPEG-2).

{ PCM Only }

Select this if the connected device is not capable of decoding multichannel audio. The DVD player will convert the Dolby Digital and MPEG-2 multichannel signals to PCM (Pulse Code Modulation).

{ SPDIF Off }

To deactivate the digital audio output. For example, if you use the AUDIO OUT sockets to connect to a TV or stereo system.

LPCM Output

If you connect the DVD player to a PCM compatible receiver via the digital terminals, such as coaxial or optical etc, you may need to adjust 'LPCM Output'.

{ 48K }

Playback a disc recorded at the sampling rate of 48kHz.

{ 96K }

Playback a disc recorded at the sampling rate of 96kHz. This rate can only be achieved in Stereo-Classic (Flat) mode.

Tip:

– Discs are recorded at a certain sampling rate. The higher the sampling rate, the better sound quality. LPCM Output can be selected only when PCM Only is activated.

Using the Video setup menu

- 1 Press **SETUP** on the remote control.
→ The system setup menu appears.

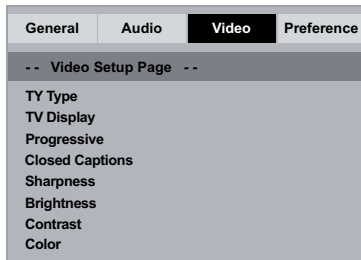

- 2 Press ◀ ▶ to select { **Video Setup Page** }.
- 3 Press ▲ ▼ to select an item, then press ▶ to access.
Example: { **TV Display** }
→ The options for the selected item appears.
→ If the selection in the menu is greyed out, that means the feature is not available or not possible to change at the current state.
- 4 Use ▲ ▼ to select a setting and press **OK** to confirm.
Example: { **4:3 Pan Scan** }
→ The setting is selected and setup is complete.
- 5 To exit, press **SETUP**.

TIPS: The underlined option is the factory default setting.
Press ◀ to go back to previous menu item. Press **SETUP** to exit the menu item.

DVD Menu Options (continued)

TV Type

This menu contains the options for selecting the color system that matches the connected TV. For details, see page 20.

Setting the TV Display

The picture shape can be adjusted to fit your TV and the format must be available on the playback disc. Otherwise, the TV display will not affect the picture during playback.

- 1 In 'Video Setup Page', press ▲ ▼ to select { **TV Display** }, then press ►.

{ 4:3 Pan Scan }

Select this if you have a normal TV and want both sides of the picture to be trimmed or formatted on the TV screen.



{ **4:3 Letter Box** }

Select this if you have a normal TV. A 'wide-screen' display with black bars on the top and bottom will be displayed on the TV screen.



{ 16:9 }

Select this for wide-screen TV (frame ratio 16:9).



- 2 Use ▲ ▼ to select a setting and press **OK** to confirm.

Progressive

In the progressive scan mode, you can enjoy the high quality picture with less flickers. It only works when you have connected the DVD player's YPbPr jacks to your TV that supports the progressive video input. Otherwise, a distorted picture will appear on the TV. For proper progressive scan set up, see page 19.

- 1 In 'Video Setup Page', press ▲ ▼ to select { **Progressive** }, then press ►.

{ Off }

To disable Progressive Scan function.

{ **On** }

To enable Progressive Scan function.

- 2 Use ▲ ▼ to select a setting and press **OK** to confirm.
 - Follow the instructions shown on the TV screen to confirm the selection (if any).
 - If a distorted picture appears on the TV screen, wait for 15 seconds for auto recovery.

Closed Captions

Closed caption are data that are hidden in the video signal of some discs.

Captions are different from subtitles because captions hearing are impaired by showing the sound effects (e.g., "phone ringing" and "footsteps"), while subtitles do not. Before you select this function, ensure that the disc contains closed captions information and your TV set also has this function.

- 1 In 'Video Setup Page', press ▲ ▼ to select { **Closed Captions** }, then press ►.

{ **On** }

Enable closed caption.

{ Off }

Disable closed caption.

- 2 Use ▲ ▼ to select a setting and press **OK** to confirm.

TIPS: The underlined option is the factory default setting.
Press ◀ to go back to previous menu item. Press **SETUP** to exit the menu item.

Sharpness

You can personalize your picture color by adjusting sharpness.

- In 'Video Setup Page', press ▲ ▼ to select { **Sharpness** }, then press ►.
 { **High** }
 Choose high to make the picture's edge sharper.
 { **Medium** }
 Choose medium to get a standard picture.
 { **Low** }
 Choose low to make the picture's edge softer.
- Use ▲ ▼ to select a setting and press **OK** to confirm.

Brightness/Contrast/Color

Increasing the value will brighten the picture or vice versa. Choose zero (0) for average setting.

- In 'Video Setup Page', press ▲ ▼ to select { **Brightness** }, { **Contrast** }, { **Color** }, then press ►.
 → The menu will appear on the TV screen.

Brightness 0

Contrast 0

Color 0

- Press ▲ ▼ ◀ ▶ to adjust the setting that best suits your personal preference.
- Press **OK** to confirm.

Using the Preference setup menu

- Press **STOP** ■ twice to stop playback, (if any), then press **SETUP** on the remote control.
 → The system setup menu appears.

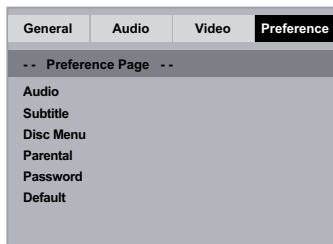

- Press ► to select { **Preference Page** }.
- Press ▲ ▼ to select an item, then press ► to access.
 Example: { **Parental** }
 → The options for the selected item appears.
 → If the selection in the menu is greyed out, that means the feature is not available or not possible to change at the current state.
- Use ▲ ▼ to select a setting and press **OK** to confirm.
 Example: { **8 Adult** }
 → The setting is selected and setup is complete.
- To exit, press **SETUP**.

TIPS: The underlined option is the factory default setting.
 Press ◀ to go back to previous menu item. Press **SETUP** to exit the menu item.

Subtitle/Audio/Disc Menu

These menus contains various language options for audio, subtitle and disc menu which may be recorded on the DVD. For details, see page 21.

Parental

Depending on the DVD, you may be asked to change the parental level while playing the disc. The rating levels are from 1 to 8 and are country dependent. You can prohibit the playing of certain discs that are not suitable for your children, or have certain discs played with alternative scenes.

- 1 In 'Preference Page', press ▲ ▼ to select { **Parental** }, then press ►.

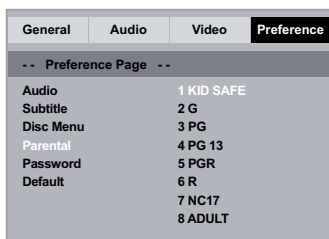

- 2 Use ▲ ▼ to select a rating level and press **OK** to confirm.
→ Select { **8 Adult** } to disable parental level and allow all discs to play.
- 3 Use the **alphanumeric keypad 0-9** to enter the six-digit password (see page 35 'Changing the Password'), then press **OK** to confirm.
- DVDs that are rated higher than the level you selected will not play unless you enter your six-digit password.

Rating Explanations

- { **1. Kid Safe** }
Childsafe; acceptable for viewers of all ages.
- { **2. G** }
General Audience; recommended as acceptable for viewers of all ages.
- { **3. PG** }
Parental Guidance suggested.
- { **4. PG – 13** }
Unsuitable for children under age 13.
- { **5. PG – R** }
Parental Guidance; recommended that parents restrict children under 17 from viewing.
- { **6. R** }
Restricted; recommended only when supervised by a parent or adult guardian.
- { **7. NC – 17** }
No Children under age 17; not recommended viewing for children under age 17.
- { **8. Adult** }
Mature Material; should be viewed only by adults due to graphic sexual material, violence or language.

Tips:

- This feature will not limit viewing if the disc manufacturer did not code the disc.
- VCD, SVCD, CD have no level indication, so parental control has no effect on these type of discs. This also applies to most illegal DVDs.
- Some DVDs are not coded with a rating though the movie rating may be printed on the disc cover. The rating level feature does not prohibit play of such discs.

TIPS: The underlined option is the factory default setting.
Press ◀ to go back to previous menu item. Press **SETUP** to exit the menu item.

Changing the Password

You need to enter your six-digit password to play a prohibited disc or if prompted for a password. The same default password is used for Parental.

- 1 In 'Preference Page', press ▲ ▼ to select { **Password** }, then press ► to select { **Change** }.
- 2 Press **OK** and the menu appears on the TV screen.

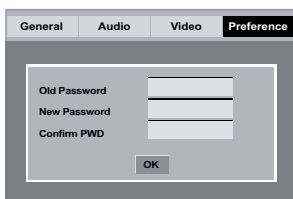

- 3 Use the **alphanumeric keypad 0-9** to enter the six-digit password.
 - When doing this for the first time, enter the default password '136900'.
- If you forget your old six-digit password, enter the default password '136900'.
- 4 Enter the new six-digit password.
- 5 Enter the new six-digit password a second time to confirm.
 - The new six-digit password will now take effect.
- 6 Press **OK** to confirm.

Restoring to the original settings

Setting the { **Default** } function will reset all options and your personal settings to the factory defaults, except your Parental.

- 1 In 'Preference Page', press ▲ ▼ to select { **Default** }, then press ► to select { **Reset** }.
- 2 Press **OK** to confirm.
 - All settings will now reset to factory defaults.

TIPS: The underlined option is the factory default setting.
Press ◀ to go back to previous menu item. Press **SETUP** to exit the menu item.

Software upgrade

Periodically Philips will issue software upgrade to enhance your user experience.

IMPORTANT!

– Power supply must not be interrupted during upgrade!

To check the current software version of this DVD player;

- 1 Press **OPEN/CLOSE ▲** on the DVD player to open the disc tray.
→ The disc tray will open.
- 2 Press **numeric keypad '55'** on the remote control.
→ The file name of the software installed in the DVD player appears on the TV screen.

To download and install the latest software to the DVD player;

- 1 Visit the Philips website 'www.philips.com/welcome' to check the availability of the latest software upgrade.
- 2 Download the software to a CD-R.
- 3 Insert the CD-R to the disc slot.
→ The menu appears on the TV screen.

Upgrade File Detected

Upgrade?

Press Play to start

- 4 Press **PLAY/PAUSE ►||** to download the latest software in the DVD player.
→ The DVD player will re-start automatically once the download complete.

TV STANDARD (NTSC/60Hz)

Number of lines	525
Playback	(NTSC)

VIDEO PERFORMANCE

Video DAC	12 bit, 108 MHz
YPbPr	0.7 Vpp ~ 75 ohm
Video Output	1Vpp ~ 75 ohm

VIDEO FORMAT

Digital	MPEG 2 for DVD,SVCD
Compression	MPEG 1 for VCD

DVD 50Hz 60Hz

Horiz. resolution	720 pixels	720 pixels
Vertical resolution	576 lines	480 lines

VCD 50Hz 60Hz

Horiz. resolution	352 pixels	352 pixels
Vertical resolution	288 lines	240 lines

AUDIO FORMAT

Digital	MPEG/ AC-3/ PCM	compressed Digital 16, 20, 24 bits fs, 44.1, 48, 96 kHz
	MP3(ISO 9660)	96, 112, 128, 256, 320kbps & variable bit rate fs, 32, 44.1, 48 kHz

Analog Sound Stereo

Dolby Surround compatible downmix from Dolby

Digital multi-channel sound

AUDIO PERFORMANCE

DA Converter	24 bit, 192 kHz
DVD	fs 96 kHz 4Hz- 44kHz fs 48 kHz 4Hz- 22kHz
SVCD	fs 48 kHz 4Hz- 22kHz fs 44.1kHz 4Hz- 20kHz
CD/VCD	fs 44.1kHz 4Hz- 20kHz
Signal-Noise (1kHz)	> 90 dB
Dynamic range(1kHz)	> 80 dB
Crosstalk (1kHz)	> 70 dB
Distortion/noise (1kHz)	> 65 dB
MPEG MP3	MPEG Audio L3

CONNECTIONS

YPbPr Output	Cinch 3x
Video Output	Cinch (yellow)
Audio Output(L+R)	Cinch (white/red)
Digital Output	1 coaxial IEC60958 for CDDA / LPCM IEC61937 for MPEG 1/2, Dolby Digital

CABINET

Dimensions (w x h x d)	360 x 37 x 235 mm
Weight	Approximately 2 kg

POWER CONSUMPTION

Power Supply Rating	120V; 60Hz
Power consumption	< 10 W
Power consumption in Standby mode	< 1 W

Troubleshooting

WARNING

Under no circumstances should you try to repair the system yourself, as this will invalidate the warranty. Do not open the system as there is a risk of electric shock.

If a fault occurs, first check the points listed below before taking the system for repair. If you are unable to remedy a problem by following these hints, consult your dealer or Philips for help.

Problem	Solution
No power.	<ul style="list-style-type: none">– Press STANDBY-ON button on the front of the DVD player to turn on the system.– Make sure the AC outlet has power.
Remote control does not work.	<ul style="list-style-type: none">– Aim the remote control directly at the sensor on the front of the DVD player (not towards TV).– Remove any obstacles between DVD player and the remote control.– Batteries are weak, replace the batteries.– Check the polarities of the batteries are as indicated on the remote control (\pm signs).
No picture.	<ul style="list-style-type: none">– Turn on your TV and set to the correct Video In channel for the DVD player. You may go to Channel 1 on your TV, then press the channel down button on your TV's remote control until you see the TV program.– Check the video connection between the DVD player and the TV.
The picture is distorted or black & white during playback.	<ul style="list-style-type: none">– The disc is dirty, clean the disc.– Sometimes a small amount of picture distortion may appear. This is not a malfunction.– To deactivate progressive scan function manually;<ol style="list-style-type: none">1) Turn off your TV progressive scan mode (or set to interlaced mode)2) Press OPEN/CLOSE to open the DVD player disc tray.3) Press the alphanumeric keypad 'I' for few seconds.
No sound.	<ul style="list-style-type: none">– Check the audio connections, the red and white jacks are connected correctly.– Set the Digital output correctly, based on the equipment you connected to the DVD player.
Disc does not play.	<ul style="list-style-type: none">– Insert the disc with the label facing up.– Wrong region code.– Wrong disc type. Read chapter "Playback from Disc - Playable discs" for details.– Make sure the disc is not scratched or warped. Clean the disc or replace a new one.– Check if the disc is defective by trying another disc.

Problem	Solution
The aspect ratio of the screen cannot be changed.	<ul style="list-style-type: none">- The aspect ratio is fixed on the DVD disc.- Depending on the TV, it may not be possible to change the aspect ratio.
Not able to select some items in the setup/system menu.	<ul style="list-style-type: none">- Press STOP button twice before selecting the setup/system menu.- Depending on the disc availability, some menu items cannot be selected.
The DVD player does not start playback.	<ul style="list-style-type: none">- Insert a readable disc with the playback side facing down.- Check the disc type, color system (NTSC) and region code.- Check for any scratches or smudges on the disc.- Press SETUP to turn off the setup menu screen.- You may need to enter the password in order to change the parental rating level or to unlock the disc for playback.- Moisture may have condensed inside the system. Remove the disc and leave the system turned on for about an hour.- Disconnect the power cord from the power outlet for a few minutes. Reconnect the power cord and try to operate again as usual.
Picture freezes momentarily during playback.	<ul style="list-style-type: none">- Check the disc for fingerprint/scratches and clean with a soft cloth wiping from center to edge.
Unable to select Progressive Scan on/off.	<ul style="list-style-type: none">- Check that the output of the video signal is turn to { YPbPr }.

Glossary

Analog: Sound that has not been turned into numbers. Analog sound varies, while digital sound has specific numerical values. These jacks send audio through two channels, the left and right.

Aspect ratio: The ratio of vertical and horizontal sizes of a displayed image. The horizontal vs. vertical ratio of conventional TVs. is 4:3, and that of wide-screens is 16:9.

AUDIO OUT Jacks: Jacks on the back of the DVD System that send audio to another system (TV, Stereo, etc.).

Bit Rate: The amount of data used to hold a given length of music; measured in kilobits per seconds, or kbps. Or, the speed at which you record. Generally, the higher the bit rate, or the higher the recording speed, the better the sound quality. However, higher bit rates use more space on a Disc.

Chapter: Sections of a picture or a music piece on a DVD that are smaller than titles. A title is composed of several chapters. Each chapter is assigned a chapter number enabling you to locate the chapter you want.

Component Video Out Jacks: Jacks on the back of the DVD System that send high-quality video to a TV that has Component Video In jacks (R/G/B, Y/Pb/Pr, etc.).

Disc menu: A screen display prepared for allowing selection of images, sounds, subtitles, multi-angles, etc recorded on a DVD.

Digital: Sound that has been converted into numerical values. Digital sound is available when you use the DIGITAL AUDIO OUT COAXIAL or OPTICAL jacks. These jacks send audio through multiple channels, instead of just two channels as analog does.

Dolby Digital: A surround sound system developed by Dolby Laboratories containing up to six channels of digital audio (front left and right, surround left and right, center and subwoofer).

JPEG: A very common digital still picture format. A still-picture data compression system proposed by the Joint Photographic Expert Group, which features small decrease in image quality in spite of its high compression ratio.

MP3: A file format with a sound data compression system. 'MP3' is the abbreviation of Motion Picture Experts Group 1 (or MPEG-1) Audio Layer 3. By using MP3 format, one CD-R or CD-RW can contain about 10 times as much data volume as a regular CD can.

Parental Control: A function of the DVD to limit playback of the disc by the age of the users according to the limitation level in each country. The limitation varies from disc to disc; when it is activated, playback will be prohibited if the software's level is higher than the user-set level.

PCM (Pulse Code Modulation): A system for converting analog sound signal to digital signal for later processing, with no data compression used in conversion.

Playback control (PBC): Refers to the signal recorded on video CDs or SVCDs for controlling reproduction. By using menu screens recorded on a Video CD or SVCD that supports PBC, you can enjoy interactive-type software as well as software having a search function.

Progressive Scan: It displays all the horizontal lines of a picture at one time, as a signal frame. This system can convert the interlaced video from DVD into progressive format for connection to a progressive display. It dramatically increases the vertical resolution.

Region code: A system for allowing discs to be played back only in the region designated beforehand. This unit will only play discs that have compatible region codes. You can find the region code of your unit by looking on the product label. Some discs are compatible with more than one region (or ALL regions).

Title: The longest section of a picture or music feature on DVD, music, etc., in video software, or the entire album in audio software. Each title is assigned a title number enabling you to locate the title you want.

CVBS jack: Jack on the back of the DVD System that sends video to a TV.

WMA: Windows Media Audio. Refers to an audio compression technology developed by Microsoft Corporation. WMA data can be encoded by using Windows Media Player version 9 or Windows Media Player for Windows XP. Files are recognized by their file extension "WMA."

PHILIPS LIMITED WARRANTY NINETY (90) DAY

WARRANTY COVERAGE:

PHILIPS warranty obligation is limited to the terms set forth below.

WHO IS COVERED:

Philips warrants the product to the original purchaser or the person receiving the product as a gift against defects in materials and workmanship as based on the date of original purchase ("Warranty Period") from an Authorized Dealer. The original sales receipt showing the product name and the purchase date from an authorized retailer is considered such proof.

WHAT IS COVERED:

The Philips warranty covers new products if a defect in material or workmanship occurs and a valid claim is received by Philips within the Warranty Period. At its option, Philips will either (1) repair the product at no charge, using new or refurbished replacement parts, or (2) exchange the product with a product that is new or which has been manufactured from new, or serviceable used parts and is at least functionally equivalent or most comparable to the original product in Philips current inventory, or (3) refund the original purchase price of the product. Philips warrants replacement products or parts provided under this warranty against defects in materials and workmanship from the date of the replacement or repair for ninety (90) days or for the remaining portion of the original product's warranty, whichever provides longer coverage for you. When a product or part is exchanged, any replacement item becomes your property and the replaced item becomes Philips' property. When a refund is given, your product becomes Philips' property.

Note: Any product sold and identified as refurbished or renewed carries a ninety (90) day limited warranty.

Replacement product can only be sent if all warranty requirements are met. Failure to follow all requirements can result in delay.

WHAT IS NOT COVERED - EXCLUSIONS AND LIMITATIONS:

This Limited Warranty applies only to the new products manufactured by or for Philips that can be identified by the trademark, trade name, or logo affixed to it. This Limited Warranty does not apply to any non-Philips hardware product or any software, even if packaged or sold with the product. Non-Philips manufacturers, suppliers, or publishers may provide a separate warranty for their own products packaged with the bundled product.

Philips is not liable for any damage to or loss of any programs, data, or other information stored on any media contained within the product, or any non-Philips product or part not covered by this warranty. Recovery or reinstallation of programs, data or other information is not covered under this Limited Warranty.

This warranty does not apply (a) to damage caused by accident, abuse, misuse, neglect, misapplication, or non-Philips product, (b) to damage caused by service performed by anyone other than Philips or Philips Authorized Service Location, (c) to a product or a part that has been modified without the written permission of

Philips, or (d) if any Philips serial number has been removed or defaced, or (e) product, accessories or consumables sold "AS IS" without warranty of any kind by including refurbished Philips product sold "AS IS" by some retailers.

This Limited Warranty does not cover:

- Shipping charges to return defective product to Philips.
- Labor charges for installation or setup of the product, adjustment of customer controls on the product, and installation or repair of antenna/signal source systems outside of the product.
- Product repair and/or part replacement because of improper installation or maintenance, connections to improper voltage supply, power line surge, lightning damage, retained images or screen markings resulting from viewing fixed stationary content for extended periods, product cosmetic appearance items due to normal wear and tear, unauthorized repair or other cause not within the control of Philips.
- Damage or claims for products not being available for use, or for lost data or lost software.
- Damage from mishandled shipments or transit accidents when returning product to Philips.
- A product that requires modification or adaptation to enable it to operate in any country other than the country for which it was designed, manufactured, approved and/or authorized, or repair of products damaged by these modifications.
- A product used for commercial or institutional purposes (including but not limited to rental purposes).
- Product lost in shipment and no signature verification receipt can be provided.
- Failure to operate per Owner's Manual.

TO OBTAIN ASSISTANCE IN THE U.S.A., PUERTO RICO, OR U.S. VIRGIN ISLANDS...

Contact Philips Customer Care Center at:
1 866 771 4018

TO OBTAIN ASSISTANCE IN CANADA...

1 800 661 6162 (French Speaking)
1 866 771 4018 - (English or Spanish Speaking)

REPAIR OR REPLACEMENT AS PROVIDED UNDER THIS WARRANTY IS THE EXCLUSIVE REMEDY FOR THE CONSUMER. PHILIPS SHALL NOT BE LIABLE FOR ANY INCIDENTAL OR CONSEQUENTIAL DAMAGES FOR BREACH OF ANY EXPRESS OR IMPLIED WARRANTY ON THIS PRODUCT. EXCEPT TO THE EXTENT PROHIBITED BY APPLICABLE LAW, ANY IMPLIED WARRANTY OF MERCHANTABILITY OR FITNESS FOR A PARTICULAR PURPOSE ON THIS PRODUCT IS LIMITED IN DURATION TO THE DURATION OF THIS WARRANTY.

Some states do not allow the exclusions or limitation of incidental or consequential damages, or allow limitations on how long an implied warranty lasts, so the above limitations or exclusions may not apply to you.

This warranty gives you specific legal rights. You may have other rights which vary from state/province to state/province.

P&F USA, Inc. PO Box 672768 Marietta, GA 30066

3121 233 48792

English

Français

Español



Meet Philips at the Internet
<http://www.philips.com/welcome>

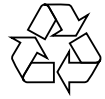

DVPI013

