



使用手册
User manual



目录

1	欢迎	5	5.1 录音说明	11
1.1	产品特点	5		
2	重要须知	6	6. 录音设置	13
2.1	安全	6	6.1 录音场景	13
2.2	听力保护	6	6.2 录音指示灯设置	13
			6.3 声控设置	13
			6.4 监听设置	14
			6.5 分段录音	14
3	您的数码录音笔	7	7 手机 APP 操作说明	15
3.1	供货范围	7	7.1 安装 APP	15
3.2	概览	7	7.2 打开分享	15
			7.3 连接	16
			7.4 控制机器	16
			7.5 设置	18
4	开始使用	9	8 语音模式	19
4.1	开 / 关机	9	8.1 播放菜单	20
4.2	充电方法	9	8.2 删除文件	21
4.3	按键锁定 (HOLD 功能)	10		
4.4	连接电脑	10		
5	录音	11	9 音乐模式	22

9.1 播放菜单	22	11.3 录音笔无法播放录音	30
9.2 删除文件	24		
<hr/>			
10 系统设置	25	12 技术参数	31
10.1 背光时间	25	12.1 存储器	31
10.2 自动关机	25	12.2 尺寸和重量	31
10.3 语言选择	25	12.3 系统要求	31
10.4 按键音	26	12.4 录音	31
10.5 设备 ID	26	12.5 运行条件	31
10.6 内存选择	26		
10.7 磁盘信息	26		
10.8 卡信息	26		
10.9 格式化设备	27		
10.10 固件版本	27		
10.11 系统时间设置	27		
10.12 定时录音设置	28		
10.13 指纹设置	28		
10.14 恢复出厂设置	29		
<hr/>			
11 常见问题	30		
11.1 无法启动录音笔	30		
11.2 录音笔无法录音	30		

1 欢迎

欢迎来到飞利浦世界！您能选择和购买飞利浦的产品，我们非常高兴。您可在我们的官方网站上获得飞利浦公司的全方位技术支持，如：使用手册、软件下载、保修信息等。

www.philips.com

1.1 产品特点

- 一键录音：仅仅拨上录音开关即可实现录音，拨下保存录音。
- 数字降噪：能有效地对录音环境周围的噪声给予滤除，从而可以清晰地记录有效的声音。（此功能建议在嘈杂的环境中使用）
- 支持指纹功能。
- APP 智能操控：实现远距离控制录音；支持边录边翻译。
- OTG 转文本：录音文件文本转换，方便工作、学习。
- 以常见的 MP3 和 WAV 格式录音。
- 使用高速 USB 2.0 快速存取录音和数据。
- 可作为大容量的 USB 存储设备，确保最大的兼容性。

2 重要须知

2.1 安全

为了避免短路，切勿将产品放置在触水受潮处。
不要将产品放在加热设备附近或阳光直射的地方。
请注意，切勿挤压电缆，特别是插头处。



小心

- 特别声明：使用本产品前请仔细阅读本说明书，如因人为操作或不可抗力因素而导致数据丢失，本公司一概不予负责。特别提醒用户小心操作，注意将资料另外备份。
- 图像仅作参考。飞利浦保留更改颜色 / 外观 / 设计 / 参数 / 产品功能的权利，硬件、软件、APP 如有更新，恕不另行通知。

2.2 听力保护

使用耳机时请遵守下列原则：
调整至合适的音量，切勿长时间使用耳机。
特别需要注意，切勿将音量调至耳朵所能承受的范围之外。
切勿将音量调至盖过周边环境的声音。

在危险情况下请小心或暂停使用耳机。

在驾驶汽车、骑自行车、玩滑板时，切勿使用耳机。否则会导致交通意外，且违反相关法律法规。

3 您的数码录音笔

3.1 供货范围：

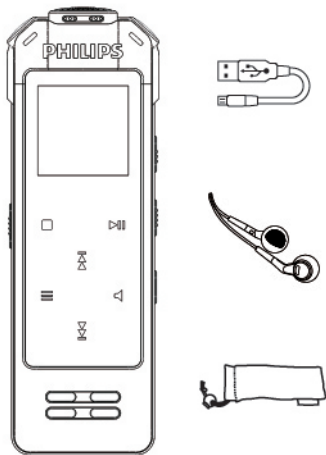

3.2 概览：

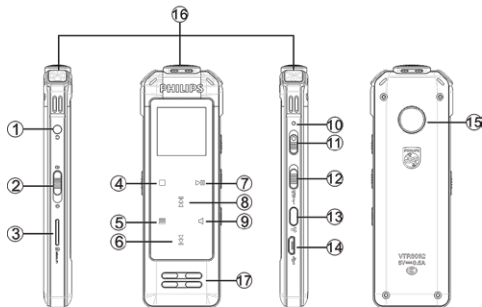

- ① 耳机接口
- ② 开机、关机、锁定键
- ③ TF卡插口
- ④ 返回/切换文件夹触摸键
- ⑤ 菜单键
- ⑥ 下一首/快进键
- ⑦ 播放/暂停/确定键
- ⑧ 上一首/快退键
- ⑨ 音量/删除触摸键
- ⑩ 指示灯
- ⑪ 录音/保存键
- ⑫ 一键降噪
- ⑬ 分享/复位键
- ⑭ USB接口
- ⑮ 指纹模块
- ⑯ 咪头
- ⑰ 喇叭

4 开始使用

4.1 开 / 关机

注意

- 第一次使用机器时，请对该机器充电三小时以确保机器有电工作！

向下滑动开机键 2 到 3 秒钟后，本机立即自动开机或关机，然后显示“PHILIPS 开关机图标”，如下图所示。



然后机器进入录音文件停止播放界面，如下图所示：



在语音播放停止界面长按“菜单”键约 2 到 3 秒，机器返回主界面。在主界面中包含有三个模块：语音模式、音乐模式和系统设置。



注意

- 除了录音和播放过程中，在其它界面下，长按“菜单”键约 2 到 3 秒可返回到主界面。

提示

- 如果录音笔无法正常工作，请确认机器是否已没电。
- 当电量指示标志为“”时，请及时充电。

4.2 充电方法

- 使用 USB 数据线将本机与 PC 相连接，如下左图所示。
 - 使用专用充电器充电，如下右图所示。
- 当采用以上方法连接后，本机进入充电状态。电量指示标志由空到满循环变化，表示本机现正处于充电状态。一般情况下，

充满电需要 3 小时左右。

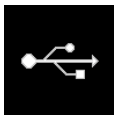

注意

- 当录音笔与电脑连接时，对录音笔的手动操作将无效。

4.3 按键锁定 (HOLD 功能)

- 将开机键向上推至锁定位置，锁定录音笔上除了拨动录音键的所有按键。然后屏幕上短暂显示“锁定图标”后，随即消失，如下图所示。

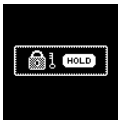

- 要解除按键锁定，请将开机键向下推至中间位置。

4.4 连接电脑

录音笔可作为大容量的 USB 存储设备，并可方便地对文件进行存储、备份和移动。可使用 USB 数据线将录音笔与电脑相连，且无须安装软件，录音笔会自动显示为可移动设备，连接电脑图标如下图所示。

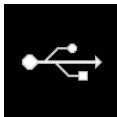

提示

- 在文件移入或移出录音笔时，请不要断开录音笔与电脑的连接。否则会导致文件损坏或磁盘错误，当录音笔与电脑连接时，对录音笔的手动操作将无效。

5 录音

5.1 录音说明

当您初次使用录音笔录音时，请注意本节中的内容说明！

- (1) 在语音模式停止状态下，按“停止”键，切换文件夹。
- (2) 把录音键拨到录音状态开始录音；录音指示灯红灯长亮；
录音时请将麦克风对准音源。
- (3) 按“播放”键暂停录音，录音 / 指示灯红灯闪烁，显示屏显示“暂停”。
- (4) 再次按下“播放”键，继续录音。
- (5) 录音过程中，短按“菜单”键设置书签（INDEX），一个录音文件可以设置 10 个书签，且最多只能设置 10 个录音文件。
- (6) 把录音键拨到停止状态结束录音，并回到当前录音文件的停止播放界面。

录音参考界面如下所示：



录音界面说明：

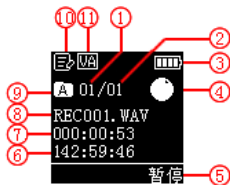

- ① 当前录音文件序号
- ② 当前录音文件数目
- ③ 电量显示
- ④ 当前录音状态
- ⑤ 暂停
- ⑥ 剩余可录时间
- ⑦ 录音持续时间
- ⑧ 当前文件名
- ⑨ 当前文件夹
- ⑩ 当前录音场景
- ⑪ 声控图标



注意

- 电池符号显示空格时，表明低电。低电时系统会自动关机。如果正在录音，系统自动保存录音文件后再关机。电量不足时，请及时充电。低电时提示的参考图标如下所示。



提示

- 录音前，请先设置所需的录音场景。注意：在停止状态下，按“停止键”，可以在 A, B, C, D 和 MUSIC 五个文件夹之间进行转换。录音文件可以在 A, B, C, D 这四个文件夹中进行存储，每个文件夹能存储 99 个录音文件，当一个录音文件夹存满 99 个后，系统会把随后录入的文件自动存储在下一个文件夹中，如果四个文件夹全部录满，要再进行录音，请先删除一些不必要的文件再录。
- 请先测试录音，以确保录音笔设置正确。
- 每个目录最多可存储 99 个文件，总共可容纳 396 个文件（99 文件 x 4 目录）。
- 当录音时间超过录音笔可用容量或达到最大 396 个文件数量的上限时，录音停止。请删除部分录音或将其移至电脑。
- 录音时请勿断电，否则这会导致录音信息丢失和文件损坏。
- 如果需要长时间录音，请在录音前充满电。

6. 录音设置

在语音播放停止界面下，短按菜单键，将会弹出功能菜单列表，功能包括：录音场景、录音指示灯、声控设置、监听设置、分段录音、退出。相关参考图片如下图所示：



6.1 录音场景

在功能菜单中，选择“录音场景”菜单，再按菜单键进入录音场景菜单。在录音场景菜单中有四种录音场景可供选择：“日记模式，采访模式，会议模式，教学模式”。相关参考图片如下：



日记模式：MP3 格式，比特率为 128kbps。

采访模式：WAV 格式，比特率为 1536kbps。

会议模式：WAV 格式，比特率为 1536kbps。

教学模式：WAV 格式，比特率为 1536kbps。

降噪模式：WAV 格式，比特率为 384kbps。

降噪模式选择，侧面降噪键往上推即开启降噪模式。

6.2 录音指示灯设置

在功能菜单中，选择“录音指示灯”菜单，再按“确定”键确认，弹出“开/关”，如下图，录音指示灯选择关时，录音时录音灯不亮。



6.3 声控设置

在功能菜单中，选择“声控设置”，按“确定”键确认，弹出“启用/禁用”，选择启用后，录音过程中，当机器检测到有声音时，录音笔会自动开始录音；当未检测到声音时，录音笔将自动暂停录音；再次检测到声音时，录音笔又会自动开始录音。声控

设置参考界面图片如下：



存并进入下一个文件继续录音。分段录音选择参考界面如下图所示：



6.4 监听设置

监听功能打开后，插入耳机，录音时可以监听，监听设置参考界面图片如下：



6.5 分段录音

在功能菜单中，可设置分段录音，分段时间包括：关闭，30分钟，60分钟，设置好分段时间后，录音会根据设置的时间，自动保

7 手机 APP 操作说明

7.1 安装 APP



(1) 国内下载

Android

- 可通过扫描二维码下载

iOS

- 可通过扫描二维码下载
- 在 App Store 搜索“VTR8062”下载

(2) 国外下载

Android

- 可通过扫描二维码下载

iOS

- 可通过扫描二维码下载
- 在 App Store 搜索“VTR8062”下载



注意

- 安装过程中提示应用需要使用手机中权限时，需要点击“始终允许”。

7.2 打开分享

机器开机后，分享功能会自动打开如图 1，若 5 分钟之后没有被连接，分享功能会自动关闭。如需连接 APP，长按“分享”键 2 秒松开后打开分享功能，当手机连接之后，界面“分享”图标变为蓝色，如图 2，长按“分享图标”键可关闭分享功能。



图 1



图 2



注意

- 进入充电模式或者 USB 模式会关闭分享功能。

7.3 连接

(1) 安卓手机连接:

第一步: 先打开机器端的“分享”功能;

第二步: 打开手机的蓝牙, 去手机桌面点击下载安装好的 APP “”图标;

第三步: 打开手机 APP 后, 进入搜索状态, 如图 1, 搜索完后弹出设备号, 手动点连接;

第四步: 连接成功后会进入 APP 界面, 如图 2, 连接不成功时会退到如图 3 界面, 届时需要再次点重新搜索设备。



图 1



图 2



图 3

(2) 苹果手机连接:

第一步: 下载安装好 A P P 后, 直接在手机桌面打开 A P P,

根据提示连接:

第二步: 直接打开 A P P, 界面会提示“手机蓝牙没打开”, 这个时候需要去设置里或上拉快捷方式处把手机蓝牙打开; 如果已打开蓝牙, 再去打开 A P P 会直接提示“未找到设备, 请点击搜索”;

第三步: 点击搜索后, 会弹出指示图, 根据说明, 点下一步会自动进去搜索状态, 搜索出“PHILIPS verify..”手动点击验证;

第四步: 手动验证成功后, 再根据提示去设置里找到该设备名称, 手动选择连接, 连接成功后, 再去打开 A P P, A P P 左上角显示“已连接”即可使用。

注意

- 1 搜索出来后, 点连接, 多次都连接不上时, 请关闭 APP 及手机蓝牙和机器端的分享功能重新打开;
- 2 在搜索界面直接点右上角的“跳过”会直接进去 APP 界面, 因还没有与机器端连接, 此时操作任何功能都是不响应的。

7.4 控制机器

APP 应用可以控制机器录音、实时翻译、文件、设置等操作, 方便远程操控机器。

7.4.1 录音

连接 APP 后进入 APP 主界面，点“开始录音”APP 会进去如下图，录音状态，机器端也进去录音，点“完成录音”录音保存。

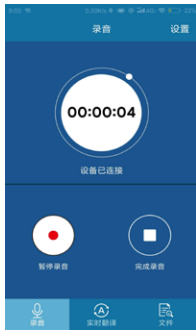

7.4.2 实时翻译

选择 APP 上的“实时翻译”会进入如下界面，点开右上角的按钮，即可进去实时翻译，在此界面可选择“智能翻译助手”、“编辑”、“保存”、“分享”等功能。



7.4.3 文件

打开 APP 上的文件菜单，包括“录音笔文件”、“本地文件”、“已转写文本”，如下图：



录音笔文件：手机可以通过 OTG 线将机器中的音频文件上传到 Android 手机的内存中，进去转写。

本地文件：APP 录制的文件。

已转写文本：已转写过的文本存放处。

注意

- 苹果手机不支持 OTG 功能。
- APP 操作录音，录音文件自动 1 小时保存。

7.5 设置

在 APP 主界面，点开右上角的“设置菜单”，会弹出如下图，“录音场景”、“检查更新”、“断开设备”、“APP 界面介绍”等设置。

注意

- APP 与机器连接使用时，需要断开设备，请先保存录音，再去设置菜单断开设备，不能直接关掉 APP，避免设备与 APP 的连接出现异常；
- 设备与手机 A P P 连接状态下，接通电话后需要手动去切换到手机听筒接电话；
- 设备与手机 A P P 连接超出有效距离后，再回到有效距离需要手动去连接；
- 实时翻译时，请将音源对准麦克风，不要手捂住咪头处，有阻挡物时会影响识别效果；
- 实时翻译时，不要超出识别的有效距离。

8 语音模式

在主界面下，你可以使用“**左**”和“**右**”选择语音模式，然后短按“确定”键确认进入。语音停止界面参考图片如下图所示：



语音文件播放界面说明：

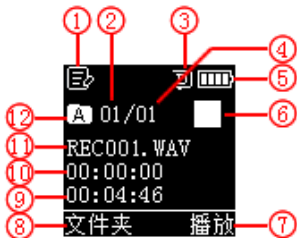

- | | |
|-----------|------------|
| ① 录音场景 | ② 当前录音文件序号 |
| ③ 循环模式 | ④ 录音文件总数目 |
| ⑤ 电量显示 | ⑥ 当前播放状态 |
| ⑦ 文件播放 | ⑧ 文件夹 |
| ⑨ 当前文件总时间 | ⑩ 当前播放时间 |
| ⑪ 当前文件名 | ⑫ 当前文件夹 |

- (1) 在录音文件停止播放模式下，按“停止”键，选择所需文件夹。
- (2) 按“**左**”或“**右**”键，选择要播放的文件。
- (3) 按“播放”键开始播放，播放指示灯绿灯常亮。
- (4) 按“音量键”弹出音量调节界面，使用“**左**”键或“**右**”键调节音量。
- (5) 按“停止”键结束播放。在停止播放状态下，长按“菜单”键约 2 秒返回到主界面。
- (6) 播放过程中，按播放键暂停播放，播放指示灯绿灯闪烁，再次按下播放键，将继续播放。
- (7) 播放时长按“**左**”或“**右**”键，可快退或快进当前正在播放的文件。



提示

- 当耳机插入耳机孔内，录音笔扬声器将停止工作

8.1 播放菜单

选择要播放的录音文件后，短按播放键播放，在播放过程中，短按“菜单键”，弹出如下播放菜单列表：循环模式、复读模式、复读次数、复读间隔、退出。参考界面如下：



(1) 循环模式

在播放过程中，按“菜单”键弹出循环模式，可以选择需要的循环模式，参考界面如下图所示：



目录播放：顺序播放当前文件夹的文件。

目录循环：循环播放选中目录的文件。

单曲循环：一直循环播放选中的文件。

随机播放：随机播放当前文件夹目录文件。

(2) 复读模式

在播放过程中，按“菜单”键弹出“复读模式”，按“确定”键确认，A-B复读的具体操作请参考“音乐播放”部分的A-B复读操作部份。

(3) 复读次数

详细请参考音乐模块复读次数部分。

(4) 复读间隔

详细请参考音乐模块复读间隔部分。

(5) 播放书签

在播放语音文件过程中，长按“菜单”键进入书签菜单，如下左图所示，再选择“转到书签”或“删除书签”，短按“确定”键将进入具体书签界面，如下右图所示：

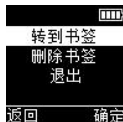

8.2 删除文件

在语音播放停止界面下，长按“音量”键，将会弹出功能菜单：
删除文件、删除全部。

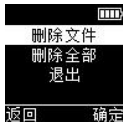

在删除界面，使用“**▲**”键或“**▼**”键选择删除单个文件或所有文件；选择“是”确认删除，选择“否”保持文件；按“确定”键执行命令。

9 音乐模式

在主界面中，可以通过“”和“”键选择音乐模块，然后，短按菜单进入此模块；或者在语音模式下，通过文件夹切换键切换到音乐文件夹。音乐播放参考界面如下图所示：



注意

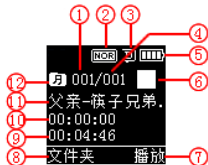

- 音乐文件只能放在“MUSIC”文件夹里面进行播放。

音乐播放界面说明：



- ① 当前文件序号
- ② 音效
- ③ 循环模式
- ④ 文件总数目
- ⑤ 当前电量
- ⑥ 当前播放状态
- ⑦ 文件播放
- ⑧ 切换文件夹
- ⑨ 当前文件总时间
- ⑩ 当前播放时间
- ⑪ 当前文件名
- ⑫ 当前文件夹

9.1 播放菜单

在音乐文件夹播放界面“”和“”选择上下曲，按播放键播放。播放过程中短按菜单键，弹出如下播放菜单列表：循环模式，音效模式，复读模式，复读次数，复读间隔。参考界面如下图所示：

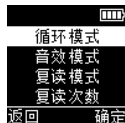

(1) 循环模式

在播放过程中，按“菜单”键弹出循环模式，可以选择需要的循环模式，参考界面如下图所示：



目录播放：顺序播放选中目录的文件，全部播放完一遍当前目录的文件后自动停止播放。

目录循环：循环播放选中目录的文件。

单曲循环：一直循环播放选中的一曲文件。

随机播放：随机播放当前选中目录的文件。

(2) 音效模式

在播放菜单列表中选择“音效模式”菜单，再按菜单键将进入音效模式，音效模式包括以下音效：“自然、摇滚、流行、古典、柔和、爵士、重低音”，参考界面如下图所示：



在音效模式中，你可以使用“**▲**”或“**▼**”选择相应模式，再按“确定”键确认。

(3) 复读模式

在播放菜单列表中选择“复读模式”菜单，再按“确定”键将进入复读模式，参考界面如下图所示：



设置 AB 复读

- 设置复读起点：在播放状态下，短按“菜单”键进入播放菜单，然后短按“**▲**”键或“**▼**”键选择“复读模式”选项，再按“确定”键返回到播放状态，此时播放界面“A-B”的“A”在闪烁，等待确定复读起点A，短按“**▼**”确定复读起点A。
- 设置复读终点：设置复读起点A后，此时播放界面“A-B”的B在闪烁，再短按“**▼**”键，设置复读终点B，此时播放界面显示“A-B”。当复读图标固定“A-B”，开始AB点间的反复播放，到达设定的次数后，闪烁图标“A-B”中的“A”，等待确定起点A，这时播放返回正常播放，如不再需要设定复读，可通过以下方式退出复读模式。
- 取消复读：短按“播放”键，将之前设置AB复读取消，并暂停播放。短按“停止”键，将之前设置AB复读取消，并停止播放。短按“菜单”键，将之前设置AB复读取消，并返回正常播放状态。



(4) 复读次数

在播放菜单列表中选择“复读次数”菜单，再按“菜单”键将进入复读次数设置菜单，通过“**▲**”，“**▼**”键调整次数。参考

界面如下图所示：



(5) 复读间隔

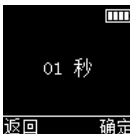

复读间隔意思是两次复读之间的时间间隔。你可以在播放菜单列表中选择“复读间隔”菜单，再按菜单键将进入复读间隔设置。通过“”，“”键调整复读间隔。



9.2 删除文件

在音乐播放停止界面下，长按“音量”键，将会弹出功能菜单列表，功能包括：删除文件、删除全部、退出。下面为执行删除操作的相关参考图片：



在左边界面，使用“”键或“”键选择删除单个文件或所用文件；在右边界面，使用“”和“”选择“是”确认删除，“否”保持文件；按“确定”键执行命令。



注意

- 音乐格式支持列表：

格式	是 / 否（支持）
MP3	支持
AIFF	不支持
ALAC	不支持
APE	部分支持，96KHZ 以上不支持
DSD	不支持
FLAC	部分支持，96KHZ 以上不支持
OGG	不支持
WMA	部分支持，48KHZ 以上不支持
WAV	部分支持，48KHZ 以上不支持

10 系统设置

在主菜单下，选择系统设置模块，再按菜单键将会进入系统设置界面。系统设置界面相关参考图片如下图所示，包括：背光时间、自动关机、语言选择、按键音、设备 ID、内存选择、磁盘信息、卡信息、格式化设备、固件版本、系统时间、定时录音、指纹设置、恢复出厂设置、退出。



10.1 背光时间

背光时间有四种时长可供选择：15 秒，30 秒，60 秒和恒亮。如果在设定的时间内没对机器做任何操作，背光将会自动灭。如果选择恒亮，背光将会恒亮。背光设置参考图片如下：



10.2 自动关机

自动关机有四种时长可供选择：5 分钟，15 分钟，30 分钟和 60 分钟。如果在设定的时间内没对机器做任何操作，系统将会自动关机。自动关机设置参考界面如下：



10.3 语言选择

在语言选择菜单中，你可以选择一种语言作为系统语言。语言选择参考界面如下：



10.4 按键音

在按键音设置菜单中，你可以选择打开或关闭按键音。关闭按键音后，在任何按键操作，按键音都不会起作用。参考图片如下：



10.5 设备 ID

初始默认设备 ID 号为 0000。打开“分享”功能与 APP 连接后，会生成一个 ID 号，在使用 APP 时，要确认是否连接该设备可以查询 ID 号确认。

10.6 内存选择

可以选择内存为机器内置或者 Micro-SD，参考图片如下：



10.7 磁盘信息

查看存储器的空间总量和剩余空间。参考图片如下：



10.8 卡信息

查看插入的 SD 卡的空间总量和剩余空间。参考图片如下：



10.9 格式化设备

格式化本机器内存。参考图片如下：

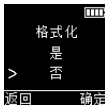

例如：选择“时间格式”菜单，将会显示如下参考界面：

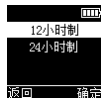

此界面下有两种时间显示格式可供选择即 12 小时制和 24 小时制。系统默认的是 24 小时制。

例如：选择“设定日期”菜单，将会显示如下参考界面：



10.10 固件版本

查看机器的软件版本。

10.11 系统时间设置

系统时间设置界面，参考图片如下：

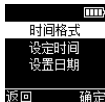

在此界面下，可设置系统的当前时间和系统时间显示格式。按停止键可以退出当前界面回到上一级菜单。

在此界面下，按“**左**”和“**右**”可以设置实时时间。按“菜单”键选择年、月、日；按“**左**”或“**右**”改变相应位置数值。选择“设置时间”菜单，将会显示如下参考界面：



在此界面下，按“**左**”和“**右**”可以设置实时时间。按“菜单”键选择时、分；按“**左**”或“**右**”改变相应位置数值。

10.12 定时录音设置

定时录音：先预设一个时间，当系统时间到达预设时间时，系统将会自动录音。在功能菜单中，选择“定时录音设置”菜单，再按“确定”键进入定时录音设置菜单。参考界面如下图所示：

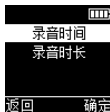

第一个功能是定时录音时间设置功能。定时录音时间设置参考界面如下图所示：

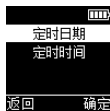

在此界面下，可选择“定时日期”和“定时时间”，当系统时间到达设定时间时，系统将自动开始录音。

录音时间长度设置功能：

可设置 30 分钟，60 分钟，120 分钟或者没限定录音时长来设置定时录音时长。时间长度设置参考界面如下：



10.13 指纹设置

在系统设置菜单界面，按上下曲键切换到“指纹设置”菜单，如下图；然后按“确定”键，进入指纹选择列表，“指纹开关”和“指纹重录”界面，按上下曲键选择，选择后按“确定”键确认。



1. 选择“指纹开关”——开，会进去录入指纹界面，如图 4，把需要录音入的手指头放在在指纹模块上，放置——移开——放置，循环操作，直到提示录入成功即可，如图 5，指纹录制好后，每次开机都会提示输入指纹解锁，连电脑和充电也需要解锁。选择“关”，即可关闭指纹，开机和充电不需要再输入指纹解锁。



图 4



图 5

2. 选择“指纹重录”会进入重新录制指纹界面，录制方法同上。



注意

- 如果本机没有录制指纹，选择指纹重录会提示无指纹。

10.14 恢复出厂设置

使用此功能，可以恢复到原出厂时的设置。参考图片如下：

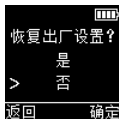

11 常见问题

此处列举了常见问题的解答，可帮助解决录音笔出现的简单问题。如果故障仍无法排除，请咨询经销商或访问我们的官方网站：

www.philips.com/support

11.1 无法启动录音笔

电池电量已耗尽请及时充电；或者滑动录音键不在停止录音的位置。

11.2 录音笔无法录音

超出录音笔允许的最大文件数量或录音笔存储空间已满。请删除部分录音或将其移至外部存储设备。

11.3 录音笔无法播放录音

- (1) 录音笔可能处于锁定模式 (HOLD)。将“锁定”开关推至“Off”位置。

- (2) 电池电量已耗尽，请充电。

12 技术参数

12.1 存储器

内置存储空间

参考录音时间(8GB)：日记模式模式约 145 小时，降噪模式模式约 48 小时，采访模式、会议模式、教学模式约 12 小时。

参考录音时间(16GB)：日记模式约 290 小时，降噪模式约 96 小时，采访模式、会议模式、教学模式约 24 小时。

内置存储器类型：NAND Flash 闪存

移动存储器 (PC)：是

12.2 尺寸和重量

宽 × 高 × 深：37.5×104.3×15.6(mm)

重量（含电池）：68.5g

12.3 系统要求

操作系统：Windows 10/Windows 8/Windows 7/Vista/XP/2000，
Mac OS X, Linux

接口：USB 接口

12.4 录音

日记模式：MP3 格式，比特率为 128kbps。

采访模式：WAV 格式，比特率为 1536kbps。

会议模式：WAV 格式，比特率为 1536kbps。

教学模式：WAV 格式，比特率为 1536kbps。

降噪模式：WAV 格式，比特率为 384kbps。

12.5 运行条件

温度：5℃ - 45℃

空气湿度：10% - 90%，不凝结

Content

I Welcome	34
1.1 Product features	34
2 Important Notice	35
2.1 Safety	35
2.2 Hearing protection	35
3 Your Digital Voice Recorder	36
3.1 What's in the box	36
3.2 Overview	36
4 Start to Use	38
4.1 Power on/off	38
4.2 Charging methods	39
4.3 Keypad lock (HOLD function)	39
4.4 Connecting to computer	39
5 Voice Recording	41
5.1 Description	41
6 Recording Settings	43
6.1 Recording scene	43

6.2 Recording indicator settings	43
6.3 Voice control settings	43
6.4 Monitoring settings	44
6.5 Segmented recording	44

7 Mobile APP instructions	45
7.1 Software download	45
7.2 Open sharing	45
7.3 Connection	46
7.4 Control device	47
7.5 Settings	49

8 Voice mode	50
8.1 Playback menu	51
8.2 Delete files	52

9 Music Mode	53
9.1 Playback menu	53
9.2 Delete files	55

10 System Setting	57
10.1 Backlight time	57
10.2 Automatic shutdown	57
10.3 Language selection	57
10.4 Button sound	58
10.5 Device ID	58

10.6 Memory selection	58
10.7 Disk information	58
10.8 Card information	59
10.9 Formatting the device	59
10.10 Firmware version	59
10.11 System time settings	59
10.12 Timed recording settings	60
10.13 Fingerprint settings	61
10.14 Factory reset	61
<hr/>	
11 FAQ	62
11.1 Failure to start the recorder	62
11.2 Failure to record	62
11.3 Recorder is unable to play	62
<hr/>	
12 Technical Parameters	63
12.1 Memory	63
12.2 Dimensions	63
12.3 System requirements	63
12.4 Recording	63
12.5 Operating conditions	63

I Welcome

Welcome to the world of Philips! We are honored by your choice and purchase of Philips' products. You can have Philips' comprehensive technical supports from our website, e.g. user's manuals, software downloading and warranty information etc.

www.philips.com

1.1 Product features

- Instant recording: Turn on the recording switch to record, and turn off the switch to save the recording.
- Digital noise reduction: Noise around the recording environment can be filtered effectively for clear recording. (This feature is recommended for noisy environment)
- Support fingerprint function.
- APP intelligent control: Realize remote control recording; support translation while recording.
- OTG to text: Recording file text conversion, easy to work and study.
- Record in the common formats of MP3 and WAV.
- Quick access to recordings and data by high speed USB 2.0.
- USB mass storage, ensuring the maximum compatibility.

2 Important Notice

2.1 Safety

- To avoid short circuits, never place the product in a location where it is exposed to moisture.
- Do not place the product near heated equipment or in direct sunlight.
- Please be careful not to pinch the cable, especially the plug.



Warning

- **Special Announcement:** Before using the product, please read the Manual carefully. Our Company shall not be held liable for any data loss due to incorrect manual operation or force majeure. We specially recommend that users make additional copies of the files in the device.
- Images are for reference only. Philips reserves the right to change the color / appearance / design / parameters/ product functions. Hardware, software and APP are subject to update without prior notice.

2.2 Hearing protection

Please observe the following guidelines when using headphones:

- Adjust to the appropriate volume and do not use the headphones for a long time.
- It is especially important to note that the volume should not be adjusted beyond the range that the ear can withstand.
- Do not adjust the volume to level that covers the sound from surrounding environment.
- Be careful or suspend the use of headphones in hazardous situations.
- Do not use headphones when driving car, riding bicycle or playing skateboard. Otherwise, it will result in a traffic accident and violate related laws and regulations.

3 Your Digital Voice Recorder

3.1 What's in the box:

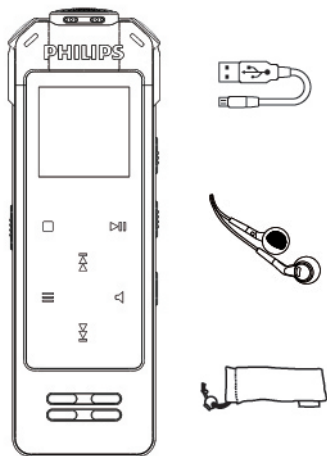

3.2 Overview:

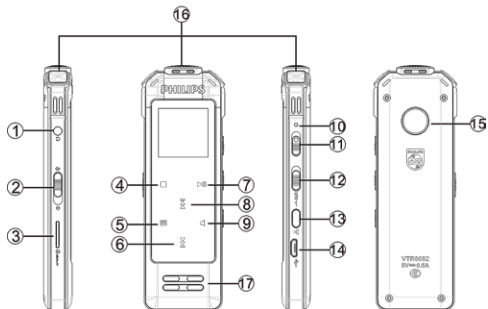

- ① Headphone jack
- ② Power on, Power off, Hold
- ③ TF card slot
- ④ Return / Switch folder touch button
- ⑤ Menu button
- ⑥ Next / Fast forward button
- ⑦ Play / Pause / Confirm button
- ⑧ Previous / Rewind button
- ⑨ Volume / Delete touch button
- ⑩ Indicator light
- ⑪ Recording / Save button
- ⑫ Instant noise reduction
- ⑬ Share / Reset button
- ⑭ USB port
- ⑮ Fingerprint module
- ⑯ Mic head
- ⑰ Speakers

4 Start to Use

4.1 Power on/off

Notice

- Please recharge the device for three hours before using it for the first time!

Slide down and hold Turn ON button for 2-3 seconds, the device will start or shutdown and then displays “PHILIPS”, as shown below:



Then the device enters the recording file to stop the playback interface, as shown below:



Long press the “Menu” button for about 2-3 seconds on the voice playback stop interface, and the device will return to the main interface. There are three modules in the main interface: voice mode, music mode and system settings.

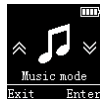

Notice

- In addition to recording and playback, in other interfaces, long press the “Menu” button for about 2-3 seconds to return to the main interface.

Reminder

- If the device cannot work normally, please make sure whether the device is not out of electricity.
- When the battery indicator “” is displayed, please charge the device promptly.

4.2 Charging methods

- (1) Connect the device to the PC by the USB cable, as shown in the left figure below.
- (2) Use a special charger to charge, as shown in the right figure below.

When using the above methods to recharge, the device enters the charging state. The battery indicator shows a battery icon changing from empty to full repeatedly, indicating that the device is recharging. Under normal circumstance, the device can be fully recharged in around 3 hours.

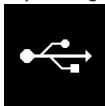

Notice

- While the device is connected to a computer, it cannot be operated manually.

4.3 Keypad lock (HOLD function)

- (1) Push up the Turn ON button to the lock position,

and lock all the buttons except the “Record” button. The “Lock Icon” is displayed briefly on the screen and then disappears, as shown below.

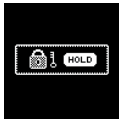

- (2) Slide the Turn ON button down to the middle position for cancelling the locking.

4.4 Connecting to computer

Whether TF card is inserted or not, the device can be used as a USB mass storage device to conveniently store, back up and move files. Connect the device to the PC by the USB cable, without installing any software, and the recording pen is automatically displayed as a portable device. The “Connect to Computer” icon is as shown below.

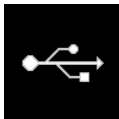



Reminder

- While moving files into or out of the device, please do not disconnect the device from the computer; Otherwise, it will result in file corruption or disk errors. When the recording pen is connected to PC, manual operation of the recording pen will not work.

5 Voice Recording

5.1 Description

When you first use the recording pen, please pay attention to the instructions in this section!

- (1) When the voice mode is stopped, press the “Stop” button to switch the folder.
- (2) Turn the recording button to the recording state to start recording; the recording indicator turns red and will last long; when recording, please aim the microphone at the source.
- (3) Press the “Play” button to pause recording, the recording indicator red light flashes, and the display shows “Pause”.
- (4) Press the “Play” button again to continue recording.
- (5) During recording, short press the “Menu” button to set the bookmark (INDEX), a recording file can be set 10 bookmarks, and can only be set up to 10 recording files.
- (6) Turn the recording button to the stop state to end the recording, and return to the stop playback interface of the current recording file.

The recording interface is shown below:



Recording Interface Illustration:

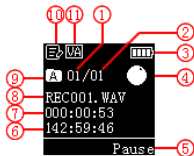

- | | |
|---|--------------------------------|
| ① Current recording file serial number | ⑦ Current duration |
| ② The number of current recording files | ⑧ Current file name |
| ③ Power display | ⑨ Current folder |
| ④ Current recording state | ⑩ Current recording background |
| ⑤ Pause | ⑪ Voice operated icon |
| ⑥ Remaining recording time | |



Notice

- When the battery icon is showing empty, it means low battery. The system will automatically shut down when the power is low. If the device is recording, the system will automatically save the recorded file then shut down. In case of low battery, please charge your device timely. The reference icon for low battery is shown as follows.



Reminder

- Before recording, please set the desired recording scene.
Note: In the stop state, press “Stop” to switch among the five folders of A, B, C, D and MUSIC. Recording files can be stored in the A, B, C and D folders, each of which can be stored 99 recording files. When there are 99 recording files in a folder, the system will store subsequently entered files in the next folder automatically. When all the four folders are full, please delete unnecessary files before recording.
- Test the recording first to ensure that the recording pen is set correctly.
- Each directory can store up to 99 files, with a total of 396 files for four directories (99 files x 4 directories).
- If the recording duration exceeds the usable capacity of the device or the number of files reaches the maximum of 396 files, the recording stops. Please delete part of recording or move it to a computer.
- Do not turn off the power while recording; otherwise it will result in loss of recorded information and file corruption.
- Please charge battery in advance if you need to record for a long time.

6 Recording Settings

In the voice playback stop interface, short press the menu button, a function menu list will pop up, including: recording scene, recording indicator, voice control settings, monitor settings, segmented recording. The relevant reference picture is shown below:



6.1 Recording scene

In the function menu, select the “Record Scene” menu and press the Menu button to enter the Recording Scene menu. There are five recording scenes to choose in the recording scene menu: “Diary mode, interview mode, conference mode, teaching mode, noise reduction mode”. The relevant reference picture is shown below:



Diary mode: MP3 format, bit rate is 128kbps.

Interview mode: WAV format, bit rate is 1536kbps.

Meeting mode: WAV format, bit rate is 1536kbps.

Teaching mode: WAV format, bit rate is 1536kbps.

Noise reduction mode: WAV format, bit rate is 384kbps.

Push up the side noise reduction button to turn on the noise reduction mode.

6.2 Recording indicator settings

In the function menu, select the “Record indicator” menu, press the confirm button to confirm, and then “On/Off” pops up. As shown below, when the recording indicator is off, the recording lamp will not light when recording.

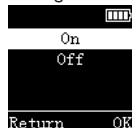

6.3 Voice control settings

In the function menu, select “Voice Settings”, the confirm button to confirm, and “Enable/Disable” pops up. After the selection is enabled, during recording, when the device

detects a sound, the recording pen will automatically start recording; without detecting the sound, the recording pen will automatically pause recording; when the sound is detected again, the recording pen will automatically start recording again. The voice control setting reference interface picture is as follows:



6.4 Monitoring settings

After the monitor function is turned on, insert the earphone and listen to it during recording. The monitor setting reference interface picture is as follows:



6.5 Segmented recording

In the function menu, you can set the segmentation recording. The segmentation time includes: off, 30 minutes, 60 minutes. After setting the segmentation time, the recording will automatically save and enter the next file to continue recording according to the set time. The reference interface for segmented recording selection is shown below:



7 Mobile APP instructions

7.1 Software download



(1) Download in China

For Android:

- Download by scanning QR code

For iOS :

- Download by scanning QR code
- Search for “VTR8062” in App Store and download

(2) Download in Foreign Countries

For Android:

- Download by scanning QR code

For iOS:

- Download by scanning QR code
- Search for “VTR8062” in App Store and download



Notice

- Choose “always allow” if there is a prompt that the application requires the permission of the mobile phone during installation.

7.2 Open sharing

When the device starts up, the sharing function will be automatically turned on as shown in Figure 1. If it is not connected after 5 minutes, the sharing function will automatically turn off. To connect to APP, long press the “Share” button for 2 seconds to open the sharing function. When the phone is connected, the “Share” icon will turn blue. As shown in Figure 2, long press the “Share” icon to turn off the sharing function.



Figure 1



Figure 2

Notice

Entering the charging mode or USB mode will turn off the sharing function.

7.3 Connection

(I) Connection for Android phone:

- Step 1: First open the "Sharing" function on the device;
- Step 2: Turn on phone's bluetooth, go to the mobile phone interface and click the "📶" icon of APP;
- Step 3: Open the phone APP and enter the search state, as shown in Figure 1. After the search, the device number will pop up, manually click the connection;
- Step 4: After the connection is successful, you will enter the APP interface, as shown in Figure 2. If the connection is unsuccessful, it will retrun to the interface as shown in Figure 3. At that time, you need to search the device again.



图 1



图 2



图 3

(I) Connection for iOS phone:

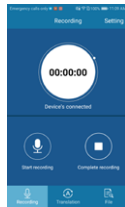
- Step 1: After downloading and installing the APP, open the APP directly on the phone interface and follow the prompts to connect;
- Step 2: Open the APP directly, the interface will prompt "Phone bluetooth is not turned on", at this time you need to go to the settings or drop-up shortcut to open the phone bluetooth; if you have turned on bluetooth, then open the APP will directly prompt "No device found, please click search";
- Step 3: After clicking the search, the prompt will pop up. Click the next step according to the instruction will automatically enter the search status and bring up

"PHILIPS verify..." to manually click verify;

- 3 After the manually verification is successful, find the device name in the settings according to the prompts, manually select the connection, after the connection is done, open the APP, it can be used when the upper left corner of the APP displays "Conneced".



Notice

1. After finding it, click the connection. If you can't connect multiple times, please turn off the app and reopen the Bluetooth and mobile sharing function of the mobile phone.
2. In the search interface, just click "Skip" in the upper right corner to enter directly the APP interface. Since it is not connected to the device, any function will not work at this time.

7.4 Control device

The APP can control device recording, real-time translation, files, settings, etc., making it easy to control the device in the distance.

7.4.1 Recording

After the APP is connected, enter the main interface of the APP. Click "Start Recording" to enter the following picture. In the recording state, the device also begins to record, and click "Complete Recording" to save the recording.

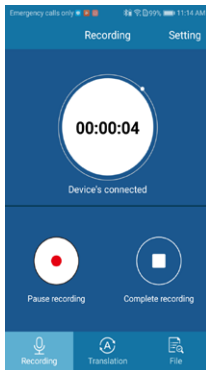

7.4.2 Real-time translation

Select “Real-time Translate” on the APP to enter the following interface. Click the button in the upper right corner to enter the real-time translation. In this interface, you can select “Intelligent Translation Assistant”, “Edit”, “Save”, “Sharing” and other functions.

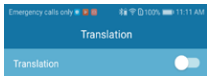

Chinese

Please open the real-time translation

英文(English)

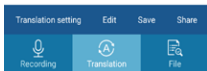

7.4.3 File

Open the file menu on the app, including “voice recording file”, “local file”, “transferred text”, as shown below:

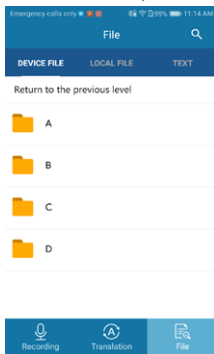

Recording pen file: Can upload the audio file in the device to the memory of the Android phone through the OTG line, and then translate it.

Local file: file recorded by APP

Translated text: storage for translated files



Notice

- The APP directs the recording, and the recording file is automatically saved after 1 hour.
- OTG is not supported on iOS phone.

7.5 Settings

In the main interface of the APP, click the “Setup Menu” in the upper right corner, and the following settings will pop up, such as “Recording Scene”, “Check Update”, “Disconnect Device” and so on.



Notice

- When the APP is connected to the device, you need to disconnect the device. Please save the recording first, then go to the setup menu to disconnect the device. You cannot directly turn off the APP; otherwise, the connection between the device and the APP will be abnormal;
- When the device is connected to the mobile phone APP, after the phone is connected, it is necessary to manually switch to the handset to answer the call;
- When the device and the mobile APP are connected beyond the valid distance, it needs to be connected manually to return to the valid distance.
- When in real time translation, please focus the sound source on the microphone and do not over the microphone with your hand, or it will affect the recognition effect when there is a barrier;
- Do not exceed the recognized effective distance when in real time translation.

8 Voice mode

In the main interface, you can use “▲” and “▼” to select the voice mode, then short press the “OK” button to confirm the entry. The voice stop interface reference picture is shown below:



Audio File Playback Interface Illustration:

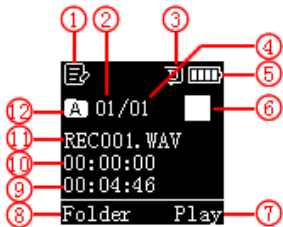

- | | |
|------------------------------|----------------------------------|
| ① Current recording type | ② Recording file serial number |
| ③ Loop mode | ④ Total number of recorded files |
| ⑤ Power display | ⑥ Current play state |
| ⑦ File playback | ⑧ Folder |
| ⑨ Total time of current file | ⑩ Current play time |
| ⑪ Current file name | ⑫ Current folder |

- (1) In the stop mode of the recording file, press the “Stop” button to select the desired folder.
- (2) Press the “▲” or “▼” button to select the file to play.
- (3) Press the “Play” button to start playback, and the play indicator light is constantly green.
- (4) Press the “Volume Key” to pop up the volume adjustment interface, and use the “▲” or “▼” key to adjust the volume.
- (5) Press the “Stop” button to end playback. In the stop playing state, long press the “Menu” button for about 2 seconds to return to the main interface.
- (6) During playback, press the play button to pause playback, the play indicator flashes green, and press the play button again to resume playback.
- (7) During playback, long press “▲” or “▼” to fast rewind or fast forward the current audio file.



Reminder

- Please charge battery in advance if you need to record for a long time.

8.1 Playback menu

After selecting the recording file to be played, short press the play button to play. During the playback, short press “Menu” to pop up the following play menu list: loop mode, repeat mode, replay times, replay gap, exit. The reference interface is as follows:



(1) Loop mode

During playback, press the “Menu” button to pop up the loop mode, you can select the desired loop mode. The reference interface is as shown below:



Directory Playback: Plays the files of the current folder in sequence.

Directory loop: Loop play the selected files in the directory.

Single loop: Loop play the file.

Shuffle: Randomly play the current folder directory file.

(2) Repeat mode

During playback, press the “Menu” button to pop up the “Repeat Mode” and press the confirm button to confirm. For the specific operation of the A-B Repeat, please refer to the A-B Repeat Operation section of the “Music Play” section.

(3) Replay times

Please refer to the Music Module Replay Times section for details.

(4) Replay gap

Please refer to the Music Module Repeat Times section for details.

(5) Play bookmarks

During the playback of the voice file, long press the “Menu” button to enter the bookmark menu, as follows on the left, select “Go to bookmarks” or “Delete bookmarks”, and short press the confirm button to enter the specific bookmark



interface, as shown in the right figure below:



8.2 Delete files

In the voice playback stop interface, long press the “volume” button, the function menu will pop up: Delete files and delete all.



In the delete interface, use the “” or “” button to select to delete a single file or all files; select “Yes” to confirm the deletion, select “No” to keep the file; press the confirm button to execute the command.

9 Music Mode

In the main interface, you can select the music module with the “” and “” button, then press the menu to enter the module; or in the voice mode, switch to the music folder via “the folder switch”. Music playback reference interface is shown below:

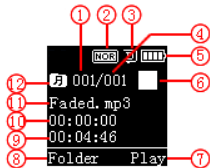
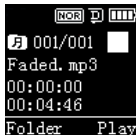

- | | |
|-------------------------------------|----------------------------------|
| ① The serial number of current file | ② Sound effects |
| ③ Loop mode | ④ Total number of recorded files |
| ⑤ Current battery level | ⑥ Current play state |
| ⑦ File playback | ⑧ Switch folder |
| ⑨ Total time of current file | ⑩ Current play time |
| ⑪ Current file name | ⑫ Current folder |

Notice

- Music files can only be played in the “MUSIC” folder.

Description of the music playback interface is as follow:

9.1 Playback menu

In the music folder playback interface, select the songs up and down by “” and “”, and short press the play button to play. Short press the menu button during playback, the following play menu list pops up: loop mode, sound mode, repeat mode, replay times, replay gap. The reference interface is shown below:



(1) Loop mode

During playback, press the “Menu” button to pop up the loop mode, you can select the desired loop mode. The reference interface is as shown below:



Directory Playback: Play the files in the selected directory in sequence, and stops playing automatically after all the files in the current directory are played.

Directory loop: Loop play the selected files in the directory.

Single cycle: Playing a selected track cyclically

Random play: Playing the files in the current selected catalog randomly

(2) Sound mode

Select the “Sound Mode” menu in the play menu list, and

press the Menu button to enter the sound mode. The sound mode includes the following sound effects: “Natural, Rock, Pop, Classic, Soft, Jazz, Subwoofer”. The reference interface is shown below:

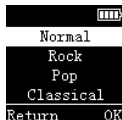

In the sound mode, you can use “▲” or “▼” to select the corresponding mode, and then press the confirm button to confirm.

(3) Sound mode and repeat mode

Select the “Repeat Mode” menu in the play menu list, and then press the confirm button to enter the repeat mode.

Set AB repeat



- Set the starting point of the repeat mode: In the playing state, short press the “Menu” button to enter the playback menu, then short press the “▲” or “▼” button to select the “Repeat Mode” option, and press the “OK” button to return to the playing state. At the time, play the “A” of the interface “AB” is flashing, waiting to confirm the repeat start point A, and short press “▼” to confirm the repeat start point A.
- Set the end point of the repeat mode: After setting the repeat start point A, the B of the playback interface “A-B”

flashes at this time, and then press the “” button to set the repeat end point B. At this time, the playback interface displays “A-B”. When the repeat icon is fixed to “AB”, the repeated playback between the AB points is started. After the set number of times is up, the “A” in the icon “AB” is flashed, waiting to confirm the starting point A, then the playback returns to normal playback. If you no longer need to do so, you can exit the repeat mode in the following ways.

- Cancel repeat: Short press the “Play” button to cancel the previous setting AB repeat and pause playback. Short press the “Stop” button to cancel the previous setting AB repeat and stop playing. Short press the “Menu” button to cancel the previous setting AB repeat and return to the normal playing state.

(4) Replay times



Select the "Replay Times" menu in the play menu list, then press the "Menu" button.

Enter the replay times setting menu and adjust the number of times with the “” or “” button.

The reference interface is shown below:



(5) Replay gap

The replay gap means the time interval between two repetitions. You can select the “Replay gap” menu in the play menu list and press the Menu button to enter the replay gap setting. Use the “” or “” button to adjust the replay gap.





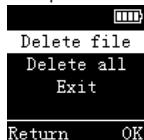

9.2 Delete files

In the music playback stop interface, long press the “Volume” button, a list of function menus will pop up, including: delete files, delete all, and exit. The following is a reference picture

for performing the delete operation:



On the left interface, use the “” or “” button to delete a single file or the used file; On the right interface, use the “” and “” button to select “Yes” to confirm deletion or “No” to retain the file; Press the “Enter” button to execute the order.

Notice

- Support list of music format:

Format	Yes/No (Support)
MP3	Yes
AIFF	No
ALAC	No
APE	Above 96KHZ is not supported
DSD	No
FLAC	Above 96KHZ is not supported
OGG	No
WMA	Above 48KHZ is not supported
WAV	Above 48KHZ is not supported

10 System Setting

Under the main menu, select System Setting Module, then press the Menu button to enter the System Setting interface. The related reference pictures of the system setting interface are as shown below, including: backlight time, auto power off, language selection, button sound, device ID, memory selection, disk information, card information, format device, firmware version, system time, timed recording, fingerprint settings, factory reset.



10.1 Backlight time

The backlight time is available to three different durations: 8 seconds, 20 seconds and constant brightness. If no operation to the device within the set time, the backlight will turn off. You can select constant light, and the backlight will be on constantly. The reference picture is as follow:



10.2 Automatic shutdown

There are four durations to choose for automatic shutdown: 5 minutes, 15 minutes, 30 minutes, and 60 minutes. If no operation to the device within the set time, the system will shut down. The reference interface is as follow:



10.3 Language selection

In the language selection menu, you can select a language as the system language. The reference interface of language selection is as follow:



10.4 Button sound

In the button sound setting menu, you can choose to turn the button sound on or off. After the button sound is turned off, the button sound will not work at any button operation. The reference picture is shown below:

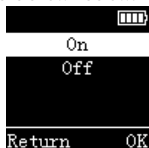

10.5 Device ID

The initial default device ID number is 0000. After the “Sharing” function is connected to the APP, an ID number will be generated. When using the APP, you must confirm whether the device is connected to the ID number for confirmation.

10.6 Memory selection

you can select the memory to be built-in or Micro-SD. The reference picture is shown below:

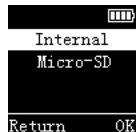

10.7 Disk information

Check the total storage and remaining space of the memory. The reference picture is shown below:

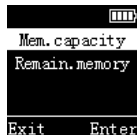

10.8 Card information

Check the total storage and remaining space of the inserted SD card. The reference picture is shown below:



10.9 Formatting the device

Format the device's memory. The reference picture is shown below:



10.10 Firmware version

Check the software version of the device.

10.11 System time settings

System time setting interface, the reference picture is as follows:



In this interface, you can set the system's current time and system time display format. Press the stop button to exit the current interface and return to the previous menu.

For example: Selecting the "Time Format" menu will display the following reference interface:

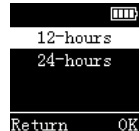

There are two time display formats available under this interface, namely 12-hour and 24-hour. The system default is 24-hour clock.

For example, when the "Date Setting" menu is selected, the following reference interface will be displayed:



In this interface, press “▲” and “▼” to set the real time. Press the “Menu” button to select the year, month and day; Press “▲” or “▼” to change the corresponding position value. Select the “Set Time” menu and the following reference interface will be displayed:



In this interface, press “▲” and “▼” to set the real time. Press the “Menu” key to select hour and minute; press “▲” or “▼” to change the value of the corresponding position.

10.12 Timed recording settings

Timed recording : first pre-set a duration, as system time is up to the pre-set time, the system automatically starts recording. In the function menu, select the “Timed Recording

Settings” menu, and then press the confirm button to enter the Timed Recording Settings menu. The reference interface is shown below:



The first function is the timed recording time setting function. The timing recording time setting reference interface is as shown below:



In this interface, you can select “Timed Date” and “Timed Time”. When the system time reaches the set time, the system will automatically start recording.

Recording duration setting function:

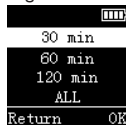

10.13 Fingerprint settings

In the system setting menu interface, press the up and down buttons to switch to the “Fingerprint Settings” menu, as shown below; then press the confirm button to enter the fingerprint selection list, “Fingerprint Switch” and “Fingerprint Re-recording” interface, press the up and down buttons to select , after selecting, press the confirm button to confirm;



1. Select “Fingerprint Switch”---Open, you will enter the fingerprint interface, as shown in Figure 4, put the finger that needs to be recorded into the fingerprint module, place it — move away—place, cycle operation until prompted If the entry is successful, as shown in Figure 5, after the fingerprint is recorded, each time you turn on the phone, you will be prompted to enter the fingerprint to unlock it. Even the computer and charging need to be unlocked. Select “Off” to turn off the fingerprint, and you don't need to enter your fingerprint to unlock it when you turn it on and charging.



Figure 4



Figure 5

2. Select “Fingerprint Re-recording” to enter the re-recording fingerprint interface. The recording method is the same as the above.



Notice

- If the device, does not record a fingerprint, selecting fingerprint re-recording will prompt no fingerprint.

10.14 Factory reset

With this function, you can restore to the original factory settings. The reference picture is shown below:

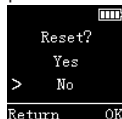

11 FAQ

This section has listed all the frequently asked questions to help you address the simple issues during use of the voice/video recorder. If such issues persist, please consult our dealers or visit our official website: www.philips.com/support

11.1 Failure to start the recorder

If the battery is exhausted, please charge it in time; or slide the recording button to stop recording.

11.2 Failure to record

The device exceeded the maximum file number or the device's storage is full. Please delete some recordings or move them to other storage devices.

11.3 Recorder is unable to play

- (1) The device may be in the lock mode (HOLD). Push the "lock" switch to the "Off" position.

- (2) The battery is used up, please charge your device.

12 Technical Parameters

12.1 Memory

Built-in Memory

Reference recording time (8GB): The diary mode is about 145 hours, the noise reduction mode is about 48 hours, and the interview mode, conference mode, and teaching mode are about 12 hours respectively.

Reference recording time (16GB): The diary mode is about 290 hours, the noise reduction mode is about 96 hours, and the interview mode, conference mode, and teaching mode are about 24 hours respectively.

Type of built-in memory: NAND Flash (flash memory)

Portable storage device (PC): Yes

12.2 Dimensions

Width × height × Length: 37.5×104.3×15.6(mm)

Weight (including Battery): 68.5g

12.3 System requirements

Windows 7/Vista/XP/2000, Mac OS X, Linux

Port: USB 2.0

12.4 Recording

Diary mode: MP3 format, bit rate is 128kbps.

Interview mode: WAV format, bit rate is 1536kbps.

Meeting mode: WAV format, bit rate is 1536kbps.

Teaching mode: WAV format, bit rate is 1536kbps.

Noise reduction mode: WAV format, bit rate is 384kbps.

12.5 Operating conditions

Temperature: 5°C–45°C

Humidity: 10%-90%, non-condensing

Warranty card

质保书

1

year warranty

一年质保

Type: VTR8062

Serial nr:

Date of purchase

购买日期

Dealer's name, address and signature

销售商名称、地址及签字

www.philips.com/welcome

This document is printed on chlorine free produced paper

Data subject to change without notice

This product was brought to the market by Speech Processing Solutions GmbH or one of its affiliates, further referred to in this document as SPS, which is the manufacturer of the product. SPS is the warrantor in relation to the product with which this booklet was packaged.

For China only
只限中国地区

Printed in China



