

Quick Start Guide

DVP3980
DVD Video Player

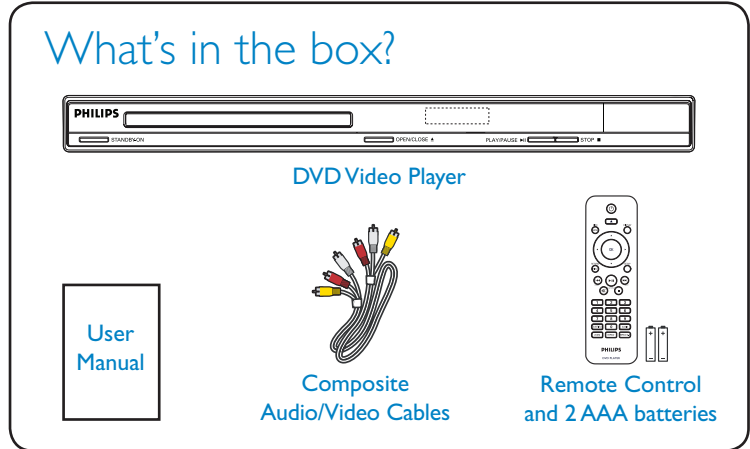

Connect

Basic Audio/Video Connections

Composite Video CVBS (Good Quality)

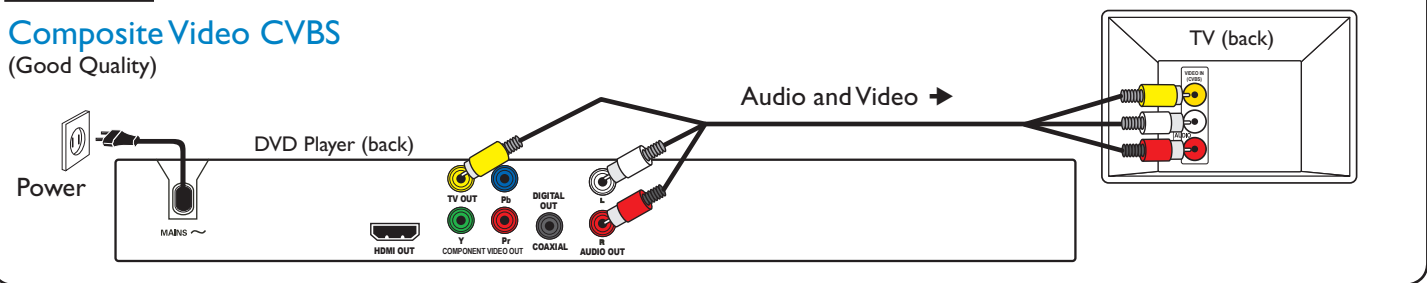

OR

Component Video (Better Quality)

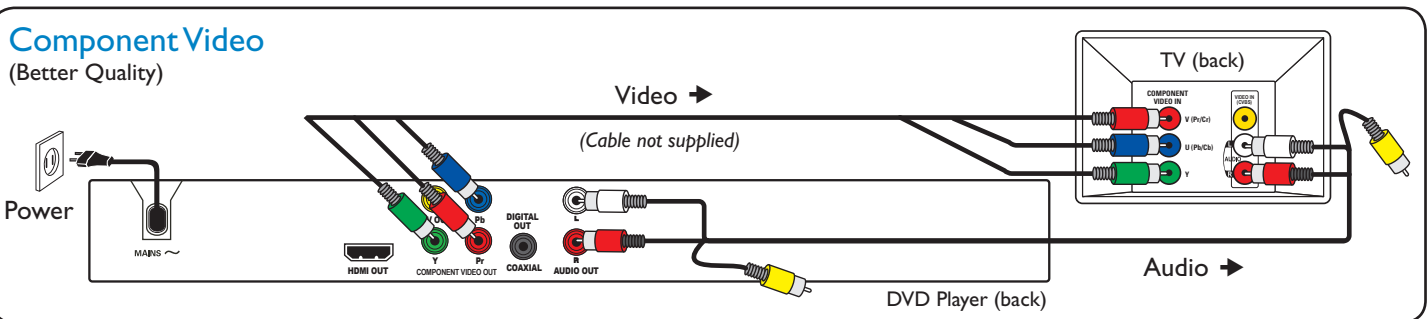

OR

HDMI (Best Quality)

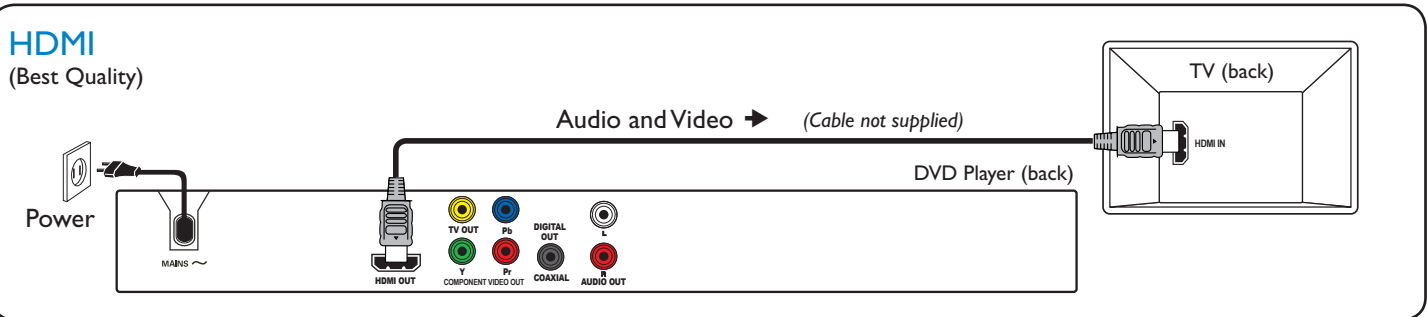

OR

RF Modulator

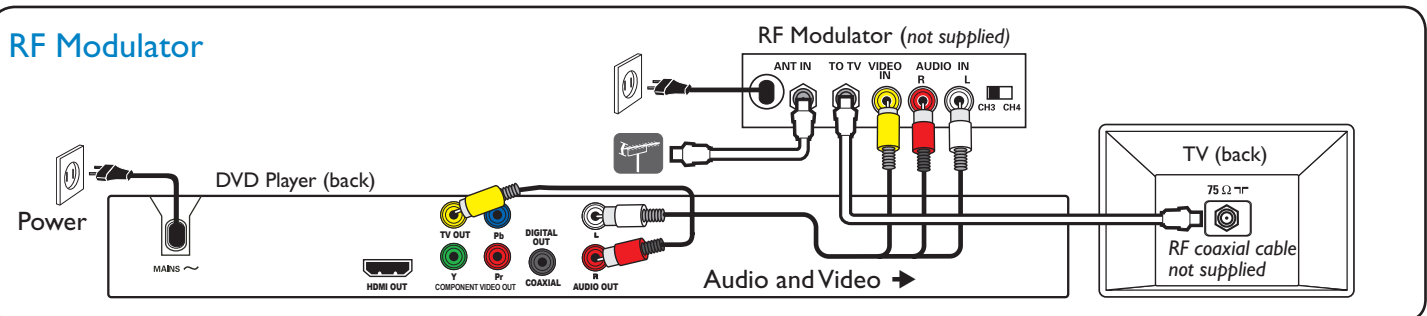

2 Set up

A Finding the viewing channel

- 1 Press **STANDBY ON** on this unit to turn it on.

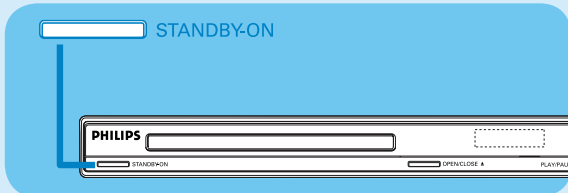

- 2 Turn on the TV. Use the TV's remote control to select the correct viewing channel.

Note To search for the correct viewing channel, press the Channel Down button on the TV's remote control repeatedly (or AV, SELECT,  button) until you see the Video In channel. If you are using a RF modulator, set the TV to channel 3 or 4.

B Select the display language on the screen

- 1 Press **SETUP**.
The { General Setup Page } appears.

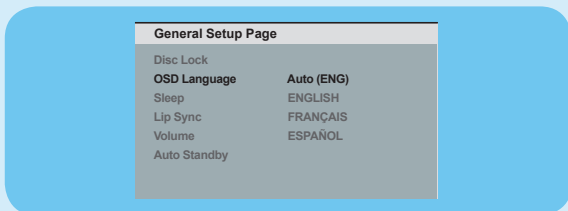

- 2 Use **▲▼** keys to select { OSD Language } and press **▶**.
- 3 Use **▲▼** keys to select a language and press **OK** to confirm. (For Philips 'EasyLink' TV, { Auto } must be selected.)
- 4 Press **SETUP** to exit.

Note The language set here is only for the menus that are shown on the TV while operating this unit, not for the DVD disc menu.

There are various setup options (Audio Setup, Video Setup, Preference Setup) available on this unit. Refer to the user manual for more information.

Need help? User Manual

See the user manual that came with your Philips DVD Player.

Online

Register your product and get support at www.philips.com/welcome.

Hotline

Call 1-866-771-4018 for our operators.

3 Enjoy

A Start disc playback

- 1 Playback may start automatically when a disc has been loaded in the disc tray.

Note If a disc menu appears on the TV, use **▲▼◀▶** keys to navigate in the DVD menu.

- 2 Press **▶||** to start playback.
- 3 To stop playback, press **■**.

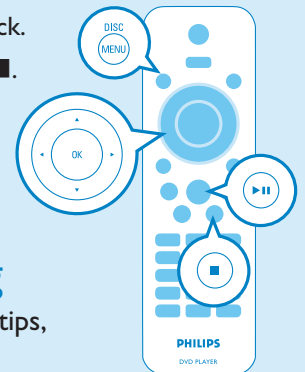

Troubleshooting

For more troubleshooting tips, see the user manual.

No power

- Check if the AC power cord is properly connected.
- Press the STANDBY-ON on the top panel of this unit to turn on the power.

No picture

- Check connection to TV and ensure the plugs are firmly in place.

No sound or distorted sound

- Check audio connections and make sure that the connected audio device is turned on.
- For HDMI connection, check if your TV's HDMI or Digital setting is set to ON. Contact your TV manufacturer for detailed information.

Remote control does not work

- Check the batteries are loaded correctly or replace the batteries with new ones.
- Reduce the distance between the remote control and this unit.
- Point the remote control directly toward the IR sensor.

2008 © Philips Consumer Electronics
Philips and Philips Shield are used under license of
Koninklijke Philips Electronics
P&F USA, Inc. PO Box 672768 Marietta, GA 30006
All rights reserved.

Printed in China
sgjy-0851/F7_03

