

**PHILIPS**

**AVENT**

SCD891



# User manual

# Contents

<b>Introduction</b> .....	<b>4</b>
<b>General description</b> .....	<b>4</b>
<b>Important safety information</b> .....	<b>5</b>
<b>IMPORTANT</b> .....	<b>5</b>
<b>Preparing for use</b> .....	<b>7</b>
Baby unit.....	7
Parent unit .....	7
Provision of security updates .....	8
<b>Using the baby monitor</b> .....	<b>9</b>
Linking parent unit and baby unit.....	9
Positioning the baby monitor.....	10
<b>Features and settings</b> .....	<b>12</b>
Volume.....	12
Brightness.....	13
Sound level lights.....	13
Modes .....	14
Nightlight.....	17
Soothing sounds .....	18
Talk-back.....	20
Menu features.....	20
Belt clip.....	26
<b>Cleaning and maintenance</b> .....	<b>27</b>
<b>Storage</b> .....	<b>28</b>
<b>Ordering accessories</b> .....	<b>28</b>
<b>Recycling</b> .....	<b>28</b>
Environmental information.....	28
Removal of built-in rechargeable battery .....	29
<b>Support</b> .....	<b>29</b>
<b>Frequently asked questions</b> .....	<b>30</b>
<b>Wall mount</b> .....	<b>36</b>

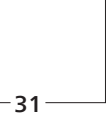
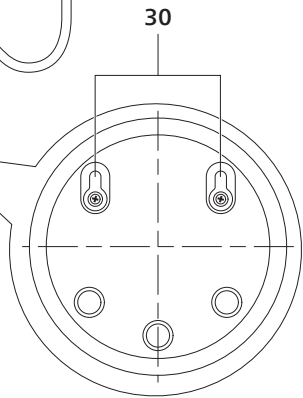
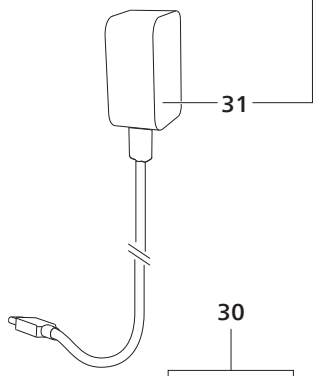
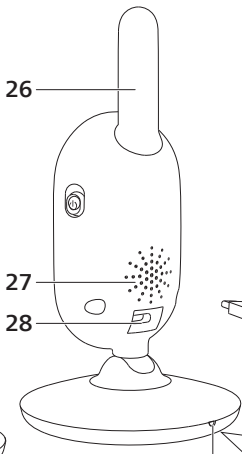
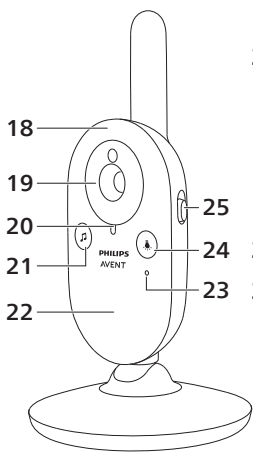
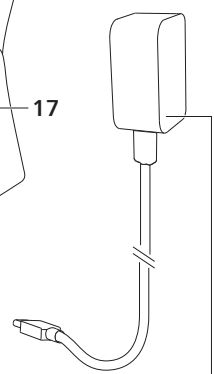
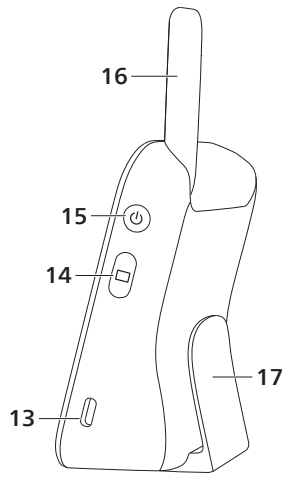
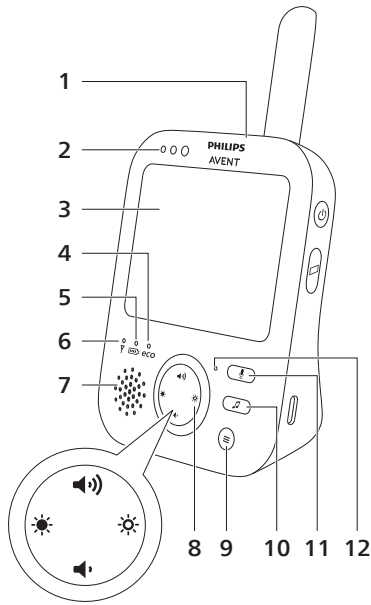

31

# Introduction

Congratulations on your purchase and welcome to Philips Avent! To fully benefit from the support that Philips Avent offers, register your product at [www.philips.com/welcome](http://www.philips.com/welcome).

The Philips Avent video baby monitor provides you with round-the-clock support and it allows you to see your baby day and night from anywhere in the house. The latest digital technology guarantees clear sound and the clearest image of your baby. This gives you an additional sense of security without entering your baby's room and disturbing its sleep.

## General description

- 1 Parent unit
- 2 Sound level lights
- 3 Display
- 4 Eco light
- 5 Battery status light
- 6 Link light
- 7 Speaker
- 8 Control button (menu navigation/volume/brightness)
- 9 Menu button
- 10 Soothing sound button
- 11 Talk-back button
- 12 Microphone
- 13 Socket for power adapter
- 14 Mode button
- 15 On/off button
- 16 Antenna
- 17 Belt clip
- 18 Baby unit
- 19 Camera
- 20 Power on light
- 21 Soothing sound on/off button
- 22 Nightlight
- 23 Microphone
- 24 Nightlight on/off button
- 25 On/off slide
- 26 Antenna
- 27 Speaker
- 28 Socket for power adapter
- 29 Temperature sensor
- 30 Wall mounting holes
- 31 Adapter (2x)

# Important safety information

Read this important information carefully before you use the appliance and save it for future reference.

## IMPORTANT

**This baby monitor is intended as an aid. It is not a substitute for responsible and proper adult supervision and should not be used as such.**

Never leave your baby alone in your home. Always make sure there is someone present to look after the baby and take care of its needs.

### Disclaimer

Please note that you use this baby monitor at your own risk. Koninklijke Philips N.V. and its subsidiary companies are not responsible for the operation of this baby monitor or your use of it and therefore do not accept any liability in connection with your use of this baby monitor.

### Danger

- Never immerse any part of the baby monitor in water or any other liquid. Do not place the appliance where water or any other liquid can drip or splash onto it. Never use the baby monitor in moist places or close to water.
- Never put any object on top of the baby monitor and do not cover it. Do not block any ventilation openings. Install according to the manufacturer's instructions.

### Warning

- Long cable. Strangulation hazard!
- Check if the voltage indicated on the adapter corresponds to the local mains voltage before you connect the appliance.
- Do not modify or cut off any part of the adapter and its cord, as this causes a hazardous situation.
- Only use the adapter supplied.
- If the adapter is damaged, always have it replaced with one of the original type in order to avoid a hazard.
- This appliance can be used by children aged from 8 years and above and persons with reduced physical, sensory or mental capabilities or lack of experience and knowledge if they have been given supervision or instruction concerning use of the appliance in a safe way and understand the hazards involved. Children shall not play with the appliance. Cleaning and user maintenance shall not be made by children without supervision.
- Protect the mains cord from being walked on or pinched particularly at plugs, convenience receptacles, and the point where they exit from the appliance.

- Make sure that you place the baby monitor in such a way that its cord does not obstruct a doorway or passage. If you place the baby monitor on a table or low cabinet, do not let the mains cord hang over the edge of the table or cabinet. Make sure the cord does not lie on the floor where it presents a tripping hazard.
- Keep the packaging materials (plastic bags, cardboard buffers, etc.) out of the reach of children, as they are not a toy.
- To prevent electric shock, do not open the housing of the baby unit or parent unit.

### **Battery safety instructions**

- Only use the product for its intended purpose. Read this information carefully before you use the product and its batteries and accessories, and save it for future reference. Misuse can lead to hazards or serious injuries. Accessories supplied may vary for different products.
- Only use original Philips accessories and consumables. Only use detachable supply unit ASSA105x-050100 (x = B or C or E or J) series.
- Charge, use and store the product at a temperature between 0 °C and 40 °C.
- Keep product and batteries away from fire and do not expose them to direct sunlight or high temperatures.
- If the product becomes abnormally hot or smelly, changes colour or if charging takes longer than usual, stop using and charging the product and contact Philips.
- Do not place products and their batteries in microwave ovens or on induction cookers.
- Do not open, modify, pierce, damage or dismantle the product or battery to prevent batteries from heating up or releasing toxic or hazardous substances. Do not short-circuit, overcharge or reverse charge batteries.
- If batteries are damaged or leaking, avoid contact with the skin or eye. If this occurs, immediately rinse well with water and seek medical care.

### **Caution**

- Do not install the appliance near any heat sources such as radiators, heat registers, stoves or other apparatus (including amplifiers) that produce heat.
- Make sure that your hands are dry when you handle adapters, plugs and the mains cord.
- All required markings on the baby unit, parent unit and power adapter are located on the bottom of the baby unit, parent unit and power adapter.

### **Declaration of conformity**

Hereby, Philips Consumer Lifestyle B.V. declares that radio equipment types SCD881, SCD882, SCD891 and SCD892 are in compliance with the essential requirements and other relevant provisions of Directive 2014/53/EU. The full text of the EC Declaration of Conformity (DoC) is available online at [www.philips.com/support](http://www.philips.com/support).

### **Electromagnetic fields (EMF)**

This product complies with all applicable standards and regulations regarding exposure to electromagnetic fields.

# Preparing for use

## Baby unit

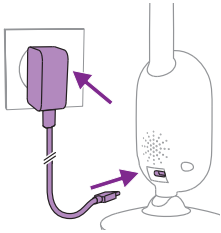

Put the power adapter in the baby unit and the adapter in the wall socket.

## Parent unit

The parent unit runs on a built-in rechargeable Li-ion battery. Follow the below steps to charge the parent unit:

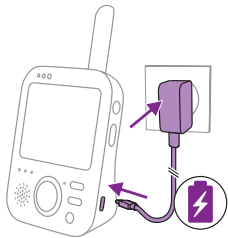

Put the power adapter in the parent unit and put the adapter in the wall socket.

The battery status light turns orange to indicate that the appliance is charging.



Note: When the parent unit is off and the power adapter is plugged in to the parent unit, the display goes on and the charging icon appears on the display to show that the appliance is charging. After 5 seconds, the display will turn off.



When the battery is fully charged, the battery status light turns green continuously.

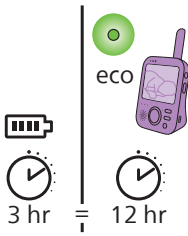

When you charge the parent unit for 3 hours, it can be used cordlessly for approx. 12 hours in Eco mode.

If the parent unit is switched on during charging, charging takes approximately twice as long.

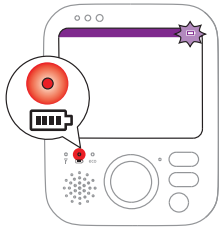

When the rechargeable battery of the parent unit is almost empty, the battery status light turns red and the parent unit beeps.

If the battery is completely empty and the parent unit is not connected to the mains, the parent unit automatically switches off and loses contact with the baby unit.

**Note:** The built in rechargeable battery cannot be removed from the product.

**Note:** The battery gradually and very slowly discharges, even when the parent unit is switched off.

**Tip:** To save battery, switch off the parent unit when you do not use it.

**Note:** We advise you to keep the parent unit connected to the mains during the whole night. If the battery of the parent unit runs low during the night, the parent unit beeps and this may wake you up.

## Provision of security updates

We continuously monitor the security of the software used in the product. If necessary, security updates will be provided through software updates. Software updates may also be provided to offer bugfixes and performance improvements, or to introduce new product features. Updates may be provided to the baby unit and parent unit firmware. Updates are wirelessly delivered to the product without the usage of special cables or equipment.

Philips will provide the necessary updates for a period of at least two years after the delivery of the product.



# Using the baby monitor

## Linking parent unit and baby unit

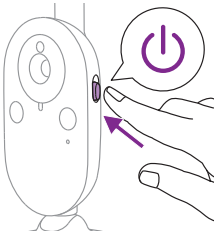

- 1 Push the on/off slide on the baby unit upwards to the ON position.

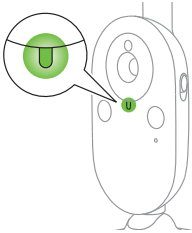

- 2 When the baby unit is on, the power-on light on the baby unit lights up green.

Note: The power-on light on the baby unit always lights up green, even when there is no connection with the parent unit.

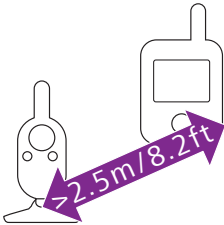

- 3 Make sure that the parent unit and the baby unit are at least 2.5 meters/ 8.2 feet away from each other to avoid acoustic feedback.

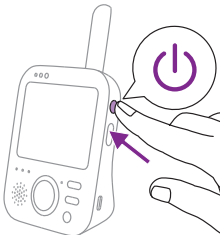

- 4 Press the on/off button on the parent unit for 1 second to switch on the parent unit.



The display goes on, the linking image appears on the display and the link light lights up red. The parent unit starts to search for the baby unit.

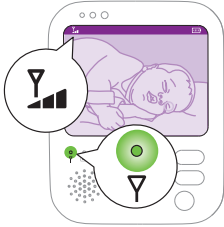

When the parent unit and baby unit are linked, the link light lights up green on the parent unit and one or more bars appear on the display.

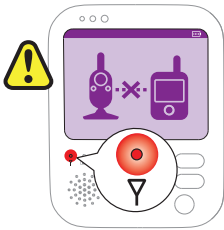

**Note:** It takes less than 10 seconds to establish the link between the parent unit and the baby unit.

When the baby unit is turned off, the parent unit will show the out of range image. Make sure that the baby unit is switched on.

If no connection has been established, the link light turns red, the parent unit beeps every 20 seconds and the out-of-range image appears on the display.

## Positioning the baby monitor

**Warning:** The cord of the baby unit presents a potential strangulation hazard. Make sure that the baby unit and its cord are at least 1 meter / 3.5 feet away from your baby. Never place the baby monitor inside the baby's bed or playpen.

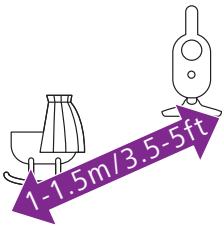

- 1 For optimal sound detection, make sure that the baby unit is no further than 1.5 meter / 5 feet away from the baby. Make sure that the baby unit is at least 1 meter / 3.5 feet away from the baby because of potential strangulation hazard.

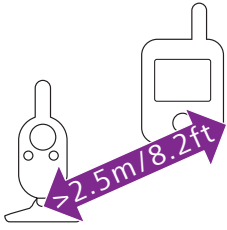

- 2 Place the parent unit within the operating range of the baby unit. Make sure it is at least 2.5 meters / 8.2 feet away from the baby unit to avoid acoustic feedback.

Note: If you use a cordless phone, wireless video, Wi-Fi network, microwave oven or Bluetooth on 2.4 GHz and you experience interference on either the parent unit or baby unit, move the parent unit until there is no more interference.

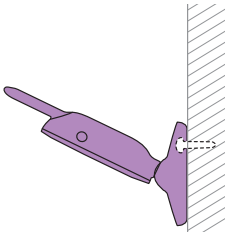

- 3 There are two ways to position the baby unit:
- a Place the baby unit on a stable, level and horizontal surface.
  - b Mount the baby unit to the wall with screws.

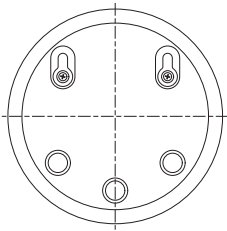

Tip: The wall mount template (see 'Wall mount') to mount the baby unit to the wall can be found at the end of this user manual.

Tip: Use the provided template to mark the exact location of the screw holes on the wall.

Tip: Position the baby unit at a higher level to get a good overview of the baby's bed or playpen.

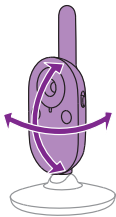

- 4 Adjust the baby unit in a way that ensures the best visibility of your baby. The baby unit can be rotated to position it in the desired way.

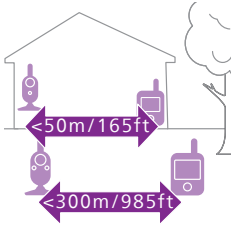

## Operating range

The operating range is up to 50 meters / 165 feet indoors and 300 meters / 985 feet outdoors. The operating range of the baby monitor varies depending on the surroundings and factors that cause interference. Wet and moist materials cause so much interference that the range loss is up to 100 %.

Dry materials	Material thickness	Loss of range
Wood, plaster, cardboard, glass (without metal, wires or lead)	< 30 cm (12 in)	0-10 %
Brick, plywood	< 30 cm (12 in)	5-35 %
Reinforced concrete	< 30 cm (12 in)	30-100 %
Metal grilles or bars	< 1 cm (0.4 in)	90-100 %
Metal or aluminium sheets	< 1 cm (0.4 in)	100 %

## Features and settings

### Volume

You can adjust the speaker volume of the parent unit to the level you prefer.

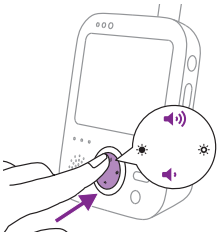

- 1 Press the top or bottom part of the control button to adjust the volume.



**Tip:** Make sure that the volume is adapted to the current conditions. Under noisy conditions, the vibration alert can be turned on as well.

The volume bar appears on the display to show the selected volume.

**Note:** If the volume is set to a high level, the parent unit consumes more power.

**Note:** When the volume bar is at its minimum, the volume is muted. The parent unit shows a mute icon in the status bar and you will only receive alerts and video from the parent unit.

## Brightness

You can adjust the brightness of the display and lights on the parent unit to the level you prefer.

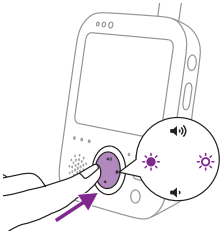

- 1 Press the left or right part of the control button to adjust the brightness. This will adjust both the brightness of the display and lights of the parent unit at the same time.



The brightness bar appears on display to show the selected brightness. There are five brightness levels in the brightness bar.

The display has five levels of brightness. The lights of the parent unit have two levels of brightness. If the brightness bar is at the minimum and second level, the brightness of the lights is dimmer. If the brightness bar is at the third level to maximum, the brightness of the lights is brighter.



Note: If the brightness is set to a high level, the parent unit consumes more power.

## Sound level lights

The parent unit continuously monitors the sound level in your baby's room, and the sound level lights on the parent unit let you know if there is any sound picked up in the baby room.



As long as no sound is detected, the sound level lights are out.



When the baby unit picks up a sound, one or more sound level lights on the parent unit light up green. The number of lights that go on depends on the loudness of the sound picked up by the baby unit. The louder your baby cries, more sound level lights light up green.

## Modes

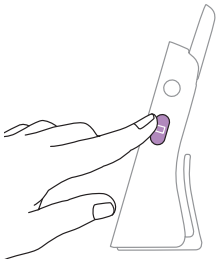

This baby monitor has four different modes that allows you to choose how you want to look after your baby: Video, Audio, Vox and Eco.

With the baby monitor on, you can switch between these 4 different modes by pressing the mode button on the side of the parent unit. The display shows the selected mode. The selected mode is also indicated in the status bar. When turning on the device, the mode that was last used will be active.

## Video mode



Press the mode button on the side of the parent unit to select the Video mode.



When the Video mode is activated, the screen is always on, so you can see your baby. All sounds are directly transmitted to the parent unit.

**Note:** Set the sensitivity level to 'very high' to have continuous sound on the parent unit. Please see section 'Sensitivity' for more information.



If your baby cries, the sound level lights light up green. As long as no sound is detected, the sound level lights are off.

## Audio mode



- 1 Press the mode button on the side of the parent unit to switch to Audio mode.



When the Audio mode is activated, the display of the parent unit switches off. After 3 seconds the display will completely turn off and the status bar will disappear.

**Note:** The status bar is not visible when the display is off.



**Note:** The link light shows that the parent unit is still on and connected to the baby unit.

**Note:** When sensitivity level is not set to 'very high', low sounds will be muted.

**Note:** Set the sensitivity level to 'very high' to have continuous sound on the parent unit. Please see section 'Sensitivity' for more information.

All sounds are constantly transmitted to the parent unit. If your baby cries, the display of the parent unit is still off, but the sound level lights light up green and the sounds detected by the baby unit are transmitted to the parent unit. As long as no sound is detected, the sound level lights are off.

## Vox mode



- 1 Press the mode button on the side of the parent unit to switch to Vox mode.

Note: When the display is on, the selected mode is shown in the status bar. The status bar is not visible when the display is off.



When the Vox mode is activated, the display and sound of the parent unit switch off, if there is no sound detected for 20 seconds.



When sound is picked up by the baby unit, the display and sound of the parent unit switch on immediately. The sounds are transmitted to the parent unit and the sound level lights light up green. As long as no sound is detected, the sound level lights are off.

Note: The minimum sound level to activate sound and display is defined by the sensitivity setting.

## Eco mode



- 1 Press the mode button on the side of the parent unit to switch to Eco mode.

Note: When the display is on, the selected mode will be visible in the status bar. The status bar is not visible when the display is off.

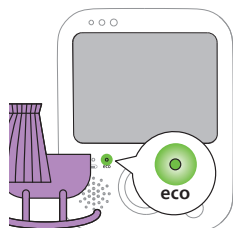

When the Eco mode is activated the display and sound of the parent unit switch off when no sound is detected for 20 seconds. The Eco light lights up green to indicate that the Eco mode is activated. During Eco mode the display and sound transmissions are turned off.





When sound is picked up by the baby unit, the display and sound of the parent unit switch on immediately. The sounds are transmitted to the parent unit and the sound level lights light up green. As long as no sound is detected, the sound level lights are off.

Note: The minimum sound level to activate sound and display is defined by the sensitivity setting.

## Nightlight

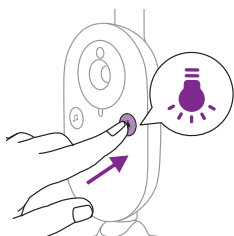

- 1 Press the nightlight on/off button on the baby unit to switch on the nightlight feature.

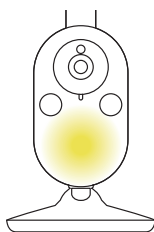

The nightlight of the baby unit goes on.

Note: It is not possible to control the nightlight from the parent unit. You can only switch the nightlight on or off on the baby unit.

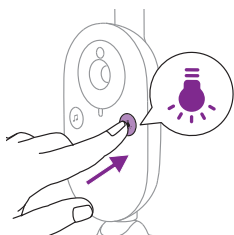

- 2 Press the nightlight on/off button again to switch off the nightlight.

# Soothing sounds

You can activate the soothing sound feature either from the parent unit or from the baby unit.

To activate the soothing sound feature from the parent unit, follow the instructions below:

## Soothing sound selection

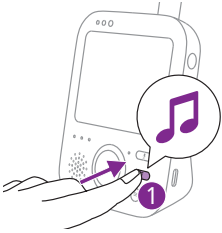

- 1 Press the soothing sound button on the parent unit to open the menu for soothing sounds.

Note: Pressing the soothing sound button while the soothing sound menu is already open, will close the menu.

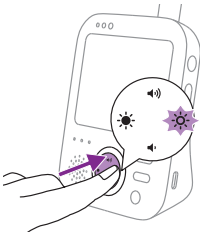

- 2 Press the right part of the control button to enter the list of soothing sounds.

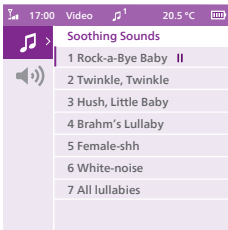

- 3 Press the top or bottom part of the control button to scroll through the list of soothing sounds.

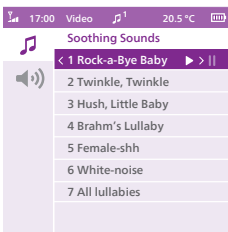

- 4 Press the right part of the control button to play a specific soothing sound. If you want to pause the soothing sound, press the right side of the control button again.
- 5 The status bar of the parent unit shows the number of soothing sounds that are being played and repeated.



The soothing sound starts to play on the baby unit and it is repeated continuously for approximately 15 minutes.

**Tip:** To repeat all lullabies that are available, select All lullabies in the list.

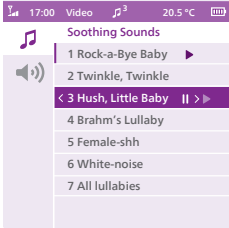

- 6 To select another soothing sound, scroll up or down with the control button to select another soothing sound from the list. Press the right part of the control button to start the selected soothing sound.
- 7 To stop the soothing sound, press the soothing sound button on the parent unit. To pause the soothing sound that is currently playing, press the right part of the control button one more time.

### Soothing sound volume

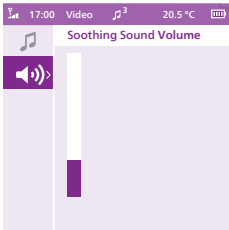

- 1 Press the soothing sound button and then press the bottom of the control button to select the volume options of the soothing sound menu. Press the right part of the control button to access the soothing sound volume levels.

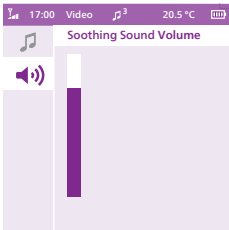

- 2 Press the top or bottom part of the control button to adjust the volume.

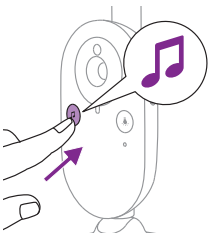

To activate the soothing sound feature from the baby unit, press the soothing sound on/off button on the baby unit.



The latest selected soothing sound on the parent unit starts to play on the baby unit and is repeated continuously for approximately 15 minutes. To stop the soothing sound on the baby unit, press the soothing sound on/off button on the baby unit.

## Talk-back

You can use the talk-back button on the parent unit to talk to your baby.



- 1 Press and hold the talk-back button on the parent unit.
- 2 Talk clearly into the microphone at the front of the parent unit from a distance between 15-30cm /0.5-1ft.

As long as the talk-back button is pressed, there is an open sound connection to the baby unit. The display of the parent unit shows the talk-back icon, indicating the active connection.

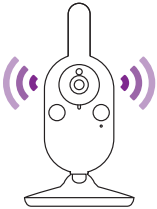

- 3 Release the talk-back button when you have finished talking.

Note: While the talk-back button is pressed, the parent unit cannot receive sounds from the baby unit, and any soothing sounds being played will be stopped. However, upon releasing the talk-back button, the soothing sound, if already turned on, will continue playing.

## Menu features

All features described in the following sections can be operated through the menu of the parent unit.

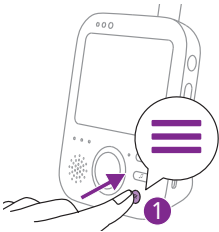

- 1 Press the menu button to enter the menu.

Note: When pressing the menu button again, you will leave the menu.

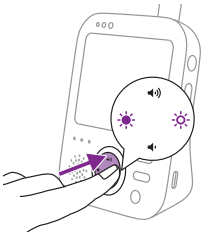

- 2 Use the control button to navigate through the menu. The selected menu item is highlighted purple.

Note: If you are already in one of the sub menus and you want to switch between menu features, press the left part of the control button to navigate back to the main menu.

- 3 Press the top or bottom part of the control button to scroll through the different menu items.

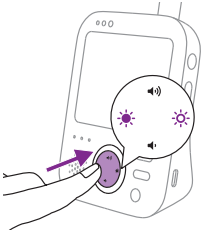

When you are navigating through the menu features and do not want to save any change, press the menu button. You will leave the menu without changing any settings.

Note: If you are in the menu but do not press a button for 5 seconds, the menu will exit without saving changed settings.

## Zoom

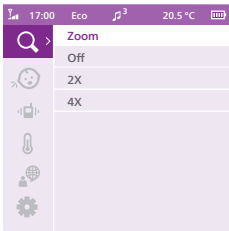

- 1 Press the right part of the control button to enter the zoom menu.

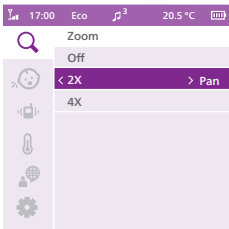

- 2 Press the bottom part of the control button to choose the zoom option.

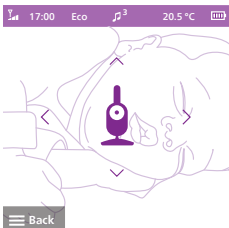

- 3 To adjust the video image, press the right part of the control button. You can use the top/bottom/right/left part of the control button to choose what image will be shown on the parent unit.
- 4 Press the menu button to save the new setting. The image is automatically saved after 5 seconds.
- 5 Go to the zoom menu and turn off the zoom function, if you want to zoom out the image on the parent unit.

## Sensitivity

The sensitivity level of the baby unit defines what you hear through the parent unit. When the level is set high, you will hear many sounds, including soft background sounds. When the sensitivity level is set low, you will hear only the louder sounds.

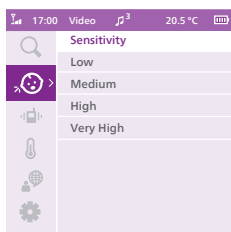

- 1 Press the right part of the control button to access the sensitivity levels.

Note: When pressing the left part of the control button again, you will leave the menu.

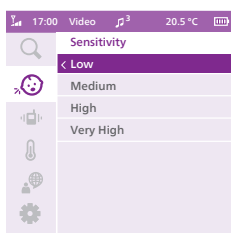

- 2 Press the top or bottom part of the control button to select the desired sensitivity level.

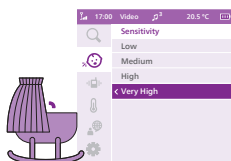

If your baby only makes soft sounds, the sensitivity of the baby unit needs to be set to a high sensitivity level on the parent unit.

The louder your baby sounds, the lower the sensitivity can be set on the parent unit.

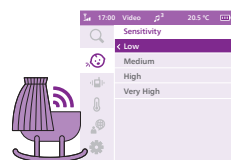

Note: In Audio and Video mode, you will have continuous sound when the sensitivity level is on 'very high'. Otherwise, low sounds will be muted.

Tip: The sensitivity level can be adjusted so you will always hear your baby without the disruption of other sounds. When there is a lot of background noise, turn the sensitivity lower so you will not hear these sounds through the parent unit.

- 3 Press the left part of the control button to save the new setting and to return to the main menu.

## Vibration

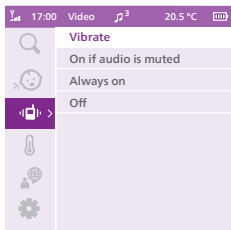

1 Press the right part of the control button to access the vibration options.

2 There are three options for vibration:

- 'On if audio is muted': When volume is set to minimum (muted) the parent unit will vibrate when sound is detected from the baby unit and above sensitivity level.
- 'Always on!': Parent unit will always vibrate when sound is detected from the baby unit and above sensitivity level.
- 'Off': Parent unit will never vibrate.

When vibration is on, the parent unit will vibrate when your baby cries or makes sounds, according to the sensitivity level you have selected. The parent unit also vibrates when the temperature alert is on and a maximum or minimum temperature is reached or when the parent unit lost connection with the baby unit.

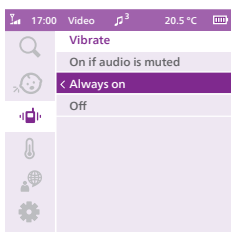

3 Press the left part of the control button to save the new setting and to return to the main menu.



## Temperature

The temperature sensor enables you to monitor the temperature in your baby's room.

Note: The current temperature in your baby's room is shown in the status bar of the parent unit.

1 Press the right part of the control button to access the temperature options.

Tip: You can change the temperature unit from C (Celsius) to F (Fahrenheit) by selecting the unit option.

Tip: Please do ensure the temperature sensor is not placed too close to any source that might impact its accuracy, e.g. heater, air-conditioning outlet, fan or window.

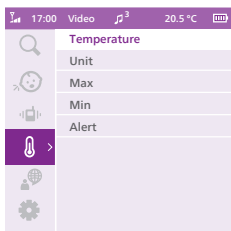

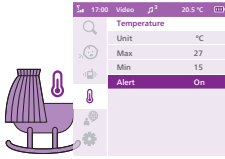

- In the temperature menu, an alert for temperature can be set on or off.

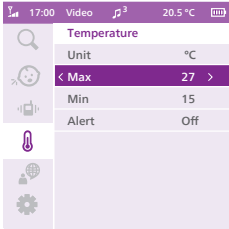

- You can select the alert option to turn on the alert. To change the maximum and minimum temperatures for the temperature alert, select the desired temperatures at 'Max' and 'Min' in the temperature menu.

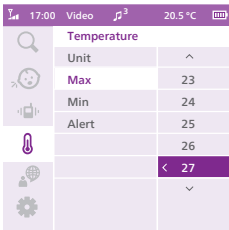

- Press the left part of the control button to save the new setting and to return to the main menu.

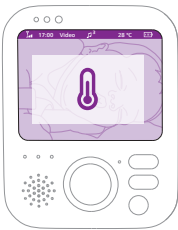

- The parent unit shows this alert when the chosen temperatures are measured or exceeded.

## Language

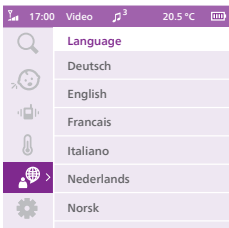

- Press the right part of the control button to access the list of languages.
- Press the top or bottom part of the control button to select the desired language.



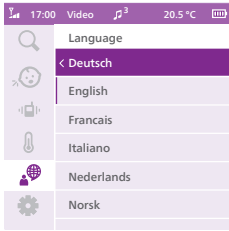

- 3 Press the left part of the control button to save the new setting and to return to the main menu.

## Setting

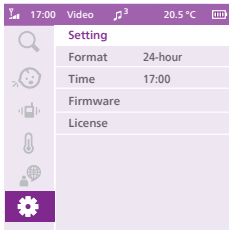

Press the right part of the control button to access the setting menu.

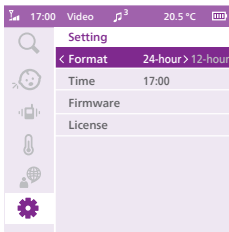

You can change the time format and time setting of your baby monitor.

- 1 Press the right part of the control button to enter the Time Format option.
- 2 Press the right part of the control button again to change the time format from 24-hour to 12-hour.

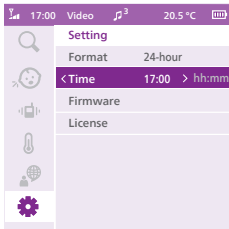

You can change the time by pressing the right part of the control button to enter the Time Setting option.

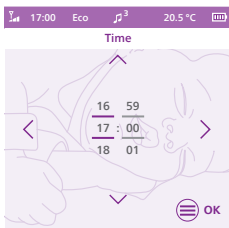

- 1 Press the left part of the control button to set hour and the right part of the control button to set minute. Press the top or bottom part of the control button to select the time.
- 2 Press the menu button to save the new time setting and to return to the main menu.

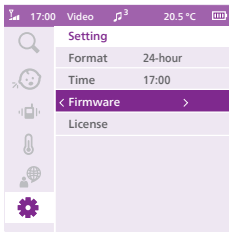

You can check the firmware version of the parent unit and baby unit.

- 1 Press the right part of the control button to access the Firmware Version option.

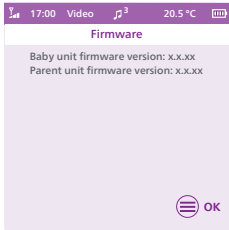

- 2 The display shows the firmware version of the parent unit and the baby unit.  
Your product's firmware is designed to be upgradeable for critical bug fixes. To get a better experience, check online regularly to see if any new version is available. To search for the latest firmware, please go to [www.philips.com/support](http://www.philips.com/support).

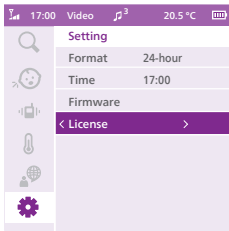

You can check the software license of your baby monitor.

- 1 Press the right part of the control button to enter the License option.

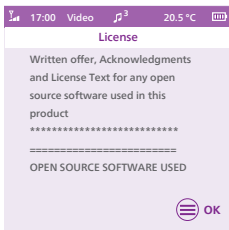

- 2 The display shows your baby monitor's license information.

## Belt clip

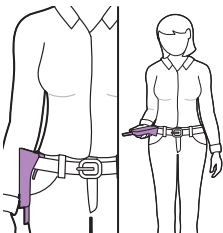

You can take the parent unit with you inside and outside the house by attaching the parent unit to your belt or waistband with the belt clip. This allows you to monitor your baby while you are moving around.

**Note:** The display is now turned upside down, which allows you to see your baby on the screen by simply lifting up the parent unit.

# Cleaning and maintenance

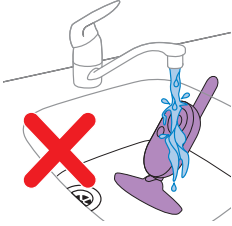

**Warning: Do not immerse the parent unit, baby unit and power adapters in water and do not clean them under the tap.**



**Warning: Do not use cleaning sprays or liquid cleaners.**

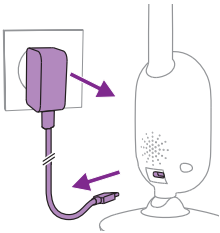

- 1 Switch off the baby unit, remove the power adapter from the baby unit and remove the power adapter from the wall socket.



- 2 Clean the baby unit with a dry cloth.

**Note: Fingerprints or dirt on the lens of the baby unit may affect the camera's performance. Avoid touching the lens with your fingers.**

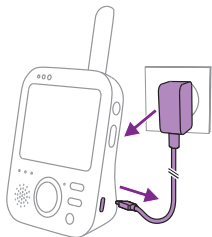

- 3 Switch off the parent unit, remove the power adapter from the parent unit and remove the power adapter from the wall socket.

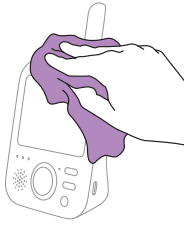

4 Clean the parent unit with a dry cloth.

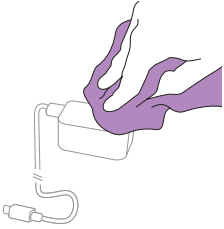

5 Clean the adapters with a dry cloth.

## Storage

When you are not going to use the baby monitor for a long time, store the parent unit, the baby unit and the adapters in a cool and dry place.

## Ordering accessories

To buy accessories or spare parts, visit [www.philips.com/parts-and-accessories](http://www.philips.com/parts-and-accessories) or go to your Philips dealer. You can also contact the Philips Consumer Care Center in your country (see the international warranty leaflet for contact details).

## Recycling



This symbol means that electrical products and batteries shall not be disposed of with normal household waste.

Follow your country's rules for the separate collection of electrical products and batteries.

## Environmental information

All unnecessary packaging has been omitted. We have tried to make the packaging easy to separate into two materials: cardboard (box) and polyethylene (bags, protective foam sheet).

## Removal of built-in rechargeable battery

The built-in rechargeable battery must only be removed by a qualified professional when the appliance is discarded. Before removing the battery, make sure that the appliance is disconnected from the wall socket and that the battery is completely empty.

Note: Take any necessary safety precautions when you handle tools to open the appliance and when you dispose of the rechargeable battery.

Note: When you handle batteries, make sure that your hands, the product and the batteries are dry.

Note: To avoid accidental short-circuiting of batteries after removal, do not let battery terminals come into contact with metal objects (e.g. coins, hairpins, rings). Do not wrap batteries in aluminum foil. Tape battery terminals or put batteries in a plastic bag before you discard them.

Procedure:

- 1 Remove the 2 rubber feet at the bottom of the parent unit.
- 2 Remove the 2 screws that are now visible at the bottom of the parent unit.
- 3 Remove the 2 screws next to the rating label, release the belt clip and slide open the battery compartment door.
- 4 Disconnect the battery connector cable (black-white-red cable).
- 5 Remove the battery.

If there is no collection/recycling system for electronic products in your country, you can protect the environment by removing and recycling the battery before disposing the product.

## Support

For all product support, please visit [www.philips.com/support](http://www.philips.com/support).

# Frequently asked questions

This chapter summarizes the most common problems you could encounter with the appliance. If you are unable to solve the problem with the information below, visit [www.philips.com/support](http://www.philips.com/support) for a list of frequently asked questions or contact the Consumer Care Center in your country.

## HOW TO USE / CONNECTING THE UNITS

Question	Answer
Why doesn't the power-on light of the baby unit turn on when I switch it on?	Perhaps the adapter is not plugged in properly. Connect the baby unit to the adapter and plug the adapter to the mains outlet. Then turn the on/off slide of the baby unit upwards to the ON position to establish a connection with the parent unit.
Why doesn't the parent unit charge when I plug it in?	Perhaps the adapter is not plugged in properly. Make sure the adapter is plugged into the wall socket properly.  The parent unit may already be fully charged. The battery status light will be green when the battery is fully charged and the device is connected to the mains power.
Why doesn't the baby unit charge when I plug it in?	The baby unit does not have a charging function, it only works when connected to the mains.
Why can't I establish a connection? Why is the connection lost every now and then? Why are there sound interference?	The baby unit and the parent unit are probably close to the outer limits of the operating range or there is interference from other 2.4 GHz wireless devices. Try a different location, decrease the distance between the units or switch off other 2.4 GHz wireless devices (laptops, mobile phones, microwaves, etc) . It can take up to 10 seconds before the connection between the units is reestablished.  If the signal is lost, the parent unit will make a beeping sound every 20 seconds.  The baby unit and parent unit might be too close to each other, keep them at least 2.5 meters/ 8.2 feet away from each other to prevent interference.
What happens during a power failure?	As the parent unit works on a rechargeable battery, the parent unit continues to work if the battery is sufficiently charged. However, the baby unit stops working because it has no rechargeable battery and only works on a mains power. The parent unit will give a beeping sound to indicate that the link with the baby unit is lost. You can temporarily connect the baby unit to a power bank during mains power failure. When mains power is restored, you can connect the baby unit to the mains.

## HOW TO USE / CONNECTING THE UNITS

---

Why can the charging time of the parent unit exceed 3 hours?

The parent unit may be switched on during charging. Switch off the parent unit during charging to reduce the charging time. When the display of the parent unit is constantly on, charging of the parent unit will take more time.

Perhaps temperature has exceeded the charging tolerance that could potentially cut off the charging circuit as a safety protection mechanism. To resume charging, move the charging station away from any heat sources such as radiators, heat registers, stove or other appliances (including amplifiers) that produce heat.

---

Why do I need to keep the baby unit and its cord at least 1 meter/ 3.5 feet away from my baby?

To avoid strangulation with the cord, always place the baby unit and its cord at least 1 meter / 3.5 feet away from the baby.

---

What is the difference between the various user modes on the parent unit: Video, Audio, Vox and Eco?

See below list for an explanation on the available modes on your baby monitor.

\* Video mode: the screen of the parent unit is always on. You will have continuous sound when the sensitivity level is set to 'very high'. Otherwise, low sounds will be muted.

---

\* Audio mode: only audio will be activated. The display of the parent unit switches off when Audio mode is activated. The link light shows that the parent unit is still on and connected to the baby unit. The sound level lights above the screen will light up green when sound from the baby unit is heard. All normal correspondence with the baby unit is possible via the talk back, soothing sound, menu and sensitivity buttons.

---

\* Vox mode: The display and sound of the parent unit switch off if there is no sound detected for 20 seconds (or not enough sound above the sensitivity setting). Both display and sound will be activated immediately when your baby cries and the sensitivity threshold is passed. When the sound drops below the sound threshold, the video will remain active for 20 seconds. When one of the control buttons is pressed (brightness or volume), the device shall display video for roughly 5 seconds. Also the soothing sound menu is accessible.

---

\* Eco mode: The display and sound of the parent unit switch off when no sound is detected for 20 seconds. Eco Mode reduces power consumption during quiet times while keeping you connected to your baby. In Eco mode the Eco LED light is green and the device will operate on a different connection modus. In Eco mode the parent unit uses the 2 seconds ping mechanism to check the connection with the baby unit instead of a continuous radio frequency connection. Therefore the Baby Unit will also consume less energy in Eco mode.

---

## HOW TO USE / CONNECTING THE UNITS

---

The parent unit does not respond, what should I do? You can reset the parent unit by simultaneously pressing the on/off button and the navigation down button for about 1 second. The parent unit will switch off. To turn the parent unit back on, press the on/off button one more time. Specific user information stored in the memory of the parent unit, such as time, user mode, brightness settings, volume, soothing sound selection, zoom selection, and vibration settings, will be retained.

---

## INDICATIONS ON THE PARENT UNIT

---

Question	Answer
The battery LED on the parent unit turns red. What should I do?	<p>The battery power is low. If you do not connect the parent unit to the mains power when the battery LED has turned red and starts to make a beeping sound, the unit will stop working after approximately 60 minutes.</p> <hr/> <p>Switch to lower brightness and/or volume to save battery consumption and connect the parent unit to the mains with the power adapter. (see chapter 'Preparing for use').</p> <hr/>
Why does the parent unit beep?	<p>Your baby monitor beeps in a certain way to tell you what the problem is.</p> <hr/> <p>1 beep: parent unit is switched off.</p> <hr/> <p>1 beep, every 10 seconds for the first 3 minutes, after that, every minute: parent unit is low in battery.</p> <hr/> <p>1 beep, every 20 seconds: connection between parent and baby unit is lost, link icon is shown on the parent unit's screen and the link connection button is red.</p> <hr/> <p>1 beep, every 30 seconds: temperature of the baby room is outside the range that is defined by the user, temperature icon is shown on parent unit's screen.</p> <hr/>
What does the battery LED colour (green, orange, red) or no burning LED mean for the status of my battery?	<p>When the parent unit is connected to the mains power the color of the battery light will show:</p> <ul style="list-style-type: none"><li>* Green: battery is full.</li><li>* Orange: battery is charging.</li></ul> <hr/> <p>When the parent unit is not connected to the mains power the color of the battery light will show:</p> <ul style="list-style-type: none"><li>* Red: battery is almost empty (&lt;10 %)</li><li>* No burning LED: parent unit is not connected to the mains.</li></ul> <hr/>



## NOISE/SOUND

Question	Answer
Why does the parent unit and/or baby unit produce a high-pitched noise?	The parent unit and baby unit may be too close to each other. Make sure the parent unit and the baby unit are at least 2.5 meters / 8.2 feet away from each other.
	The volume of the parent unit may be set too high. Decrease the volume of the parent unit.
	For causes of a beeping sound from the parent unit, see the FAQ "Why does the parent unit beep?"
How can I mute the sound?	Mute the device by pressing the bottom part of the control button. When the volume bar on the screen is completely empty, the volume is muted.
Why don't I hear a sound? Why can't I hear my baby cry? Why do I experience only partial sound transmission but not all?	The volume of the parent unit may be set too low or may be switched off. Press the top part on the control button to increase the volume level.
	Perhaps the parent unit is muted, unmute the device by pressing the top part of the control button and adjust the volume.
	The sensitivity is set too low, adjust the sensitivity in the parent unit's menu to a higher level.
Why does the parent unit react too quickly to other sounds than my baby makes?	The baby unit may be too far away from your baby. Make sure the baby unit is not further than 1.5 meters/ 5 feet away from your baby for optimal sound detection. Closer than 1 meter /3.5 feet increases strangulation hazard.
	The baby unit also picks up other sounds than those of your baby. Move the baby unit closer to the baby (but observe the minimum distance of 1 meter/ 3.5 feet).
Why does the parent unit make a buzzing sound?	The sensitivity level may be set too high. When your baby makes soft sounds, the sensitivity has to be higher. However, the louder your baby sounds, the lower the sensitivity level can be set. You can change the sensitivity of your baby monitor on the parent unit's menu.
	Interference may occur when the parent unit is out of range of the baby unit. Interference may also occur if there are too many walls or ceilings between the parent unit and the baby unit or when other 2.4 GHz wireless devices are switched on (e.g. microwave, Wi-Fi router).
Why does the parent unit make a buzzing sound?	Put the parent unit in a different place, closer to the baby unit, or switch off other wireless devices.
	If this answer does not help you, check the other FAQ on " Why does the parent unit and/or baby unit produce a high-pitched noise?"

---

## NOISE/SOUND

---

How long will the soothing sound be played by the baby unit?	Once you select a soothing sound, it will be continuously repeated for approximately 15 minutes. In case you want to play all lullabies that are available, select All lullabies.
How can I increase the volume of the soothing sound?	You can adjust the volume of the soothing sound on the parent unit, not on the baby unit. Press the soothing sound button on the parent unit to open the soothing sound menu and adjust the volume.

---

## OPERATING TIME / RANGE

---

Question	Answer
Why does my baby monitor manage a much smaller distance than specified in this user manual?	<p>The specified operating range of 300 meters /985 feet is only valid outdoors in open air and in the line of sight. Depending on the surroundings and other disturbing factors, the operating range may be smaller (see the table in chapter 'Positioning the baby monitor').</p> <p>Inside your house, the operating range is up to 50 meters/165 feet, which is also limited by the number and type of walls and/or ceilings between the parent unit and the baby unit.</p>
The operating time of the parent unit is supposed to be up to 12 hours. Why is the operating time of my parent unit shorter?	<p>The video brightness of the parent unit may be set too high, which causes the parent unit to consume a lot of energy. Decrease the brightness of the parent unit.</p> <p>The parent unit consumes a lot of energy when the video display is switched on continuously. Activate the Audio, Vox or Eco mode in the parent unit's menu to increase the operating time (see chapter 'Features', sections 'Audio mode', 'Vox mode' or 'Eco mode').</p> <p>The volume of the parent unit may be set too high, which causes the parent unit to consume a lot of energy. Decrease the volume of the parent unit.</p> <p>As any other rechargeable electronic device, the battery capacity decreases after a long period of usage.</p>

---

## VIDEO DISPLAY

---

Question	Answer
Why do I get interference on the parent unit? Why does the video display on the parent unit flicker?	<p>Interference may occur when the parent unit is out of range of the baby unit. Interference may also occur if there are too many walls or ceilings between the parent unit and the baby unit or when other 2.4 GHz wireless devices are switched on (e.g. microwave, Wi-Fi router).</p> <p>Perhaps you have more than 2 sets of baby monitors and interference may occur. Keep these 2 baby units away from each other, ideally in separate rooms.</p> <p>Put the parent unit in a different place, closer to the baby unit, or switch off other wireless devices.</p> <p>The rechargeable battery of the parent unit may need to be charged.</p>

---

## VIDEO DISPLAY

---

Why isn't there any image on the video display while the link light is green? The parent unit may be in the Audio, Vox or Eco mode. Press the mode button on the right side of the parent unit to switch modes (see section 'Modes').

---

Why isn't the image on the video display clear? The display brightness may be set too low. Increase the display brightness on the parent unit using the control button in the centre (see section 'Brightness').

---

Perhaps the lens of the baby unit is dirty. Clean the lens with a dry cloth.

---

The baby unit may be too far away from your baby. Make sure the baby unit is not further than 1.5 meters / 5 feet away from your baby for optimal video quality. Closer than 1 meter / 3.5 feet increases strangulation hazard.

---

## General information

Rechargeable Li-ion battery (2600 mAh)

Wi-Fi frequency band: IEEE 802.11 b/g/n 2.4 GHz.

Maximum radio-frequency power:  $\leq 20$  dBm

Supply unit:

Model: ASSA105x-050100

x = E (EU plug) / x = B (UK plug)

x = C (AU plug) / x = J (BR plug)

Input: 100-240 V~, 50/60 Hz, 0.35 A

Output: 5.0 V  $\equiv$  1.0 A, 5.0 W

Average active efficiency:  $>73.6\%$

No-load power consumption:  $< 0.10$  W

# Wall mount

Printing instructions:

Print this page in scale 100 % and use the template to accurately mark the position of the holes for the screws on the wall.

