

PHILIPS

CANbus

H4-LED / H7-LED

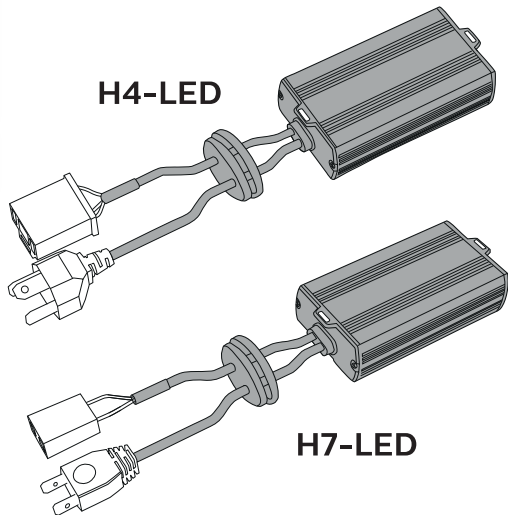

Option 1 (Gummi-Kappe) H4

1

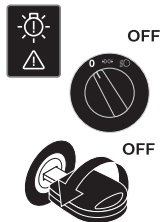

2a

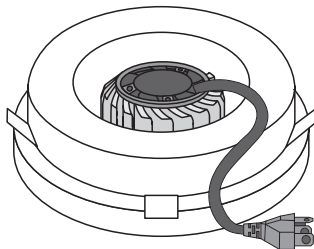

3a

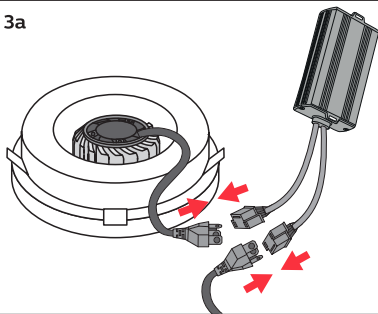

4a

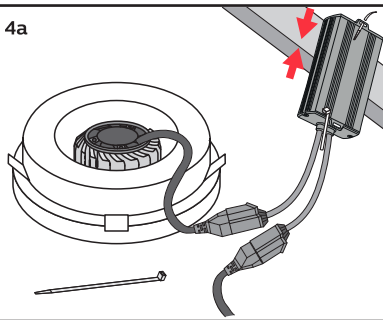

Option 2 (Deckel) H4/H7

1b

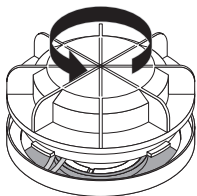

2b - Kunststoff-Deckel
Hard Cover

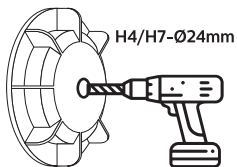

2C - Gummi-Kappe
Soft Cover

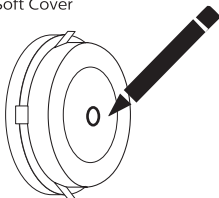

H4/H7-Ø23mm Kreis zeichnen
Draw 23mm circle

2C - Gummi-Kappe
Soft Cover

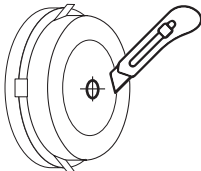

Gummi mit Messer innerhalb
des Kreises einschneiden
Make a cross with knife

2C - Gummi-Kappe
Soft Cover

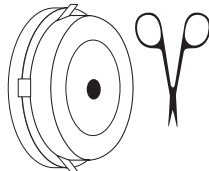

H4/H7-Ø23mm Kreis mit
Schere ausschneiden
Cut with nail scissors

Option 2 (Deckel) H4/H7

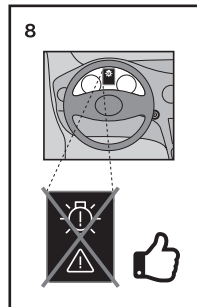
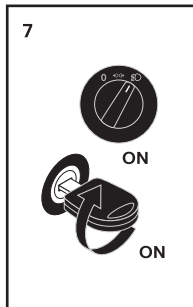
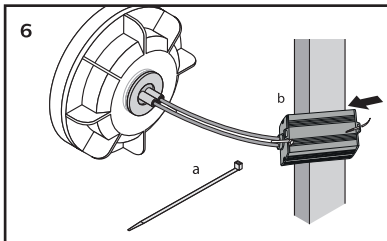
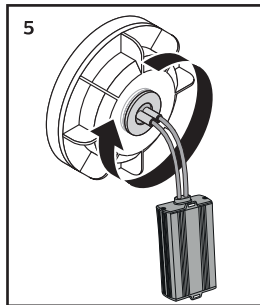
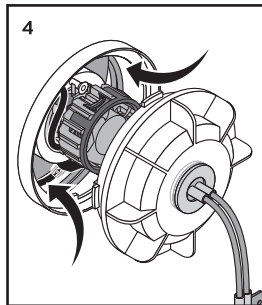
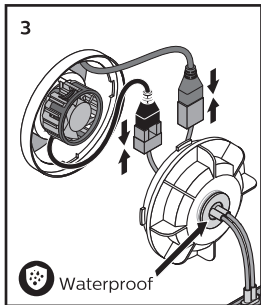

In der Regel muss der LED CANbus an einem festen Fahrzeugteil, bevorzugt aus Metall, außerhalb des Scheinwerfers befestigt werden.

Abhängig vom Scheinwerferdesign kann der CANbus auch im Scheinwerfergehäuse eingebaut und fixiert werden.

Bitte beachten Sie: Das Gehäuse des CANbus wird während des Betriebs der Scheinwerferlampe heiß.

Der CANbus darf nicht an beweglichen oder erhitzten Teilen des Autos befestigt werden. Stellen Sie sicher, dass alle Teile ausreichend befestigt sind und bewegliche Teile, sowie alle Fahrzeugfunktionen, weiterhin ordnungsgemäß funktionieren.

In general, LED CANbus must be attached to a fixed vehicle part, preferably made of metal, outside the headlamp.

Depending on the headlamp construction, the CANbus adapter may be installed and fixed within the headlamp.

Please note: The housing of the CANbus gets hot during the operation of the headlamp.

The CANbus must not be fixed to any moving or heated parts of the car. Make sure that all parts are fastened sufficiently and that moving parts, as well as all vehicle functions, continue to function properly.

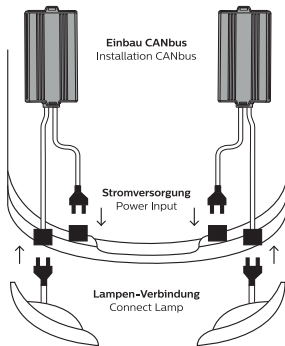

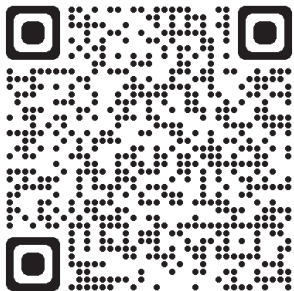

Bitte besuchen Sie
www.philips.com/roadlegalLED

Please visit
www.philips.com/roadlegalLED

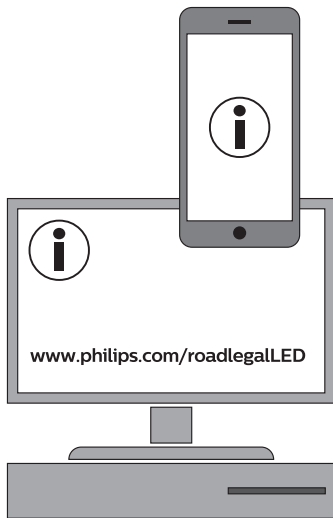



**Lumileds ist der Garantiegeber für dieses Produkt.
Philips und das Philips Wappen sind eingetragene Marken von
Koninklijke Philips N.V. und werden unter Lizenz verwendet.
©2023 Lumileds Holding B.V. Alle Rechte vorbehalten.**

Lumileds is the warrantor of this product.
Philips and the Philips Shield Emblem are registered trademarks of
Koninklijke Philips N.V. and are used under license.
© 2023 Lumileds Holding B.V. All rights reserved.