

RS232

RS232 Daisy Chain Cable



IR Sensor Cable

HDMI Cable

Dipole Antenna x2



SD card cover

M3

M2

* Differences according to regions.

Display design and accessories may differ from those illustrated above.

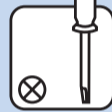

1

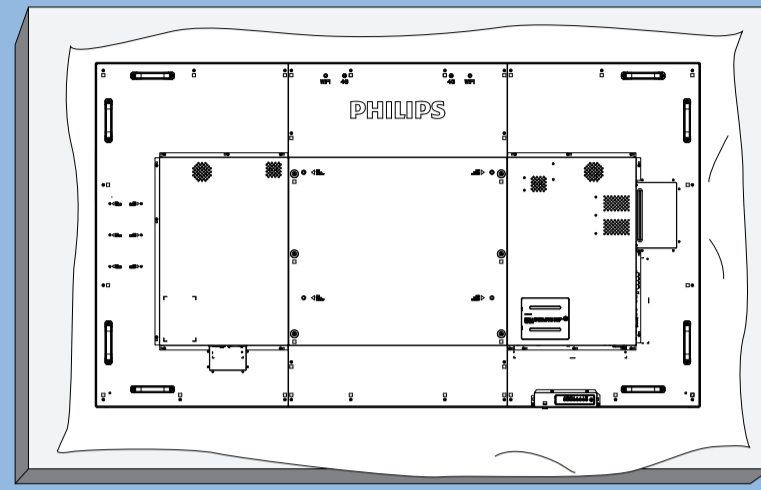

2

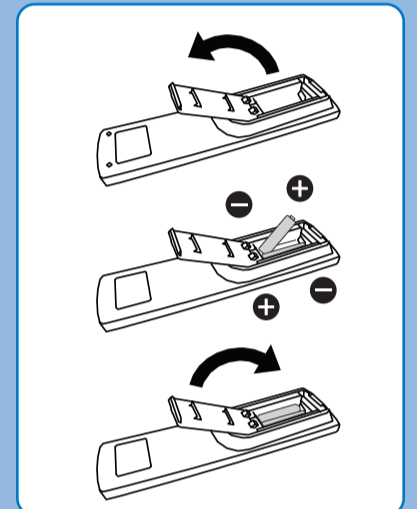
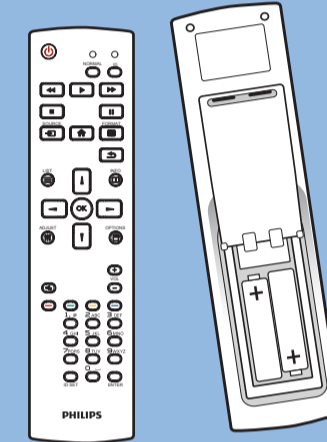
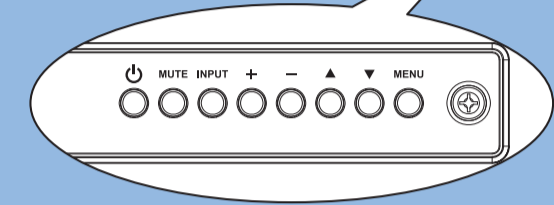
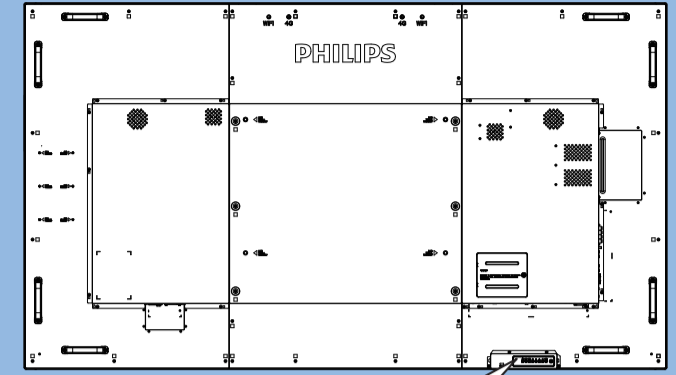

3

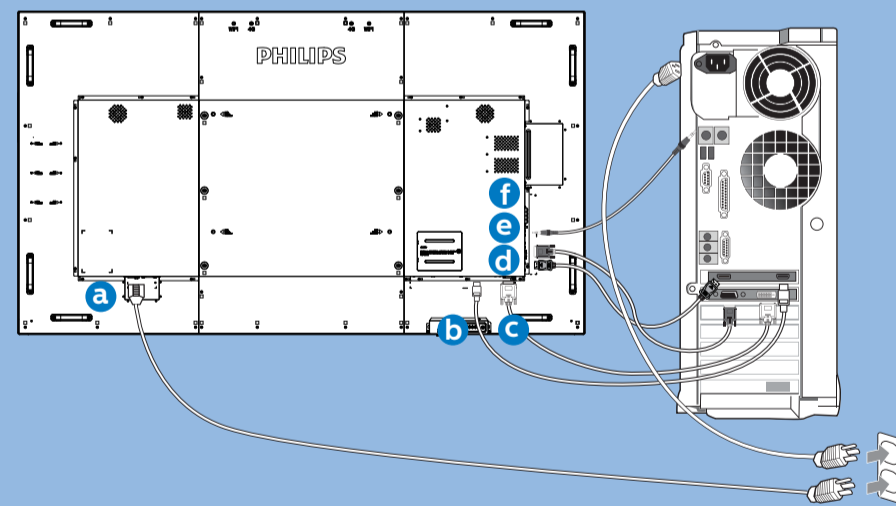
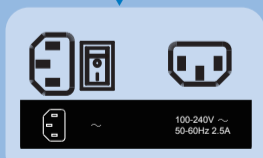
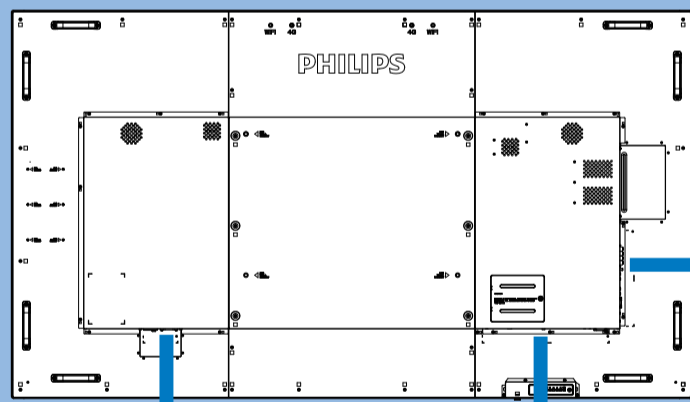

AC IN

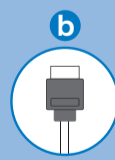

HDMI



DVI



DP

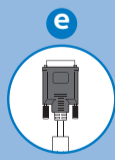

VGA



AUDIO

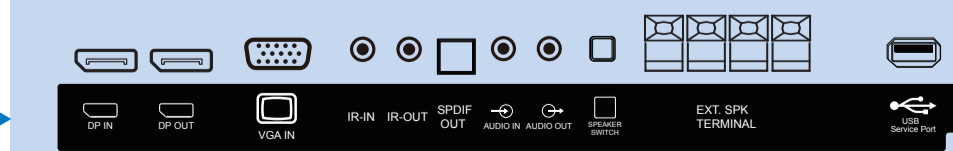

4

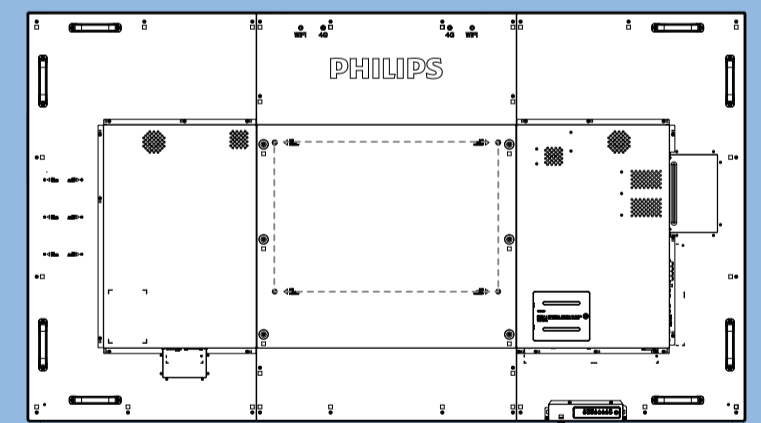

M8 * (15+X) mm
(X=Thickness of Wall mount BKT)

86BDL4150D: 600mmx400mm

5

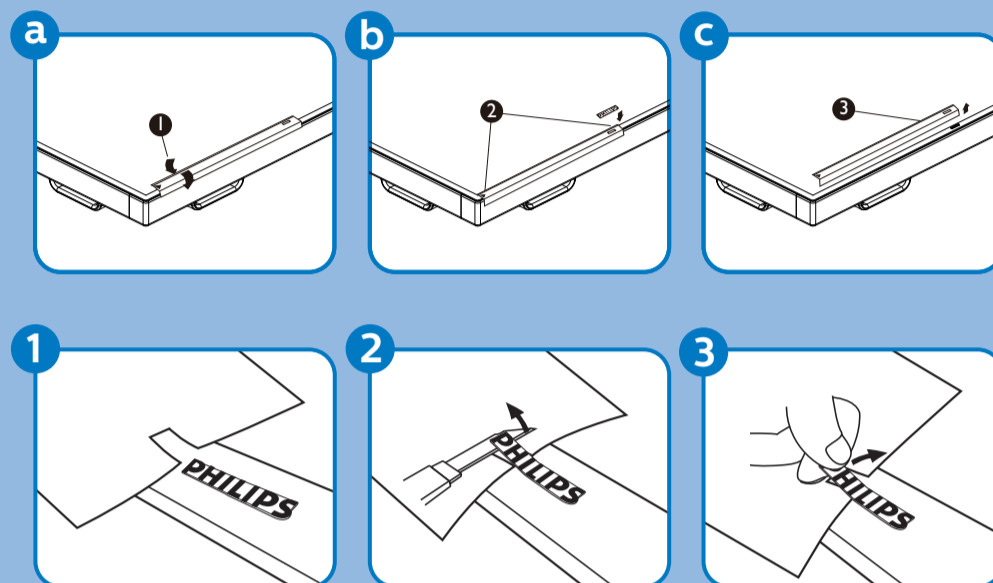
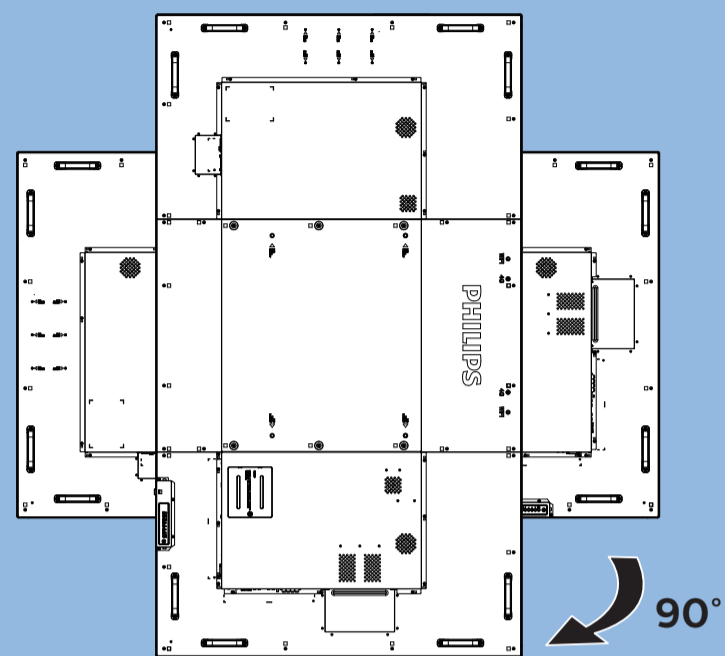

PHILIPS

D line

86BDL4150D



Quick Start



Please check out the website below for more product information.
www.philips.com/signagesolutions-support

6

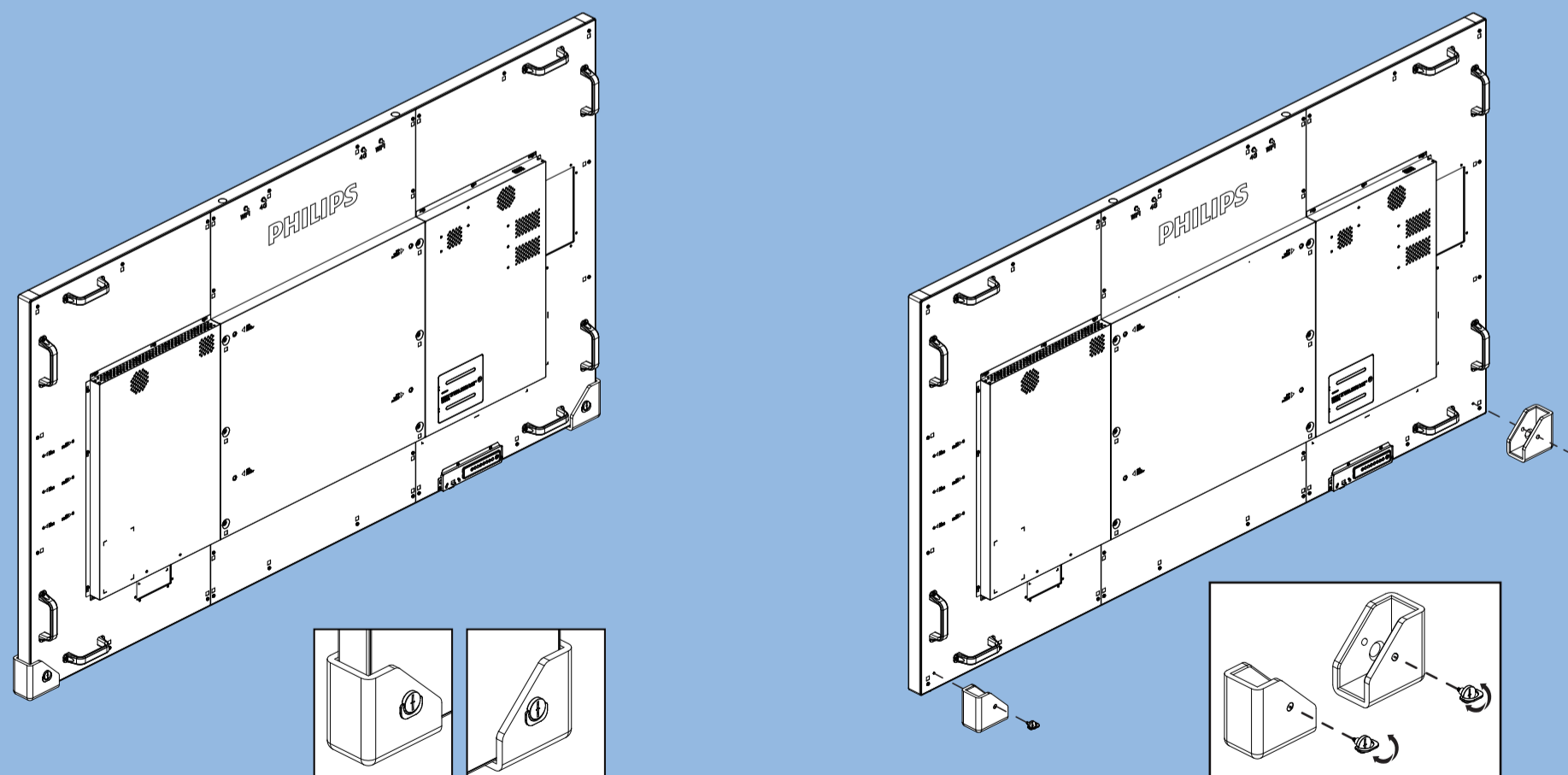

- Please always let the rubber corners on the display unless the display is on the wall.
- Please keep the rubber corners and the thumb screws properly and use them to protect the display when the display is not on the wall.



© 2018 Koninklijke Philips N.V. All rights reserved.

Philips and the Philips Shield Emblem are registered trademarks of Koninklijke Philips N.V. and are used under license from Koninklijke Philips N.V.

Specifications are subject to change without notice.

Version: V1.20 2018-08-09



Q41G86M181302B