

SAFETY AND  
TROUBLESHOOTING

ABOUT  
THIS MANUAL

PRODUCT  
INFORMATION

INSTALLING  
YOUR MONITOR

ON-SCREEN  
DISPLAY

TV CONTROL

CUSTOMER CARE  
AND WARRANTY

DOWNLOAD  
AND PRINT

EXIT 

**ELECTRONIC  
USER'S  
MANUAL**



**150T4**

**LCD MONITOR/TV**

# Safety and Troubleshooting Information

[Safety Precautions and Maintenance](#) • [Installation Locations](#) • [FAQs](#) • [Troubleshooting](#) • [Regulatory Information](#) • [Other Related Information](#)

---

## Safety precautions and maintenance



**WARNING: Use of controls, adjustments or procedures other than those specified in this documentation may result in exposure to shock, electrical hazards and/or mechanical hazards.**

Read and follow these instructions when connecting and using your computer monitor:

- Unplug the monitor if you are not going to use it for an extensive period of time.
- Unplug the monitor if you need to clean it with a slightly damp cloth. The screen may be wiped with a dry cloth when the power is off. However, never use alcohol, solvents or ammonia-based liquids.
- Consult a service technician if the monitor does not operate normally when you have followed the instructions in this manual.
- The casing cover should be opened only by qualified service personnel.
- Keep the monitor out of direct sunlight and away from stoves or any other heat source.
- Remove any object that could fall into the vents or prevent proper cooling of the monitor's electronics.
- Do not block the ventilation holes on the cabinet.
- Keep the monitor dry. To avoid electric shock, do not expose it to rain or excessive moisture.
- When positioning the monitor, make sure the power plug and outlet are easily accessible.
- If turning off the monitor by detaching the power cable or DC power cord, wait for 6 seconds before attach the power cable or DC power cord for normal operation.
- To avoid the risk of shock or permanent damage to the set, do not expose the monitor to rain or excessive moisture.
- **IMPORTANT:** Always activate a screen saver program during your application. If a still image in high contrast remains on the screen for an extended period of time, it may leave an 'after-image' or 'ghost image' on the front of the screen. This is a well-known phenomenon that is caused by the shortcomings inherent in the LCD technology. In most cases, the after-image will disappear gradually over a period of time after the power has been switched off. Be aware, that the after-image symptom cannot be repaired and is not covered under warranty.

Consult a service technician if the monitor does not operate normally when the operating instructions given in this manual have been followed.

[RETURN TO TOP OF THE PAGE](#)

---

## Installation Locations

- Avoid exposure to heat and extreme cold
- Do not store or use the product in locations exposed to heat, direct sunlight or extreme cold.
- Avoid moving the product between locations with large temperature differences. Choose a site that falls within the following temperature and humidity ranges.
  - Temperature: 5-40°C 41-104°F
  - Humidity: 20-80% RH
- Do not subject the product to severe vibration or high impact conditions. Do not place the product in the trunk of a car.
- Take care not to mishandle this product by either knocking or dropping it during operation or transportation.
- Do not store or use the product in locations where there is a high level of humidity or in dusty environments. Do not allow water or other liquids to spill on or into the product.

[RETURN TO TOP OF THE PAGE](#)

# About This Manual

[About This Guide](#) • [Notational Descriptions](#)

---

## About This Guide

This electronic user's guide is intended for anyone who uses the Philips LCD Monitor TV. It describes the features, setup, operation and other important information.

It includes the following sections:

- [Safety and Troubleshooting Information](#) provides tips and solutions for common problems as well as other related information you may need.
- About This Electronic User's Manual gives an overview of information included, along with notation icon descriptions and other documentation for your reference.
- [Product Information](#) gives an overview of the monitor's features as well as the technical specifications for this monitor.
- [Installing Your Monitor](#) describes the initial setup process and gives an overview of how to use the monitor.
- [On-Screen Display](#) provides information on adjusting the settings on your monitor.
- [TV Control](#) provides information on adjusting the settings for your TV function.
- [Customer Care and Warranty](#) contains a list of worldwide Philips Consumer Information Centres along with help desk phone numbers and information on the warranty applicable to your product.
- [Download and Print Option](#) transfers this entire manual to your hard drive for easy reference.

[RETURN TO TOP OF THE PAGE](#)

---

## Notational Descriptions

The following subsections describe notational conventions used in this document.

## Notes, Cautions and Warnings

Throughout this guide, blocks of text may be accompanied by an icon and printed in bold or italic type. These blocks contain notes, cautions or warnings. They are used as follows:



**NOTE:** This icon indicates important information and tips that help you make better use of your computer system.



**CAUTION:** This icon indicates information that tells you how to avoid either potential damage to hardware or loss of data.



**WARNING:** This icon indicates the potential for bodily harm and tells you how to avoid the problem.

Some warnings may appear in alternate formats and may not be accompanied by an icon. In such cases, the specific presentation of the warning is mandated by the relevant regulatory authority.

[RETURN TO TOP OF THE PAGE](#)

---

©2003 Koninklijke Philips Electronics N.V.

All rights reserved. Reproduction, copying, use, modification, hiring, renting, public performance, transmission and/or broadcasting in whole or in part is prohibited without written consent of Philips Electronics N.V.

# Product Information

[Product Features](#) • [Technical Specifications](#) • [Resolution & Preset Modes](#) • [Philips Pixel Defect Policy](#) • [Automatic Power Saving](#) • [Physical Specification](#) • [Pin Assignment](#) • [Product Views](#) • [Physical Function](#)

---

## Product Features

### 150T4

- 15-inch XGA LCD all-in-one Monitor TV with excellent display performance
- Multiple video input allowing display of PC, TV, HD (the US/Canada/Korea/Taiwan), VCD, DVD, Progressive DVD and CamCorder
- Digital High Definition Picture (1080i / 720P / 576P / 480P)
- D-Sub to YPbPr component Video input adapter cable for DVD & HD
- MultiSystem TV tuner-PAL/NTSC (available in most of the Asia Pacific area)

[RETURN TO TOP OF THE PAGE](#)

---

## Technical Specifications\*

### LCD PANEL

• Type	TFT LCD
• Screen size	15 inch
• Pixel Pitch	0.297 x 0.297mm
• LCD Panel type	1024 x 768 pixels R.G.B. vertical stripe Anti-glare polarizer
• Effective viewing area	(H) 304.1 x (V) 228.1mm
• Display Colors	8 bits interface (16.7M colors)

**PC SCANNING**

• Vertical refresh rate	56Hz-76Hz
• Horizontal frequency	30kHz-63kHz

**PC VIDEO**

• Video dot rate	80 MHz
• Input impedance	
- Video	75 ohm
- Sync	2K ohm
• Input signal levels	0.7 Vpp
• Sync input signal	Separate sync
• Sync polarities	Positive and negative
• Input Frequency	XGA Hsync 48- 63 kHz, Vsync 60 - 75 Hz (N.I.) SVGA Hsync 35- 50 kHz, Vsync 56 - 75 Hz (N.I.) VGA Hsync 31- 38 kHz, Vsync 60 - 75 Hz (N.I.)
• Video interface	D-sub, S-Video, TV-RF and composite video

**AUDIO**

• Input level for PC/SVHS	500 mV nominal
• Headphone out signal level	4mW max.
• Loudspeaker	2W Stereo Audio (1W/channel RMS x2, 200Hz~10kHz, 16 ohm, 10% THD)

**OPTICAL CHARACTERISTICS**

• Contrast ratio	350:1 (typ.)
• Brightness	250 cd/m <sup>2</sup> (typ.)

• Peak contrast angle	6 o'clock
• White Chromaticity	x: 0.283 y: 0.297 (at 9300° K) x: 0.313 y: 0.329 (at 6500° K) x: 0.313 y: 0.329 (sRGB)
• Viewing Angle (C/R $\geq 5$ )	Upper $\geq 50^\circ$ (typ.)  Lower $\geq 60^\circ$ (typ.)  Left $\geq 75^\circ$ (typ.)  Right $\geq 75^\circ$ (typ.)
• Response time	$\leq 25$ ms (typ.)

\* This data is subject to change without notice.

[RETURN TO TOP OF THE PAGE](#)

## Resolution & Preset Modes

- Maximum 1024 x 768 at 75Hz
- Recommended 1024 x 768 at 60Hz

### 14 user definable modes

### 11 factory preset modes:



Resolution	Mode	H. freq (kHz)	V. freq (Hz)
<b>PC</b>			
640*350	VGA-1	31.469	70.086
640*480	VGA VESA 60	31.469	59.940
640*480	Mac 13	35.000	66.667
640*480	VGA VESA 75	37.500	75.000
720*400	IBM VGA 3H	31.468	70.087
800*600	SVGA VESA 56	35.156	56.250
800*600	SVGA VESA 60	37.879	60.317
800*600	SVGA VESA 75	46.875	75.000
832*624	Mac 16	49.724	74.550
1024*768	XGA VESA 60	48.363	60.004
1024*768	XGA VESA 75	60.023	75.029

**Video**

Video	60Hz	15.734	59.940
Video	50Hz	15.625	50.000

**Progressive Video**

HD	480P	31.470	60.000
Pr. Component	576P	31.250	50.000
HD	1080i	33.750	60.000
HD	1080i	28.125	50.000
HD	720P	45.000	60.000
HD	720P	37.500	50.000

[RETURN TO TOP OF THE PAGE](#)

## Automatic Power Saving

If you have VESA DPMS compliance display card or software installed in your PC, the monitor can automatically reduce its power consumption when not in use. If an input from a keyboard, mouse or other input device is detected, the monitor will then 'wake up' automatically. The following table shows the power consumption and signaling of this automatic power saving feature:

Power Management Definition					
VESA Mode	Video	H-sync	V-sync	Power Used	LED color
ON	Active	Yes	Yes	25W (typ.)	Blue
OFF	Blanked	No	No	110VAC < 1W 230VAC < 2W	Amber

This monitor is ENERGY STAR® compliant. As an ENERGY STAR® Partner, PHILIPS has determined that this product meets the ENERGY STAR® guidelines for energy efficiency.

[RETURN TO TOP OF THE PAGE](#)

## Physical Specifications

• Dimension (WxHxD)	360 x 358 x 177 mm (incl. Pedestal)
• Weight	4.1 kg
• Tilt (Forward / Backward)	- 5° / 20°
• Power supply	100 — 240 VAC, 50/60 Hz
• Power consumption	25 W (typ.)
• Temperature (operating)	5° C to 40° C
• Relative humidity	20% to 80%

• System MTBF	50K hrs (excluding CCFL 40Khrs)
---------------	---------------------------------

\* This data is subject to change without notice.

[RETURN TO TOP OF THE PAGE](#)

## Pin Assignment

The 15-pin D-sub connector (male) of the signal cable:

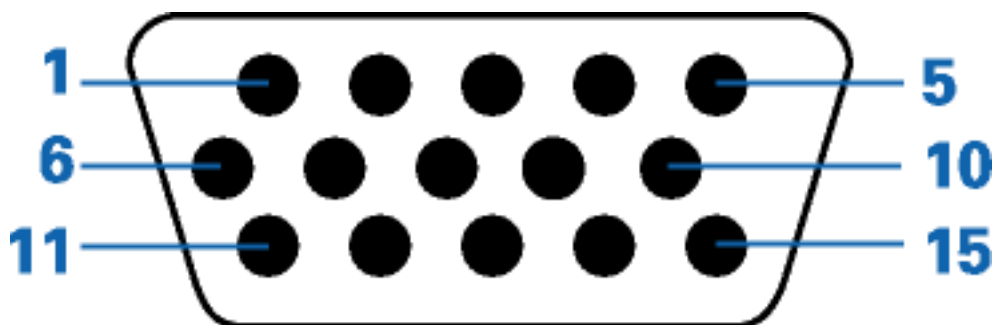

Pin No.	Assignment	Pin No.	Assignment
1	Red video input	9	DDC +5V
2	Green video input	10	Logic ground
3	Blue video input	11	Ground
4	Ground	12	Serial data line (SDA)
5	Ground	13	H. Sync
6	Red video ground	14	V. Sync
7	Green video ground	15	Data clock line (SCL)
8	Blue video ground		

[RETURN TO TOP OF THE PAGE](#)

---

## Product Views

Follow the links to see various views of the monitor and its components.

[Front View Product Description](#)

[RETURN TO TOP OF THE PAGE](#)

---

## Physical Function

### Tilt

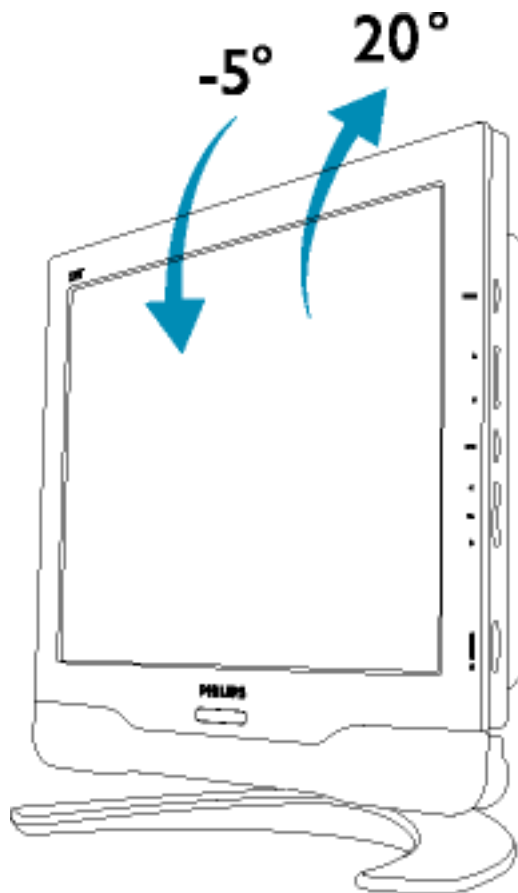

[RETURN TO TOP OF THE PAGE](#)

# Installing your LCD Monitor/TV



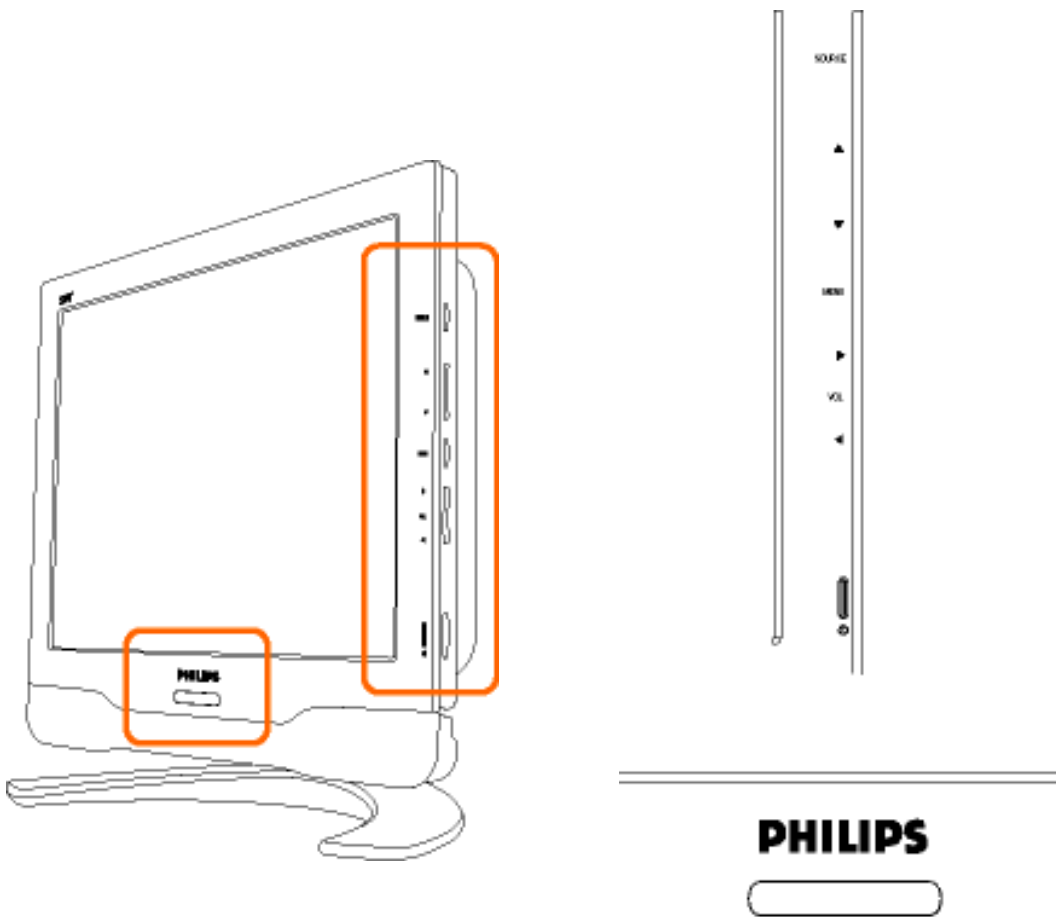

[Front View Product Description](#) • [Connecting to Your PC, TV antenna, DVD/VCR etc.](#) • [VESA Mounting and Easy Wall Mounting](#) • [Installing the Optional TV/AV Module](#) • [Getting Started](#) • [Optimising Performance](#)

---

## Front View Product Description



- 1 **SOURCE** TV/Video source selection

- 2  Increase or decrease the channel number  
or  
up or down the highlighted function in OSD
- 3 **MENU** Open the OSD and select the highlighted function
- 4  **VOL** Increase or decrease the level of audio volume  
or  
move up or down the highlighted function in OSD
- 5  Power indicator
- 6  Power switch On/Off
- 7  Receiver for 'remote control'

[RETURN TO TOP OF THE PAGE](#)

## Rear View

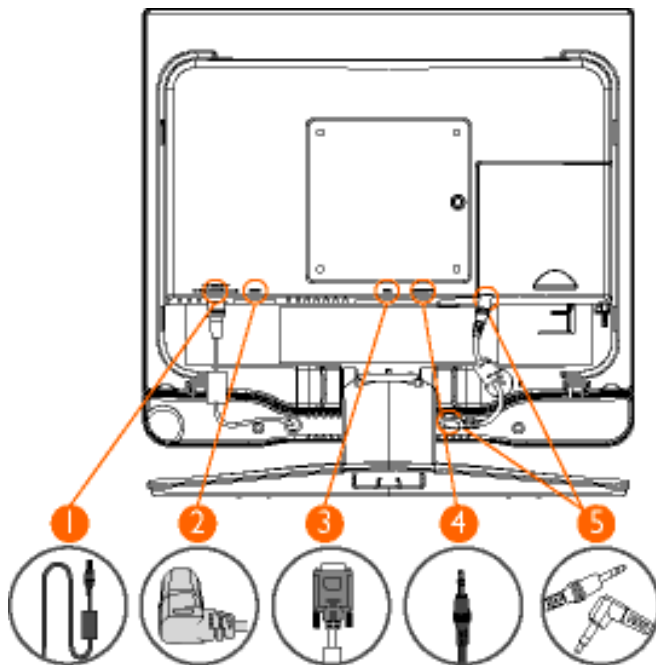

1	DC 12V out	For connect to "Audio Chin" only
2	AC in	AC power in
3	VGA	D-Sub input
4	PC - Audio in	For connect to PC Audio output
5	Audio out	For connect to Audio out

[RETURN TO TOP OF THE PAGE](#)

---

## Optimizing Performance

- For best performance, ensure that your display settings are set at 1024x768@60Hz (for 15").



**Note:** You can check the current display settings by pressing the 'MENU' button once.

- You can also install the [Flat Panel Adjust \(FP Adjust\) program](#), a program for getting the best performance out of your monitor. This is included on this CD. Step-by-step instructions are provided to guide you through the installation process. Click on the link to find out more about this program.

More about



[FP\\_setup03.exe](#)

[RETURN TO TOP OF THE PAGE](#)



# On-Screen Display

[Description of the On-Screen Display](#) • [The OSD Guide](#)

---

## Description of the On Screen Display

### *What is the On-Screen Display?*

This is a feature offered by all Philips LCD monitors/TVs. It allows an end user to adjust screen performance of monitors directly through an on-screen instruction window. The user interface provides user-friendliness and ease-of-use when operating the monitor.

### *Basic and simple instruction on the control keys*

When you press the **MENU** button on the front control of your monitor, the On-Screen Display (OSD) Main Controls window will pop up and you can then start making adjustments to the various monitor features.

Use the   or the   keys to make your adjustments.

[RETURN TO TOP OF THE PAGE](#)

---

## The OSD Guide

Below is an overall view of the structure of the On-Screen Display. You can use this as a reference when you want to work your way around the different adjustments later on.

There are three versions of OSD by region:

- [Europe](#)
  - [Asia Pacific and China](#) excluding Korea, Taiwan and Philippines
  - [Americas](#) and Korea, Taiwan and Philippines
-

## Europe OSD Guide

### PC Mode

<b>INPUT SELECT</b>		Select video source for main display:
	<b>PC</b>	<ul style="list-style-type: none"> <li>• PC VGA input</li> </ul>
	<b>TV</b>	<ul style="list-style-type: none"> <li>• Antenna or cable TV input</li> </ul>
	<b>AV</b>	<ul style="list-style-type: none"> <li>• CVBS Composite Video input</li> </ul>
	<b>S-VIDEO</b>	<ul style="list-style-type: none"> <li>• S-video input</li> </ul>
	<b>HD-YPbPr</b>	<ul style="list-style-type: none"> <li>• Progressive video input &amp; YPbPr component video input</li> </ul>
<b>LANGUAGE</b>		Set language for OSD
	<b>ENGLISH</b>	
	<b>DEUTSCH</b>	
	<b>FRANÇAIS</b>	
	<b>ITALIANO</b>	
	<b>ESPAÑOL</b>	
<b>ADJUST POSITION</b>		Adjust positions to get optimum display location on the screen
	<b>HORIZONTAL</b>	
	<b>VERTICAL</b>	
<b>BRIGHTNESS &amp; CONTRAST</b>		Adjust brightness and contrast to obtain optimum display
	<b>BRIGHTNESS</b>	
	<b>CONTRAST</b>	

<b>VIDEO NOISE</b>	Adjust phase and clock to obtain stable and clear display	
	<b>PHASE</b>	
	<b>CLOCK</b>	
<b>ADJUST COLOR</b>	Set color temperature to suit personal preference	
	<b>ORIGINAL PANEL COLOR</b>	
	<b>9300K FOR CAD/CAM</b>	
	<b>6500K FOR IMAGE MANAGEMENT</b>	
	<b>SRGB</b>	
	<b>USER PRESET</b>	RED GREEN BLUE
<b>RESET TO FACTORY SETTINGS</b>	Reset the setting to default values	
	<b>NO</b>	
	<b>YES</b>	
<b>AUTO</b>	Automatic adjustment of the display parameters to give optimum display	
<b>EXIT</b>	Exit from this menu	

[RETURN TO TOP OF THE PAGE](#)

### TV/Video/HD Mode

<b>INPUT SELECT</b>	Select video source for main display:	
	<b>PC</b>	<ul style="list-style-type: none"> <li>• PC VGA input</li> </ul>

<b>TV</b>	<ul style="list-style-type: none"> <li>• Antenna or cable TV input</li> </ul>
<b>AV</b>	<ul style="list-style-type: none"> <li>• CVBS Composite Video input</li> </ul>
<b>S-VIDEO</b>	<ul style="list-style-type: none"> <li>• S-video input</li> </ul>
<b>HD-YPbPr</b>	<ul style="list-style-type: none"> <li>• Progressive video input &amp; YPbPr component video input</li> </ul>
<b>PICTURE</b>	Adjust picture characteristics to suit personal preference
<b>BRIGHTNESS</b>	
<b>CONTRAST</b>	
<b>COLOR</b>	
<b>SHARPNESS</b>	
<b>COLOR TEMP</b>	<ul style="list-style-type: none"> <li>• Normal</li> <li>• Cool</li> <li>• Warm</li> </ul>
<b>EXIT</b>	
<b>SOUND</b>	Adjust audio characteristics to suit personal preference
<b>TREBLE</b>	
<b>BASS</b>	
<b>BALANCE</b>	
<b>SURROUND (ON/OFF)</b>	
<b>EXIT</b>	
<b>LANGUAGE</b>	Set language for OSD
<b>ENGLISH</b>	
<b>DEUTSCH</b>	
<b>FRANÇAIS</b>	

	<b>ITALIANO</b>	
	<b>ESPAÑOL</b>	
<b>INSTALL</b>		Install a TV program list
	<b>SYSTEM</b>	Specify the TV system at the user location: <ul style="list-style-type: none"> <li>● WEST EUR</li> <li>● FRANCE</li> </ul>
	<b>AUTO STORE</b>	Scan and store the TV programs at the user location automatically
	<b>MANUAL STORE</b>	<ul style="list-style-type: none"> <li>● Search</li> <li>● Prog. No</li> <li>● Fine tune</li> <li>● Store</li> <li>● Exit</li> </ul> <p>Fine tune and store the TV programmes at the user location manually</p>
	<b>CHANNEL SKIP</b>	Set the skipped programme when accessing programmes using the  keys
	<b>CHANNEL SWAP</b>	
	<b>EXIT</b>	
<b>VIDEO MODE</b>		
	<b>REGULAR</b>	When viewing regular 4:3 format video signal
	<b>WIDE</b>	When viewing wide (16:9) format video signal, e.g. HD
<b>EXIT</b>		Exit from this menu

[RETURN TO TOP OF THE PAGE](#)

## Asia Pacific and China OSD Guide (excluding Korean, Taiwan and Philippines)

### PC Mode

<b>INPUT SELECT</b>	Select video source for main display:
<b>PC</b>	<ul style="list-style-type: none"> <li>• PC VGA input</li> </ul>
<b>TV</b>	<ul style="list-style-type: none"> <li>• Antenna or cable TV input</li> </ul>
<b>AV</b>	<ul style="list-style-type: none"> <li>• CVBS Composite Video input</li> </ul>
<b>S-VIDEO</b>	<ul style="list-style-type: none"> <li>• S-video input</li> </ul>
<b>HD-YPbPr</b>	<ul style="list-style-type: none"> <li>• Progressive video input &amp; YPbPr component video input</li> </ul>
<b>LANGUAGE</b>	Set language of OSD
<b>ENGLISH</b>	
<b>中文</b>	
<b>ADJUST POSITION</b>	Adjust positions to obtain optimum display location on the screen
<b>HORIZONTAL</b>	
<b>VERTICAL</b>	
<b>BRIGHTNESS &amp; CONTRAST</b>	Adjust brightness and contrast to obtain optimum display
<b>BRIGHTNESS</b>	
<b>CONTRAST</b>	
<b>VIDEO NOISE</b>	Adjust phase and clock to obtain stable and clear display
<b>PHASE</b>	
<b>CLOCK</b>	

<b>ADJUST COLOR</b>	Set color temperature to suit personal preference	
	<b>ORIGINAL PANEL COLOR</b>	
	<b>9300K FOR CAD/CAM</b>	
	<b>6500K FOR IMAGE MANAGEMENT</b>	
	<b>sRGB</b>	
	<b>USER PRESET</b>	RED GREEN BLUE
<b>RESET TO FACTORY SETTINGS</b>	Reset the setting to default values	
	<b>NO</b>	
	<b>YES</b>	
<b>AUTO</b>	Automatic adjustment of the display parameters to give optimum display	
<b>EXIT</b>	Exit from this menu	

[RETURN TO TOP OF THE PAGE](#)

---

### TV/Video/HD Mode

<b>INPUT SELECT</b>	Select video source for main display:	
	<b>PC</b>	<ul style="list-style-type: none"> <li>● PC VGA input</li> </ul>
	<b>TV</b>	<ul style="list-style-type: none"> <li>● Antenna or cable TV input</li> </ul>
	<b>AV</b>	<ul style="list-style-type: none"> <li>● CVBS Composite Video input</li> </ul>

<b>S-VIDEO</b>	<ul style="list-style-type: none"> <li>• S-video input</li> </ul>
<b>HD-YPbPr</b>	<ul style="list-style-type: none"> <li>• Progressive video input &amp; YPbPr component video input</li> </ul>
<b>PICTURE</b>	Adjust picture characteristics to suit personal preference
<b>BRIGHTNESS</b>	
<b>CONTRAST</b>	
<b>COLOR</b>	
<b>SHARPNESS</b>	
<b>TINT</b>	
<b>COLOR TEMP</b>	<ul style="list-style-type: none"> <li>• Normal</li> <li>• Cool</li> <li>• Warm</li> </ul>
<b>EXIT</b>	
<b>SOUND</b>	Adjust audio characteristics to suit personal preference
<b>TREBLE</b>	
<b>BASS</b>	
<b>BALANCE</b>	
<b>SURROUND (ON/OFF)</b>	
<b>EXIT</b>	
<b>LANGUAGE</b>	Set language for OSD
<b>ENGLISH</b>	
<b>中文</b>	
<b>INSTALL</b>	Install a TV program list
<b>AUTO STORE</b>	Scan and store the TV programs at the user location automatically



<b>MANUAL STORE</b>	Fine tune and store the TV programs at the user location manually
<b>CHANNEL SKIP</b>	Set the skipped programme when accessing programmes using the  keys
<b>CHANNEL SWAP</b>	
<b>EXIT</b>	
<b>VIDEO MODE</b>	
<b>REGULAR</b>	When viewing regular 4:3 format video signal
<b>WIDE</b>	When viewing wide (16:9) format video signal, e.g. HD
<b>EXIT</b>	Exit from this menu

[RETURN TO TOP OF THE PAGE](#)

## Americas OSD Guide (including Korean, Taiwan and Philippines)

### PC Mode

<b>INPUT SELECT</b>	Select video source for main display:
<b>PC</b>	<ul style="list-style-type: none"> <li>● PC VGA input</li> </ul>
<b>TV</b>	<ul style="list-style-type: none"> <li>● Antenna or cable TV input</li> </ul>
<b>AV</b>	<ul style="list-style-type: none"> <li>● CVBS composite video input</li> </ul>
<b>S-VIDEO</b>	<ul style="list-style-type: none"> <li>● S-video input</li> </ul>

	<b>HD-YPbPr</b>	<ul style="list-style-type: none"> <li>Progressive video input &amp; YPbPr component video input</li> </ul>
<b>LANGUAGE</b>		Set language for OSD
	<b>ENGLISH</b>	
	<b>ESPAÑOL</b>	
	<b>FRANÇAIS</b>	
	中文	
<b>ADJUST POSITION</b>		Adjust positions to obtain optimum display location on the screen
	<b>HORIZONTAL</b>	
	<b>VERTICAL</b>	
<b>BRIGHTNESS &amp; CONTRAST</b>		Adjust brightness and contrast to obtain optimum display
	<b>BRIGHTNESS</b>	
	<b>CONTRAST</b>	
<b>VIDEO NOISE</b>		Adjust phase and clock to obtain stable and clear display
	<b>PHASE</b>	
	<b>CLOCK</b>	
<b>ADJUST COLOR</b>		Set color temperature to suit personal preference
	<b>ORIGINAL PANEL COLOR</b>	
	<b>9300K FOR CAD/CAM</b>	
	<b>6500K FOR IMAGE MANAGEMENT</b>	
	<b>sRGB</b>	
	<b>USER PRESET</b>	RED GREEN BLUE
<b>RESET</b>		Reset the setting to default values

NO

YES

**AUTO**

Automatic adjustment of the display parameters to give optimum display

**EXIT**

Exit from this menu

[RETURN TO TOP OF THE PAGE](#)**TV/Video/HD Mode****INPUT SELECT**

Select video source for main display:

**PC**

- PC VGA input

**TV**

- Antenna or cable TV input

**AV**

- CVBS composite video input

**S-VIDEO**

- S-video input

**HD-YPbPr**

- Progressive video input & YPbPr component video input

**PICTURE**

Adjust picture characteristics to suit personal preference

**BRIGHTNESS****CONTRAST****COLOR****SHARPNESS****TINT**

<b>COLOR TEMP</b>	<ul style="list-style-type: none"> <li>• Normal</li> <li>• Cool</li> <li>• Warm</li> </ul>
<b>EXIT</b>	
<b>SOUND</b>	Adjust audio characteristics to suit personal preference
<b>TREBLE</b>	
<b>BASS</b>	
<b>BALANCE</b>	
<b>SURROUND (ON/OFF)</b>	
<b>EXIT</b>	
<b>LANGUAGE</b>	Set language for OSD
<b>ENGLISH</b>	
<b>ESPAÑOL</b>	
<b>FRANÇAIS</b>	
<b>中文</b>	
<b>INSTALL</b>	Install a TV program list
<b>TUNER MODE</b>	Set the tuner mode: <ul style="list-style-type: none"> <li>• auto</li> <li>• antenna</li> <li>• cable</li> </ul>
<b>AUTO STORE</b>	Scan and store the TV programs at the user location automatically
<b>FINETUNE</b>	Fine tune and store the TV programs at the user location manually
<b>CHANNEL EDIT</b>	Set the skipped channel when accessing channel by 
<b>EXIT</b>	

<b>VIDEO MODE</b>	
<b>REGULAR</b>	When viewing regular 4:3 format video signal
<b>WIDE</b>	When viewing wide (16:9) format video signal, e.g. HD
<b>EXIT</b>	Exit from this menu

[RETURN TO TOP OF THE PAGE](#)

# TV Control

## [Using Your Remote Control](#)

### Using Other Menu:

- [Europe area](#)
  - [Asia Pacific area and China excluding Korea, Taiwan and Philippines](#)
  - [Americas, Korea, Taiwan and Philippines](#)
- 

## Using Your Remote Control

[For European countries](#)

[For countries outside Europe](#)

---

### For European countries

Remote Control Diagram

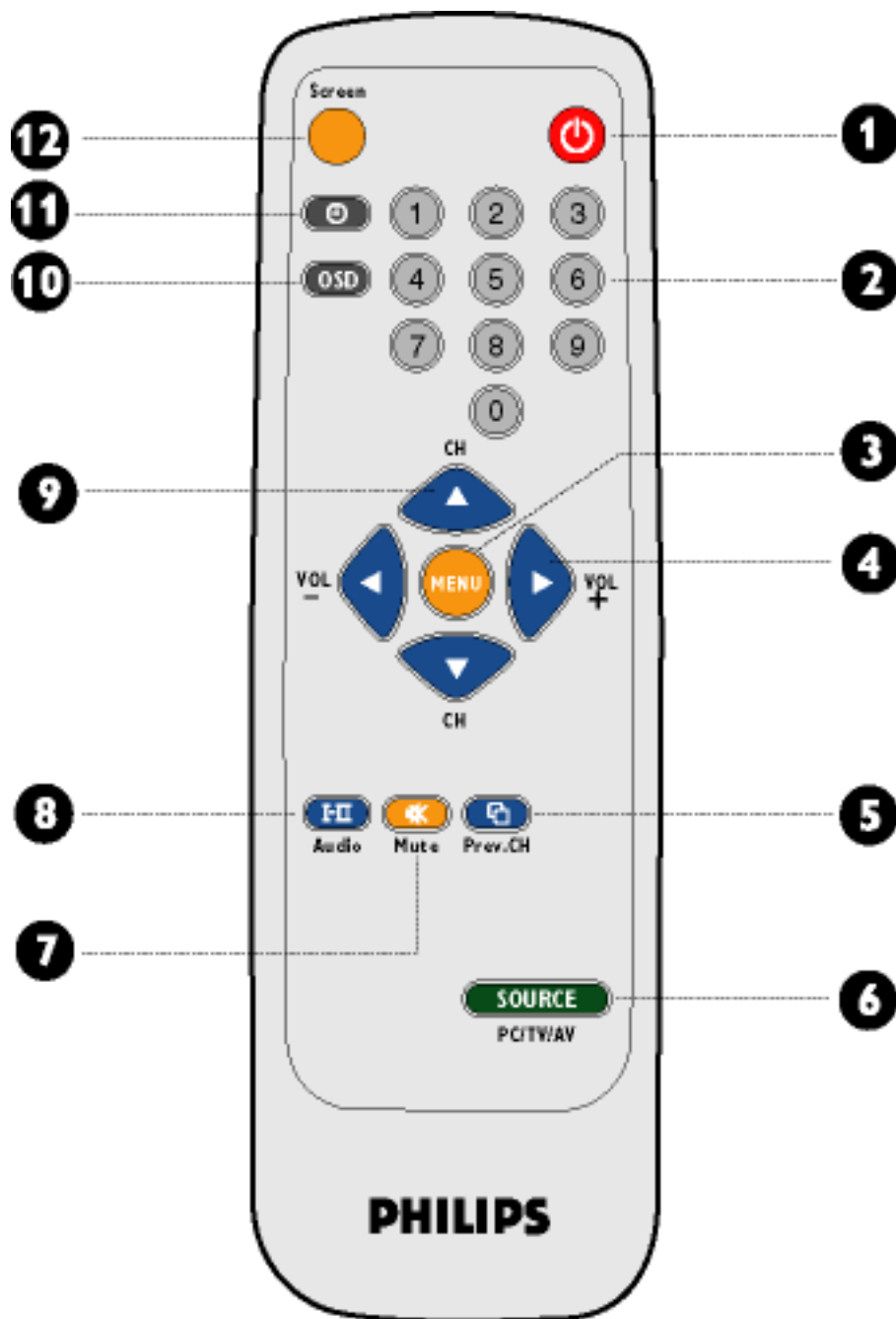

1	<b>Standby</b>	To set the TV temporarily to standby mode. To switch on the TV set, press Programme button (CH -, +), any digit between 0 and 9 or AV source button (The amber light indicates when set is in standby mode)
2	<b>Numerical keys</b>	<ul style="list-style-type: none"> <li>• For direct access to programmes For a 2-digit programme number, the 2nd digit must be entered before the dash disappears.</li> <li>• In PC/Video 'STANDBY' mode, press any of number keys to return to 'ON' in TV mode.</li> </ul>

3	<b>Menu</b>	<ul style="list-style-type: none"> <li>• To turn on or off the OSD (On-Screen Display)</li> <li>• To return to last item in OSD &amp; clear menu from screen</li> </ul>
4	<b>Volume</b>	<ul style="list-style-type: none"> <li>• To adjust the sound level.</li> <li>• To access the sub-menus and adjust the settings.</li> </ul>
5	<b>Previous programme</b>	To access the last programme viewed.
6	<b>SOURCE</b>	<ul style="list-style-type: none"> <li>• To select PC, TV, AV, S-Video and HD mode.</li> <li>• In PC 'standby' mode, press SOURCE to switch to TV mode.</li> </ul>
7	<b>Mute</b>	<ul style="list-style-type: none"> <li>• To disable sound.</li> <li>• To restore sound, press button again.</li> </ul>
8	<b>Audio Mode</b>	<ul style="list-style-type: none"> <li>• To switch from STEREO to MONO or to choose between Dual I and Dual II for bilingual transmissions.</li> <li>• For TV sets fitted with NICAM reception, depending on the transmission, you can switch from NICAM STEREO to MONO or choose between NICAM DUAL I, NICAM DUAL II and MONO.</li> </ul>
9	<b>Selecting TV programmes</b>	<ul style="list-style-type: none"> <li>• To move up or down a programme.</li> <li>• To move the cursor up/down to scroll through a list of options.</li> <li>• In PC/Video 'Standby' mode, press CH+/- to return to 'on' in TV mode.</li> </ul>
10	<b>OSD</b>	To show OSD status.
11	<b>Sleep timer</b>	To select the period of time after which the set will switch automatically to standby mode (up to 240 minutes)



12	Screen mode
----	-------------

To switch between 4:3 and 16:9 video format for optimum viewing ratio.
--

[RETURN TO TOP OF THE PAGE](#)

## For countries outside Europe

### Remote Control Diagram

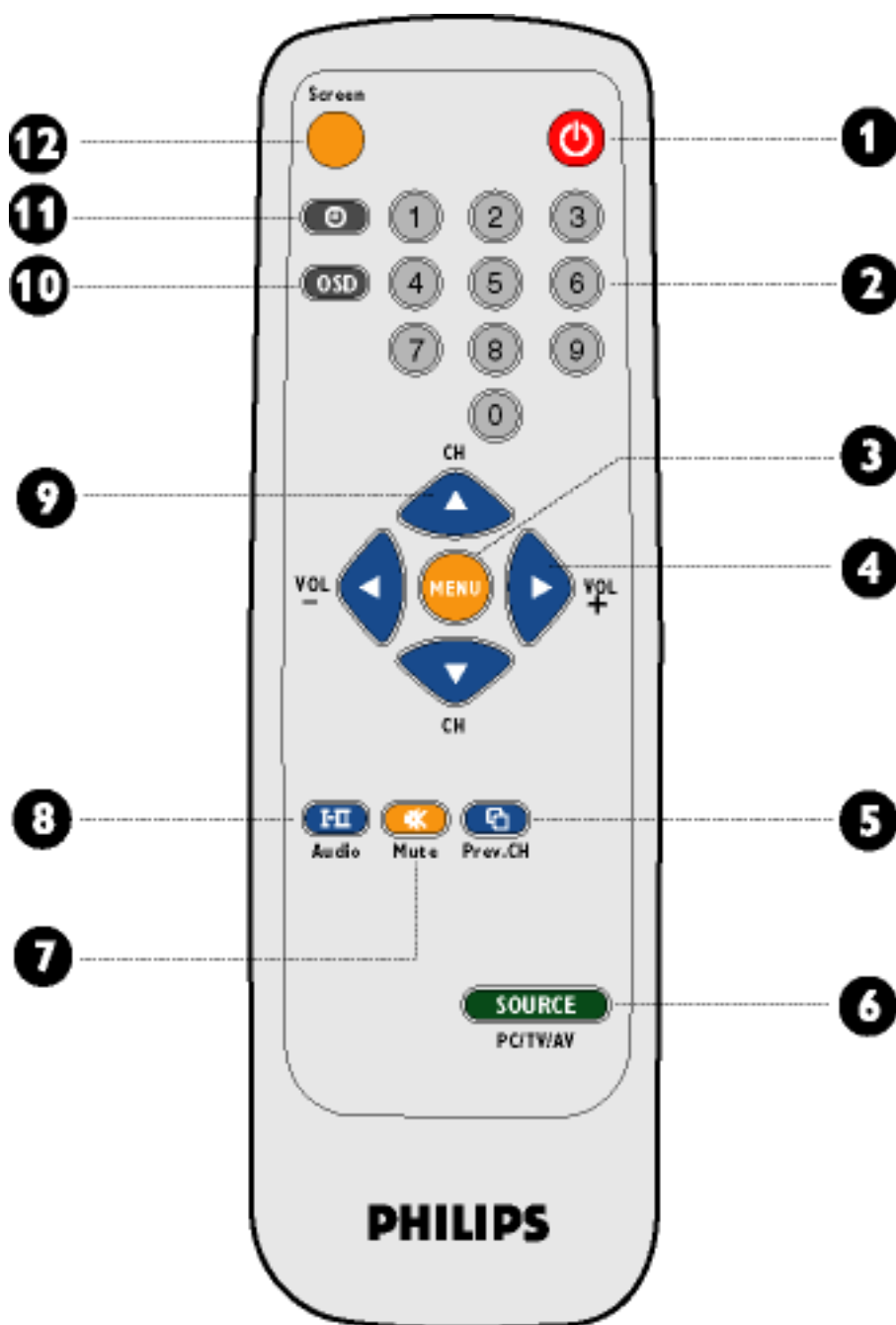

1	<b>Standby</b>	To set the TV temporarily to standby mode. To switch on the TV set, press Standby button, Programme button (CH -, +), any digit between 0 and 9 or AV source button. (The amber light indicates when set is in standby mode)
2	<b>Numerical keys</b>	<ul style="list-style-type: none"> <li>• For direct access to programmes For a 2-digit programme number, the 2nd digit must be entered before the dash disappears.</li> <li>• In PC/Video 'STANDBY' mode, press any of number keys to return to 'ON' in TV mode.</li> </ul>
3	<b>Menu</b>	<ul style="list-style-type: none"> <li>• To turn on or off the OSD (On-Screen Display)</li> <li>• To return to last item in OSD and clear menu from screen</li> </ul>
4	<b>Volume</b>	<ul style="list-style-type: none"> <li>• To adjust the sound level.</li> <li>• To access the sub-menus and adjust the settings.</li> </ul>
5	<b>Previous programme</b>	To access the last programme viewed.
6	<b>SOURCE</b>	<ul style="list-style-type: none"> <li>• To select PC, TV, AV, S-Video and HD mode.</li> <li>• In PC 'standby' mode, press SOURCE to switch to TV mode.</li> </ul>
7	<b>Mute</b>	<ul style="list-style-type: none"> <li>• To disable sound.</li> <li>• To restore sound, press button again.</li> </ul>
8	<b>Audio Mode</b>	<ul style="list-style-type: none"> <li>• To switch from STEREO to MONO or to choose between Dual I and Dual II for bilingual transmissions.</li> <li>• For TV sets fitted with NICAM reception, depending on the transmission, you can switch from NICAM STEREO to MONO or choose between NICAM DUAL I, NICAM DUAL II and MONO.</li> </ul>

9	<b>Selecting TV programmes</b>	<ul style="list-style-type: none"><li>• To move up or down a programme.</li><li>• To move the cursor up/down to scroll through a list of options.</li><li>• In PC/Video 'Standby' mode, press CH+/- to return to 'on' in TV mode.</li></ul>
10	<b>OSD</b>	To show OSD status.
11	<b>Sleep timer</b>	To select the period of time after which the set will switch automatically to standby mode (up to 240 minutes)
12	<b>Screen mode</b>	To switch between 4:3 and 16:9 video format for optimum viewing ratio.

[RETURN TO TOP OF THE PAGE](#)

# Customer Care & Warranty

PLEASE SELECT YOUR COUNTRY/AREA TO REVIEW DETAILS OF YOUR WARRANTY COVERAGE

**WESTERN EUROPE:** [Austria](#) • [Belgium](#) • [Cyprus](#) • [Denmark](#) • [France](#) • [Germany](#) • [Greece](#) • [Finland](#) • [Ireland](#) • [Italy](#) • [Luxembourg](#) • [the Netherlands](#) • [Norway](#) • [Portugal](#) • [Sweden](#) • [Switzerland](#) • [Spain](#) • [United Kingdom](#)

**EASTERN EUROPE:** [Czech Republic](#) • [Hungary](#) • [Poland](#) • [Russia](#) • [Turkey](#)

**LATIN AMERICA:** [Antilles](#) • [Argentina](#) • [Brasil](#) • [Chile](#) • [Colombia](#) • [Mexico](#) • [Paraguay](#) • [Peru](#) • [Uruguay](#) • [Venezuela](#)

**NORTH AMERICA:** [Canada](#) • [USA](#)

**PACIFIC:** [Australia](#) • [New Zealand](#)

**ASIA:** [Bangladesh](#) • [China](#) • [Hong Kong](#) • [India](#) • [Indonesia](#) • [Japan](#) • [Korea](#) • [Malaysia](#) • [Pakistan](#) • [Philippines](#) • [Singapore](#) • [Taiwan](#) • [Thailand](#)

**AFRICA:** [Morocco](#) • [South Africa](#)

**MIDDLE EAST:** [Dubai](#) • [Egypt](#)

---

# Download and Print

[Installing your LCD monitor driver](#) • [Download and Printing Instructions](#) • [Installing FPadjust Program](#)

---

## Installing Your LCD monitor driver

*System requirements:*

- PC running Windows® 95, Windows® 98, Windows® 2000 , Windows® Me, Windows® XP or later
- Find your driver ".inf/.icm/.cat" at : /PC/drivers/

**Read the "Driver\_install02.txt" file before installing.**

---

This page provides an option to read the manual in .pdf format. PDF files can be downloaded into your hard disk, then viewed and printed with Acrobat Reader or through your browser.

If you do not have Adobe® Acrobat Reader installed, click on the link to install the application. [Adobe® Acrobat Reader for PC](#) / [Adobe® Acrobat Reader for Mac](#).

### ***Download instructions:***

To download the file:

1. Click-and-hold your mouse over the icon below. (Win95/98/2000/Me/XP users right-click)

Download



[150T4.pdf](#)

Download



[170T4.pdf](#)

2. From the menu that appears, choose 'Save Link As...', 'Save Target As...' or 'Download Link to Disk'.
3. Choose where you would like to save the file; click 'Save' (if prompted to save as either 'text' or 'source', choose 'source').

### ***Printing instructions:***

To print the manual:

1. With the manual file open, follow your printer's instructions and print the pages you need.

[RETURN TO TOP OF THE PAGE](#)

---

## **Installing FPadjust Program**

The FP Adjust program generates alignment patterns which will help you adjust monitor settings such as CONTRAST, BRIGHTNESS, HORIZONTAL & VERTICAL POSITION, PHASE and CLOCK.

### *System requirements:*

- PC running Windows® 95, Windows® 98, Windows® 2000, Windows® Me, Windows® XP or later

### *To install [FPadjust Program](#):*

- Click on the link or icon to install FPadjustment Program.
- or
- Click-and-hold your mouse over the icon. (Win95/98/2000/Me/XP users right-click)

**Download**



[FP\\_setup03.exe](#)

- From the menu that appears, choose 'Save Link As...', 'Save Target As...' or 'Download Link to Disk'.
- Choose where you would like to save the file; click 'Save' (if prompted to save as either 'text' or

'source', choose 'source').

- Exit your browser and install the FPadjust Program.

**Read the "FP\_Readme03.txt" file before installing.**

[RETURN TO TOP OF THE PAGE](#)

# FAQs (Frequently Asked Questions)

[Safety and Troubleshooting](#) • [General FAQs](#) • [Screen Adjustments](#) • [Compatibility with Other Peripherals](#) • [LCD Panel Technology](#) • [Ergonomics, Ecology and Safety Standards](#) • [Troubleshooting](#) • [Regulatory Information](#) • [Other Related Information](#)

---

## General FAQs

**Q:** When I install my monitor what should I do if the screen shows 'Cannot display this video mode'?

**A:** Recommended video mode for Philips 15": 1024x768 @60Hz.

1. Unplug all cables, then connect your PC to the monitor you used previously, which displayed correctly.
  2. In the Windows® Start Menu, select Settings/Control Panel. In the Control Panel Window, select the Display icon. Inside the Display Control Panel, select the 'Settings' tab. Under the settings tab, in a box labelled 'desktop area', move the sidebar to 1024x768 pixels (15").
  3. Open 'Advanced Properties' and set the Refresh Rate to 60Hz, then click OK.
  4. Restart your computer and repeat steps 2 and 3 to verify that your PC is set at 1024x768@60Hz (15").
  5. Shut down your computer, disconnect your old monitor and reconnect your Philips LCD monitor.
  6. Turn on your monitor and then turn on your PC.
- 

**Q:** What does 'refresh rate' mean in connection with an LCD monitor?

**A:** The refresh rate is of much less relevance for LCD monitors. LCD monitors display a stable, flicker-free image at 60Hz. There is no visible difference between 75Hz and 60Hz.

---

**Q:** What are the .inf and .icm files on the set-up disk & CD-ROM? How do I install the drivers (.inf and .icm)?

**A:** These are the driver files for your monitor. Follow the instructions in your user manual to install the drivers. The computer may ask you for monitor drivers (.inf and .icm files) or a driver disk when you first install your monitor. Follow the instructions to insert the driver disk (either floppy or CD-



ROM) included in this package. Monitor drivers (.inf and .icm files) will be installed automatically.

---

**Q:** How do I adjust the resolution?

**A:** Your video card/graphic driver and monitor together determine the available resolutions. You can select the desired resolution under Windows® 95/98 Me & 2000/XP with the 'Display properties/Settings' control panel.

---

**Q:** What if I get lost when I am making monitor adjustments?

**A:** Simply press the OSD button, then select 'Reset' to recall all of the original factory settings.

---

**Q:** My Monitor has no power (Power LED does not light up). What should I do?

**A:** Make sure the power cord is connected to the Monitor.

---

**Q:** Will the product accept an Interlace signal?

**A:** No. If an Interlace signal is used, the screen displays both odd and even horizontal scanning lines at the same time, thus distorting the picture.

---

**Q:** What does the Refresh Rate mean for LCD?

**A:** Unlike CRT display technology, in which the speed of the electron beam is swept from the top to the bottom of the screen determines flicker, an active matrix display uses an active element (TFT) to control each individual pixel and the refresh rate is therefore not really applicable to LCD technology.

---

**Q:** Will the LCD screen be resistant to scratches?

**A:** A protective coating is applied to the surface of the LCD, which is durable to a certain extent (approximately up to the hardness of a 2H pencil). In general, it is recommended that the panel surface is not subject to any excessive shocks or scratches. An optional protective cover with greater scratch resistance is also available.

---

**Q:** How should I clean the LCD surface?

**A:** For normal cleaning, use a clean, soft cloth. For extensive cleaning, please use isopropyl alcohol. Do not use other solvents such as ethyl alcohol, ethanol, acetone, hexane, etc.

---

**Q:** Can the Philips LCD Monitor be mounted on the wall or used as a touch panel?

**A:** Yes. Philips LCD monitors have this optional feature. The standard VESA mount holes on the back cover allows the user to mount the Philips monitor on any VESA standard ARM or accessories. Touch panels are being developed for future applications. Check with your Philips sales representative for more information.

[RETURN TO TOP OF THE PAGE](#)

---

## Screen Adjustments

**Q:** What is the FPadjust program on the setup disk and CD-ROM?

**A:** The FPadjust program generates alignment patterns that help you adjust monitor settings such as Contrast, Brightness, Horizontal Position, Vertical Position, Phase and Clock for optimal performance.

---

**Q:** When I install my monitor, how do I get the best performance from the monitor?

**A:**

1. For best performance, make sure your display settings are set at 1024x768@60Hz for 15". Note: You can check the current display settings by pressing the OSD OK button once. The current display mode is shown in the product information in the OSD main controls.
  2. To install the Flat Panel Adjust (FPadjust) program located on the monitor setup CD-ROM, open the CD-ROM and double click the FP\_setup03.exe icon. This will install FP Adjust automatically and place a shortcut on your desktop.
  3. Run FPadjust by double clicking the shortcut. Follow the instructions step by step to optimise image performance with your system's video controller.
- 

**Q:** How do LCDs compare with CRTs in terms of radiation?

**A:** Because LCDs do not use an electron gun, they do not generate the same amount of radiation at the screen surface.

[RETURN TO TOP OF THE PAGE](#)

---

## Compatibility with other Peripherals

**Q:** Can I connect my LCD monitor to any PC, workstation or Mac?

**A:** Yes. All Philips LCD monitors are fully compatible with standard PCs, Macs and workstations. You may need a cable adapter to connect the monitor to your Mac system. Please contact your dealer/retailer for more information.

---

**Q:** Are Philips LCD monitors Plug-and-Play?

**A:** Yes, the monitors are Plug-and-Play compatible with Windows® 95, 98, 2000, Me, XP and the PC98/99 platforms.

---

**Q:** What are S-VIDEO Signals?

**A:** These are 2 separate Y/C video signals from the S-VIDEO and Hi-8 recording standards. The

luminance signals Y (black and white) and chrominance signals C (colour) are recorded separately on the tape. This provides a better picture quality than is achieved with standard video (VHS and 8 mm) where the Y/C signals are combined to provide only one video signal.

[RETURN TO TOP OF THE PAGE](#)

---

## LCD Panel Technology

**Q:** What is a Liquid Crystal Display?

**A:** A Liquid Crystal Display (LCD) is an optical device that is commonly used to display ASCII characters and images on digital items such as watches, calculators, portable game consoles, etc. LCD is the technology used for displays in notebooks and other small computers. Like light-emitting diode and gas-plasma technologies, LCD allows displays to be much thinner than cathode ray tube (CRT) technology. LCD consumes much less power than LED and gas-displays because it works on the principle of blocking light rather than emitting it.

---

**Q:** How are LCDs made?

**A:** LCDs are created from two glass plates separated from each other at a distance of a few microns. The plates are filled with liquid crystal and then sealed together. The top plate is colored with an RGB pattern to make the color filter. Polarizers are then glued to both plates. This combination is sometimes called 'glass' or 'cell.' The LCD cell is assembled into a 'module' by adding the backlight, driver electronics and frame.

---

**Q:** What is polarization ?

**A:** Polarization is basically directing light to shine in one direction. Light is electromagnetic waves. Electric and magnetic fields oscillate in a direction perpendicular to the propagation of the light beam. The direction of these fields is called the 'polarization direction'. Normal or non-polarized light has fields in several directions; polarized light has a field in only one direction.

---

**Q:** What differentiates passive matrix LCDs from active matrix LCDs?

**A:** An LCD is made with either a passive matrix or an active matrix display grid. An active matrix has a transistor located at each pixel intersection, requiring less current to control the luminance of a pixel. For this reason, the current in an active matrix display can be switched on and off more frequently, improving the screen refresh time (your mouse pointer will appear to move more smoothly across the screen, for example). The passive matrix LCD has a grid of conductors with pixels located at each intersection in the grid.

---

**Q:** How does a TFT LCD Panel work?

**A:** On each column and row of the TFT LCD panel, a data source drive and a gate drive are attached, respectively. The TFT drain of each cell is connected to the electrode. The molecular arrangement of liquid crystal elements differ according to whether it is impressed with voltage or not. It varies the direction of polarized light and the amount of light by letting it through different arrays of liquid crystal elements. When two polarized filters are arranged vertically on a polarized light pole, the light that passes through the upper polarized panel is turned 90 degrees along with the spiral structure of the liquid crystal molecules and goes through the polarized filter at the bottom. When impressed with voltage, liquid crystal molecules are arranged vertically from the original spiral structure and the direction of the light is not turned through 90 degrees. In this case, light that comes through the top polarized panel may not go through the polarized panel at the bottom.

---

**Q:** What are the advantages of TFT LCD compared with CRT?

**A:** In a CRT monitor, a gun shoots electrons and general light by colliding polarized electrons on fluorescent glass. Therefore, CRT monitors basically operate with an analog RGB signal. A TFT LCD monitor is a device that displays an input image by operating a liquid crystal panel. The TFT has a fundamentally different structure than a CRT: Each cell has an active matrix structure and independent active elements. A TFT LCD has two glass panels and the space between them is filled with liquid crystal. When each cell is connected with electrodes and impressed with voltage, the molecular structure of the liquid crystal is altered and controls the amount of inlet lighting to display images. A TFT LCD has several advantages over a CRT, since it can be very thin and no flickering occurs because it does not use the scanning method.

---

**Q:** Why is a vertical frequency of 60Hz optimal for an LCD monitor?

**A:** Unlike a CRT monitor, the TFT LCD panel has a fixed resolution. For example, an XGA monitor

has 1024x3 (R, G, B) x 768 pixels and a higher resolution may not be available without additional software processing. The panel is designed to optimise the display for a 65MHz dot clock, one of the standards for XGA displays. Since the vertical/horizontal frequency for this dot clock is 60Hz/48kHz, the optimum frequency for this monitor is 60Hz.

---

**Q:** What kind of wide-angle technology is available? How does it work?

**A:** The TFT LCD panel is an element that controls/displays the inlet of a backlight using the dual-refraction of a liquid crystal. Using the property that the projection of inlet light refracts toward the major axis of the liquid element, it controls the direction of inlet light and displays it. Since the refraction ratio of inlet light on liquid crystal varies with the inlet angle of the light, the viewing angle of a TFT is much narrower than that of a CDT. Usually, the viewing angle refers to the point where the contrast ratio is 10. Many ways to widen the viewing angle are currently being developed and the most common approach is to use a wide viewing angle film, which widens the viewing angle by varying the refraction ratio. IPS (In Plane Switching) or MVA (Multi Vertical Aligned) is also used to give a wider viewing angle.

---

**Q:** Why is there no flicker on an LCD Monitor?

**A:** Technically speaking, LCDs do flicker, but the cause of the phenomenon is different from that of a CRT monitor -- and it has no impact of the ease of viewing. Flickering in an LCD monitor relates to usually undetectable luminance caused by the difference between positive and negative voltage. On the other hand, CRT flickering that can irritate the human eye occurs when the on/off action of the fluorescent object becomes visible. Since the reaction speed of liquid crystal in an LCD panel is much slower, this troublesome form of flickering is not present in an LCD display.

---

**Q:** Why is an LCD monitor virtually free of Electro Magnetic Interference?

**A:** Unlike a CRT, an LCD monitor does not have key parts that generate Electro Magnetic Interference, especially magnetic fields. Also, since an LCD display utilizes relatively low power, its power supply is extremely quiet.

[RETURN TO TOP OF THE PAGE](#)

---

## Ergonomics, Ecology and Safety Standards

**Q:** What is the CE mark?

**A:** The CE (Conformité Européenne) mark is required to be displayed on all regulated products offered for sale on the European market. This 'CE' mark means that a product complies with the relevant European Directive. A European Directive is a European 'Law' that relates to health, safety, environment and consumer protection, much the same as the U.S. National Electrical Code and UL Standards.

---

**Q:** Does the product conform to general safety standards?

**A:** Yes. Philips LCD monitors conform to the guidelines of MPR-II and TCO 99 standards for the control of radiation, electromagnetic waves, energy reduction, electrical safety in the work environment and recyclability. The specification page provides detailed data on safety standards.

*More information is provided in the [Regulatory Information](#) section.*

[RETURN TO TOP OF THE PAGE](#)



# Troubleshooting

[Safety and Troubleshooting](#) • [FAQs](#) • [Common Problems](#) • [Imaging Problems](#) • [TV and Audio Problems](#) • [Regulatory Information](#) • [Other Related Information](#)

This page deals with problems that can be corrected by the user. If the problem still persists after you have tried these solutions, contact your nearest Philips dealer.

<b>Common Problems</b>	
<b>Having this problem?</b>	<b>Check these items</b>
No Picture (Power LED not lit)	<ul style="list-style-type: none"> <li>● Make sure the power cord is plugged into the power outlet and into the back of the monitor.</li> </ul>
No Picture (Power LED is amber)	<ul style="list-style-type: none"> <li>● Make sure the computer is turned on.</li> <li>● Make sure the signal cable is properly connected to your computer.</li> <li>● Check to see if the monitor cable has bent pins.</li> <li>● The Energy Saving feature may be activated</li> </ul>
Screen says  	<ul style="list-style-type: none"> <li>● Make sure the monitor cable is properly connected to your computer. (Also refer to the Quick Set-Up Guide).</li> <li>● Check to see if the monitor cable has bent pins.</li> <li>● Make sure the computer is turned on.</li> </ul>
<b>Imaging Problems</b>	
Display position is incorrect	<ul style="list-style-type: none"> <li>● Press "MENU" key to select "ADJUST POSITION" control at PC mode or press "MENU" and "DOWN" hot keys at front control together to automatically adjust the position.</li> </ul>



<p>Image vibrates on the screen</p>	<ul style="list-style-type: none"> <li>● Check that the signal cable is properly connected to the graphics board or PC.</li> </ul>
<p>Vertical flicker appears</p> 	<ul style="list-style-type: none"> <li>● Press "MENU" and "DOWN" hot keys at front control together to automatically adjust at PC mode.</li> <li>● Press "MENU" key to select "AUTO".</li> </ul>
<p>Horizontal flicker appears</p> 	<ul style="list-style-type: none"> <li>● Press "MENU" and "DOWN" hot keys at front control together to automatically adjust at PC mode.</li> <li>● Press "MENU" key to select "AUTO".</li> </ul>
<p>The screen is too bright or too dark</p>	<ul style="list-style-type: none"> <li>● Adjust the contrast and brightness in OSD Main Controls. (The backlight of the product has a fixed life span. When the screen becomes dark or begins to flicker, please contact your dealer.)</li> </ul>
<p>An after-image appears</p>	<ul style="list-style-type: none"> <li>● If an image remains on the screen for an extended period of time, it may be imprinted in the screen and leave an afterimage This usually disappears after a few hours.</li> </ul>
<p>An afterimage remains after the power has been turned off.</p>	<ul style="list-style-type: none"> <li>● This is characteristic of liquid crystal and is not caused by a malfunction or deterioration of the liquid crystal. The afterimage will disappear after a period of time.</li> </ul>

Green, red, blue, dark and white dots remain.

- The remaining dots are normal characteristic of the liquid crystal used in today's technology.

## TV and Audio Problems

Poor TV signal reception

- The proximity of mountains or high buildings may be responsible for ghost pictures, echoing or shadows. In this case, try manually adjusting your pictures: see 'fine tuning' or adjust the direction of the outside aerial.  
For Asia users in non-NTSC area: Does your antenna enable you to receive broadcasts in this frequency range (UHF or VHF band)? In the event of difficult reception (snowy pictures) switch the NR on the PICTURE menu to ON.

No TV picture

- Have you connected the aerial socket properly? Have you chosen the right system? Poorly connected aerial sockets are often the cause of picture or sound problems (sometimes the connectors can become half disconnected if the Monitor set is moved or turned). Check all connections.

No sound

- Ensure that the audio cables are firmly connected to both the audio input connectors on your Monitor and audio output connectors on your PC or Video player.
- If on certain TV channels you receive a picture but no sound, this means that you do not have the correct TV system. Modify the SYSTEM setting.

For further assistance, refer to the [Consumer Information Centres](#) list and contact your local Philips distributor.

[RETURN TO TOP OF THE PAGE](#)



# Regulatory Information

[TCO '99 Information](#) • [TCO Environmental Requirements](#) • [CE Declaration of Conformity](#) • [Energy Star Declaration](#) • [Federal Communications Commission \(FCC\) Notice \(U.S. Only\)](#) • [Commission Federale de la Communication \(FCC Declaration\)](#) • [EN 55022 Compliance \(Czech Republic Only\)](#) • [VCCI Class 2 Notice \(Japan Only\)](#) • [MIC Notice \(South Korea Only\)](#) • [Polish Center for Testing and Certification Notice](#) • [North Europe \(Nordic Countries\) Information](#) • [BSMI Notice \(Taiwan Only\)](#) • [Ergonomie Hinweis \(nur Deutschland\)](#) • [Philips End-of-Life Disposal](#) • [Information for UK only](#)

[Safety and Troubleshooting](#) • [Troubleshooting](#) • [Other Related Information](#) • [Frequently Asked Questions \(FAQs\)](#)

---

## TCO '99 Information



**Congratulations!** You have just purchased a TCO '99 approved and labeled product! Your choice has provided you with a product developed for professional use. Your purchase has also contributed to reducing the burden on the environment and also to the further development of environmentally adapted electronics products.

### *Why do we have environmentally labeled computers?*

In many countries, environmental labeling has become an established method for encouraging the adaptation of goods and services to the environment. The main problem, as far as computers and other electronics equipment are concerned, is that environmentally harmful substances are used both in the products and during their manufacture. Since it is not so far possible to satisfactorily recycle the majority of electronics equipment, most of these potentially damaging substances sooner or later enter nature.

There are also other characteristics of a computer, such as energy consumption levels, that are important from the viewpoints of both the work (internal) and natural (external) environments. Since all methods of electricity generation have a negative effect on the environment (e.g. acidic and climate-influencing emissions, radioactive waste), it is vital to save energy. Electronics equipment in offices is often left running continuously and thereby consumes a lot of energy.

### *What does labeling involve?*

This product meets the requirements for the TCO'99 scheme which provides for international and environmental labeling of personal computers. The labeling scheme was developed as a joint effort by the TCO (The Swedish Confederation of Professional Employees), Svenska Naturskyddsforeningen (The Swedish Society for Nature Conservation) and Statens Energimyndighet (The Swedish National Energy Administration).

Approval requirements cover a wide range of issues: environment, ergonomics, usability, emission of electric and magnetic fields, energy consumption and electrical and fire safety.

The environmental demands impose restrictions on the presence and use of heavy metals, brominated and chlorinated flame retardants, CFCs (freons) and chlorinated solvents, among other things. The product must be prepared for recycling and the manufacturer is obliged to have an environmental policy which must be adhered to in each country where the company implements its operational policy.

The energy requirements include a demand that the computer and/or display, after a certain period of inactivity, shall reduce its power consumption to a lower level in one or more stages. The length of time to reactivate the computer shall be reasonable for the user.

Labeled products must meet strict environmental demands, for example, in respect of the reduction of electric and magnetic fields, physical and visual ergonomics and good usability.

Below you will find a brief summary of the environmental requirements met by this product. The complete environmental criteria document may be ordered from:

TCO Development

SE-114 94 Stockholm, Sweden

Fax: +46 8 782 92 07

Email (Internet): [development@tco.se](mailto:development@tco.se)

*Current information regarding TCO'99 approved and labeled products may also be obtained via the Internet, using the address: <http://www.tco-info.com/>*

[RETURN TO TOP OF THE PAGE](#)

---

## Environmental Requirements

### *Flame retardants*

Flame retardants are present in printed circuit boards, cables, wires, casings and housings. Their purpose is to prevent, or at least to delay the spread of fire. Up to 30% of the plastic in a computer casing can consist of flame retardant substances. Most flame retardants contain bromine or chloride, and those flame retardants are chemically related to another group of environmental toxins, PCBs. Both the flame retardants containing bromine or chloride and the PCBs are suspected of giving rise to severe health effects, including reproductive damage in fish-eating birds and mammals, due to the bio-accumulative\* processes. Flame retardants have been found in human blood and researchers fear that disturbances in fetus development may occur.

The relevant TCO'99 demand requires that plastic components weighing more than 25 grams must not contain flame retardants with organically bound bromine or chlorine. Flame retardants are allowed in the printed circuit boards since no substitutes are available.

### **Cadmium\*\***

Cadmium is present in rechargeable batteries and in the color-generating layers of certain computer displays. Cadmium damages the nervous system and is toxic in high doses. The relevant TCO'99 requirement states that batteries, the color-generating layers of display screens and the electrical or electronics components must not contain any cadmium.

### **Mercury\*\***

Mercury is sometimes found in batteries, relays and switches. It damages the nervous system and is toxic in high doses. The relevant TCO'99 requirement states that batteries may not contain any mercury. It also demands that mercury is not present in any of the electrical or electronics components associated with the labeled unit.

### **CFCs (freons)**

The relevant TCO'99 requirement states that neither CFCs nor HCFCs may be used during the manufacture and assembly of the product. CFCs (freons) are sometimes used for washing printed circuit boards. CFCs break down ozone and thereby damage the ozone layer in the stratosphere, causing increased reception on earth of ultraviolet light with increased risks e.g. skin cancer (malignant melanoma) as a consequence.

### **Lead\*\***

Lead can be found in picture tubes, display screens, solders and capacitors. Lead damages the nervous system and in higher doses, causes lead poisoning. The relevant TCO'99 requirement permits the inclusion of lead since no replacement has yet been developed.

**\* Bio-accumulative is defined as substances which accumulate within living organisms.**

**\*\* Lead, Cadmium and Mercury are heavy metals which are bio-accumulative.**

[RETURN TO TOP OF THE PAGE](#)

---

## **CE Declaration of Conformity**

Philips Consumer Electronics declare under our responsibility that the product is in conformity with the following standards

- EN60950:2000 (Safety requirement of Information Technology Equipment)

- EN55022:1998 (Radio Disturbance requirement of Information Technology Equipment)
  - EN55024:1998 (Immunity requirement of Information Technology Equipment)
  - EN61000-3-2:2000 (Limits for Harmonic Current Emission)
  - EN61000-3-3:1995+A1 (Limitation of Voltage Fluctuation and Flicker)
  - EN55013:2001 (Radio Disturbance requirement of Sound and Television Receivers and associated)
  - EN55020:2002+A1 (Immunity requirement of Sound and Television Receivers and associated)
  - IEC Guide 112:2000 (Guide on the Safety of Multimedia Equipment) following provisions of directives applicable
  - 73/23/EEC (Low Voltage Directive)
  - 89/336/EEC (EMC Directive)
  - 93/68/EEC (Amendment of EMC and Low Voltage Directive)
- and is produced by a manufacturing organization on ISO9000 level.

The product also comply with the following standards

- ISO9241-3, ISO9241-7, ISO9241-8 (Ergonomic requirement for Visual Display)
- ISO13406-2 (Ergonomic requirement for Flat panels)
- GS EK1-2000 (GS specification)
- prEN50279:1998 (Low Frequency Electric and Magnetic fields for Visual Display)
- MPR-II (MPR:1990:8/1990:10 Low Frequency Electric and Magnetic fields)
- TCO95, TCO99 (Requirement for Environment Labelling of Ergonomics, Energy, Ecology and Emission, TCO: Swedish Confederation of Professional Employees) for TCO versions

[RETURN TO TOP OF THE PAGE](#)

---

## Energy Star Declaration

### **PHILIPS 150T4**

This monitor is equipped with a function for saving energy which supports the VESA Display Power Management Signaling (DPMS) standard. This means that the monitor must be connected to a computer which supports VESA DPMS to fulfill the requirements in the NUTEK specification 803299/94. Time settings are adjusted from the system unit by software.

NUTEK	VESA State	LED Indicator	Power Consumption
Normal operation	ON	Blue	25 W (typical)

Power Saving  
Alternative 2  
One step

OFF

Amber

110VAC < 1W  
230VAC < 2W



As an ENERGY STAR® Partner, PHILIPS has determined that this product meets the ENERGY STAR® guidelines for energy efficiency.



We recommend you switch off the monitor when it is not in use for quite a long time.

[RETURN TO TOP OF THE PAGE](#)

## Federal Communications Commission (FCC) Notice (U.S. Only)



This equipment has been tested and found to comply with the limits for a Class B digital device, pursuant to Part 15 of the FCC Rules. These limits are designed to provide reasonable protection against harmful interference in a residential installation. This equipment generates, uses and can radiate radio frequency energy and, if not installed and used in accordance with the instructions, may cause harmful interference to radio communications. However, there is no guarantee that interference will not occur in a particular installation. If this equipment does cause harmful interference to radio or television reception, which can be determined by turning the equipment off and on, the user is encouraged to try to correct the interference by one or more of the following measures:

- Reorient or relocate the receiving antenna.
- Increase the separation between the equipment and receiver.
- Connect the equipment into an outlet on a circuit different from that to which the receiver is connected.
- Consult the dealer or an experienced radio/TV technician for help.



Changes or modifications not expressly approved by the party responsible for compliance could void the user's authority to operate the equipment.

Use only RF shielded cable that was supplied with the monitor when connecting this monitor to a computer device.

To prevent damage which may result in fire or shock hazard, do not expose this appliance to rain or excessive moisture.

THIS CLASS B DIGITAL APPARATUS MEETS ALL REQUIREMENTS OF THE CANADIAN INTERFERENCE-CAUSING EQUIPMENT REGULATIONS.



[RETURN TO TOP OF THE PAGE](#)

---

## Commission Federale de la Communication (FCC Declaration)



Cet équipement a été testé et déclaré conforme aux limites des appareils numériques de class B, aux termes de l'article 15 Des règles de la FCC. Ces limites sont conçues de façon à fournir une protection raisonnable contre les interférences nuisibles dans le cadre d'une installation résidentielle. CET appareil produit, utilise et peut émettre des hyperfréquences qui, si l'appareil n'est pas installé et utilisé selon les consignes données, peuvent causer des interférences nuisibles aux communications radio. Cependant, rien ne peut garantir l'absence d'interférences dans le cadre d'une installation particulière. Si cet appareil est la cause d'interférences nuisibles pour la réception des signaux de radio ou de télévision, ce qui peut être décelé en fermant l'équipement, puis en le remettant en fonction, l'utilisateur pourrait essayer de corriger la situation en prenant les mesures suivantes:

- Réorienter ou déplacer l'antenne de réception.
- Augmenter la distance entre l'équipement et le récepteur.
- Brancher l'équipement sur un autre circuit que celui utilisé par le récepteur.
- Demander l'aide du marchand ou d'un technicien chevronné en radio/télévision.



Toutes modifications n'ayant pas reçu l'approbation des services compétents en matière de conformité est susceptible d'interdire à l'utilisateur l'usage du présent équipement.

N'utiliser que des câbles RF armés pour les connections avec des ordinateurs ou périphériques.

CET APPAREIL NUMERIQUE DE LA CLASSE B RESPECTE TOUTES LES EXIGENCES DU REGLEMENT SUR LE MATERIEL BROUILLEUR DU CANADA.

[RETURN TO TOP OF THE PAGE](#)

---

## EN 55022 Compliance (Czech Republic Only)

This device belongs to category B devices as described in EN 55022, unless it is specifically stated that it is a Class A device on the specification label. The following applies to devices in Class A of EN 55022 (radius of protection up to 30 meters). The user of the device is obliged to take all steps necessary to remove sources of interference to telecommunication or other devices.

Pokud není na typovém štítku počítače uvedeno, že spadá do do třídy A podle EN 55022, spadá automaticky do třídy B podle EN 55022. Pro zařízení zařazená do třídy A (chranné pásmo 30m) podle EN 55022 platí následující. Dojde-li k rušení telekomunikačních nebo jiných zařízení je uživatel povinen provést taková opatření, aby rušení odstranil.

[RETURN TO TOP OF THE PAGE](#)

---

## VCCI Notice (Japan Only)

This is a Class B product based on the standard of the Voluntary Control Council for Interference (VCCI) for Information technology equipment. If this equipment is used near a radio or television receiver in a domestic environment, it may cause radio Interference. Install and use the equipment according to the instruction manual.



Class B ITE

この装置は、情報処理装置等電波障害自主規制協議会 (VCCI) の基準に基づくクラス B 情報技術装置です。この装置は家庭環境で使用することを目的としていますが、この装置がラジオやテレビジョン受信機に近接して使用されると、受信障害を引き起こすことがあります。取扱説明書に従って正しい取り扱いをして下さい。

[RETURN TO TOP OF THE PAGE](#)

---

## MIC Notice (South Korea Only)

Class B Device

장치 종류	사용자 안내문
B급 기기	이 장치는 가정용으로 전자파 적합등록을 한 장치로서 주거지역에서는 물론 모든 지역에서 사용할 수 있습니다.



Please note that this device has been approved for non-business purposes and may be used in any environment, including residential areas.

[RETURN TO TOP OF THE PAGE](#)

## Polish Center for Testing and Certification Notice

The equipment should draw power from a socket with an attached protection circuit (a three-prong socket). All equipment that works together (computer, monitor, printer, and so on) should have the same power supply source.

The phasing conductor of the room's electrical installation should have a reserve short-circuit protection device in the form of a fuse with a nominal value no larger than 16 amperes (A).

To completely switch off the equipment, the power supply cable must be removed from the power supply socket, which should be located near the equipment and easily accessible.

A protection mark "B" confirms that the equipment is in compliance with the protection usage requirements of standards PN-93/T-42107 and PN-89/E-06251.

## ***Wymagania Polskiego Centrum Badań i Certyfikacji***

Urządzenie powinno być zasilane z gniazda z przyłączonym obwodem ochronnym (gniazdo z kolkiem). Współpracujące ze sobą urządzenia (komputer, monitor, drukarka) powinny być zasilane z tego samego źródła.

Instalacja elektryczna pomieszczenia powinna zawierać w przewodzie fazowym rezerwową ochronę przed zwarciami, w postaci bezpiecznika o wartości znamionowej nie większej niż 16A (amperów).

W celu całkowitego wyłączenia urządzenia z sieci zasilania, należy wyjąć wtyczkę kabla zasilającego z gniazdko, które powinno znajdować się w pobliżu urządzenia i być łatwo dostępne.

Znak bezpieczeństwa "B" potwierdza zgodność urządzenia z wymaganiami bezpieczeństwa użytkowania zawartymi w PN-93/T-42107 i PN-89/E-06251.

## ***Pozostałe instrukcje bezpieczeństwa***

- Nie należy używać wtyczek adapterowych lub usuwać kolka obwodu ochronnego z wtyczki. Jeżeli konieczne jest użycie przedłużacza to należy użyć przedłużacza 3-żyłowego z prawidłowo połączonym przewodem ochronnym.
- System komputerowy należy zabezpieczyć przed nagłymi, chwilowymi wzrostami lub spadkami napięcia, używając eliminatora przepięć, urządzenia dopasowującego lub bezzakłócenowego źródła zasilania.
- Należy upewnić się, aby nic nie leżało na kablach systemu komputerowego, oraz aby kable nie były umieszczone w miejscu, gdzie można byłoby na nie nadeptywać lub potykać się o nie.
- Nie należy rozlewać napojów ani innych płynów na system komputerowy.
- Nie należy wpychać żadnych przedmiotów do otworów systemu komputerowego, gdyż może to spowodować pożar lub porażenie prądem, poprzez zwarcie elementów wewnętrznych.
- System komputerowy powinien znajdować się z dala od grzejników i źródeł ciepła. Ponadto, nie należy blokować otworów wentylacyjnych. Należy unikać kładzenia luźnych papierów pod komputer oraz umieszczania komputera w ciasnym miejscu bez możliwości cyrkulacji powietrza wokół niego.

[RETURN TO TOP OF THE PAGE](#)

---

## **North Europe (Nordic Countries) Information**

Placering/Ventilation

### **VARNING:**

**FÖRSÄKRA DIG OM ATT HUVUDBRYTARE OCH UTTAG ÄR LÄTÅTKOMLIGA, NÄR DU STÄLLER DIN UTRUSTNING PÅPLATS.**

## Placering/Ventilation

### **ADVARSEL:**

SØRG VED PLACERINGS- OG VENTILASJONEN FOR, AT NETLEDNINGENS STIK OG STIKKONTAKT ER NEMT TILGÆNGLIGE.

## Paikka/Ilmankierto

### **VAROITUS:**

SIJOITA LAITE SITEN, ETTÄ VERKKOJOHTO VOIDAAN TARVITTAESSA HELPOSTI IRROTTAA PISTORASIESTA.

## Plassering/Ventilasjon

### **ADVARSEL:**

NÅR DETTE UTSTYRET PLOSSERES, MÅ DU PASSE PÅ AT KONTAKTENE FOR STØMTILFØRSEL ER LETTE Å NÅ.

[RETURN TO TOP OF THE PAGE](#)

---

## **BSMI Notice (Taiwan Only)**

符合乙類資訊產品之標準

[RETURN TO TOP OF THE PAGE](#)

## Ergonomie Hinweis (nur Deutschland)

Damit Ihr Monitor immer den in der Zulassung geforderten Werten entspricht, ist darauf zu achten, daß

1. Reparaturen nur durch Fachpersonal durchgeführt werden.
2. nur original-Ersatzteile verwendet werden.
3. bei Ersatz der Bildröhre nur eine bauartgleiche eingebaut wird.

Aus ergonomischen Gründen wird empfohlen, die Grundfarben Blau und Rot nicht auf dunklem Untergrund zu verwenden (schlechte Lesbarkeit und erhöhte Augenbelastung bei zu geringem Zeichenkontrast wären die Folge).

Der arbeitsplatzbezogene Schalldruckpegel nach DIN 45 635 beträgt 70dB (A) oder weniger.



**ACHTUNG: BEIM AUFSTELLEN DIESES GERÄTES DARAUFG ACHTEN, DAß NETZSTECKER UND NETZKABELANSCHLUß LEICHT ZUGÄNGLICH SIND.**

[RETURN TO TOP OF THE PAGE](#)

---

## End-of-Life Disposal

Your new monitor contains materials that can be recycled and reused. Specialized companies can recycle your product to increase the amount of reusable materials and to minimize the amount to be disposed of.

Please find out about the local regulations on how to dispose of your old monitor from your local Philips dealer.

### (For customers in Canada and U.S.A.)

This product may contain lead and/or mercury. Dispose of in accordance to local-state and federal regulations. For additional information on recycling contact [www.eia.org](http://www.eia.org) (Consumer Education Initiative)

[RETURN TO TOP OF THE PAGE](#)

---

## Information for UK only

## **WARNING - THIS APPLIANCE MUST BE EARTHED.**

### **Important:**

This apparatus is supplied with an approved moulded 13A plug. To change a fuse in this type of plug proceed as follows:

1. Remove fuse cover and fuse.
2. Fit new fuse which should be a BS 1362 5A, A.S.T.A. or BSI approved type.
3. Refit the fuse cover.

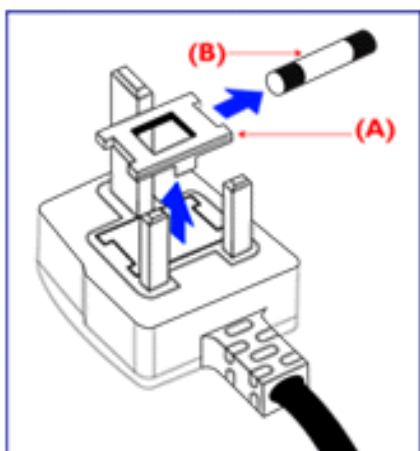

If the fitted plug is not suitable for your socket outlets, it should be cut off and an appropriate 3-pin plug fitted in its place.

If the mains plug contains a fuse, this should have a value of 5A. If a plug without a fuse is used, the fuse at the distribution board should not be greater than 5A.

Note: The severed plug must be destroyed to avoid a possible shock hazard should it be inserted into a 13A socket elsewhere.

### **How to connect a plug**

The wires in the mains lead are coloured in accordance with the following code:

BLUE - "NEUTRAL" ("N")

BROWN - "LIVE" ("L")

GREEN & YELLOW - "EARTH" ("E")

1. The GREEN AND YELLOW wire must be

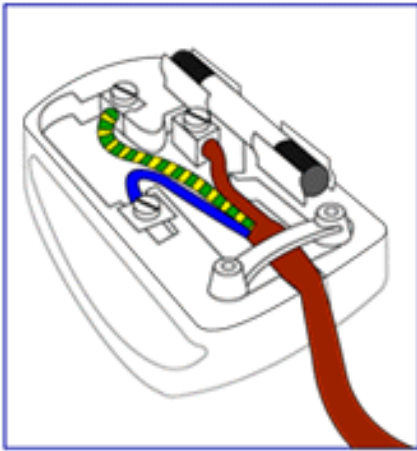

connected to the terminal in the plug which is marked with the letter "E" or by the Earth symbol  or coloured GREEN or GREEN AND YELLOW.

2. The BLUE wire must be connected to the terminal which is marked with the letter "N" or coloured BLACK.

3. The BROWN wire must be connected to the terminal which marked with the letter "L" or coloured RED.

Before replacing the plug cover, make certain that the cord grip is clamped over the sheath of the lead - not simply over the three wires.

[RETURN TO TOP OF THE PAGE](#)



# Other Related Information

[Safety and Troubleshooting](#) • [FAQs](#) • [Troubleshooting](#) • [Regulatory Information](#) • [Information for Users in the U. S.](#) • [Information for Users Outside the U.S](#)

---

## Information for Users in the U. S.

*For units set at 115 V :*

Use a UL Listed Cord Set consisting of a minimum 18 AWG, Type SVT or SJT three conductor cord a maximum of 15-feet long and a parallel blade, grounding type attachment plug rated 15 A, 125 V.

*For units set at 230 V:*

Use a UL Listed Cord Set consisting of a minimum 18 AWG, Type SVT or SJT three conductor cord a maximum of 15-feet long and a tandem blade, grounding type attachment plug rated 15 A, 250 V.

---

## Information for Users outside the U.S.

*For units set at 230 V:*

Use a Cord Set consisting of a minimum 18 AWG cord and grounding type attachment plug rated 15 A, 250 V. The Cord Set should have the appropriate safety approvals for the country in which the equipment will be installed and / or be marked HAR.

[RETURN TO TOP OF THE PAGE](#)

# Philips Pixel Defect Policy

[Product Features](#) • [Technical Specifications](#) • [Resolution & Preset Modes](#) • [Automatic Power Saving](#) • [Physical Specification](#) • [Pin Assignment](#) • [Product Views](#)

---

## Philips' LCD Panel Pixel Defect Policy

Philips strives to deliver the highest quality products. We use some of the industry's most advanced manufacturing processes and practice stringent quality control. However, pixel or sub pixel defects on the TFT LCD panels used in flat panel monitors are sometimes unavoidable. No manufacturer can guarantee that all panels will be free from pixel defects, but Philips guarantees that any monitor with an unacceptable number of defects will be repaired or replaced under warranty. This notice explains the different types of pixel defects and defines acceptable defect levels for each type. In order to qualify for repair or replacement under warranty, the number of pixel defects on a TFT LCD panel must exceed these acceptable levels. For example, no more than 0.0004% of the sub pixels on a 15" XGA monitor may be defective. Furthermore, Philips sets even higher quality standards for certain types or combinations of pixel defects that are more noticeable than others. This policy is valid worldwide.

### Pixels and Sub pixels

A pixel, or picture element, is composed of three sub pixels in the primary colors of red, green and blue. Many pixels together form an image. When all sub pixels of a pixel are lit, the three colored subpixels together appear as a single white pixel. When all are dark, the three colored sub pixels together appear as a single black pixel. Other combinations of lit and dark sub pixels appear as single pixels of other colors.

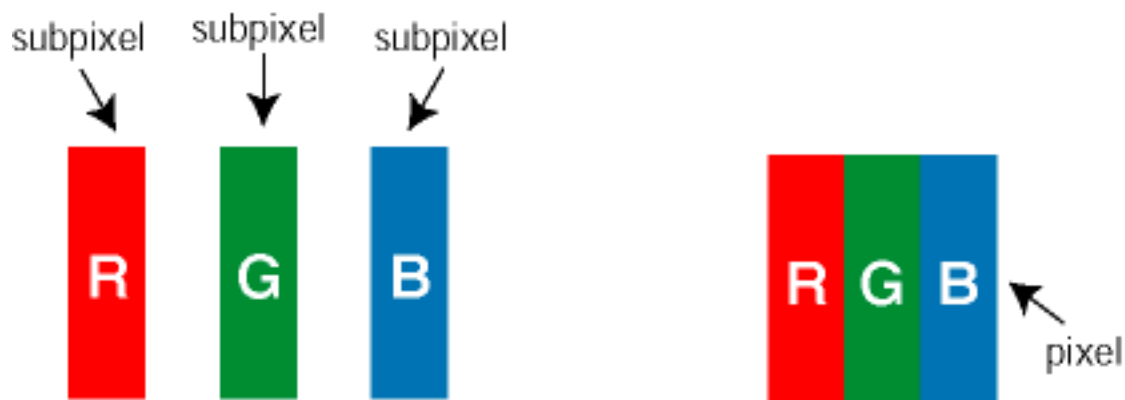

## Types of Pixel Defects

Pixel and sub pixel defects appear on the screen in different ways. There are two categories of pixel defects and several types of sub pixel defects within each category.

**Bright Dot Defects** appear as pixels or sub pixels that are always lit or 'on'. These are the types of bright dot defects:

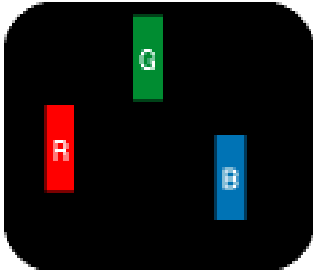

One lit red, green or blue sub pixel

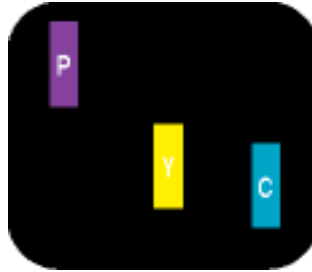

Two adjacent lit sub pixels:

- Red + Blue = Purple
- Red + Green = Yellow
- Green + Blue = Cyan (Light Blue)



Three adjacent lit sub pixels (one white pixel)

**Black Dot Defects** appear as pixels or sub pixels that are always dark or 'off'. These are the types of black dot defects:

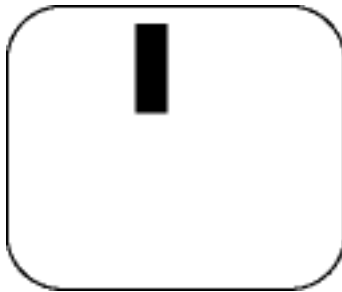

One dark sub pixel

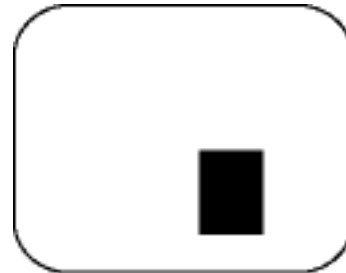

Two or three adjacent dark sub pixels

## Proximity of Pixel Defects

Because pixel and sub pixels defects of the same type that are near to one another may be more noticeable, Philips also specifies tolerances for the proximity of pixel defects.

## Pixel Defect Tolerances

In order to qualify for repair or replacement due to pixel defects during the warranty period, a TFT LCD panel in a Philips flat panel monitor must have pixel or sub pixel defects exceeding the tolerances listed in the following tables.

<b>BRIGHT DOT DEFECTS</b>	<b>ACCEPTABLE LEVEL</b>
<i>MODEL</i>	<b>150T4/170T4</b>
1 lit sub pixel	4 or fewer
2 adjacent lit sub pixels	2 or fewer
3 adjacent lit sub pixels (one white pixel)	0
Distance between two bright dot defects*	15 mm or more
Total bright dot defects of all types	4 or fewer

<b>BLACK DOT DEFECTS</b>	<b>ACCEPTABLE LEVEL</b>
<i>MODEL</i>	<b>150T4/170T4</b>
1 dark sub pixel	4 or fewer
2 adjacent dark sub pixels	2 or fewer
3 adjacent dark sub pixels	0
Distance between two black dot defects*	15 mm or more
Total black dot defects of all types	4 or fewer

<b>TOTAL DOT DEFECTS</b>	<b>ACCEPTABLE LEVEL</b>
<i>MODEL</i>	<b>150T4/170T4</b>
Total bright or black dot defects of all types	5 or fewer

*Note:*

*\* 1 or 2 adjacent sub pixel defects = 1 dot defect*

*All Philips monitors are ISO13406-2 Compliant*

[RETURN TO TOP OF THE PAGE](#)

# Connecting to Your PC, TV Antenna, DVD/VCR etc.

[Front View Product Description](#) • [Accessory Pack](#) • [Connecting to Your PC, TV Antenna, DVD/VCR etc.](#) • [VESA Mounting and Easy Wall Mounting](#) • [Installing the Optional TV/AV Module](#) • [Getting Started](#) • [Optimizing Performance](#)

[Using the Cable Management](#) • [To attach and remove back cover](#)

## Accessory Pack

Unpack all the parts.

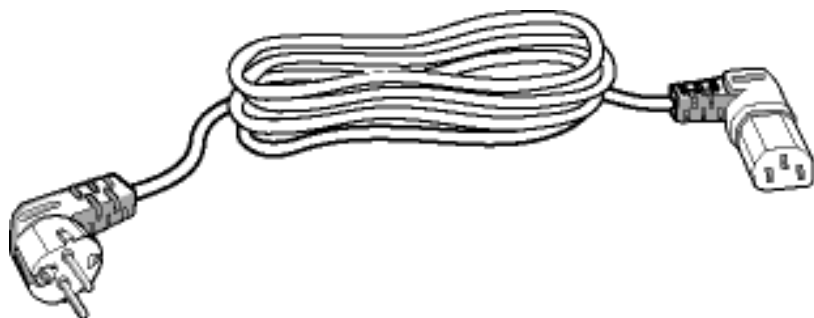

Power cable

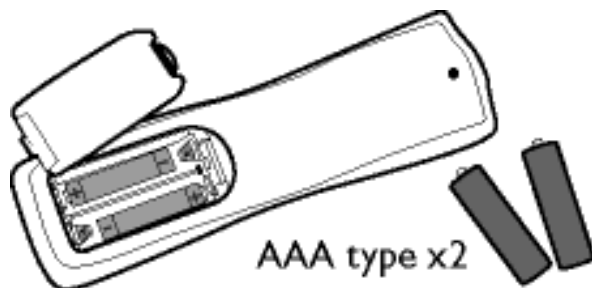

Remote control & batteries



PC audio-in cable



VGA signal cable

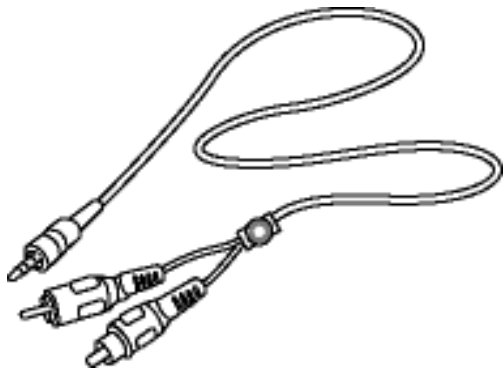

Mini jack to RCA audio-in cable

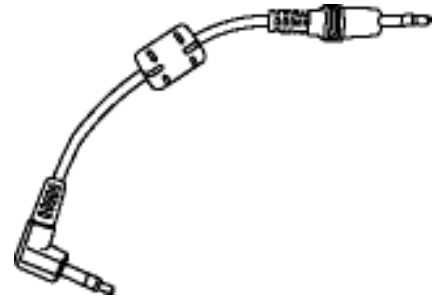

Audio Chin cable



D-SUB to YPbPr adapter cable



E-DFU pack

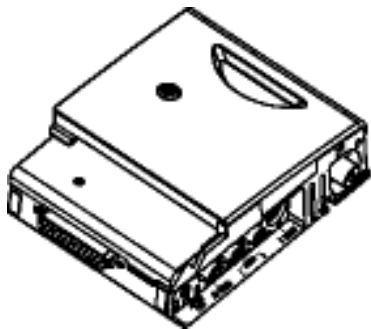

TV/AV module



Security screw for TV module

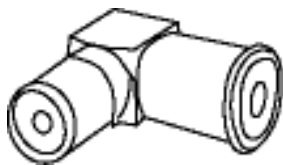

**Tuner adapter**

**Wall mount kit**

[RETURN TO TOP OF THE PAGE](#)

## Setting up and connecting your monitor/TV

Ensure that the power to the monitor/TV is switched off before the installation.

### A) Connecting to PC computer

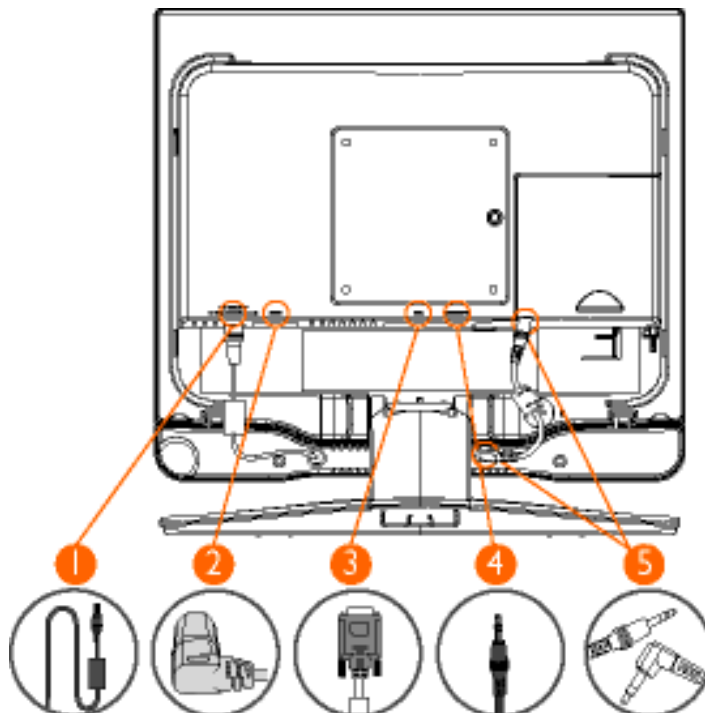





1. Make sure the external speaker power cable is plugged into the DC 12V OUT connector on the back of the monitor.
2. Connect the power cord to the AC IN power connector on the back of the monitor.
3. Connect the 15-pin D-SUB of the video signal cable to the VGA connector on the back of the monitor  
*Note: If you use an Apple Macintosh™, you need to connect the special Mac adapter to one end of the monitor signal cable.*
4. Connect the stereo audio cable to PC AUDIO IN on the back of the monitor and the other end to AUDIO OUT terminal of the sound card on your PC.
5. Connect one end of Audio Chin cable to AUDIO OUT connectors on the back of the monitor and the other to AUDIO IN on the back of the speaker.  
*Note: If necessary, please install monitor driver contained on the accompanied CD. For driver installation, see the Monitor Driver Installation section ([Getting Started](#)).*

[RETURN TO TOP OF THE PAGE](#)

---

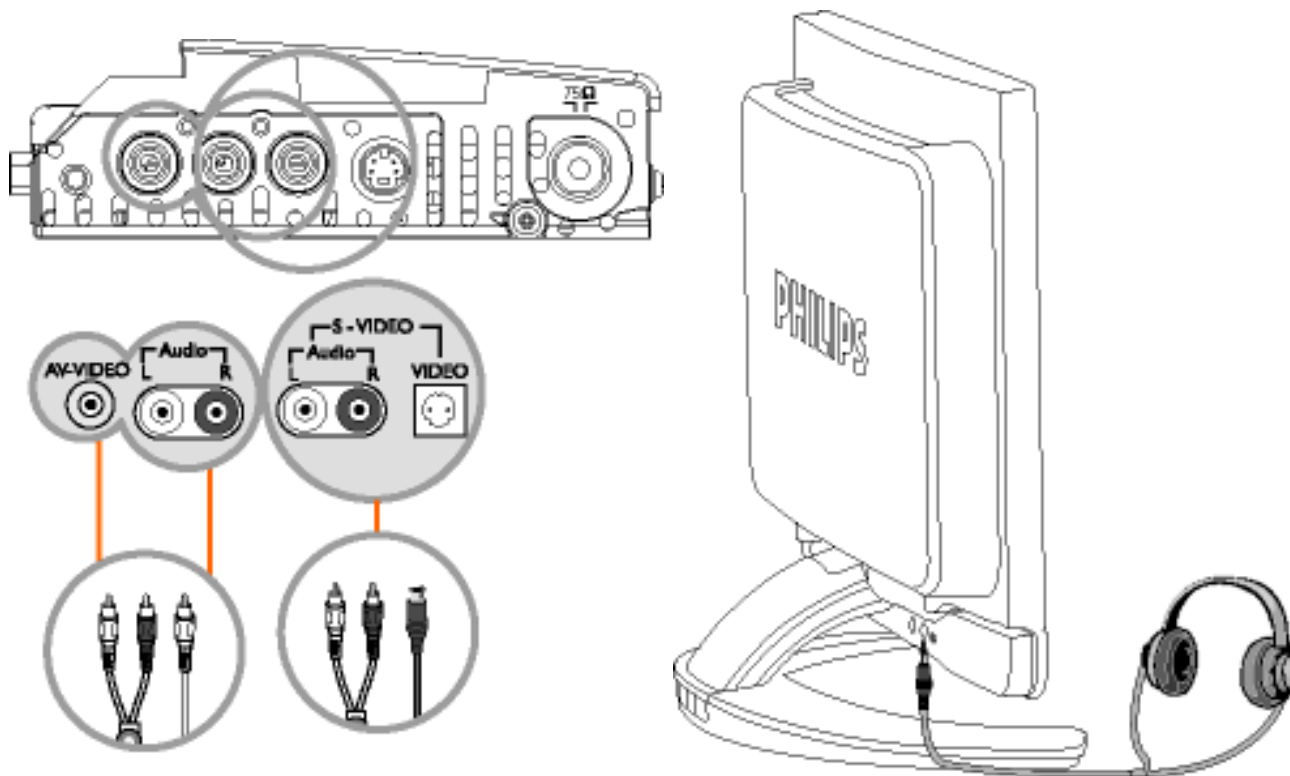
## **B) Connecting to a external A/V device such as a DVD/VCR/VCD**



1. Connect RCA (Yellow) or S-VHS cable to an appropriate external AV device such as DVD/VCR.
2. Connect RCA audio cable to AUDIO (R) and AUDIO (L) terminal and the other ends to corresponding audio out terminals on the AV device.
3. Headphone may be connected to the headphone output on the back of the monitor marked . While the headphone is connected, the sound from the external speakers will be disabled.

[RETURN TO TOP OF THE PAGE](#)

---

### **C) Connecting to progressive DVD/Setup Box through YPbPr component input (while monitor is not connected to a PC)**

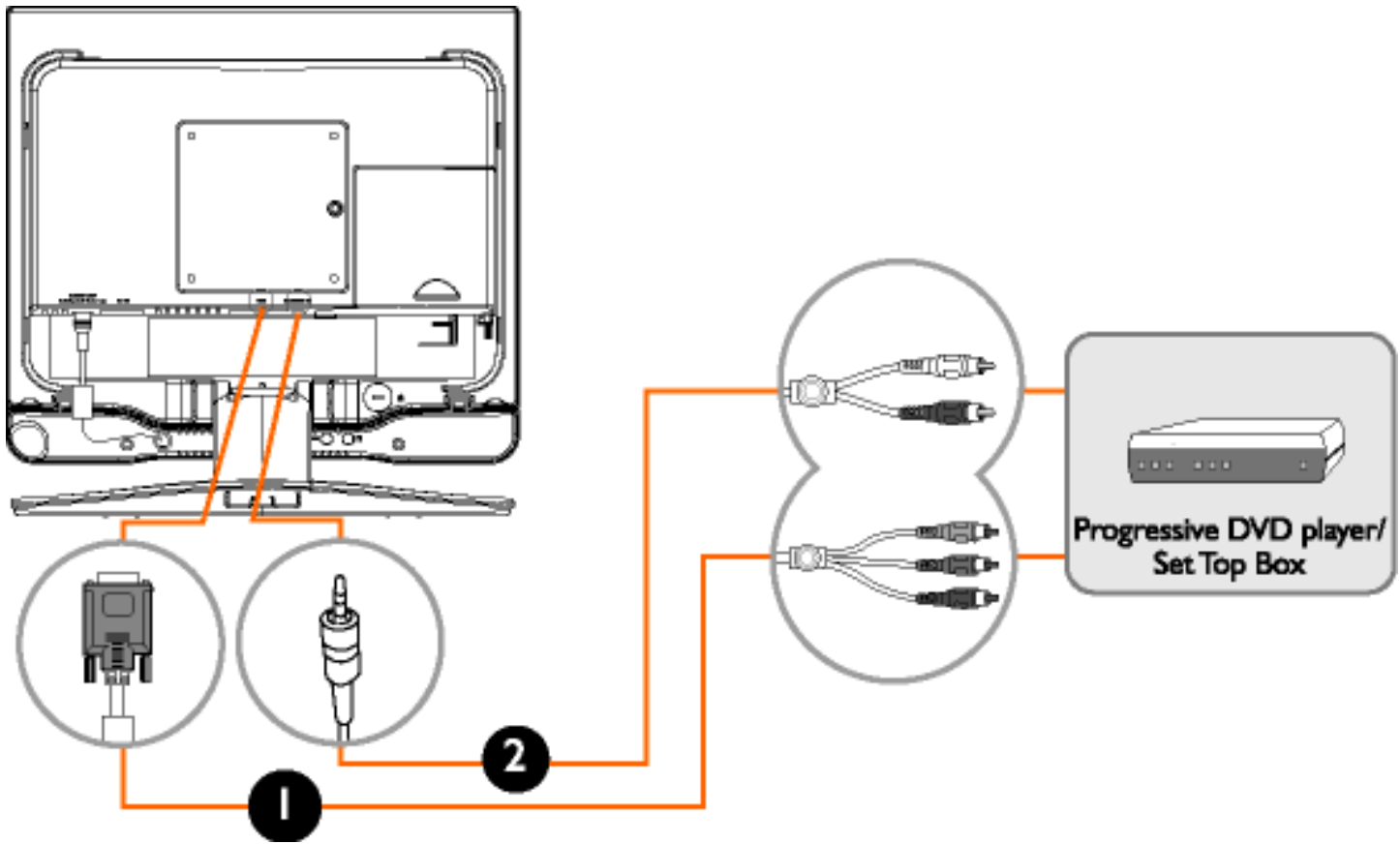

1. Using the supplied YPbPr to VGA adapter cable, connect the YPbPr end to the COMPONENT VIDEO OUT terminal of progressive DVD/Setup Box, and connect the other end to the VGA connector on the back of the monitor.
2. Connect the RCA cable to AUDIO (L) and AUDIO (R) to the corresponding audio out terminals on DVD/Setup Box, and the other end to the AUDIO IN connector on the back of the monitor.

[RETURN TO TOP OF THE PAGE](#)

## D) Connecting to TV/CATV

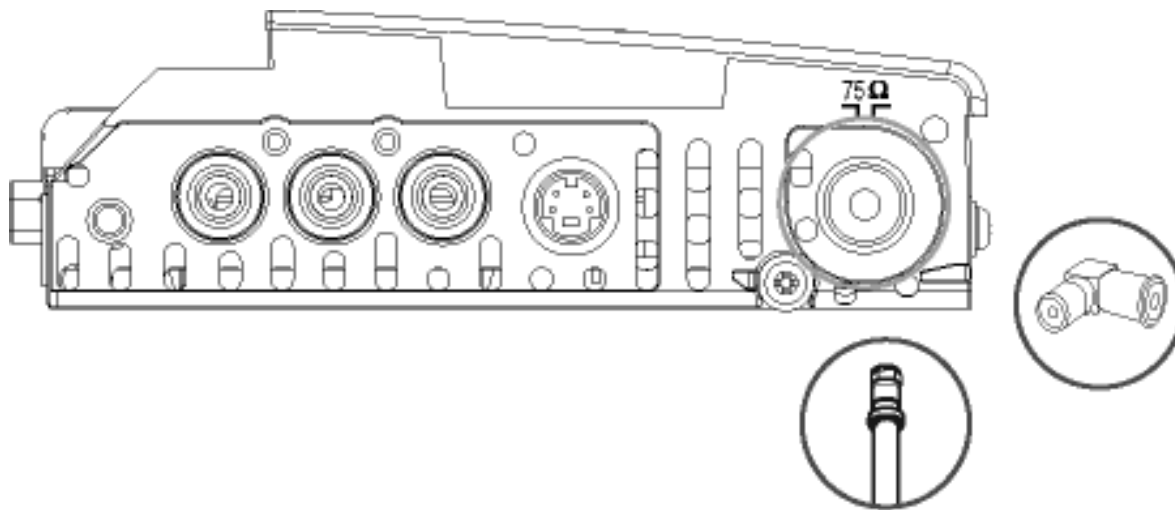

1. Connect an antenna or CATV cable to the antenna port of tuner box.

[RETURN TO TOP OF THE PAGE](#)

---

## Using the Cable Management

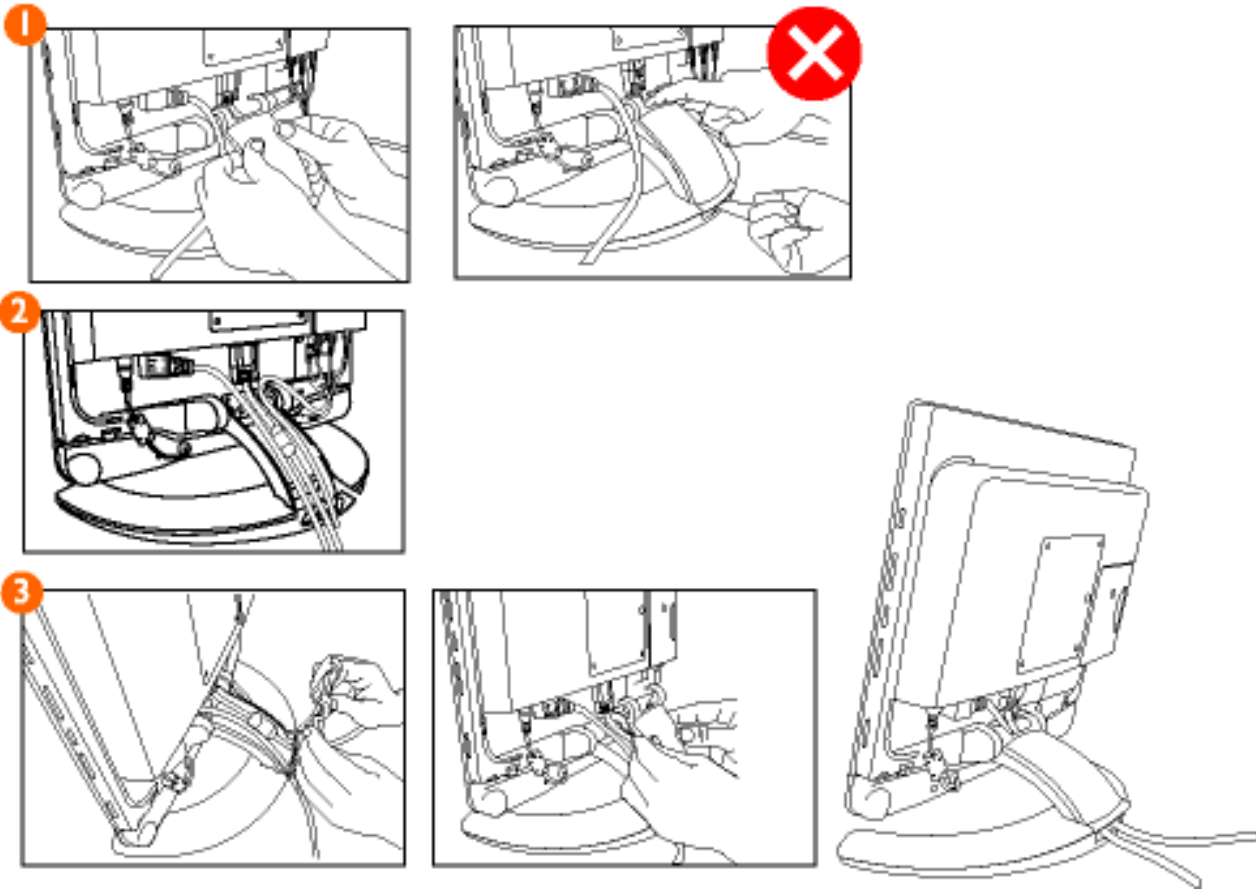

- 1) Remove the arm box's top cover.  
Press the center of the cap and open the cap from sides (Do not attempt to open the cap from the top or the bottom)
- 2) Place the cables inside the arm box.
- 3) Replace top cover.



We recommend you follow intelligent cable management to reduce the electrical alternating field to low level as not to burden the work environment with unnecessary factors.

[RETURN TO TOP OF THE PAGE](#)

---

**To attach and remove back cover**

**To attach back cover**

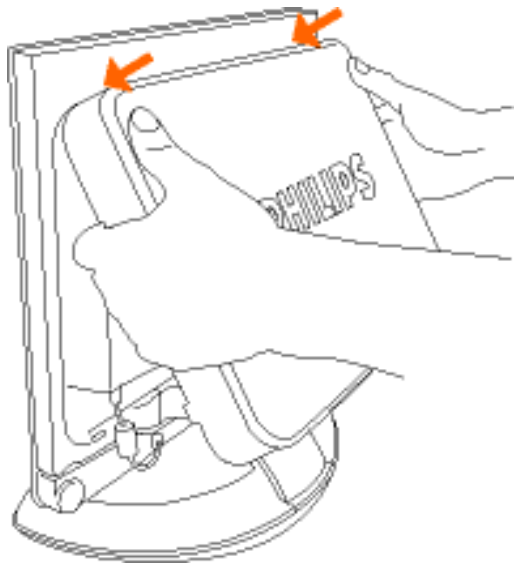

- 1) Line up in ventilation.  
Before attempting to seal the cover, make sure it is properly aligned with the upper hooks.



- 2) Use hands to push and seal in place.

## To remove back cover



1) Lift off the rear cover from the top hooks at an angle of less than 30 degrees to avoid hook damage.

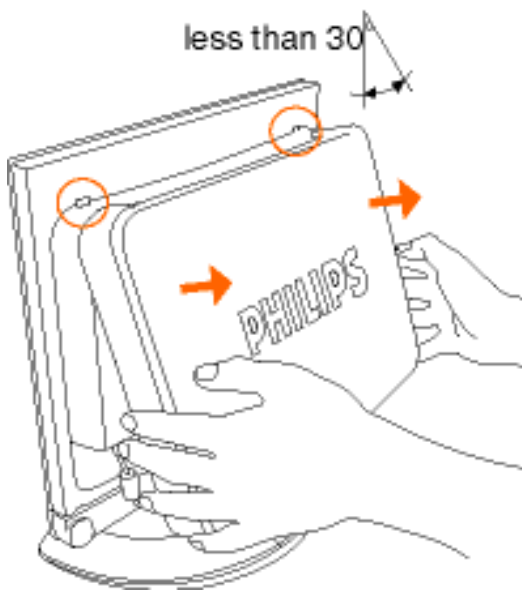

[RETURN TO TOP OF THE PAGE](#)

# VESA Mounting and Easy Wall Mounting

[Front View Product Description](#) • [Accessory Pack](#) • [Connecting to Your PC, TV Antenna, DVD/VCR etc.](#) • [Installing the Optional TV/AV Module](#) • [Getting Started](#) • [Optimising Performance](#)

[Unfold the base](#) • [Fold the base](#) • [Foldable base available for easy wall mounting](#) • [VESA Wall Mounting](#)

---

## Unfold and Fold the Base

### Unfold the Base

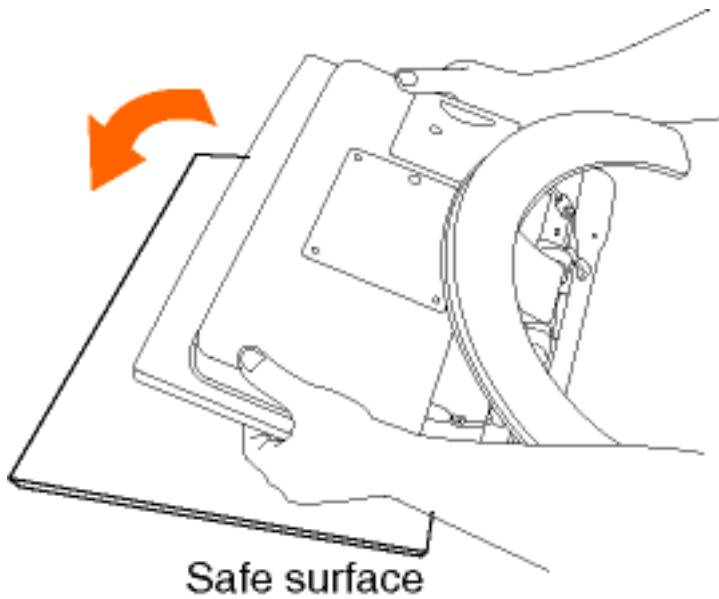

**1)** Place monitor face down on a safe surface

**2)** Pull up the base



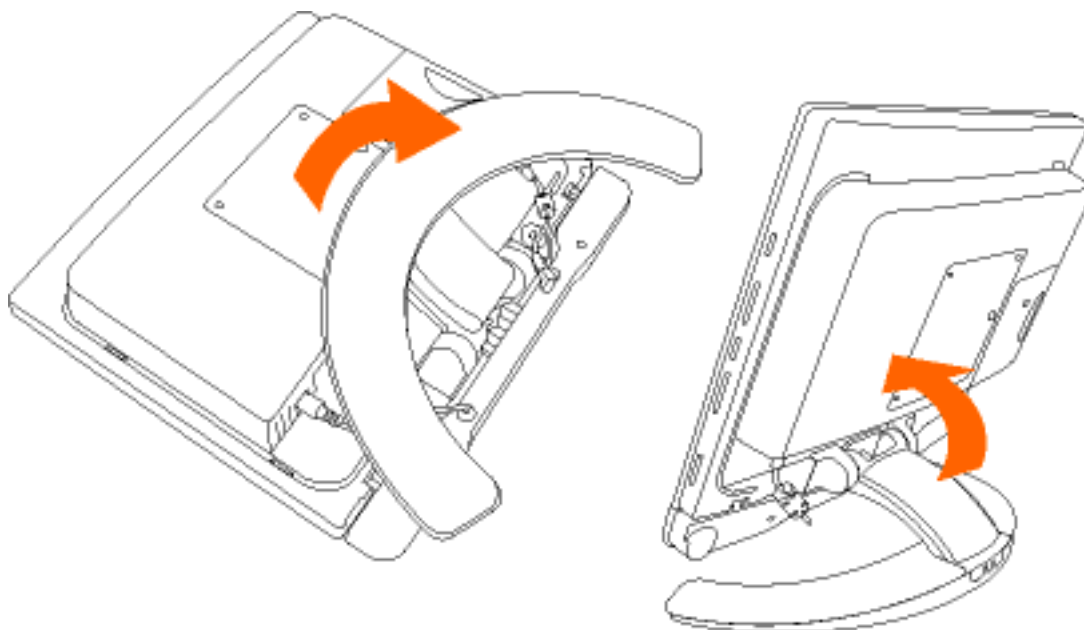

## Fold the Base

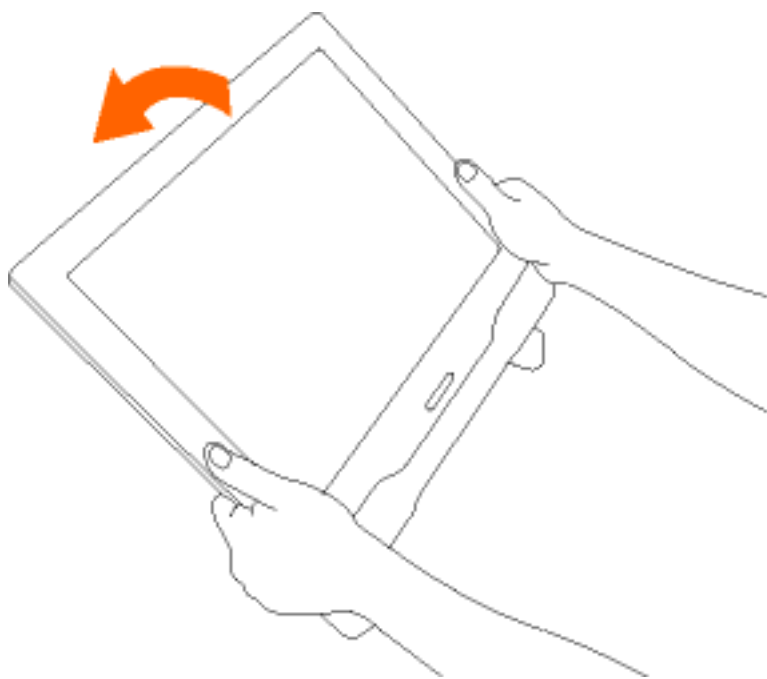

- 1) Push down the head of monitor. Make sure the back cover is removed when folding the base.

## Foldable base available for easy wall mounting

Make sure the back cover is removed before mounting the monitor on the wall.

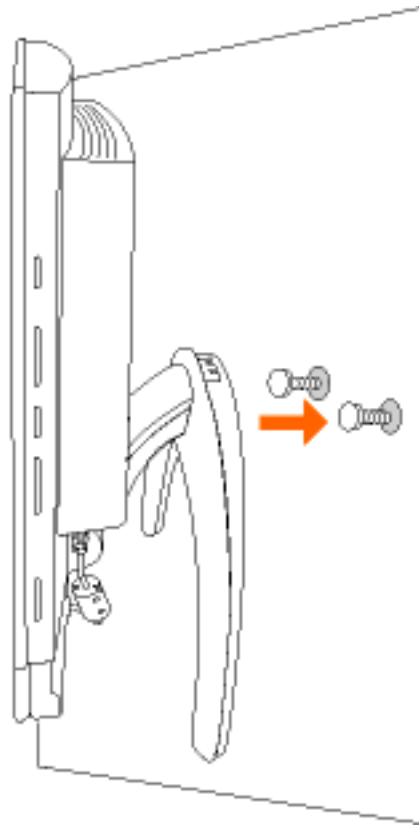
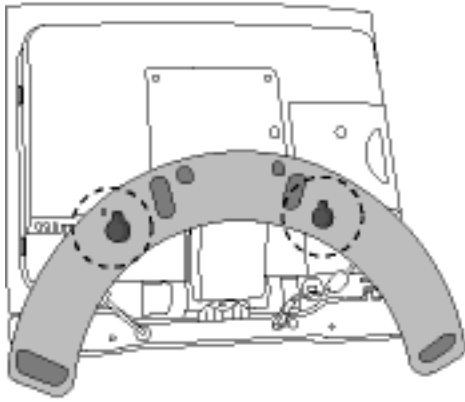

### Smart tips

1. Use the full scale template to mark on the wall the horizontal distance (130 mm) between the two mounting screws.

*Notes:*

- *The surface for mounting area must be flat and larger than the pedestal.*
  - *The wall must support a pull force of 10 kg for each screw.*
2. At the locations marked, drill two holes in the wall, each 7 mm in diameter and 25 mm in depth.
  3. Securely insert the plastic wall anchors (1) and then use the two screws (2) to fasten the mounting pedestal to the wall.



## WARNING!

- Read all instructions carefully before mounting!
- Correct assembly is essential. The maximum allowed weight of the LCD Display is 6.5 kg/14.3 lbs.
- The assembly materials that come with the product are only suitable for attachment to solid wood, brick or concrete walls.
- For wood walls: Discard the wall anchors! Drill each hole 3.6 mm in diameter and 20 mm in depth.
- To avoid possible injury, do not mount above a sofa or bed.

The manufacturer accepts no liability for improper installations or installations not performed in accordance with these instructions.

[RETURN TO TOP OF THE PAGE](#)

---

## VESA Wall Mounting

### A) Remove the base

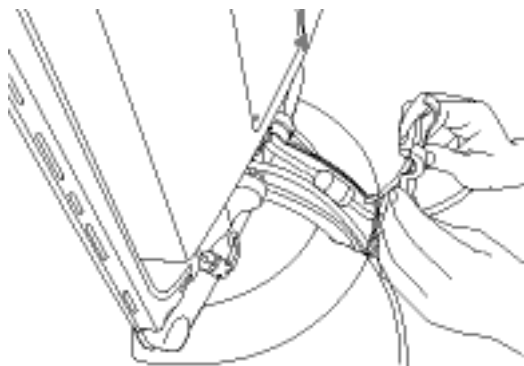

- 1) Remove the arm box's top cover

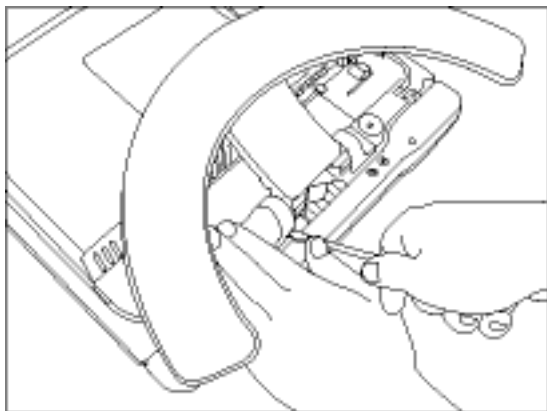

**2)** Remove the hinge cape

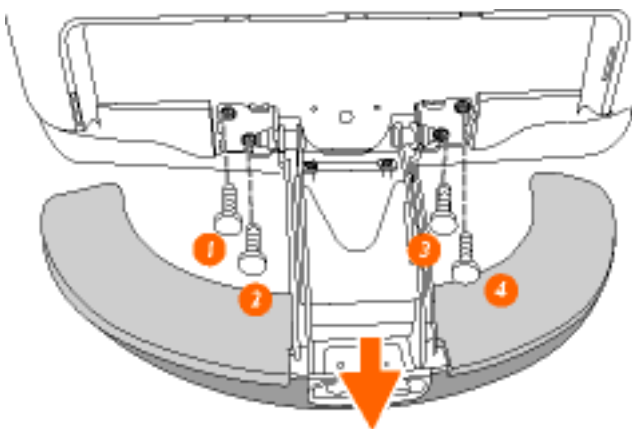

**3)** Remove the 4 screws and then remove the base from the LCD monitor.

**B) Attaching a wall or arm mounting device.**

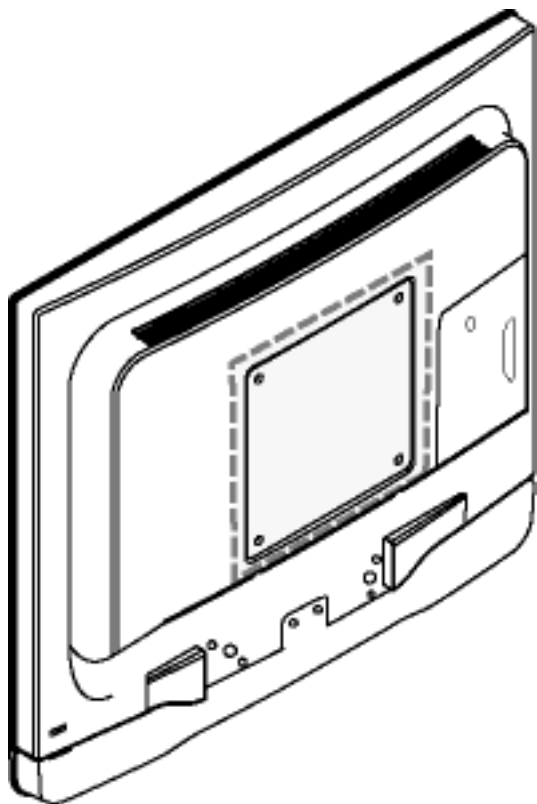

**Note:** This monitor accepts a 100mmx100mm VESA-Compliant mounting interface. The monitor support VESA mounting standard for use with various VESA mounting devices. To install any VESA mounting devices, please follow the instructions given.

[RETURN TO TOP OF THE PAGE](#)

# Installing the Optional TV/AV Module

[Front View Product Description](#) • [Connecting to Your PC, TV Antenna, DVD/VCR etc.](#) • [VESA Mounting and Easy Wall Mounting](#) • [Getting Started](#) • [Optimising Performance](#)

**Optional TV/AV Module:** [Detach the TV dummy cover](#) • [Install the TV module](#)

---

## Detach the TV dummy cover

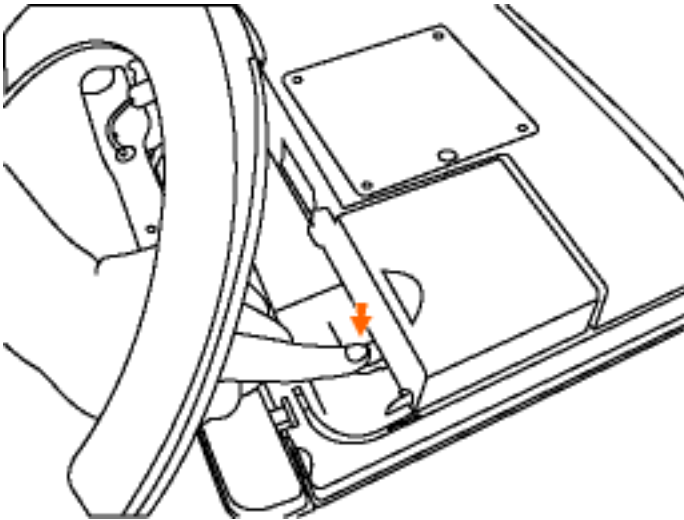

1) Press and hold the TV module release button.

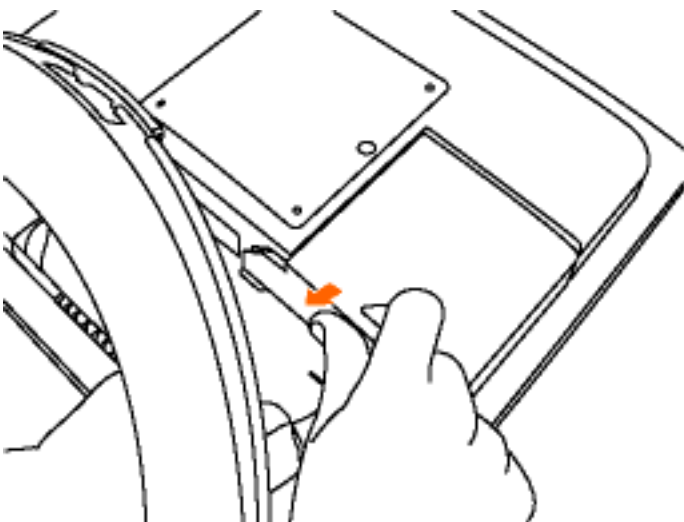

2) Pull the TV module cover down as indicated to release the cover.

[RETURN TO TOP OF THE PAGE](#)

---

## Install the TV module

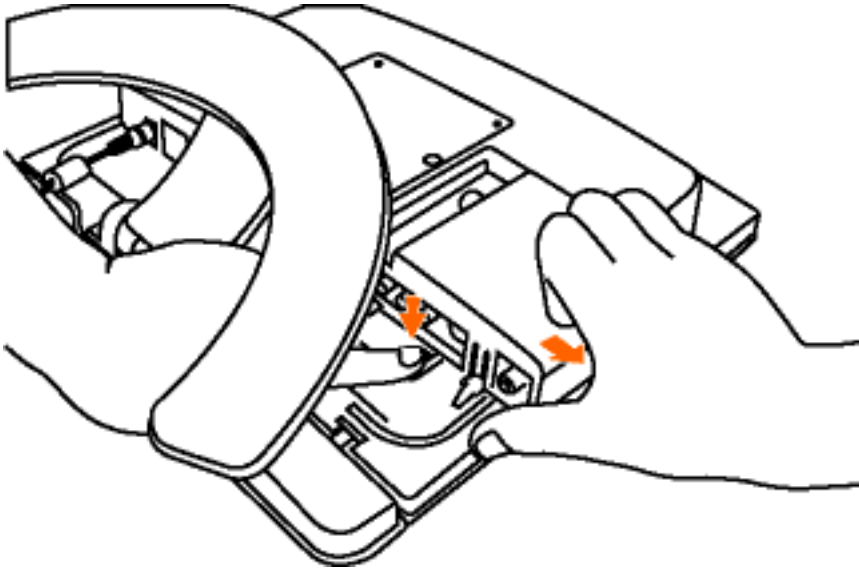

**1)** Press and hold the TV module release button.

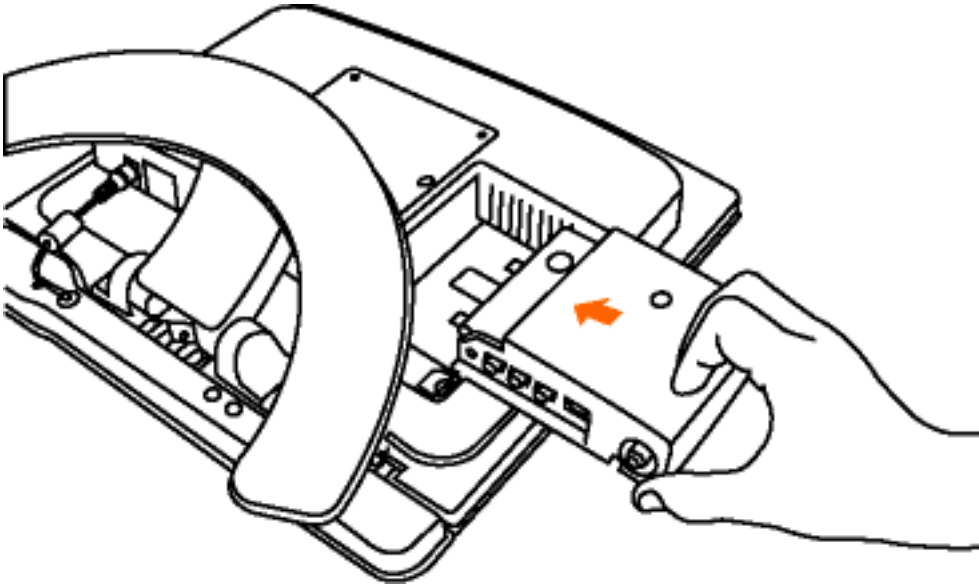

**2)** Slide the TV module towards the center of the monitor until it locks into the monitor.

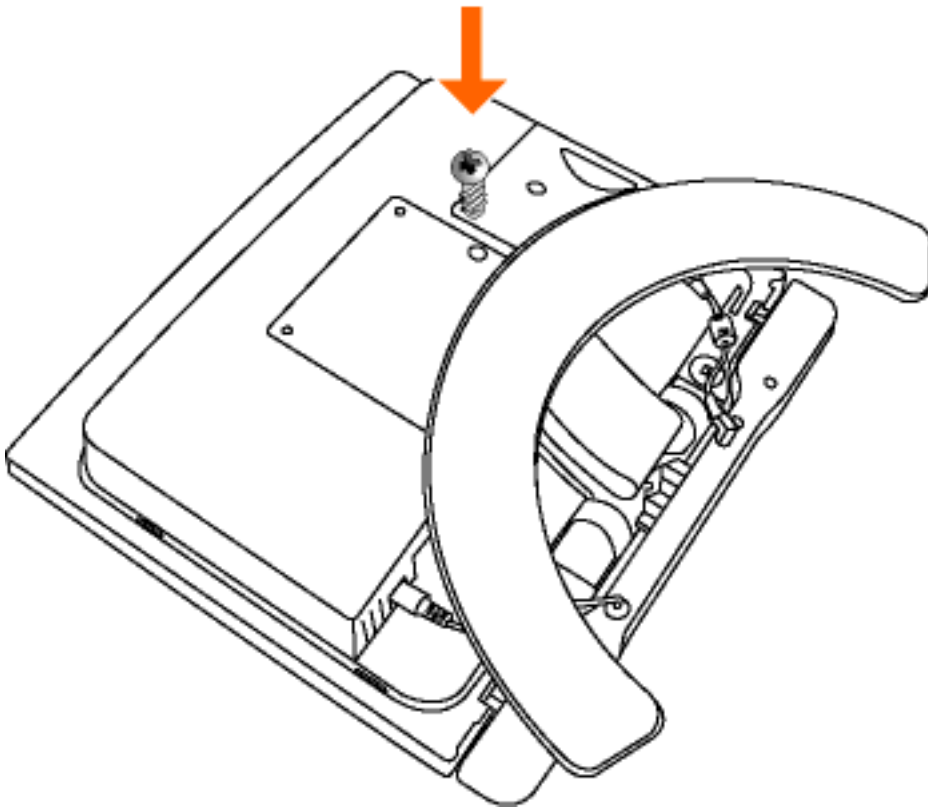

**3)** Please secure the TV module using the security screw provided.

[RETURN TO TOP OF THE PAGE](#)



# Getting Started

[Front View Product Description](#) • [Connecting to Your PC, TV Antenna, DVD/VCR etc.](#) • [VESA Mounting and Easy Wall Mounting](#) • [Installing the Optional TV/AV Module](#) • [Getting Started](#) • [Optimizing Performance](#)

---

## Getting Started

### Use the information file ( .inf) for Windows® 95/98/2000/Me/XP or later

The built-in VESA DDC2B feature in Philips Monitors supports Plug & Play requirements for Windows® 95/98/2000/Me/XP. This information file ( .inf) should be installed in order that your Philips monitor can be enabled from the 'Monitor' dialog box in Windows® 95/98/2000/Me/XP and the Plug & Play application can be activated. The installation procedure based on Windows® '95 OEM Release 2 , 98 , Me, XP and 2000 is specified as follows.

#### For Windows® 95

1. Start Windows® '95
2. Click on the 'Start' button, point to 'Settings', and then click on 'Control Panel'.
3. Double click on the 'Display' Icon.
4. Select the 'Settings' tab then click on 'Advanced...'
5. Select the 'Monitor' button, point to 'Change...' then click on 'Have Disk...'
6. Click on the 'Browse...' button, select the appropriate drive F: ( CD-ROM Drive) then click on the 'OK' button.
7. Click on the 'OK' button then select your monitor model and click on 'OK'.
8. Click on the 'Close' button.

#### For Windows® 98

1. Start Windows® 98
2. Click on the 'Start' button, point to 'Settings', and then click on 'Control Panel'.
3. Double click on the 'Display' Icon.
4. Select the 'Settings' tab then click on 'Advanced...'
5. Select the 'Monitor' button, point to 'Change...' then click on 'Next'
6. Select 'Display a list of all the drivers in a specific location, so you can choose the driver you want.' then click on 'Next' and then click on 'Have Disk...'
7. Click on the 'Browse...' button, select the appropriate drive F: ( CD-ROM Drive) then click on the 'OK' button.
8. Click on the 'OK' button then select your monitor model and click on the 'Next' button.
9. Click on the 'Finish' button then the 'Close' button.

## For Windows® Me

1. Start Windows® Me
2. Click on the 'Start' button, point to 'Settings', and then click on 'Control Panel'.
3. Double click on the 'Display' Icon.
4. Select the 'Settings' tab then click on 'Advanced...'
5. Select the 'Monitor' button, then click on 'Change...' button.
6. Select 'Specify the location of the driver(Advanced)' and click on the 'Next' button.
7. Select 'Display a list of all the drivers in a specific location, so you can choose the driver you want', then click on 'Next' and then click on 'Have Disk...'
8. Click on the 'Browse...' button, select the appropriate drive F: ( CD-ROM Drive) then click on the 'OK' button.
9. Click on the 'OK' button, select your monitor model and click on the 'Next' button.
10. Click on 'Finish' button then the 'Close' button.

## For Windows® 2000

1. Start Windows® 2000
2. Click on the 'Start' button, point to 'Settings', and then click on 'Control Panel'.
3. Double click on the 'Display' Icon.
4. Select the 'Settings' tab then click on 'Advanced...'
5. Select 'Monitor'
  - If the 'Properties' button is inactive, it means your monitor is properly configured. Please stop installation.
  - If the 'Properties' button is active. Click on 'Properties' button. Please follow the steps given below.
6. Click on 'Driver' and then click on 'Update Driver...' then click on the 'Next' button.
7. Select 'Display a list of the known drivers for this device so that I can choose a specific driver', then click on 'Next' and then click on 'Have disk...'
8. Click on the 'Browse...' button then select the appropriate drive F: ( CD-ROM Drive).
9. Click on the 'Open' button, then click on the 'OK' button.
10. Select your monitor model and click on the 'Next' button.
11. Click on the 'Finish' button then the 'Close' button.
  - If you can see the 'Digital Signature Not Found' window, click on the 'Yes' button.

## For Windows® XP

1. Start Windows® XP
2. Click on the 'Start' button and then click on 'Control Panel'.
3. Select and click on the category 'Printers and Other Hardware'
4. Click on the 'Display' Item.
5. Select the 'Settings' tab then click on the 'Advanced' button.
6. Select 'Monitor' tab
  - If the 'Properties' button is inactive, it means your monitor is properly configured. Please stop installation.
  - If the 'Properties' button is active, click on 'Properties' button.  
Please follow the steps below.
7. Click on the 'Driver' tab and then click on 'Update Driver...' button.

8. Select the 'Install from a list or specific location [advanced]' radio button and then click on the 'Next' button.
9. Select the 'Don't Search. I will choose the driver to install' radio button. Then click on the 'Next' button.
10. Click on the 'Have disk...' button, then click on the 'Browse...' button and then select the appropriate drive F: (CD-ROM Drive).
11. Click on the 'Open' button, then click the 'OK' button.
12. Select your monitor model and click on the 'Next' button.
  - If you can see the 'has not passed Windows® Logo testing to verify its compatibility with Windows® XP' message, please click on the 'Continue Anyway' button.
13. Click on the 'Finish' button then the 'Close' button.
14. Click on the 'OK' button and then the 'OK' button again to close the Display\_Properties dialog box.









If your Windows® 95/98/2000/Me/XP version is different or you need more detailed installation information, please refer to Windows® 95/98/2000/Me/XP user's manual.

[RETURN TO TOP OF THE PAGE](#)

# Using Other Menus (Europe Area)

- [Using the Remote Control](#)
  - [Selecting a source input](#)
  - [Adjusting the picture preference](#)
  - [Adjusting the sound preference](#)
  - [Selecting a preferred OSD language](#)
  - [Screen modes](#)
  - [Automatic tuning](#) • [Manual tuning](#) • [Skipping programmes](#)
- 





## Using the Remote Control

1. Press **MENU** to activate the control menu display.
2. Use ,  to scroll the highlighted item to be selected.
3. Use **MENU** to select the item to be changed.
4. Use ,  again to scroll the highlighted sub-item to be selected.
5. Use ,  to adjust the value of selected item. Or use **MENU** to select the desired option.
6. When the setting is correct, use ,  to highlight EXIT item and press **MENU** to exit from the menu. The menu OSD will disappear.
7. The menu will disappear automatically after a few seconds without any key having to be pressed.

[RETURN TO TOP OF THE PAGE](#)

---

## Selecting a source input

1. Press **MENU** to activate the menu.
2. Use ,  to scroll the highlight INPUT SELECT, and then press **MENU**.
3. Use ,  to highlight the input source to be selected. There are five input sources:
  - PC
  - TV
  - AV

- S-video
- HD-YPbPr

4. Press **MENU** to select the input source.

[RETURN TO TOP OF THE PAGE](#)

---

## Adjusting the picture preference



1. Press **MENU** to activate the menu.

2. Use ,  to scroll the highlight PICTURE, and then press **MENU**.

3.

Use ,  to highlight the picture parameter to be adjusted. There are 5 parameters:

- BRIGHTNESS: adjusts screen brightness.
- CONTRAST: alters the variation between light and dark tones.
- COLOUR: alters the colour darkness.
- SHARPNESS: alters the crispness of the image.
- COLOUR TEMP (colour temperature): adjusts the colour temperature of the picture. Three options are available here:  
COOL (blue white), NORMAL (balanced) or WARM (red white).

4. Press ,  to adjust BRIGHTNESS, CONTRAST, COLOUR, SHARPNESS. Or, press **MENU** to further change COLOUR TEMP setting.

5. Use ,  to highlight EXIT and then press **MENU** to exit from the menu.

[RETURN TO TOP OF THE PAGE](#)

---

## Adjusting the sound preference

1. Press **MENU** to activate the menu.

2. Use ,  to scroll the highlight SOUND, and then press **MENU**.

3. Use ,  to highlight the sound parameter to be adjusted. There are 4 parameters:

- TREBLE: alters the level of the high frequency sound.
- BASS: alters the level of the low frequency sound.
- BALANCE: to balance the sound between the left and right speakers.

- **SURROUND ON/OFF**: to turn the surrounding sound effect on or off.
4. Press **◀**, **▶** to adjust the selected parameter.
  5. Use **◀**, **▶** to highlight **EXIT** and then press **MENU** to exit from the menu.

[RETURN TO TOP OF THE PAGE](#)

---

## Selecting a preferred OSD language

1. Press **MENU** to activate the menu.
2. Use **◀**, **▶** to scroll the highlight **LANGUAGE**, and then press **MENU**.
3. Use **◀**, **▶** to highlight the language to be selected. There are 5 languages:
  - **ENGLISH**
  - **ESPAÑOL**
  - **FRANÇAIS**
  - **DEUTSCH**
  - **ITALIANO**
4. Press **MENU** to select the language.
5. Use **◀**, **▶** to highlight **EXIT** and then press **MENU** to exit from the menu.

[RETURN TO TOP OF THE PAGE](#)

---

## Screen modes

This menu allows you to set your screen display mode to match the input video aspect ratio.

1. Press **MENU** to activate the menu.
2. Use **◀**, **▶** to scroll the highlight **VIDEO MODE**, and then press **MENU** to activate the video mode menu.
3. Press **◀**, **▶** keys to highlight one mode:
  - **REGULAR** for 4:3 programme
  - **WIDE** for 16:9 programme in letter box display. Upper and bottom will have obvious black stripe

4. Press **MENU** to select the mode.
5. Use **0**, **0** to highlight EXIT and then press **MENU** to exit from the menu.

[RETURN TO TOP OF THE PAGE](#)

---

## Automatic tuning

This menu allows you to automatically search for all the programmes available in your region (or on your cable network).

1. Press **MENU** to activate the menu.
2. Use **0**, **0** to scroll the highlight INSTALL, and then press **MENU**.
3. Use **0**, **0** to scroll the highlight SYSTEM, and then press **MENU**.
4. Press **0**, **0** keys to select your region. There are two choices:
  - WEST EUR
  - FRANCE
5. Press **MENU** to return the install menu.
6. Use **0**, **0** to scroll the highlight AUTO STORE, and then press **MENU** to activate the automatic searching. After several minutes, the INSTALL menu reappears automatically.
7. The programmes found will be numbered in descending order, starting with 0, 1, 2, etc. Use the SKIP menu to enable or disable the programmes which you want to be skipped. When you use P UP/DOWN to access a programme, all disabled programmes will be skipped.







[RETURN TO TOP OF THE PAGE](#)

---

## Manual tuning

This menu allows you to store the programmes one by one by hand.

1. Press **MENU** to activate the menu.
2. Use **0**, **0** to scroll the highlight INSTALL, and then press **MENU**.
3. Use **0**, **0** to scroll the highlight MANUAL STORE, and then press **MENU**.







4. Use ,  to scroll the highlight SEARCH and press **MENU**. The search begins. As soon as a programme is found, the search will stop. If you know the frequency of the programme required, enter its number directly using the 0-9 keys and go to step 6.
5. If reception is unsatisfactory, select FINE TUNE and hold down  or  key.
6. Select PROG. NO (programme number) and use the  or  to change the desired number.
7. Select STORE and press **MENU**. The message STORED appears. The programme is stored.
8. Repeat steps 4 to 7 for each programme to be stored.

[RETURN TO TOP OF THE PAGE](#)

---

## Skipping programmes

This menu allows you to set the skipped programmes when you use p +/- keys to access the programme.

1. Press **MENU** to activate the menu.
2. Use ,  to scroll the highlight INSTALL, and then press **MENU**.
3. Use ,  to scroll the highlight CHANNEL SKIP, and then press **MENU**.
4. Use [P UP] or [P DN] keys to view the programme in the list.
5. Select the programme you wish to skip or not skip using  or  keys. The skip function will be toggled on or off.









[RETURN TO TOP OF THE PAGE](#)



# Using Other Menus (Asia Pacific Area and China excluding Korea, Taiwan, and Philippines)

- [Using the Remote Control](#)
  - [Selecting a source input](#)
  - [Adjusting the picture preference](#)
  - [Adjusting the sound preference](#)
  - [Selecting a preferred OSD language](#)
  - [Video mode](#)
  - [Automatic tuning](#) • [Manual tuning](#) • [Skipping programmes](#)
- 





## Using the Remote Control

1. Press **MENU** to activate the control menu display.
2. Use ,  to scroll the highlighted item to be selected.
3. Use **MENU** to select the item to be changed.
4. Use ,  again to scroll the highlighted sub-item to be selected.
5. Use ,  to adjust the value of selected item. Or use **MENU** to select the desired option.
6. When the setting is fine, use ,  to highlight EXIT item and press **MENU** to exit from the menu. The menu OSD will disappear.
7. Menu will disappear automatically after few seconds while no key was pressed.

[RETURN TO TOP OF THE PAGE](#)

---

## Selecting a source input

1. Press **MENU** to activate the menu.
2. Use ,  to scroll the highlight INPUT SELECT, and then press **MENU**.
3. Use ,  to highlight the input source to be selected. There are 5 input sources:
  - PC
  - TV
  - AV

- S-video
- HD-YPbPr

4. Press **MENU** to select the input source.

[RETURN TO TOP OF THE PAGE](#)

---

## Adjusting the picture preference



1. Press **MENU** to activate the menu.

2. Use ,  to scroll the highlight PICTURE, and then press **MENU**.

3.

Use ,  to highlight the picture parameter to be adjusted. There are 6 parameters:

- BRIGHTNESS: alters the brightness of the image.
- CONTRAST: alters the variation between light and dark tones.
- COLOUR: alters the colour intensity.
- SHARPNESS: alters the crispness of the image.
- TINT: Adjusts tint.
- COLOUR TEMP (colour temperature): adjusts the colour temperature of the picture. Three options are available here:  
COOL (blue white), NORMAL (balanced) or WARM (red white).

4. Press ,  to adjust BRIGHTNESS, CONTRAST, COLOUR, SHARPNESS. Or, press **MENU** to further change COLOUR TEMP setting.



5. Use ,  to highlight EXIT and then press **MENU** to exit from the menu.



[RETURN TO TOP OF THE PAGE](#)

---

## Adjusting the sound preference

1. Press **MENU** to activate the menu.

2. Use ,  to scroll the highlight SOUND, and then press **MENU**.

3. Use ,  to highlight the sound parameter to be adjusted. There are 4 parameters:

- TREBLE: alters the level of the high frequency sound.
- BASS: alters the level of the low frequency sound.

- **BALANCE**: to balance the sound between the left and right speakers.
  - **SURROUND ON/OFF**: to turn the surrounding sound effect on or off.
4. Press **◀**, **▶** to adjust the selected parameter.
  5. Use **◀**, **▶** to highlight **EXIT** and then press **MENU** to exit from the menu.

[RETURN TO TOP OF THE PAGE](#)

---

## Selecting a preferred OSD language

1. Press **MENU** to activate the menu.
2. Use **◀**, **▶** to scroll the highlight **LANGUAGE**, and then press **MENU**.
3. Use **◀**, **▶** to highlight the language to be selected. There are two languages:
  - **ENGLISH**
  - **中文**
4. Press **MENU** to select the language.
5. Use **◀**, **▶** to highlight **EXIT** and then press **MENU** to exit from the menu.

[RETURN TO TOP OF THE PAGE](#)

---

## Video Mode

This menu allows you to set your screen display mode to match the input video aspect ratio.

1. Press **MENU** to activate the menu.
2. Use **◀**, **▶** to scroll the highlight **VIDEO MODE**, and then press **MENU** to activate the video mode menu.
3. Press **◀**, **▶** keys to highlight mode:
  - **REGULAR** for 4:3 programme
  - **WIDE** for 16:9 programme in letter box display  
*Upper and bottom will have obvious black stripe*
4. Press **MENU** to select the mode.

5. Use **0** , **0** to highlight EXIT and then press **MENU** to exit from the menu.

[RETURN TO TOP OF THE PAGE](#)

---

## Automatic tuning

This menu allows you to automatically search for all the programmes available in your region (or on your cable network).

1. Press **MENU** to activate the menu.
2. Use **0** , **0** to scroll the highlight INSTALL, and then press **MENU**.
3. Use **0** , **0** to scroll the highlight AUTO STORE, and then press **MENU** to activate the automatic searching. After several minutes, the INSTALL menu reappears automatically.
4. The programmes found will be numbered in ascending order starting at 0, 1, 2, etc. Use the SKIP menu to enable or disable the programmes which you want it to be skipped. When you use P UP/DOWN to access programme, all disable programmes will be skipped.

[RETURN TO TOP OF THE PAGE](#)

---

## Manual tuning

This menu allows you to store the programmes one by one by hand.

1. Press **MENU** to activate the menu.
2. Use **0** , **0** to scroll the highlight INSTALL, and then press **MENU**.
3. Use **0** , **0** to scroll the highlight MANUAL STORE, and then press **MENU**.
4. Use **0** , **0** to scroll the highlight SEARCH and press **MENU**. The search begins. As soon as a programme is found, the search will stop. If you know the frequency of the programme required, enter its number directly using the 0, 9 keys and go to step 6.
5. If reception is unsatisfactory, select FINE TUNE and hold down **0** or **0** key.
6. Select PROG. NO (programme number) and use the **0** or **0** to change the desired number.
7. Select STORE and press **MENU**. The message STORED appears. The programme is stored.







8. Repeat steps 4 to 7 for each programme to be stored.

[RETURN TO TOP OF THE PAGE](#)

---

## Skipping programmes

This menu allows you to set the skipped programmes when you use p +/- keys to access the programme.









1. Press **MENU** to activate the menu.
2. Use ,  to scroll the highlight INSTALL, and then press **MENU**.
3. Use ,  to scroll the highlight CHANNEL SKIP, and then press **MENU**.
4. Use [P UP] or [P DN] keys to view the programme in the list.
5. Select the programme you wish to skip or not skip using  or  keys. The skip function will be toggled on or off.

[RETURN TO TOP OF THE PAGE](#)

# Using Other Menus (Americas, Korea, Taiwan and Philippines)

- [Using the Remote Control](#)
  - [Selecting a source input](#)
  - [Adjusting the picture preference](#)
  - [Adjusting the sound preference](#)
  - [Selecting a preferred OSD language](#)
  - [Video mode](#)
  - Install: [Automatic tuning](#) • [Manual tuning](#) • [Skipping programmes](#)
- 





## Using the Remote Control

1. Press **MENU** to activate the control menu display.
2. Use ,  to scroll the highlighted item to be selected.
3. Use **MENU** to select the item to be changed.
4. Use ,  again to scroll the highlighted sub-item to be selected.
5. Use ,  to adjust the value of selected item. Or use **MENU** to select the desired option.
6. When the setting is fine, use ,  to highlight EXIT item and press **MENU** to exit from the menu. The menu OSD will disappear.
7. Menu will disappear automatically after few seconds while no key was pressed.

[RETURN TO TOP OF THE PAGE](#)

---

## Selecting a source input

1. Press **MENU** to activate the menu.
2. Use ,  to scroll the highlight INPUT SELECT, and then press **MENU**.
3. Use ,  to highlight the input source to be selected. There are 5 input sources:
  - PC
  - TV
  - AV

- S-Video
- HD-YPbPr

4. Press **MENU** to select the input source.

[RETURN TO TOP OF THE PAGE](#)

---

## Adjusting the picture preference



1. Press **MENU** to activate the menu.

2. Use ,  to scroll the highlight PICTURE, and then press **MENU**.

3.

Use ,  to highlight the picture parameter to be adjusted. There are 6 parameters:

- BRIGHTNESS: alters the brightness of the image.
- CONTRAST: alters the variation between light and dark tones.
- COLOUR: alters the colour intensity.
- TINT: Adjusts tint.
- SHARPNESS: alters the crispness of the image.
- COLOUR TEMP (colour temperature): adjusts the colour temperature of the picture. Three options are available here:  
COOL (blue white), NORMAL (balanced) or WARM (red white).

4. Press ,  to adjust BRIGHTNESS, CONTRAST, COLOUR, SHARPNESS. Or, press **MENU** to further change COLOUR TEMP setting.

5. Use ,  to highlight EXIT and then press **MENU** to exit from the menu.



[RETURN TO TOP OF THE PAGE](#)

---





## Adjusting the sound preference

1. Press **MENU** to activate the menu.

2. Use ,  to scroll the highlight SOUND, and then press **MENU**.

3. Use ,  to highlight the sound parameter to be adjusted. There are 4 parameters:







- TREBLE: alters the level of the high frequency sound.
- BASS: alters the level of the low frequency sound.

- **BALANCE**: to balance the sound between the left and right speakers.
  - **SURROUND ON/OFF**: to turn the surrounding sound effect on or off.
4. Press ,  to adjust the selected parameter.
  5. Use ,  to highlight EXIT and then press **MENU** to exit from the menu.

[RETURN TO TOP OF THE PAGE](#)

---

## Selecting a preferred OSD language





1. Press **MENU** to activate the menu.
2. Use ,  to scroll the highlight LANGUAGE, and then press **MENU**.
3. Use ,  to highlight the language to be selected. There are 4 languages:
  - **ENGLISH**
  - **ESPAÑOL**
  - **FRANÇAIS**
  - **中文**
4. Press **MENU** to select the language.
5. Use ,  to highlight EXIT and then press **MENU** to exit from the menu.

[RETURN TO TOP OF THE PAGE](#)



---

## Video Mode

This menu allows you to set your screen display mode to match the input video aspect ratio.

1. Press **MENU** to activate the menu.
2. Use ,  to scroll the highlight VIDEO MODE, and then press **MENU** to activate the video mode menu.
3. Press ,  keys to highlight one mode:
  - **REGULAR** for 4:3 programme
  - **WIDE** for 16:9 programme in letter box display  
*Upper and bottom will have obvious black stripe*











4. Press **MENU** to select the mode.
5. Use ,  to highlight EXIT and then press **MENU** to exit from the menu.

[RETURN TO TOP OF THE PAGE](#)

---

## Automatic tuning

This menu allows you to automatically search for all the programmes available in your region (or on your cable network).







1. Press **MENU** to activate the menu.
2. Use ,  to scroll the highlight INSTALL, and then press **MENU**.
3. Use ,  to scroll the highlight TUNER MODE, and then press **MENU**.
4. Press ,  keys to select your tuner:
  - Antenna: your TV is connected to an antenna to receive air programmes
  - Cable: your TV is connected to a cable network
5. Press **MENU** to return the install menu.
6. Use ,  to scroll the highlight AUTO STORE.
7. Press **MENU** to activate the automatic searching. After several minutes, the INSTALL menu reappears automatically.
8. The programmes found will be stored into memory list. Use the SKIP menu to enable or disable the programmes which you want it to be skipped. When you use P UP/DOWN to access programme, all disable programmes will be skipped.

[RETURN TO TOP OF THE PAGE](#)

---

## Manual tuning (Fine tune)

This menu allows you to store the programmes one by one by hand.











1. Press **MENU** to activate the menu.
2. Use ,  to scroll the highlight INSTALL, and then press **MENU**.
3. Use ,  to scroll the highlight FINE TUNE, and then press **MENU**.
4. Press  or  key until get good picture.

[RETURN TO TOP OF THE PAGE](#)

---

## Skipping programmes (Channel edit)

This menu allows you to set the skipped programmes when you use p +/- keys to access the programme.

1. Press **MENU** to activate the menu.
2. Use ,  to scroll the highlight INSTALL, and then press **MENU**.
3. Use ,  to scroll the highlight CHANNEL EDIT.
4. Use ,  keys to view the programme in the list.
5. Toggle skip or not skip using  or  keys.
6. Use ,  to highlight EXIT and then press **MENU** to exit from the menu.

[RETURN TO TOP OF THE PAGE](#)

## Your Philips F1rst Choice Warranty

**Thank you for purchasing this Philips monitor.**



All Philips monitors are designed and manufactured to high standards and deliver high-quality performance, ease of use and ease of installation. Should you encounter any difficulties while installing or using this product, please contact the Philips helpdesk directly to benefit from your Philips F1rst Choice Warranty. This three-year service warranty entitles you to a swap model on-site if your monitor turns out to be faulty or defective. Philips aims at a swap within 48 hours of your call being received.

### What is covered?

The Philips F1rst Choice Warranty applies within Andorra, Austria, Belgium, Cyprus, Denmark, France, Germany, Greece, Finland, Ireland, Italy, Liechtenstein, Luxembourg, Monaco, the Netherlands, Norway, Portugal, Sweden, Switzerland, Spain and the United Kingdom and only for monitors originally designed, manufactured, approved and/or authorized for usage within these countries.

Warranty coverage begins as from the day you buy your monitor. *For three years thereafter*, your monitor will be swapped by at least an equivalent monitor in case of defects provided for under the warranty coverage.

The swap monitor remains yours and Philips keeps the defective/original monitor. For the swap monitor the warranty period remains equal to that of your original monitor, being 36 months as from the purchase date of your original monitor.

### What is excluded?

The Philips F1rst Choice Warranty applies provided the product is handled properly for its intended use, in accordance with its operating instructions and upon presentation of the original invoice or cash receipt, indicating the date of purchase, dealer's name and model and production number of the product.

The Philips F1rst Choice Warranty may not apply if:

- The documents have been altered in any way or made illegible;
- The model or production number on the product has been altered, deleted, removed or made illegible;
- Repairs or product modifications and alterations have been executed by unauthorized service organizations or persons;
- Damage is caused by accidents including but not limited to lightning, water or fire, misuse or neglect;
- Reception problems caused by signal conditions or cable or antenna systems outside the unit;
- Defects caused by abuse or misuse of the monitor;
- Product requires modification or adaptation to enable it to comply with local or national technical

standards, which apply in countries for which the product was not originally designed, manufactured, approved and/or authorized. Therefore always check whether a product can be used in a specific country.

- Note that products that are not originally designed, manufactured, approved and/or authorized for usage within the Philips F1rst Choice countries, do not apply to the Philips F1rst Choice Warranty. In these cases the Philips global warranty terms are valid.

### Just a phone call away

In order to avoid unnecessary inconvenience, we advise you to read the operating instructions carefully before contacting the Philips helpdesk.

To solve your problem quickly, please prepare the following details before contacting the Philips helpdesk:

- Philips type number
- Philips serial number
- Purchase date (copy of purchase may be required)
- PC environment Processor:
  - 286/386/486/Pentium Pro/Internal memory
  - Operating system (Windows, DOS, OS/2, MAC)
  - Fax/Modem/Internet program?
- Other cards installed

Having the following information available will also help speed up the process:

- Your proof of purchase indicating: date of purchase, dealer name, model and product serial number.
- The full address to which the faulty monitor has to be collected and the swap model should be delivered.

Philips' customer help desks are located worldwide. You can contact Philips Monday - Friday from 08.00 - 20.00 hrs Central European Time (CET) and on Saturdays and Sundays from 10.00 to 18.00 hrs CET by using one of the helpdesk telephone numbers. Click here to access the [F1rst Choice Contact Information](#).

Or you can reach us via:

Website: <http://www.philips.com>

# Your International Guarantee

Dear Customer,

Thank you for purchasing this Philips product which has been designed and manufactured to the highest quality standards.

If, unfortunately, something should go wrong with this product Philips guarantees free of charge labor and replacement parts irrespective of the country where it is repaired during a period of 12 months from date of purchase. This international Philips guarantee complements the existing national guarantee obligations to you of dealers and Philips in the country of purchase and does not affect your statutory rights as a customer.

The Philips guarantee applies provided the product is handled properly for its intended use, in accordance with its operating instructions and upon presentation of the original invoice or cash receipt, indicating the date of purchase, dealer's name and model and production number of the product.

The Philips guarantee may not apply if:

- the documents have been altered in any way or made illegible;
- the model or production number on the product has been altered, deleted, removed or made illegible;
- repairs or product modifications and alterations have been executed by unauthorized service organizations or persons;
- damage is caused by accidents including but not limited to lightning, water or fire, misuse or neglect.

Please note that the product is not defective under this guarantee in the case where modifications become necessary in order for the product to comply with local or national technical standards which apply in countries for which the product was not originally designed and/or manufactured. Therefore always check whether a product can be used in a specific country.

In case your Philips product is not working correctly or is defective, please contact your Philips dealer. In the event you require service whilst in another country a dealer address can be given to you by the Philips Consumer Help Desk in that country, the telephone and fax number of which can be found in the relevant part of this booklet.

In order to avoid unnecessary inconvenience, we advise you to read the operating instructions carefully before contacting your dealer. If you have questions which your dealer cannot answer or any related question please contact the [Philips Consumer Information Centers](#) or via:

Website: <http://www.philips.com>

# LIMITED WARRANTY (Computer Monitor)

Click here to access the [Warranty Registration Card](#).

**Three Years Free Labor / Three Years Free Service on Parts / One Year Exchange\***

*\*Product will be exchanged with a new or renewed to original specifications unit within two business days for the first year. This product must be shipped in at your expense for service during years two and three.*

## WHO IS COVERED?

You must have proof of purchase to receive warranty service. A sales receipt or other document showing that you purchased the product is considered proof of purchase. Attach it to this owner's manual and keep both nearby.

## WHAT IS COVERED?

Warranty coverage begins the day you buy your product. *For three years thereafter*, all parts will be repaired or replaced, and labor is free. *After three years from the day of purchase*, you pay for the replacement or repair of all parts, and for all labor charges.

All parts, including repaired and replaced parts, are covered only for the original warranty period. When the warranty on the original product expires, the warranty on all replaced and repaired products and parts also expires.

## WHAT IS EXCLUDED?

Your warranty does not cover:

- labor charges for installation or setup of the product, adjustment of customer controls on the product, and installation or repair of antenna systems outside of the product.
- product repair and/or part replacement because of misuse, accident, unauthorized repair or other cause not within the control of Philips Consumer Electronics.
- reception problems caused by signal conditions or cable or antenna systems outside the unit.
- a product that requires modification or adaptation to enable it to operate in any country other than the country for which it was designed, manufactured, approved and/or authorized, or repair of products damaged by these modifications.
- incidental or consequential damages resulting from the product. (Some states do not allow the

exclusion of incidental or consequential damages, so the above exclusion may not apply to you.

This includes, but is not limited to, prerecorded material, whether copyrighted or not copyrighted.)

- a product used for commercial or institutional purposes.

## **Where IS SERVICE AVAILABLE?**

Warranty service is available in all countries where the product is officially distributed by Philips Consumer Electronics. In countries where Philips Consumer Electronics does not distribute the product, the local Philips service organization will attempt to provide service (although there may be a delay if the appropriate spare parts and technical manual(s) are not readily available).

## **Where CAN I GET MORE INFORMATION?**

For more information, contact the Philips Customer Care Center by calling [\(877\) 835-1838 \(U.S.A. customers only\)](tel:877-835-1838) or [\(402\) 536-4171](tel:402-536-4171).

### ***Before Requesting Service...***

Please check your owner's manual before requesting service. Adjustments of the controls discussed there may save you a service call.

## **TO GET WARRANTY SERVICE IN U.S.A., PUERTO RICO OR U.S. VIRGIN ISLANDS...**

Contact the Philips Customer Care Center phone number listed below for product assistance and procedures for servicing:

*Philips Customer Care Center*

*(877) 835-1838 or (402) 536-4171*

*(In U.S.A., Puerto Rico and U.S. Virgin Islands, all implied warranties, including implied warranties of merchantability and fitness for a particular purpose, are limited in duration to the duration of this express warranty. But, because some states do not allow limitations on how long an implied warranty may last, this limitation may not apply to you.)*

## **TO GET WARRANTY SERVICE IN CANADA...**

Please contact Philips at:

[\(800\) 479-6696](tel:8004796696)

Three years free parts and three years free labor will be provided at Philips Canada depot or any one of its authorized service centers.

(In Canada, this warranty is given in lieu of all other warranties. No other warranties are expressed or implied, including any implied warranties of merchantability or fitness for a particular purpose. Philips is not liable under any circumstances for any direct, indirect, special, incidental or consequential damages, howsoever incurred, even if notified of the possibility of such damages.)

**REMEMBER...** Please record the model and serial numbers found on the product below.

MODEL # \_\_\_\_\_

SERIAL # \_\_\_\_\_

*This warranty gives you specific legal rights. You may have other rights which vary from state/province to state/province.*

Philips Customer Care Center, P. O. Box 2976, Longview, TX 75601, USA



# Philips Warranty Helpdesk

## Telephone numbers:

Austria	01 546 575 603	Luxembourg	026 84 3000
Belgium	02 275 0701	Netherlands	053 482 9800
Cyprus (Greek)	800 92256	Norway	22 70 82 50
Denmark	35 25 87 61	Portugal	0800 831 363
France	03 8717 0033	Sweden	08 632 0016
Germany	0696 698 4712	Switzerland	02 23 10 21 16
Greece	00800 3122 1223	Spain	09 17 45 62 46
Finland	09 2290 1908	United Kingdom	0207 949 0069
Ireland	01 601 1161		
Italy	02 48 27 11 53		

# Consumer Information Centers

[Antilles](#) • [Argentina](#) • [Australia](#) • [Bangladesh](#) • [Brasil](#) • [Canada](#) • [Chile](#) • [China](#) • [Colombia](#) • [Czech Republic](#) • [Dubai](#) • [Egypt](#) • [Hong Kong](#) • [Hungary](#) • [India](#) • [Indonesia](#) • [Korea](#) • [Malaysia](#) • [Mexico](#) • [Morocco](#) • [New Zealand](#) • [Pakistan](#) • [Paraguay](#) • [Peru](#) • [Philippines](#) • [Poland](#) • [Russia](#) • [Singapore](#) • [South Africa](#) • [Taiwan](#) • [Thailand](#) • [Turkey](#) • [Uruguay](#) • [Venezuela](#)

## Eastern Europe

### CZECH REPUBLIC

Philips Service  
V Mezihorí 2180 00 Prague  
Phone: (02)-6831581  
Fax : (02)-66310852

### HUNGARY

Philips Markaszerviz.  
Kinizsi U 30-36Budapest 1092  
Phone: (01)-2164428  
Fax : (01)-2187885

### POLAND

Philips Polska CE  
UL.Marszalkowska 45/49  
00-648 Warszawa  
Phone: (02)-6286070  
Fax : (02)-6288228

## RUSSIA

Philips Representation Office  
Ul. Usacheva 35a  
119048 Moscow  
Phone: 095-937 9300  
Fax : 095-755 6923

## TURKEY

Türk Philips Ticaret A.S.  
Talatpasa Caddesi No 5.  
80640-Gültepe/Istanbul  
Phone: (0800)-211 40 36  
Fax : (0212)-281 1809

## Latin America

### ANTILLES

Philips Antillana N.V.  
Kaminda A.J.E. Kusters 4  
Zeelandia, P.O. box 3523-3051  
Willemstad, Curacao  
Phone: (09)-4612799  
Fax : (09)-4612772

### ARGENTINA

Philips Antillana N.V.  
Vedia 3892 Capital Federal  
CP: 1430 Buenos Aires  
Phone: (011)-4544 2047

### BRASIL

Philips da Amazônia Ind. Elet. Ltda.  
Av. Luis Carlos Berrini,  
1400 - Sao Paulo -SP  
Phone: 0800-701-0203

## CHILE

Philips Chilena S.A.  
Avenida Santa Maria 0760  
P.O. box 2687 Santiago de Chile  
Phone: (02)-730 2000  
Fax : (02)-777 6730

## COLOMBIA

Industrias Philips de Colombia  
S.A.-Division de Servicio  
CARRERA 15 Nr. 104-33  
Bogota, Colombia  
Phone:(01)-8000 111001 (toll free)  
Fax : (01)-619-4300/619-4104

## MEXICO

Consumer Information Centre  
Norte 45 No.669  
Col. Industrial Vallejo  
C.P.02300, -Mexico, D.F.  
Phone: (05)-3687788 / 9180050462  
Fax : (05)-7284272

## PARAGUAY

Philips del Paraguay S.A.  
Avenida Artigas 1513  
Casilla de Correos 605  
Asuncion  
Phone: (021)-211666  
Fax : (021)-213007

## PERU

Philips Peruana S.A.  
Customer Desk  
Comandante Espinar 719  
Casilla 1841  
Limab18  
Phone: (01)-2136200  
Fax : (01)-2136276

## URUGUAY

Ind.Philips del Uruguay S.A.  
Luis Alberto de Herrera 1248  
Customer Help Desk  
11300 Montevideo  
Phone: (02)-6281111  
Fax : (02)-6287777

## VENEZUELA

Industrias Venezolanas Philips S.A.  
Apartado Postal 1167  
Caracas 1010-A  
Phone: (02) 2377575  
Fax : (02) 2376420

## Canada

### CANADA

Philips Electronics Ltd.  
281 Hillmount Road  
Markham, Ontario L6C 2S3  
Phone: (800) 479-6696

## Pacific

### AUSTRALIA

Philips Consumer Service.  
Customer Information Centre.  
3 Figtree Drive  
Homebush Bay NSW 2140  
Phone: CIC: 1300-363 391      PCE Service: 1300-361 392 (toll free)  
Fax : +61 2 9947 0063

## NEW ZEALAND

Philips New Zealand Ltd.  
Consumer Help Desk  
2 Wagener Place, Mt.Albert  
P.O. box 1041  
Auckland  
Phone: 0800 477 999 (toll free)  
Fax : 0800 288 588 (toll free)

## Asia

### BANGLADESH

Philips Service Centre  
100 Kazi Nazrul Islam  
Avenue Kawran Bazar C/A  
Dhaka-1215  
Phone: (02)-812909  
Fax : (02)-813062

### CHINA

BEIJING  
Beijing Authorized Service Centre.  
Consumer Information Centre  
Building 6, West Street  
Chong Wen Men, Beijing, Jin Bang Co. Led.  
100051 BEIJING

GUANGZHOU  
Philips Authorized Service Centre  
801 Dong Feng Road East  
Guangzhou 510080

SHANGHAI  
Philips Service Logistic Centre  
Consumer Information Centre  
P.O.Box 002-027, Nextage Department Store  
Puding New District  
200002 SHANGHAI

Philips Authorized Service Centre  
Consumer Information Centre  
148 Fu Jian Road M

200001 Shanghai

Phone: 800 820 5128 (toll free)

Fax: 21-656 10647

## HONG KONG

Philips Hong Kong Limited  
Consumer Information Centre  
16/F Hopewell Centre  
17 Kennedy Road, WANCHAI  
Phone: 2619 9663  
Fax : 2481 5847

## INDIA

Phone: 91-20-712 2048 ext: 2765

Fax: 91-20-712 1558

### BOMBAY

Philips India

Customer Relation Centre

Bandbox House

254-D Dr. A Besant Road, Worli

Bombay 400 025

### CALCUTTA

Customer Relation Centre

7 justice Chandra Madhab Road

Calcutta 700 020

### MADRAS

Customer Relation Centre

3, Haddows Road

Madras 600 006

### NEW DELHI

Customer Relation Centre

68, Shivaji Marg

New Dehli 110 015

## INDONESIA

Philips Group of Companies in Indonesia  
Consumer Information Centre  
Jl.Buncit Raya Kav. 99-100  
12510 Jakarta  
Phone: (021)-794 0040 / 798 4255 ext: 1612  
Fax : (021)-794 7511 / 794 7539

## KOREA

Philips Korea Ltd.  
Philips House  
C.P.O. box 3680  
260-199, Itaewon-Dong.  
Yongsan-Ku, Seoul 140-202  
Phone:080-600-6600 (Local toll free)  
Fax : (02)-709-1245

## MALAYSIA

Philips Malaysia Sdn. Berhad  
Service Dept.  
No.51,sect.13 Jalan University.  
46200 Petaling Jaya, Selagor.  
P.O.box 12163  
50768 Kuala Lumpur.  
Phone: (03)-7950 5501/02  
Fax : (03)-7954 8504

## PAKISTAN

KARACHI  
Philips Electrical Ind. of Pakistan  
Consumer Information Centre  
F-54, S.I.T.E, P.O.Box 7101  
75730 KARACHI

Philips Consumer Service Centre  
168-F, Adamjee Road  
Rawalpindi Cantt

Phone: (021)-7731927  
Fax : (021)-7721167



## PHILIPPINES

Philips Electronics and Lighting Inc.  
106 Valero St., Salcedo Village  
Makati, Metro Manila.  
Phone: (02)-888 05 72  
Domestic toll free: 1-800-10-PHILIPS or 1-800-10-744 5477  
Fax : (02)-888 05 71

## SINGAPORE

Philips Singapore Private Ltd.  
Consumer Service Dept.  
Lorong 1, Toa Payoh., P.O. box 340  
Singapore 1231  
Phone: 6882 3999  
Fax : 6250 8037

## TAIWAN

Philips Taiwan Ltd.  
Consumer Information Centre  
13F, No. 3-1 Yuan Qu St., Nan Gang Dist.,  
Taipei 115, Taiwan  
Phone: 0800-231-099  
Fax : (02)-3789-2641

## THAILAND

Philips Electronics (Thailand) Ltd.  
Philips Service Centre  
209/2 Sanpavut Road,  
Bangna, Bangkok 10260  
Phone : (02)-652 8652  
Fax : (02)-614 3531

## Africa

## MOROCCO

Philips Electronique Maroc  
304,BD Mohamed V  
Casablanca  
Phone: (02)-302992  
Fax : (02)-303446

## SOUTH AFRICA

South African Philips.  
S.V. Div. 195 Main R.D.  
Martindale., Johannesburg  
P.O.box 58088  
Newville 2114  
Phone: +27 11 471 5000  
Fax : +27 11 471 5020

## Middle East

### DUBAI

Philips Middle East B.V.  
Consumer Information Centre  
P.O.Box 7785  
DUBAI  
Phone: (04)-335 3666  
Fax : (04)-335 3999

### EGYPT

Philips Egypt  
Consumer Information Centre  
10, Abdel Rahman El Rafei  
Mohandessin - Cairo, P.O.Box 242  
DOKKI  
Phone: (02)-3313993  
Fax : (02)-3492142