

RS232

RS232 Daisy Chain Cable



IR Sensor Cable

HDMI Cable

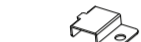

SD card cover



M3

* Differences according to regions.

Display design and accessories may differ from those illustrated above.

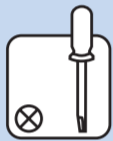

1

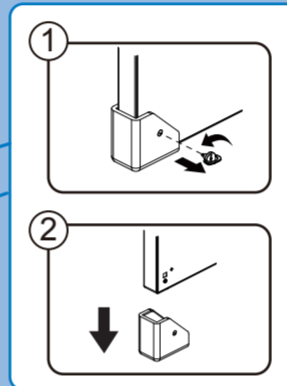
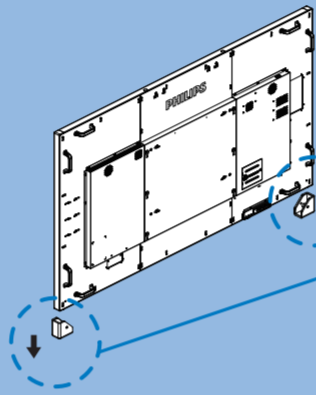
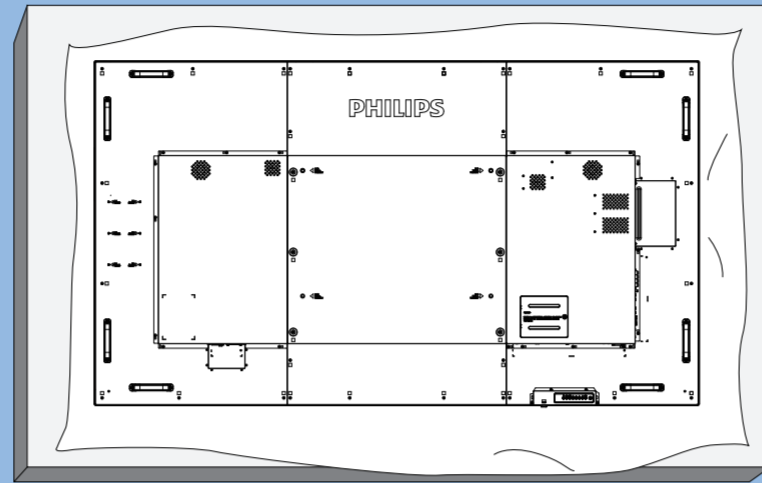

2

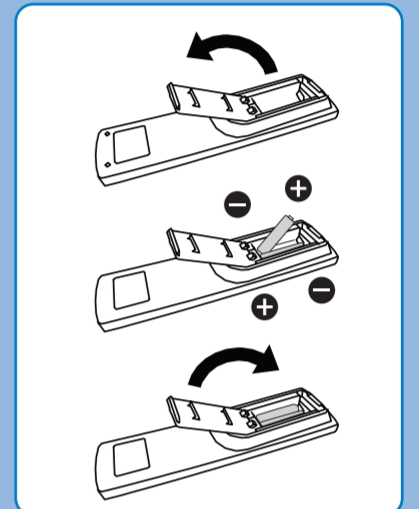
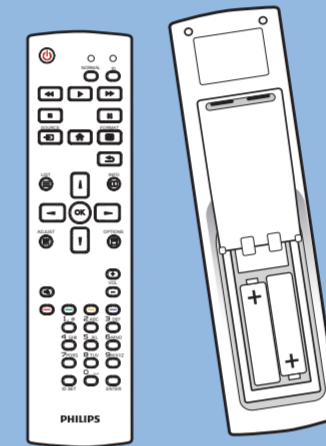
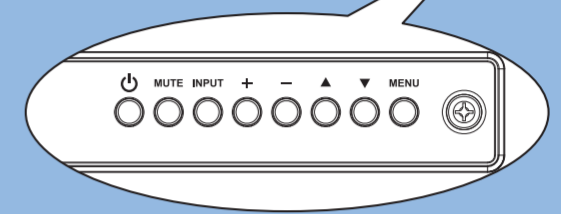
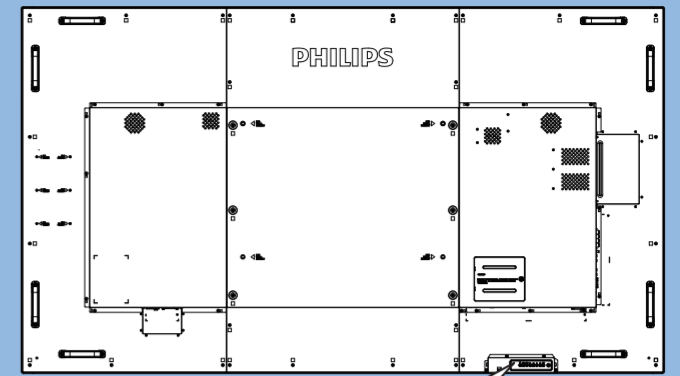

3

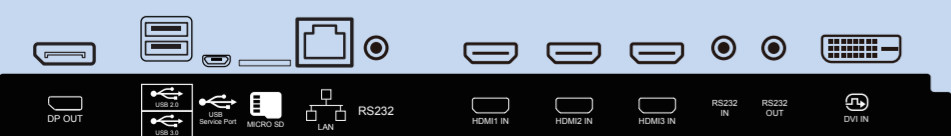
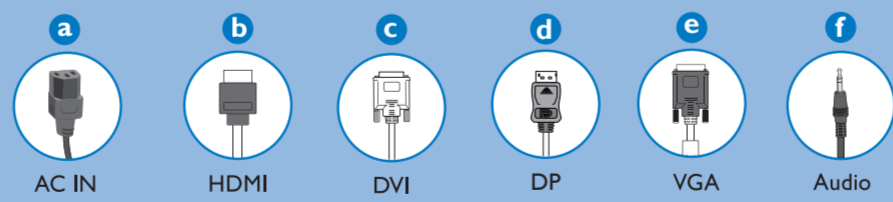
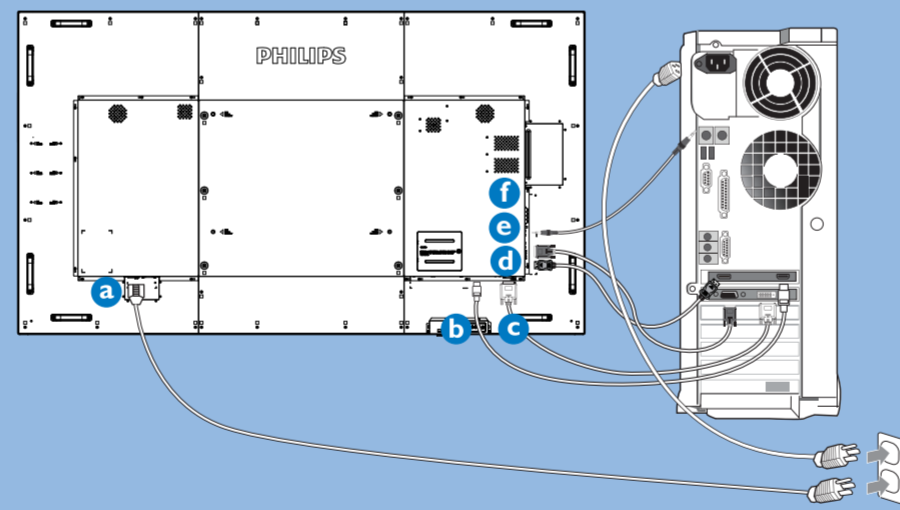
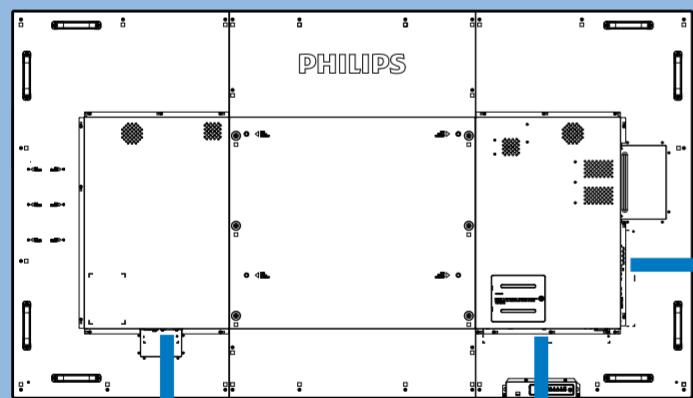

4

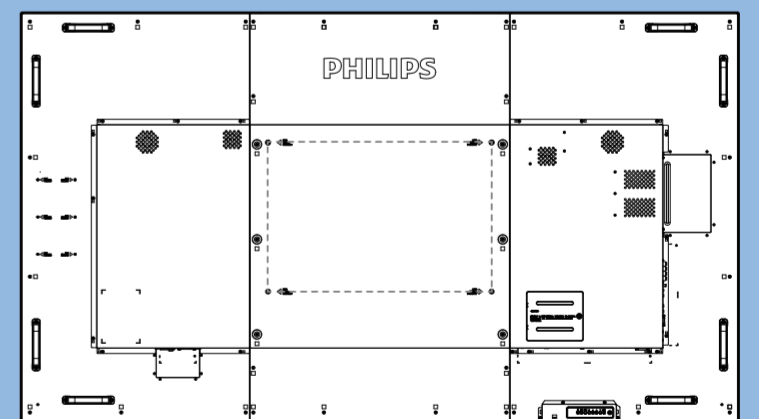
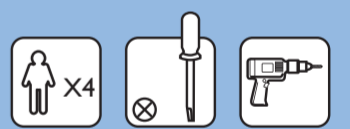

M8 * (15+X) mm
(X=Thickness of Wall mount BKT)

86BDL4150D: 600mmx400mm

5

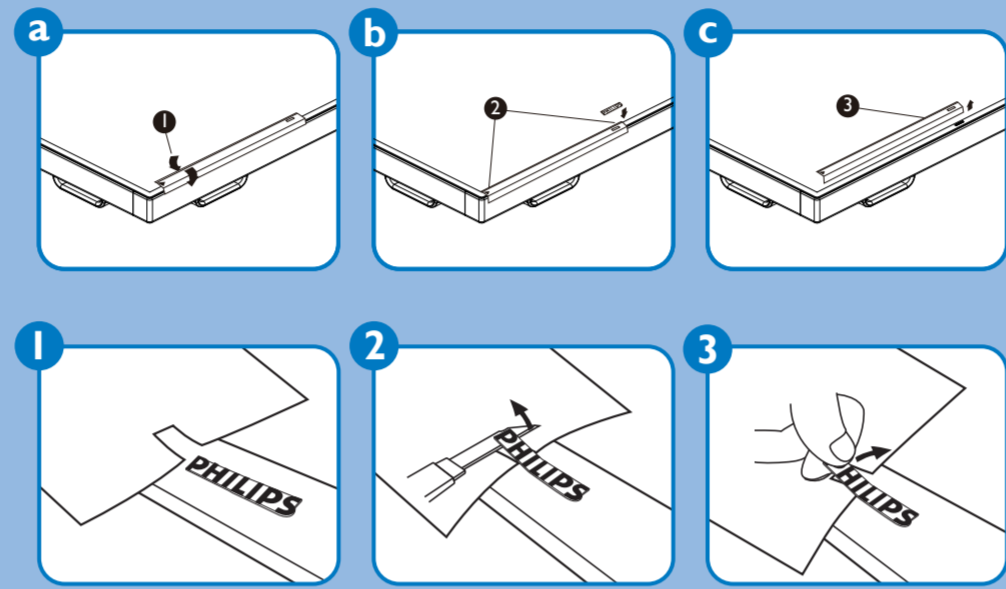
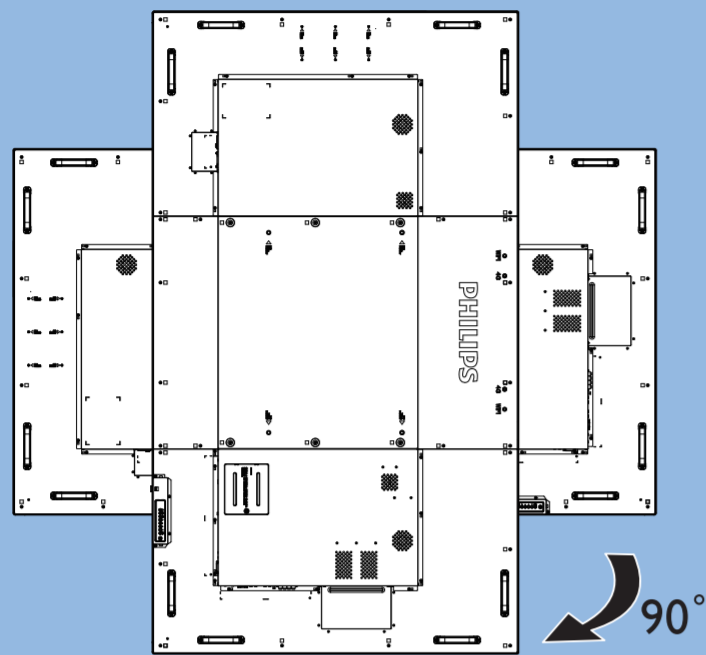

Please check out the website below for more product information.
www.philips.com/signagesolutions-support



86BDL4150D



Quick
Start

PHILIPS



© 2018 Koninklijke Philips N.V. All rights reserved.

Philips and the Philips Shield Emblem are registered trademarks of Koninklijke Philips N.V. and are used under license from Koninklijke Philips N.V.

Specifications are subject to change without notice.

Version:V1.00 2018-07-31

