

PHILIPS

Television

Quick Start Guide

8008 series

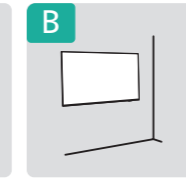
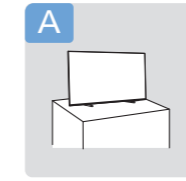
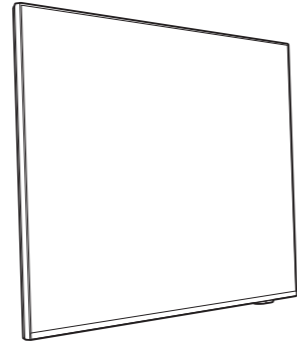

Register to find out more and get support
www.philips.com/TVsupport

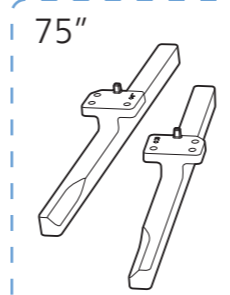
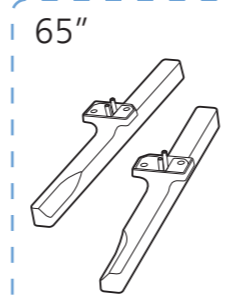
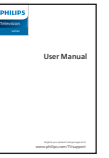
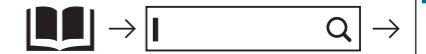

65" (M4xL20) : x4
75" (M5xL20) : x6

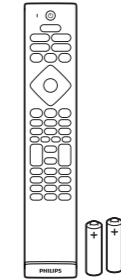
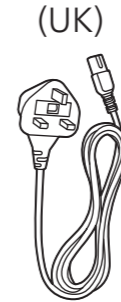
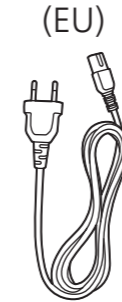

A 1 65"/75"

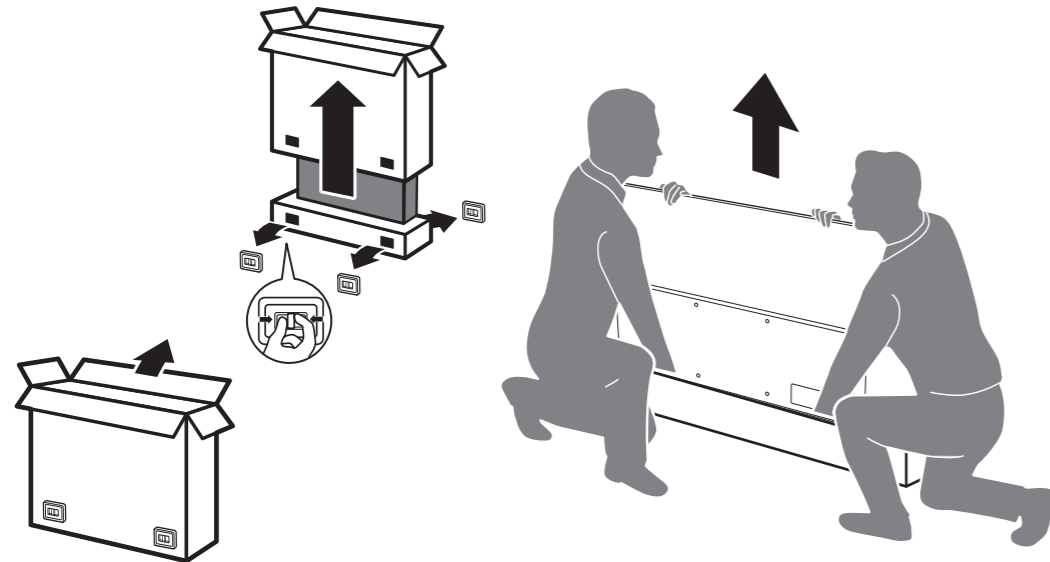

2

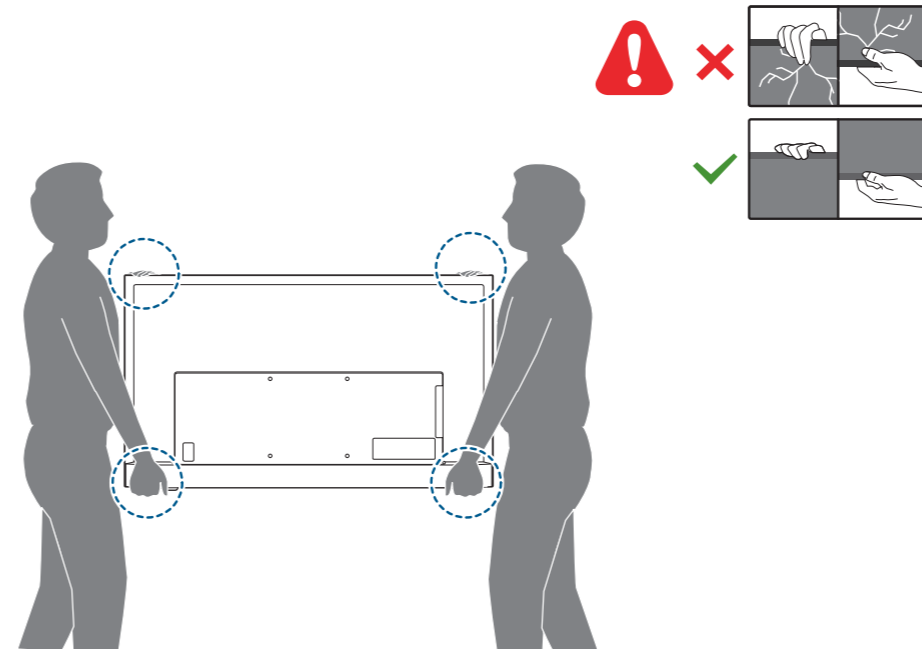

3

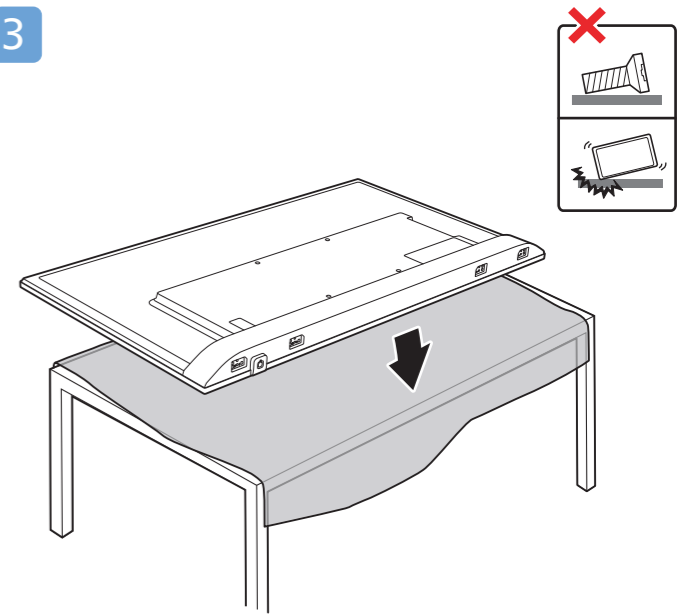

4

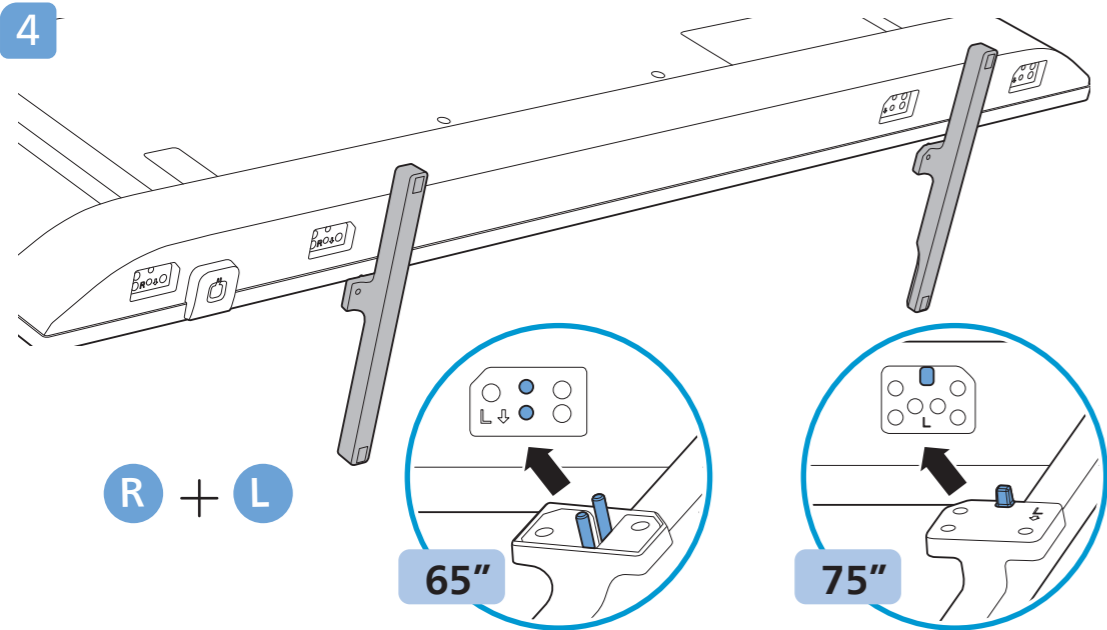

5

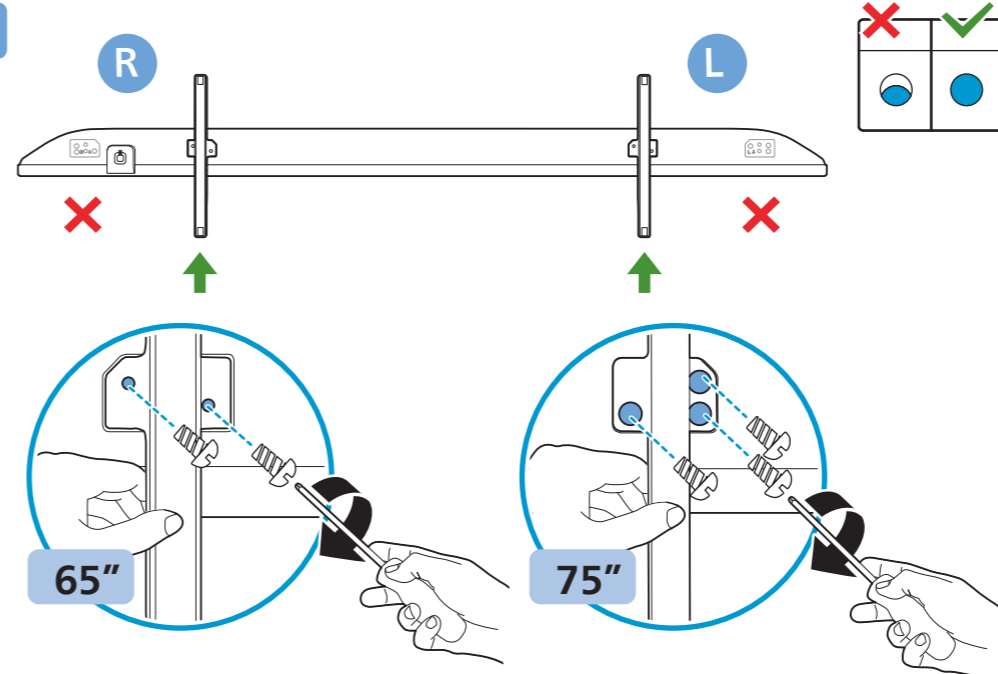

6

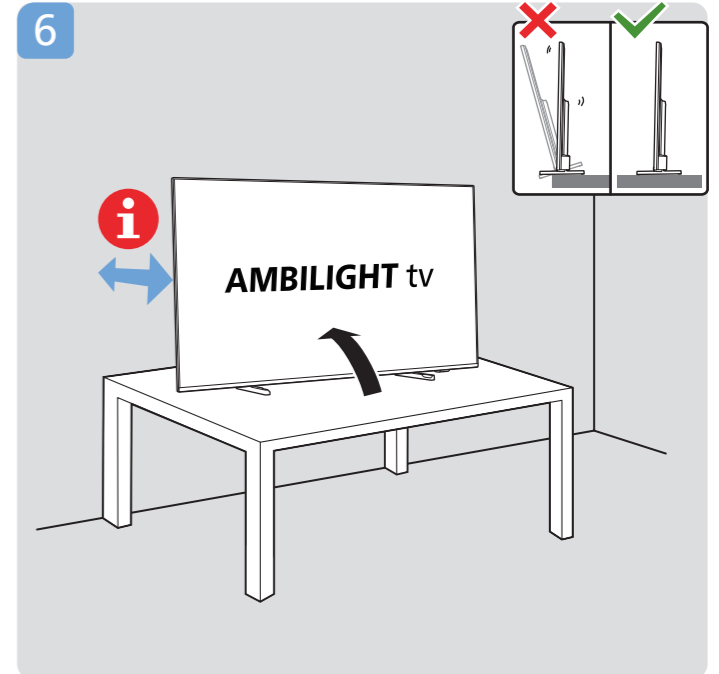

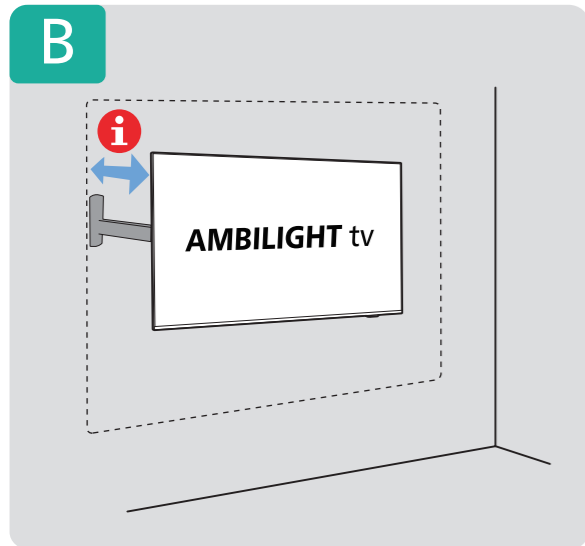

Wall Mount dimensions (x, y)

65" 300x300mm M6 (L: 12mm~20mm)
164 cm

75" 300x300mm M8 (L: 12mm~25mm)
189 cm

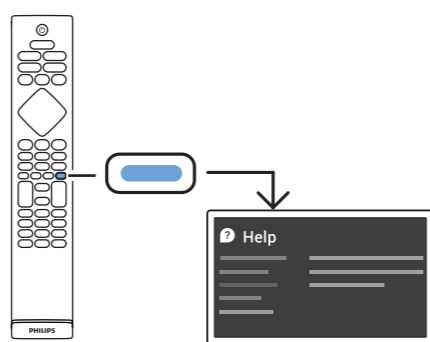
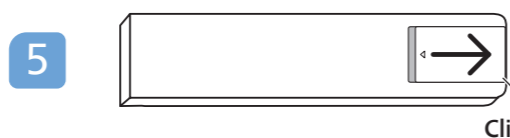
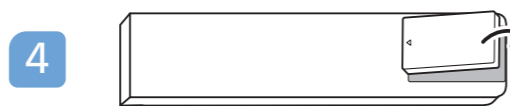
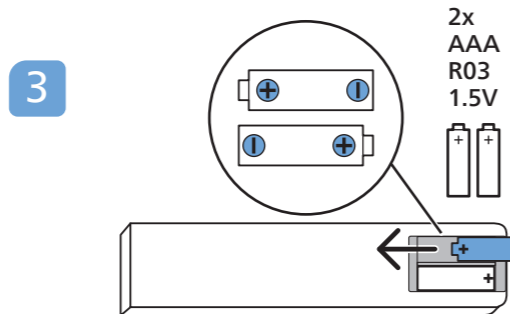
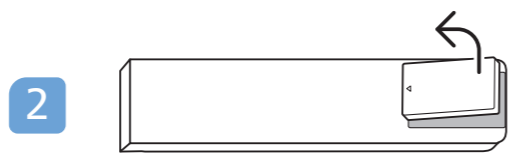
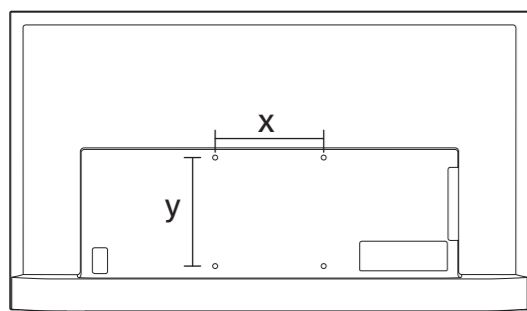
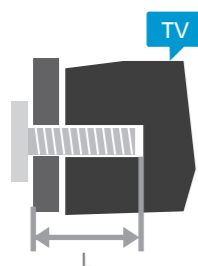

English Read the safety instructions.
Български Прочетете инструкциите за безопасност.
Čeština Přečtěte si bezpečnostní pokyny.
Hrvatski Pročitajte sigurnosne upute.
Dansk Læs sikkerhedsforskrifterne.
Deutsch Lesen Sie die Sicherheitshinweise.
Ελληνικά Διαβάστε τις οδηγίες ασφαλείας.
Eesti Lugege ohutusnõudeid.
Español Lea las instrucciones de seguridad.

Français Lisez les consignes de sécurité.
Italiano Leggere le istruzioni di sicurezza.
Қазақша Қорғаныстық нұсқаулар.
Latviešu Izlasiet drošības norādījumus.
Lietuvių Perskaitykite saugos instrukcijas.
Magyar Olvassa el a biztonsági utasításokat.
Nederlands Lees de veiligheidsvoorschriften.
Norsk Les sikkerhetsforskrifterne.
Polski Zapoznaj się z instrukcjami bezpieczeństwa.

Português Leia as instruções de segurança.
Română Citiți instrucțiunile de siguranță.
Русский Читайте инструкции по технике безопасности.
Srpski Pročitajte bezbednosna uputstva.
Slovenščina Preberite varnostna navodila.
Slovenský Prečítajte si bezpečnostné pokyny.
Suomi Lue turvaohjeet.
Svenska Läs säkerhetsinstruktionerna.
ภาษาไทย โปรดอ่านคำแนะนำด้านความปลอดภัย

Türkçe Güvenlik talimatlarını okuyun.
Українська Читайте інструкції з техніки безпеки.
العربية قراءة تعليمات السلامة.
עברית קראו את הוראות הבטיחות

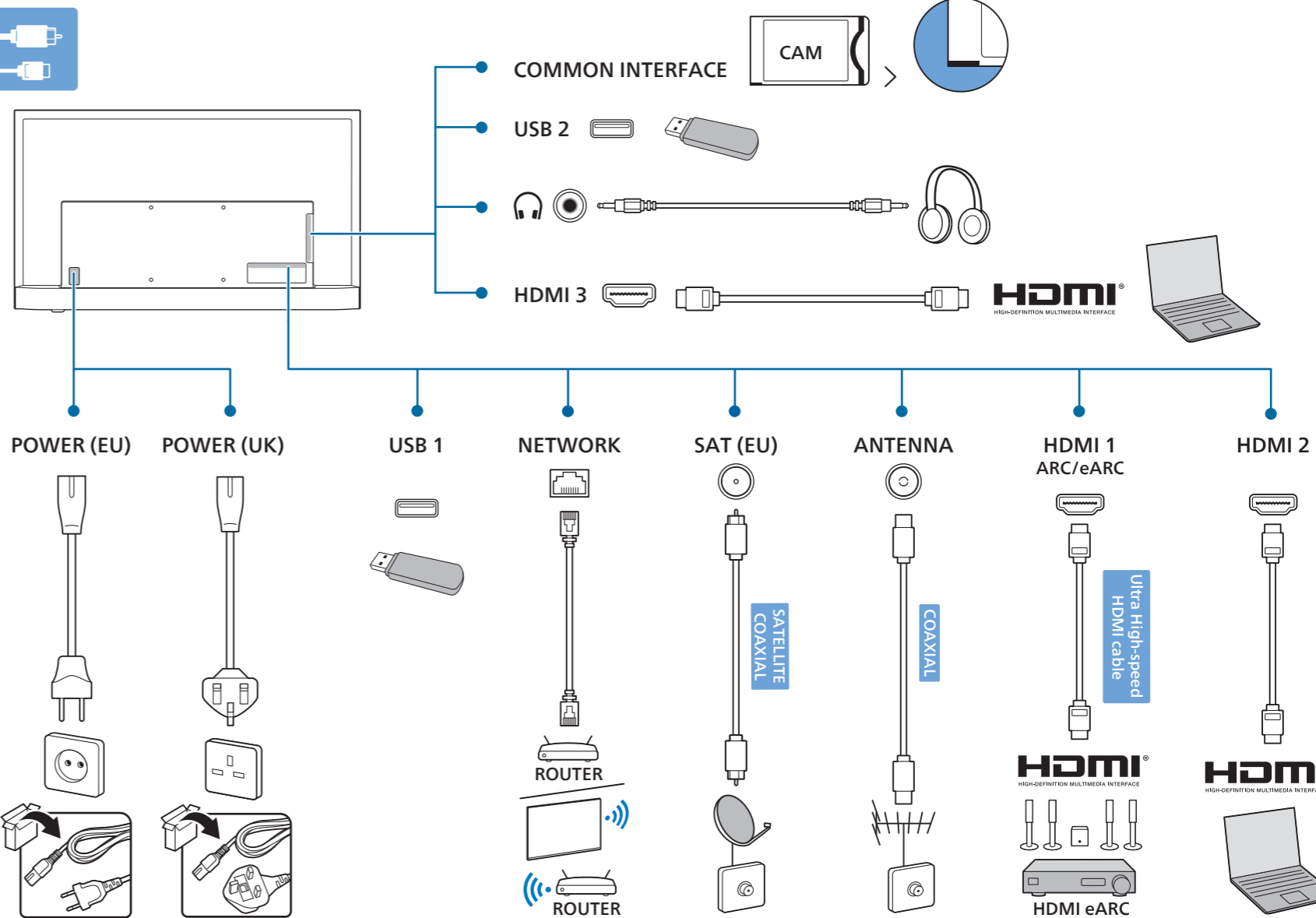
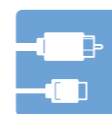

A 10 to 20 cm **B** 7 to 10 cm

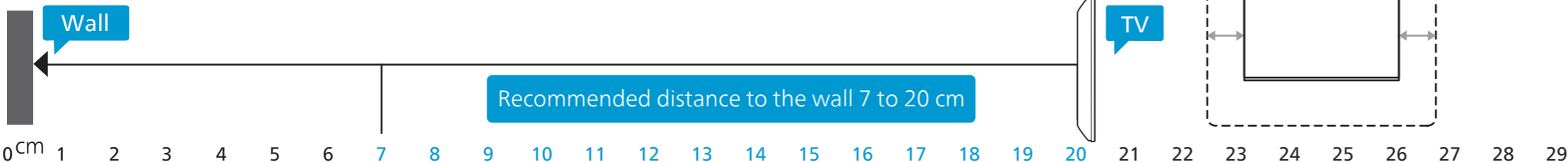

All registered and unregistered trademarks are property of their respective owners. Specifications are subject to change without notice. Philips and the Philips' shield emblem are trademarks of Koninklijke Philips N.V. and are used under license from Koninklijke Philips N.V. This product has been manufactured by and is sold under the responsibility of TP Vision Europe B.V., and TP Vision Europe B.V. is the warrantor in relation to this product. 2023 © TP Vision Europe B.V. All rights reserved. www.philips.com/welcome