

VGA

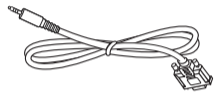

RS232

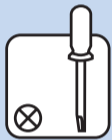

1

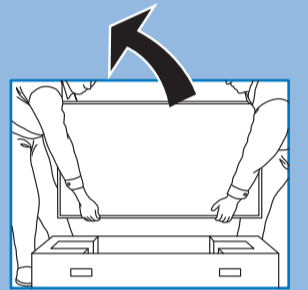
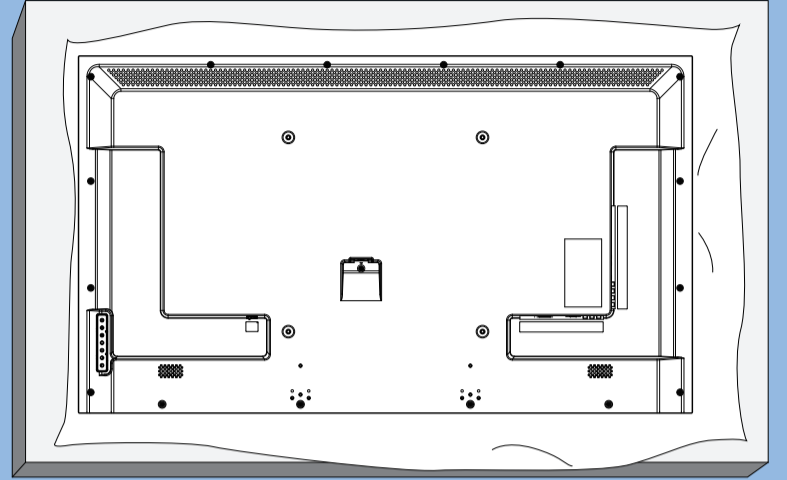

2

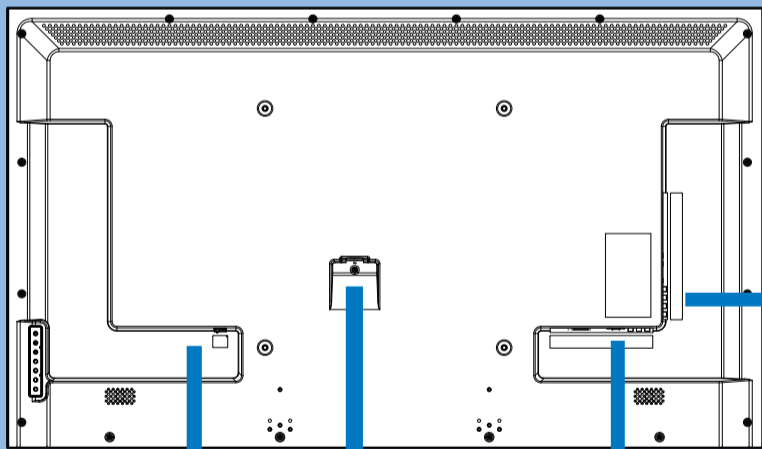

AC SWITCH



AC IN

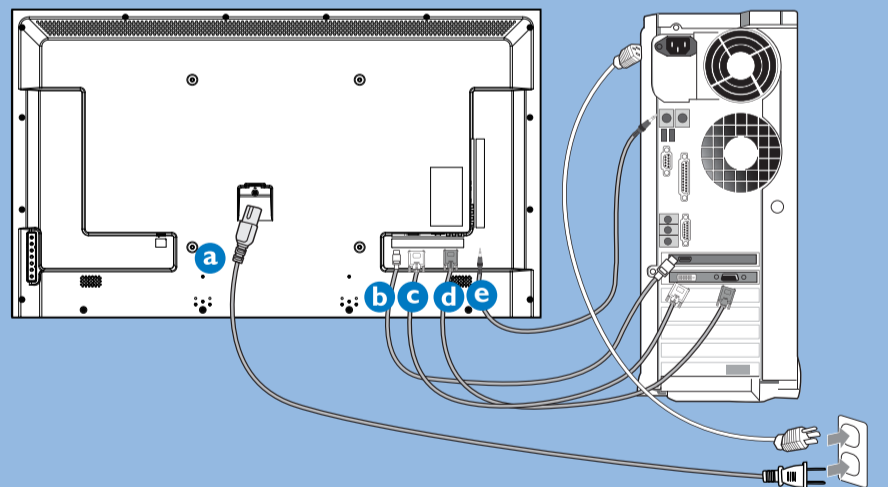

AC IN



HDMI

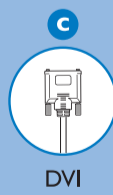

DVI

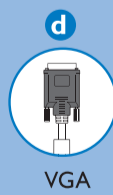

VGA



Audio In



HDMI



DVI(DVI-D) IN



RJ45

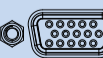

VGA IN



Y/CVBS Pb Pr



AUDIO IN



AUDIO OUT



PC LINE IN



SPDIF OUT



IR OUT

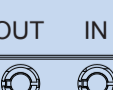

IR IN



RS232 OUT IN



USB

Register your product and get support at www.philips.com/welcome

BDL5520QL

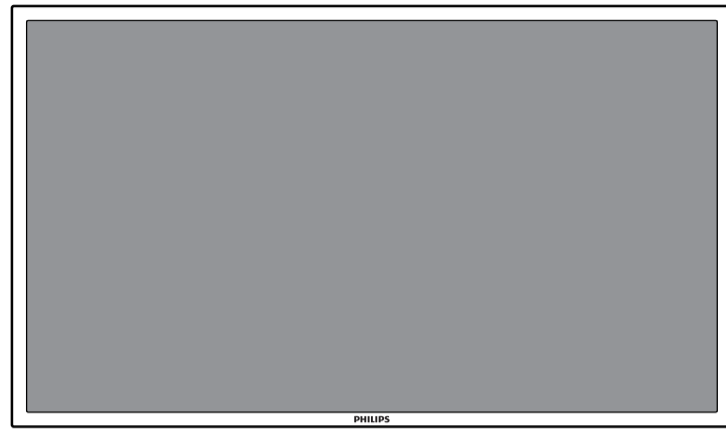

Quick Start

PHILIPS



3

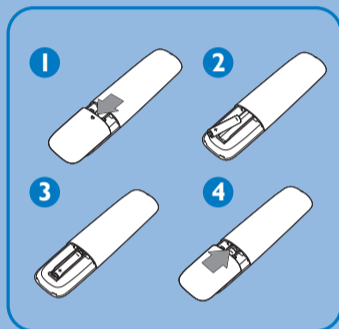
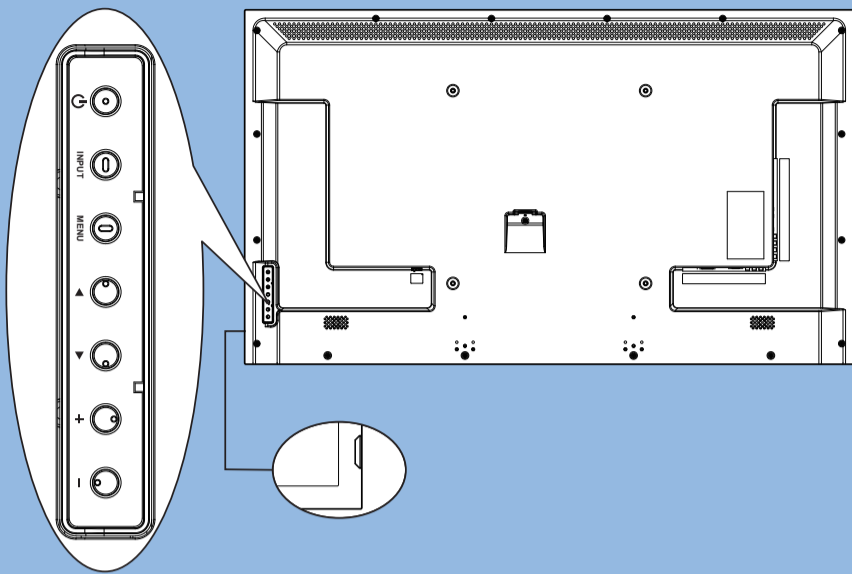

4

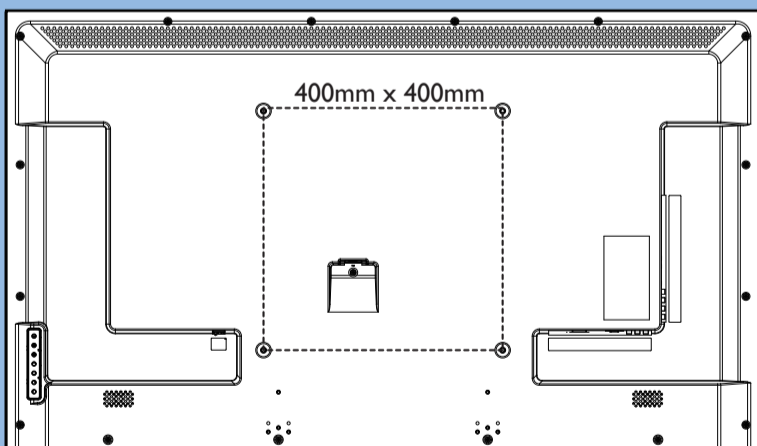

 M6 x 24 mm

© 2013 Koninklijke Philips N.V. All rights reserved.

Philips and the Philips Shield Emblem are registered trademarks of Koninklijke Philips N.V. and are used under license from Koninklijke Philips N.V.

Specifications are subject to change without notice.



Q41G55M181302B