

Power cord

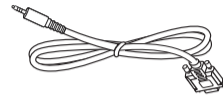

DVI Cable



RS232 Cable

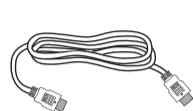

HDMI Cable

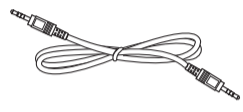

RS232 Daisy Chain Cable

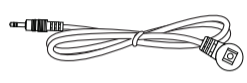

IR Sensor Cable



IR Cable

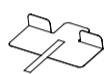

x 3



x 2

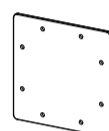

x 1

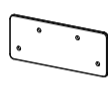

x 2



x 8

\* Differences according to regions.

Display design and accessories may differ from those illustrated above.

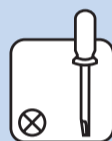
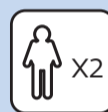

1

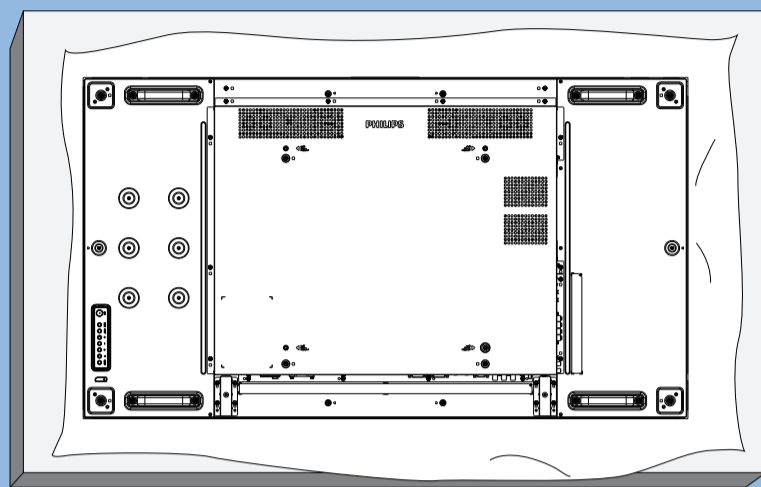

2

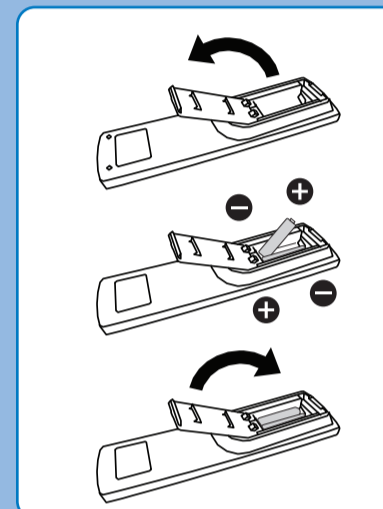
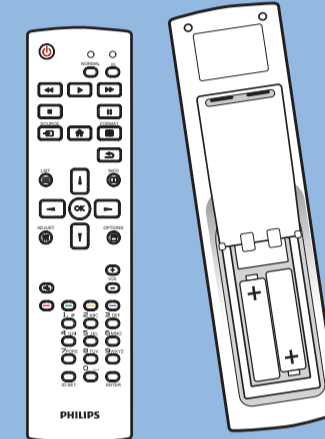
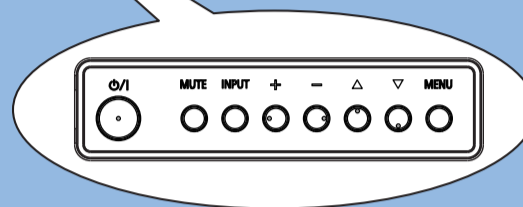
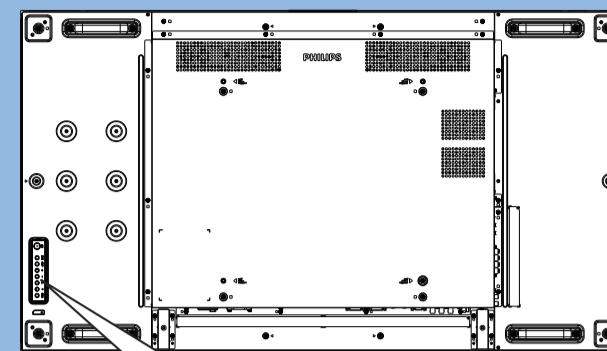

3

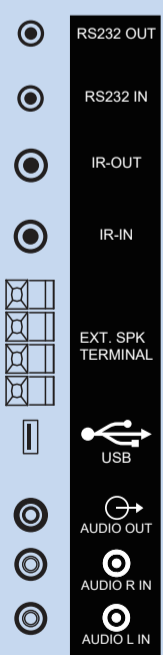
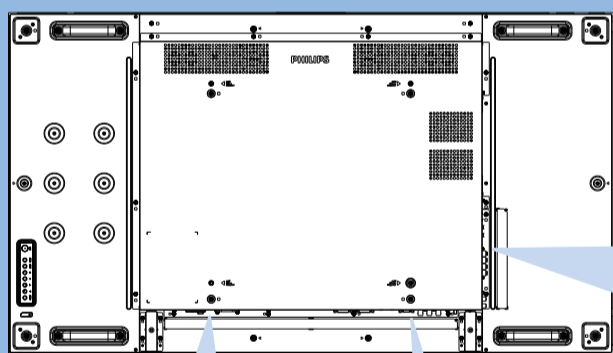

100-240V~  
50-60Hz 2.5A

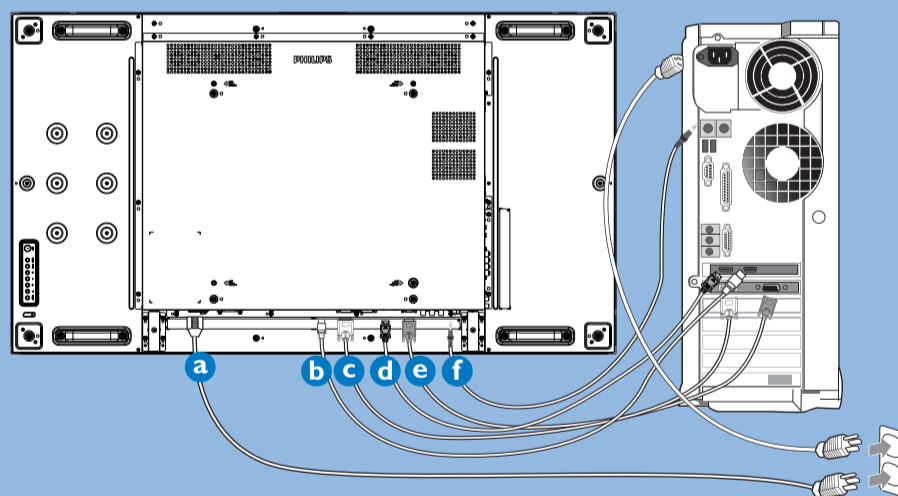

AC IN



HDMI



DVI



DP

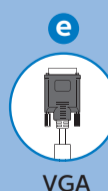

VGA



AUDIO

4

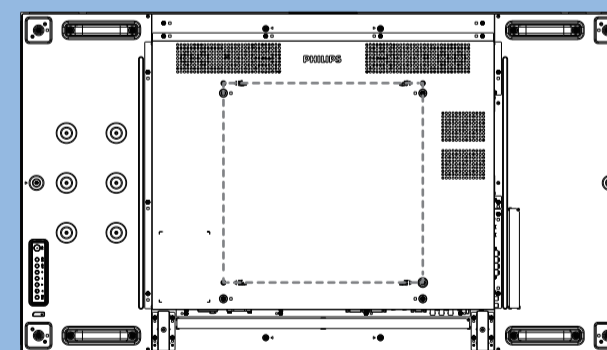

M6 \* (10+X) mm  
(X=Thickness of Wall mount BKT)  
55BDL2005X: 400mm x 400mm

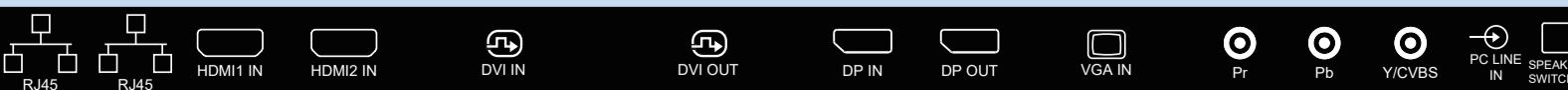

5

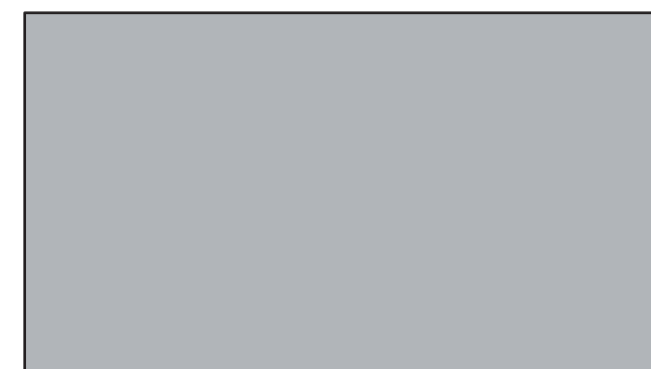
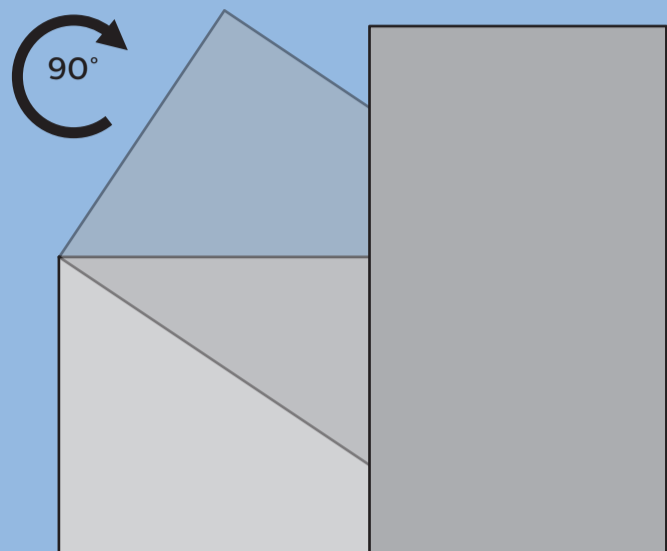

# Quick Start



Please check out the website below for more product information.  
[www.philips.com/signagesolutions-support](http://www.philips.com/signagesolutions-support)

6

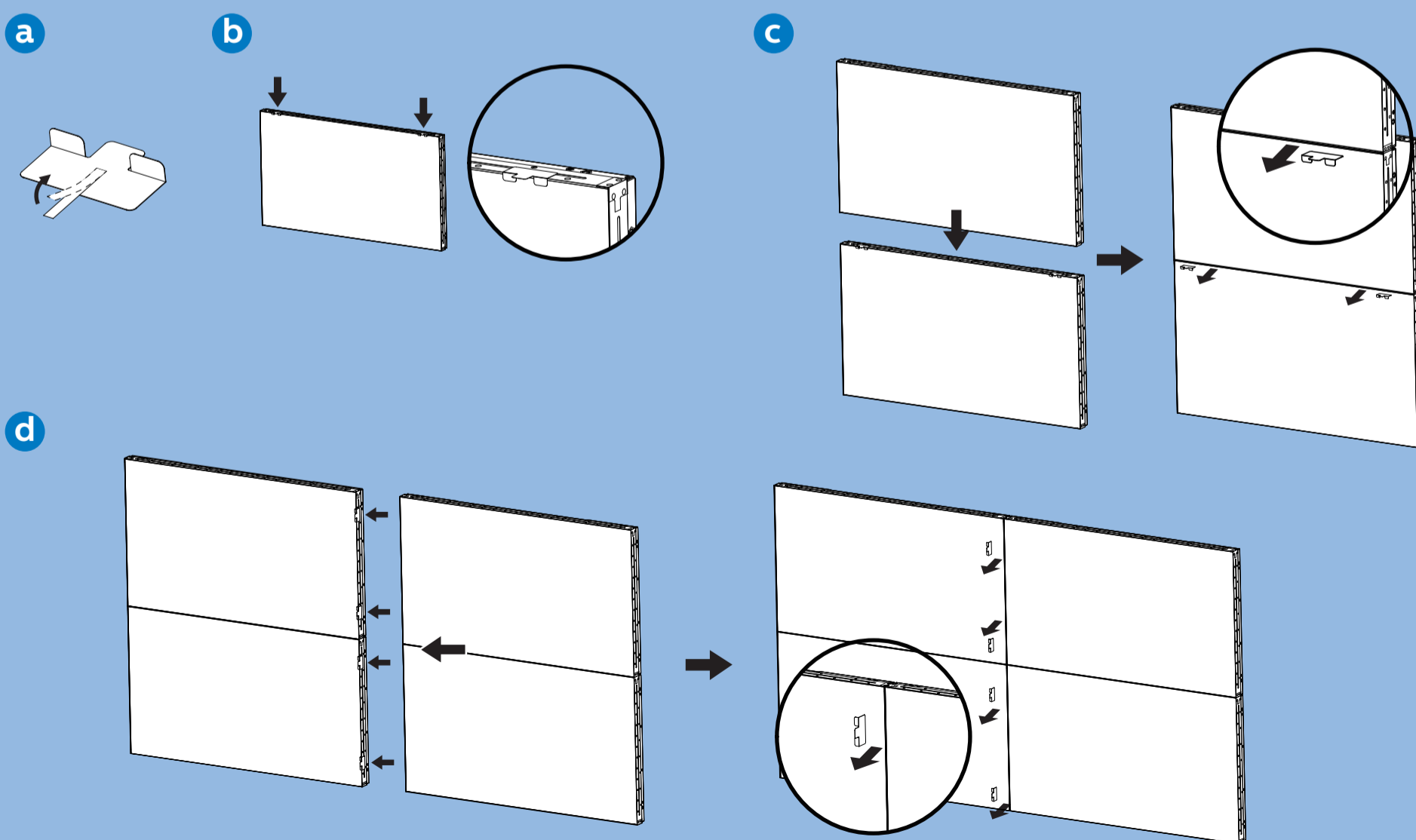

Envision Peripherals Inc.  
 490 N McCarthy Blvd, Suite #120  
 Milpitas, CA 95035  
 USA

© 2020 Koninklijke Philips N.V. All rights reserved.  
 Philips and the Philips Shield Emblem are registered  
 trademarks of Koninklijke Philips N.V. and are used under  
 license from Koninklijke Philips N.V.

Specifications are subject to change without notice.  
 Version: V1.00 2020-08-18

