

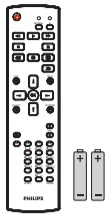

86BDL4150D/11

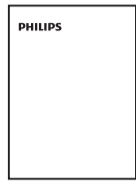

リモコンと
リモコン用乾電池



保証書

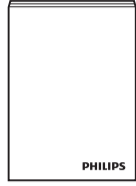

クイック
スタートガイド

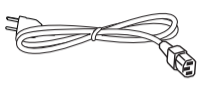

電源ケーブル



RS232 ケーブル



RS232 デイジー
チェーンケーブル

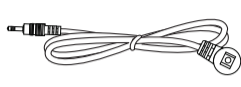

IR センサーケーブル



D-sub ケーブル

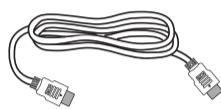

HDMI ケーブル



Philips ロゴ

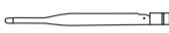

ダイポールア
ンテナ x2

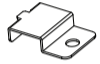

SD カードカバー



M3 ネジ x1



M2 ネジ x3

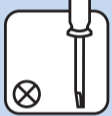

I

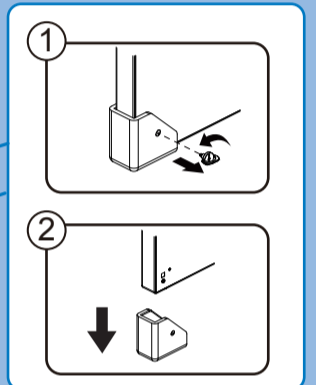
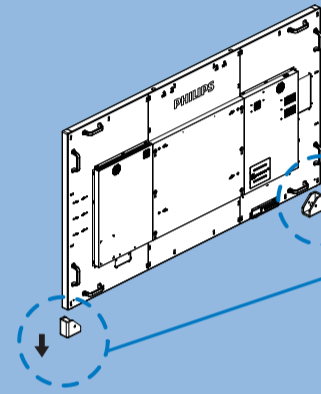
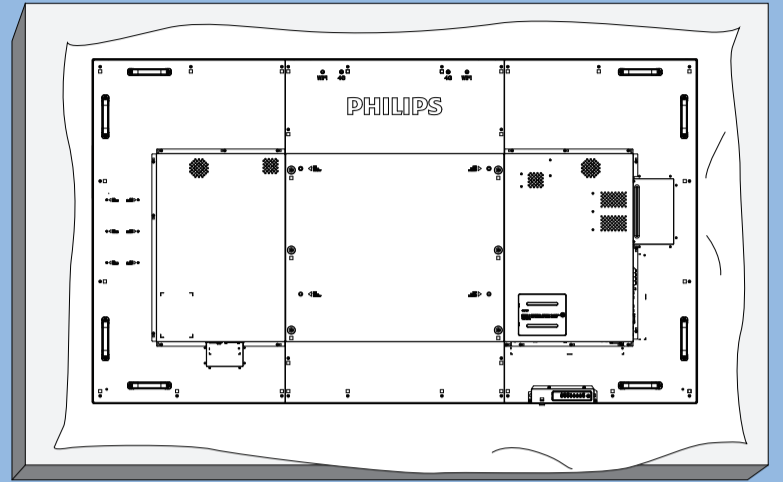

2

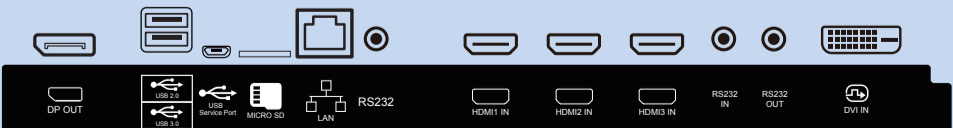
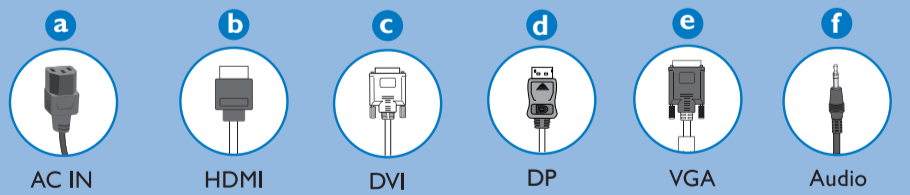
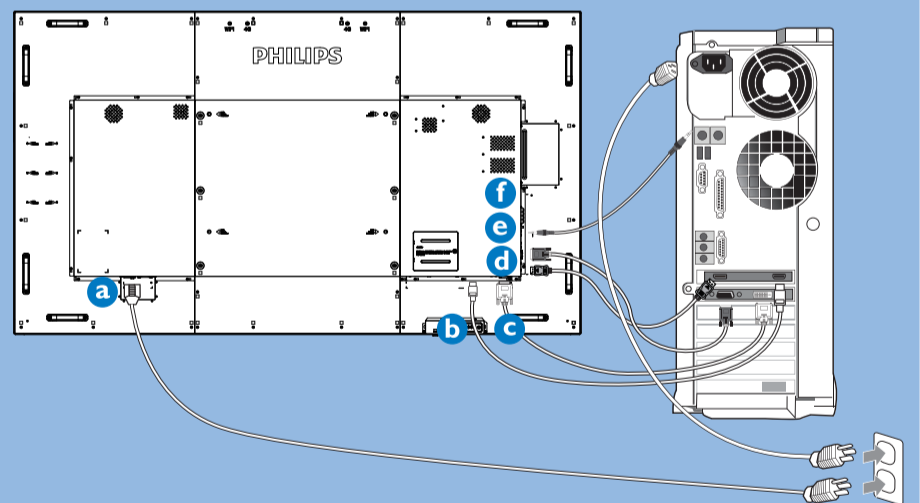
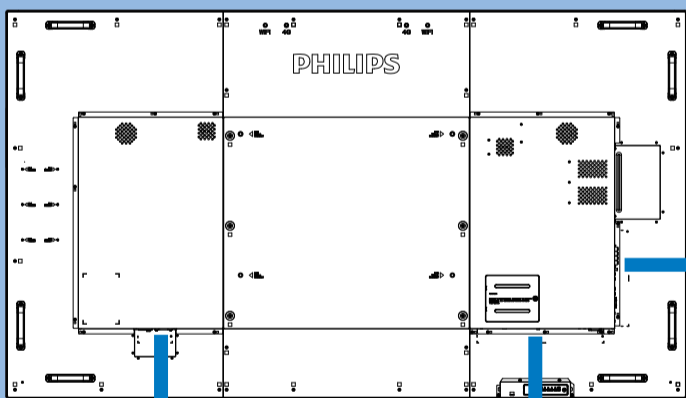

3

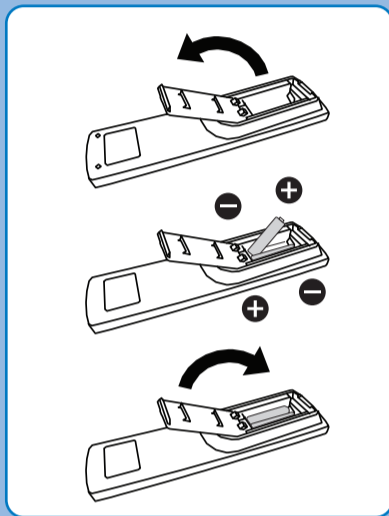
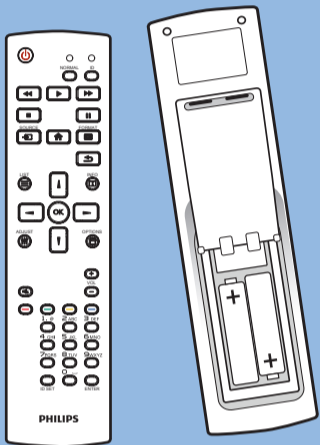
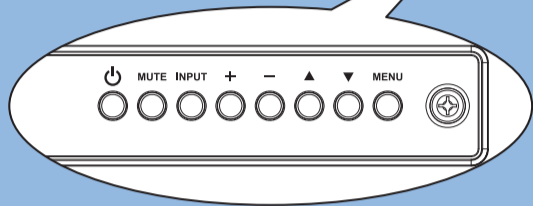
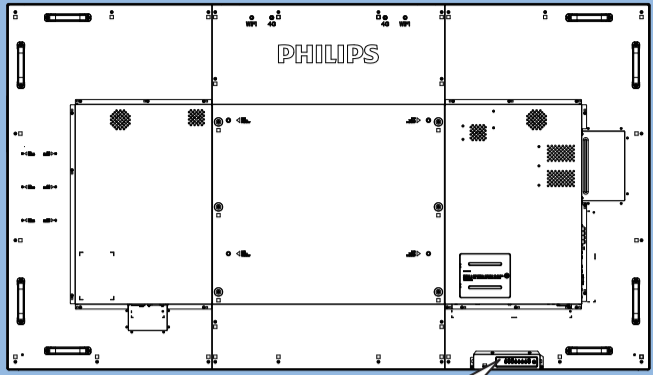

Register your product and get support at <http://www.philips.co.jp/>

86BDL4150D/11



Quick Start

PHILIPS

4

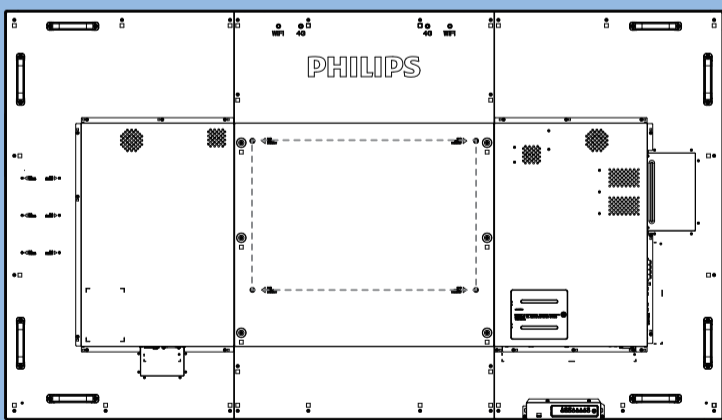

M8 * (15+X) mm
(X=Thickness of Wall mount BKT)

86BDL4150D: 600mmx400mm



© 2018 Koninklijke Philips N.V. All rights reserved.

Philips and the Philips Shield Emblem are registered trademarks of Koninklijke Philips N.V. and are used under license from Koninklijke Philips N.V.

Specifications are subject to change without notice.

Version:V1.00 2018-07-31



Q41G86M181304B