

Power cord

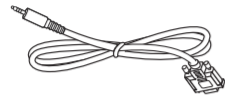

RS232

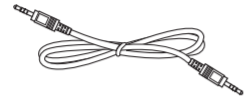

RS232 Daisy Chain Cable



Logo



x 8

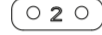

x 2



x 1

* Differences according to regions.

Display design and accessories may differ from those illustrated above.

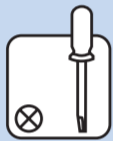

1

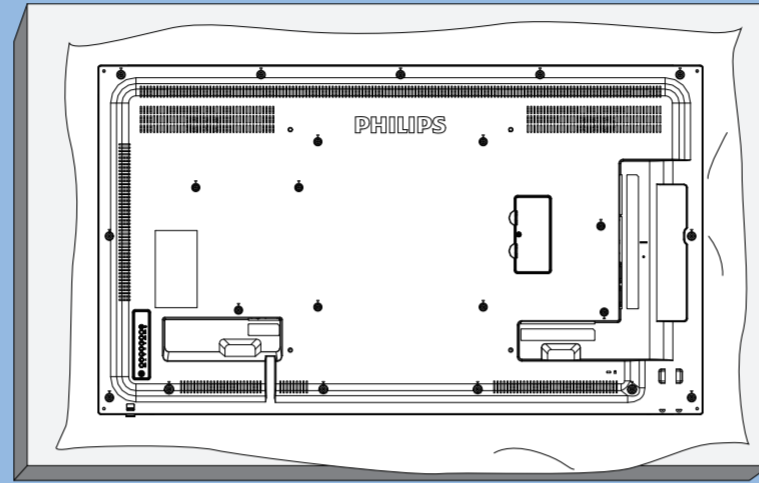

2

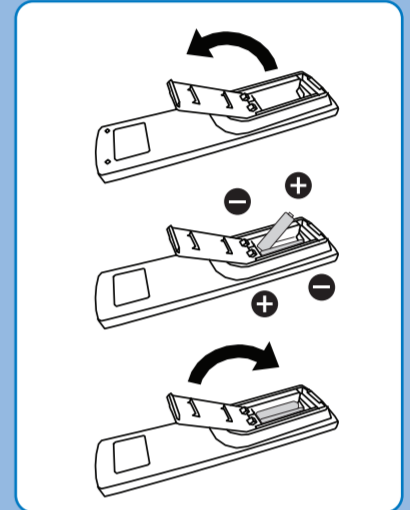
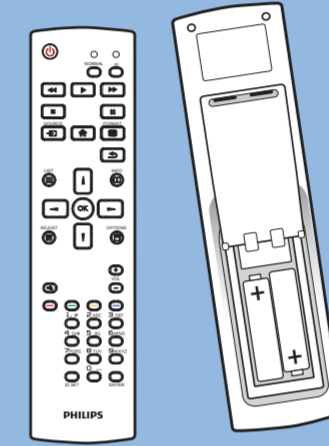
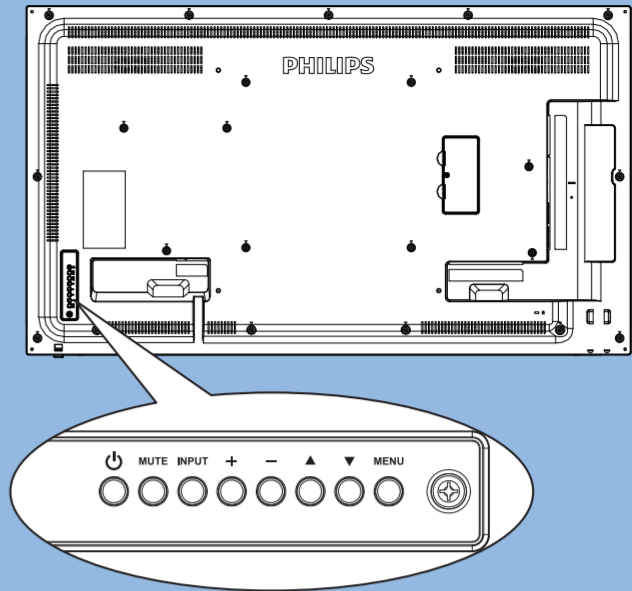

3

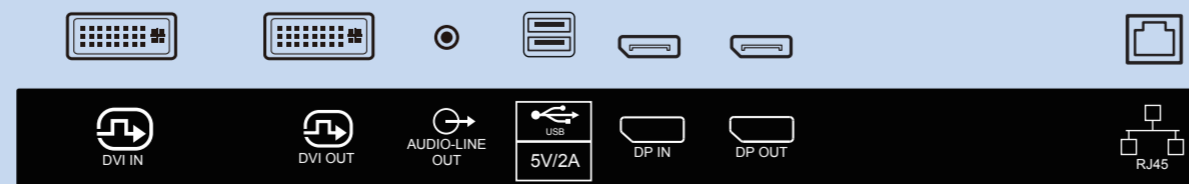
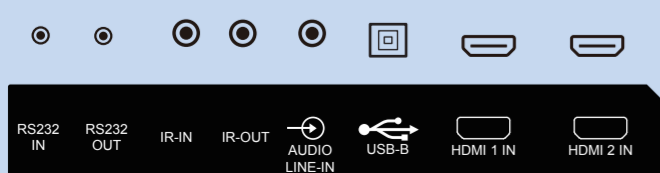
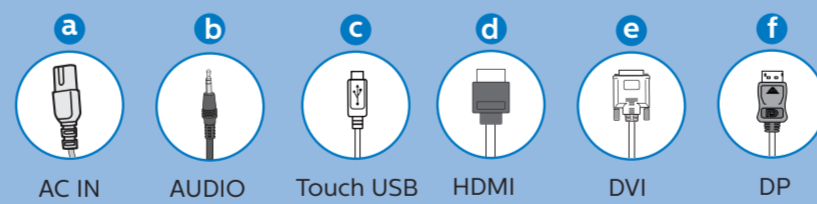
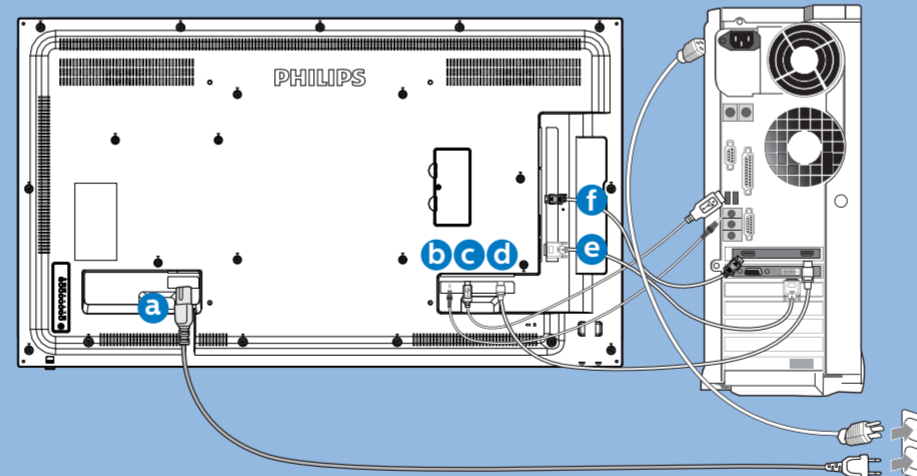
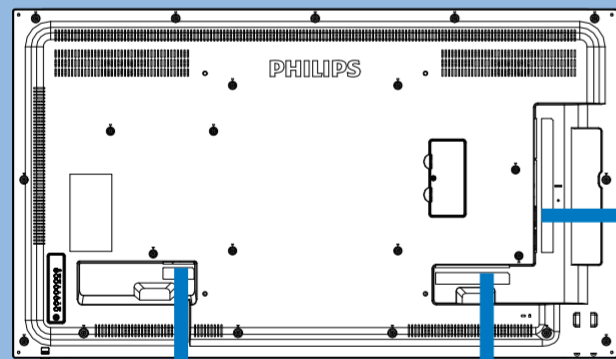

4

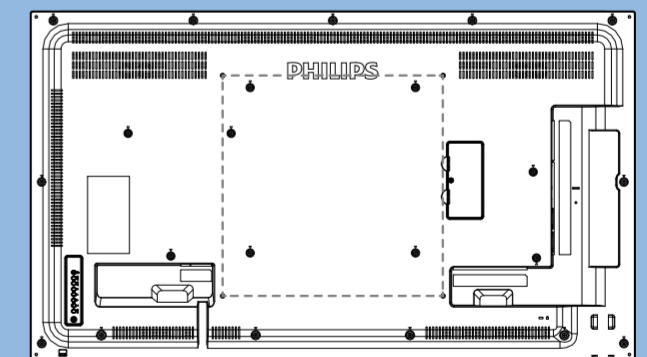

M6 * (10+X) mm
(X=Thickness of Wall mount BKT)
49BDL4031D: 400mmx400mm

5

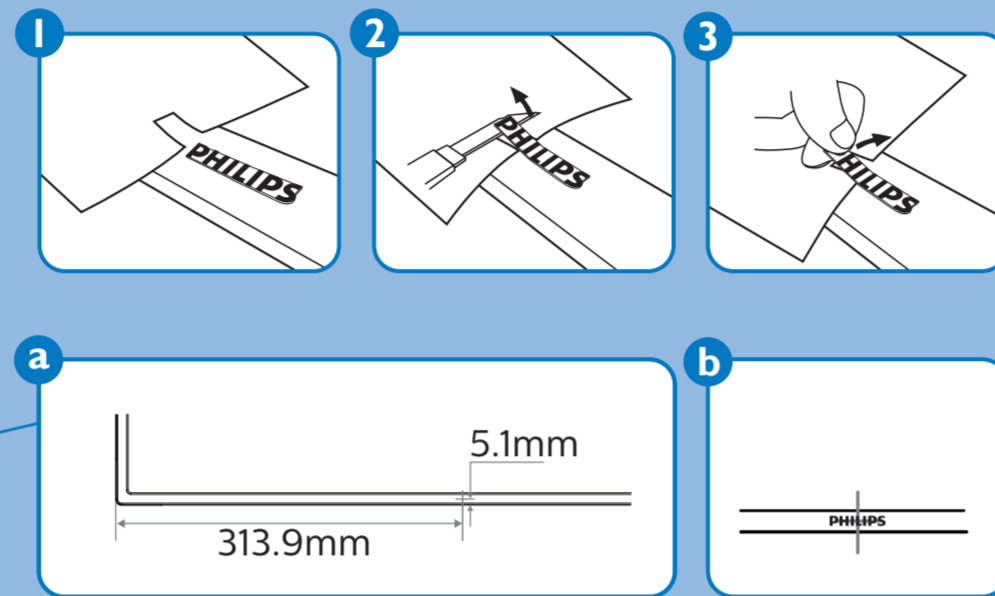
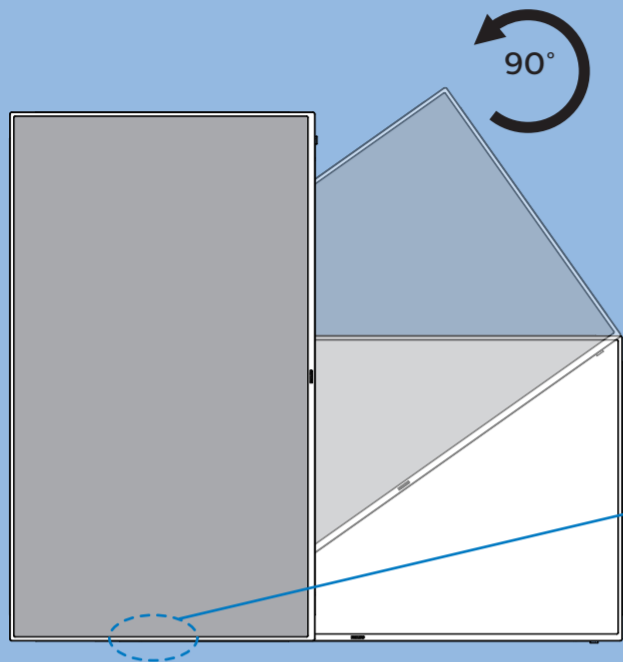

PHILIPS

D line

49BDL4031D



Quick Start



Please check out the website below for more product information.
www.philips.com/signagesolutions-support



Envision Peripherals Inc.
 490 N McCarthy Blvd, Suite #120
 Milpitas, CA 95035
 USA

© 2019 Koninklijke Philips N.V. All rights reserved.
 Philips and the Philips Shield Emblem are registered
 trademarks of Koninklijke Philips N.V. and are used under
 license from Koninklijke Philips N.V.

Specifications are subject to change without notice.

Version: V1.00 2019-07-18



Q41G49M181320A