

PHILIPS

Television

5600 Series

User Manual

32PHT5678

43PFT5678

Register your product and get support at
www.philips.com/TVsupport

Table of contents

1 Caution	2
------------------	----------

2 Important	4
Safety	4

3 Overview of your TV	7
Remote control	7
Using the remote control	8

4 Using the TV	9
Switching the TV on or off	9
Switch channels	9
Watch connected devices	10
Adjust the TV volume	10

5 Other uses of the TV	11
Accessing the TV menu	11
Changing the picture and sound settings	11
Function settings	12
Using the timer	13
Child lock settings	14
Playing multimedia files from USB devices	14
Updating the TV software	15
Restoring factory settings	15

6 Setting up channels	16
Setting up channels automatically	16
Editing channel list	16
TV Guide	16

7 Connecting the TV	17
Down ports	17
Side ports	17
Connecting to a computer	18
Using HDMI CEC	19

8 Product information	20
Display resolutions	20
Multimedia	20
Audio output power	20
Intrinsic resolution	20
Tuner/reception/transmission	20
Remote control	20
Power supply	20
Supported TV mounts	20

9 Troubleshooting	22
General issues	22
Channel issues	22
Picture issues	22
Sound issues	23
HDMI connection issues	23
Computer connection issues	23
Contact us	23

10 Warranty	24
--------------------	-----------

1 Caution

2023© TP Vision Europe B.V. All rights reserved. Specifications are subject to change without notice. All trademarks are the property of Koninklijke Philips N.V. or their respective owners. TP Vision Europe B.V. reserves the right to change products at any time without being obliged to adjust previously supplied products. The material in this manual is adequate for the intended use of the system. If the product, or its individual modules or procedures, are used for purposes other than those specified herein, their validity and suitability must first be confirmed. TP Vision Europe B.V. warrants that the material itself does not infringe upon any patents from the United States. No further warranty is expressed or implied. TP Vision Europe B.V. accepts no responsibility for any errors in the content of this document, nor for any issues that arise due to the content of this document. Errors reported to Philips will be rectified and published on the Philips support website as quickly as possible.

Terms of warranty

- Risk of injury, damage to the TV or voided warranty! Never attempt to repair the TV yourself.
- Please only use the TV and accessories as set out by the manufacturer.
- The caution sign printed on the back of the TV indicates the risk of electric shock. Never remove the TV cover. Please contact Philips Customer Support if repairs are needed.
- Operations expressly prohibited in this manual, or any adjustments and assembly steps that are not recommended or authorised in this manual, are not within the scope of the warranty.

Pixel characteristics

This TV product has a high number of colour pixels. Although it has effective

pixels of 99.999% or more, black dots or bright points of light (red, green or blue) may appear constantly on the screen. This is a structural property of the display (within common industry standards) and is not a malfunction. Therefore, please note this is not subjected to repair, exchange or refund within and/or out of the warranty period.

Backlight characteristics

All Philips TV have gone through stringent tests and checks before shipping to you. You can be rest assured that we place the quality of our TVs the utmost importance so that you do not suffer any viewing displeasure while watching your TV. However, please note that backlight bleeding ("Mura effect") and / or unevenness of background light that can only be observed in dark images or in a very dark and dim room are considered to be within TV specifications. Such occurrences do not represent a deterioration nor shall be regarded as a defect of the TV. Hence, we regret that claims of this nature for warranty, free of charge service, replacement or refund cannot be accepted within and/or out of the warranty period.

Copyright



®Kensington and Micro Saver are registered US trademarks of ACCO World Corporation with issued registrations and pending applications in other countries and regions throughout the world.

HDMI[®]
HIGH-DEFINITION MULTIMEDIA INTERFACE

The terms HDMI, HDMI High-Definition Multimedia Interface, HDMI Trade dress and the HDMI Logos are trademarks or registered trademarks of HDMI Licensing Administrator, Inc.

Dolby Audio

Manufactured under license from Dolby Laboratories. Dolby, Dolby Audio and the double-D symbol are registered trademarks of Dolby Laboratories Licensing Corporation.

Advance™

Covered by one or more claims of the HEVC patents listed at patentlist.accessadvance.com.

Future proof with advanced HEVC decoding.

2 Important

Please read and make sure you understand all instructions before using the TV.

Damage caused by a failure to follow the instructions is not covered by the warranty.

Safety

Risk of electric shock or fire!

- Never expose the TV to rain or water. Never place liquid containers (such as vases) next to the TV. If liquids are spilled on or inside the TV, disconnect the TV from the power supply immediately. Contact the Philips Customer Service Centre to have the TV checked before you use it again.
- Never place the TV, remote control or batteries near naked flames or other heat sources (including direct sunlight).

To avoid fire spreading, always keep candles or other naked flames away from the TV, remote control and batteries.



- Never insert any objects into the ventilation slots or other openings on the TV.
- Make sure that no strain is placed on the power cable when swivelling the TV. Strain on the power cable can loosen connections and cause arcing.
- The power plug of the TV must be disconnected to disconnect the TV from the mains supply. When you disconnect the power, always pull out the power plug, and never the cable. Ensure that the power plug, power cable and outlet socket are accessible at all times.

- The power plug is a disconnection device and should be kept so that it is easy to operate.

Risk of short circuit or fire!

- Never expose the remote control or batteries to rain, water or excessive heat.
- Avoid pulling the power plug. Loose power plugs can lead to arcing or fire.

Risk of injury or damage to the TV!

- Two people are required to lift and carry a TV that weighs more than 25 kg or 55 lbs.
- When stand mounting the TV, use only the supplied stand. Secure the stand to the TV tightly. Place the TV on a flat, level surface that can support the combined weight of the TV and the stand.
- When wall mounting the TV, use only a wall mount that can support the weight of the TV. Secure the wall mount to a wall that can support the combined weight of the TV and wall mount. TP Vision Europe B.V. bears no responsibility for improper wall mounting that results in accident, injury or damage.
- If you need to store the TV, disassemble the stand from the TV. Never lay the TV on its back with the stand installed.
- Before you connect the TV to the power outlet, ensure that the power voltage matches the value printed on the back of the TV. Never connect the TV to the power outlet if the voltage is different.
- Parts of this product may be made of glass. Handle with care to avoid injury and damage.

Stability Hazards!

A television set may fall, causing serious personal injury or death. Many injuries, particularly to children, can be avoided by taking simple precautions such as:

- ALWAYS ensure the television set is not overhanging the edge of the supporting furniture.
- ALWAYS use cabinets or stands or mounting methods recommended by the manufacturer of the television set.
- ALWAYS use furniture that can safely support the television set.
- ALWAYS educate children about the dangers of climbing on furniture to reach the television set or its controls.
- ALWAYS route cords and cables connected to your television so they cannot be tripped over, pulled or grabbed.
- NEVER place a television set in an unstable location.
- NEVER place the television set on tall furniture (for example, cupboards or bookcases) without anchoring both the furniture and the television set to a suitable support.
- NEVER place the television set on cloth or other materials that may be located between the television set and supporting furniture.
- NEVER place items that might tempt children to climb, such as toys and remote controls, on the top of the television or furniture on which the television is placed.

If the existing television set is going to be retained and relocated, the same considerations as above should be applied.

Risk of batteries!

- Do not ingest the battery. Chemical burn hazard.
- The remote control may contain a coin/button cell battery. If the coin/button cell battery is swallowed, it can cause severe internal burns in just 2 hours and can lead to death.
- Keep new and used batteries away from children.

- If the battery compartment does not close securely, stop using the product and keep it away from children.
- If you think batteries might have been swallowed or placed inside any part of the body, seek immediate medical attention.
- Risk of fire or explosion if the battery is replaced by an incorrect type.
- Replacement of a battery with an incorrect type that can defeat a safeguard (for example, in the case of some lithium battery types).
- Disposal of a battery into fire or a hot oven, or mechanically crushing or cutting of a battery, that can result in an explosion.
- Leaving a battery in an extremely high temperature surrounding environment that can result in an explosion or the leakage of flammable liquid or gas.
- A battery subjected to extremely low air pressure that may result in an explosion or the leakage of flammable liquid or gas.

Risk of overheating!

- Never install the TV in a confined space. Always leave a space of at least 4 inches or 10 cm around the TV for ventilation. Ensure curtains or other objects never cover the ventilation slots on the TV.

Risk of injury, fire or power cord damage!

- Never place the TV or any objects on the power cord.
- Disconnect the TV from the power outlet and antenna before lightning storms. During lightning storms, never touch any part of the TV, power cord or antenna cable.

Risk of hearing damage!

- Avoid using earphones or headphones at high volumes or for prolonged periods of time.

Low temperatures

- If the TV is transported in temperatures below 5°C or 41°F, unpack the TV and wait until the TV temperature matches room temperature before connecting the TV to the power outlet.

Screen care

- Avoid static images as much as possible. Static images are images that remain onscreen for extended periods. Examples include onscreen menus, black bars and time displays. If you must use static images, reduce the screen contrast and brightness to avoid screen damage.
- Unplug the TV before cleaning.
- Use a soft damp cloth to wipe the TV and frame. Never use substances such as alcohol, chemical products or household cleaners to clean the TV.
- Risk of damage to the screen! Never touch, push, rub or strike the screen with an object.
- Wipe off any water as quickly as possible to avoid deformation and discolouration.



Note

Static images may cause permanent damage to the TV screen.

- Do not display static images on LCD TV screens for longer than 2 hours, as this can cause ghosting onscreen. To prevent ghosting, reduce the brightness and contrast of the screen when displaying static images.
- Watching programmes in 4:3 format for extended periods may leave different marks on the left and right of the screen and the border of the image. Therefore, avoid using this mode for prolonged periods.
- Displaying static images from video games and computers for extended periods may cause an afterimage

and ghosting due to screen burn. Reduce the screen brightness and contrast accordingly when using the TV in this way.

Any afterimages, ghosting or marks displayed on the TV screen due to the causes mentioned above are not covered by the warranty.

Recycling



This product has been manufactured using high-performance materials and components that can be recycled and reused.



When the crossed-out wheeled bin symbol is attached to a product, the product is covered by European Directive 2002/96/EC. Familiarise yourself with your local separate collection system for electrical and electronic products.

Follow local regulations and do not dispose of your old products with normal household waste.

Proper disposal of old products helps to prevent potential harm to the environment and human health.



This product contains batteries covered by European Directive 2006/66/EC. These batteries cannot be disposed of together with normal household waste. Educate yourself on local regulations covering the separate collection of batteries, as proper battery disposal helps to prevent harm to the environment and human health.

3 Overview of your TV

Congratulations on your purchase and welcome to Philips! To fully benefit from the support offered by Philips, please register your TV at www.philips.com/TVsupport.

Remote control

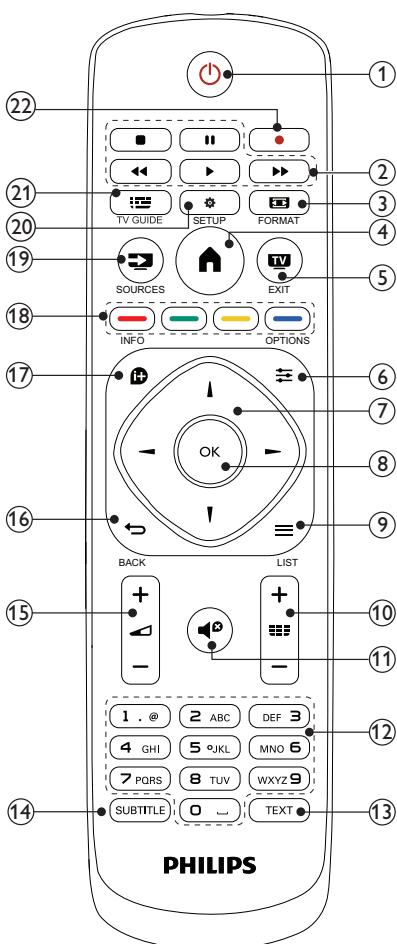

- ① **⏻ (Standby/On)**
Switch the TV on or to standby.
- ② **▶ (Playback buttons)**
Control video, music or text.
- ③ **📺 FORMAT**
Change picture format.
- ④ **🏠 (Home)**
Access or exit from the main menu and return to the previous menu.
- ⑤ **📺 EXIT**
Switches to TV.
- ⑥ **☰ OPTIONS**
In TV mode, access Options to select audio.
- ⑦ **▲▼◀▶ (Navigation buttons)**
Navigate through menus and select items.
- ⑧ **OK**
Confirm an entry or selection.
- ⑨ **☰ LIST**
Access or exit from the TV channel list.
- ⑩ **CH +/- (Channel +/-)**
Changes channels; scrolls up/down through the options in USB mode.
- ⑪ **🔇 (Mute)**
Mute or restore audio.
- ⑫ **0-9 (Numeric buttons 0-9)**
Select channel.
- ⑬ **TEXT**
Enable or disable teletext.
- ⑭ **SUBTITLE**
Select the subtitles.
- ⑮ **+/- (Volume)**
Adjust volume.
- ⑯ **↶ BACK**
Return to the previous menu or exit from a certain function, and switch to the previous channel or signal source.

- 17 **INFO**
Display information about current activity.
- 18 **Color buttons**
Select tasks or options.
- 19 **SOURCES**
Select connected devices
- 20 **SETUP**
Accesses TV setup menu.
- 21 **TV GUIDE**
Accesses or exits the TV guide.
- 22 **Red dot**
Recording function.

Using the remote control

When you use the remote control, hold it close to the TV and point it at the remote control sensor. Make sure that the line-of-sight between the remote control and TV is not blocked by furniture, walls or other objects.

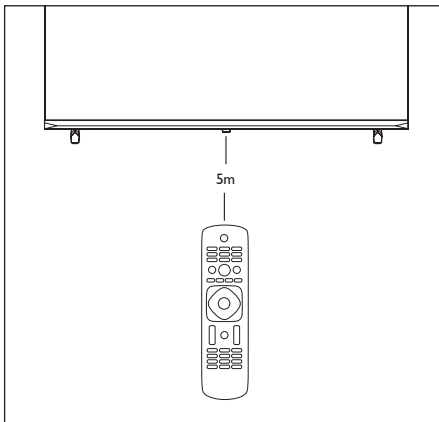

4 Using the TV

This section helps you to perform basic TV operations.

Switching the TV on or off

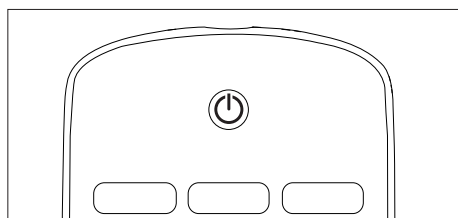
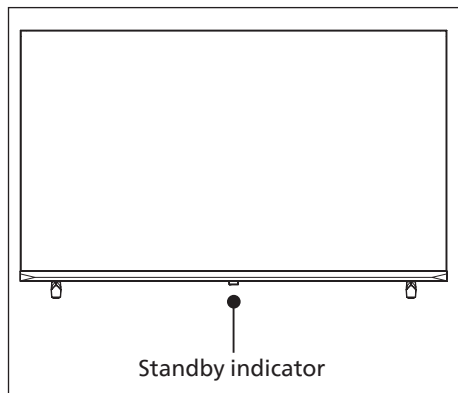

To switch on

- Plug in the power plug.
 - ↳ If the standby indicator is red, press  (Standby-On) on the remote control.

To switch to standby

- Press  (Standby-On) on the remote control.
 - ↳ The standby indicator switches to red.

Tip

- Though your TV consumes very little power when in standby mode, energy continues to be consumed. When not in use for an extended period of time, disconnect the TV power cable from the power outlet.

Switch channels

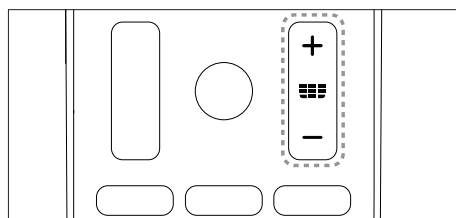



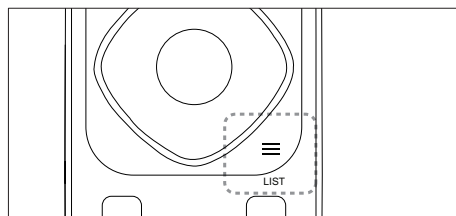

- Press CH+/- on the remote control .
- Enter a channel number using the numeric buttons on the remote control.
- Press  on the remote control to switch and return to the previous channel.

View installed channel

All available channels can be viewed in the channel list.





- 1 Press  LIST.
 - ↳ The channel list appears.
- 2 Press   to select channels and to browse the channel list.
- 3 Press OK to watch the selected channel.
- 4 Press  to switch and return to the last watched channel.

Watch connected devices

Note





- Switch on the device before selecting it as an external signal source.

To mute or unmute sound

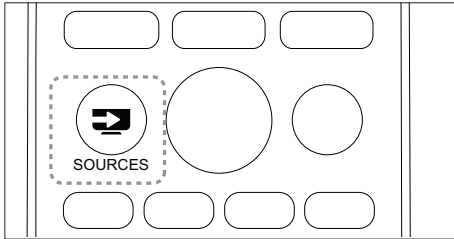
- Press  (Mute).
- Press  again to restore the sound.

Use the Sources button



- 1 Press  SOURCES.
↳ The source list appears.
- 2 Press   to select a device.
- 3 Press  to confirm.
↳ The TV switches to the selected device.

Adjust the TV volume

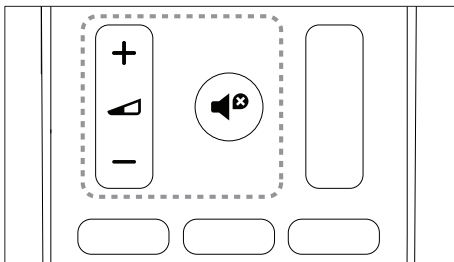

To increase or decrease volume

- Press Volume control +/- on the remote control.

5 Other uses of the TV

Accessing the TV menu

The menu helps you set up channels, change the picture and sound settings, and access other functions.

- 1 Press **⬆️** (Home) .
↳ The menu screen is displayed.

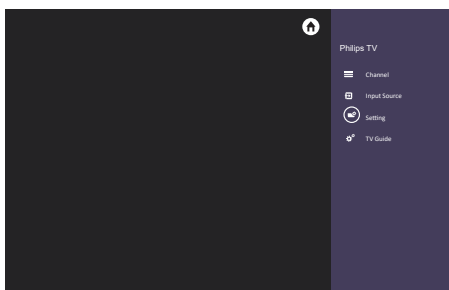

- 2 Select [Setting].
- 3 Press **▲▼◀▶** to select from the following options:
 - [PICTURE / [SOUND] / [TV] (only shown in TV mode) / [SETUP] / [Child Lock] / [HDMI CEC].
- 4 Press OK to confirm.
- 5 Press **⬆️** (Home) to exit or return to the previous menu.

Changing the picture and sound settings

You can change the picture and sound settings to suit your preferences. You can use the preset settings or manually adjust the settings.

Adjusting the picture settings

- 1 Press **⬆️** (Home) and select [Setting] to enter the [Setting] menu. Then select [PICTURE].
- 2 Press **▲▼◀▶** to select/adjust the settings:
 - [Picture Mode]:
 - [Vivid]: increases the contrast and sharpness of the picture.
 - [Standard]: standard picture settings. This option is recommended for home entertainment use.
 - [Nature]: increases the softness of the picture.
 - [Personal]: you can customise your settings with this option.
 - [Contrast]: adjusts the intensity and detail of bright areas, while dark areas remain unchanged (the adjustments made can only be saved in personal settings).
 - [Brightness]: adjusts the intensity and detail of dark areas (the adjustments made can only be saved in personal settings).
 - [Colour]: adjusts the colour saturation (the adjustments made can only be saved in personal settings).
 - [Tint]: adjusts the level of green (this option only appears when using the NTSC system).
 - [Sharpness]: adjusts the sharpness of the image (the adjustments made can only be saved in personal settings).
 - [Colour Temp]:
 - [Cold]: gives a bluish-white hue.
 - [Normal]: gives a white hue. Users can customise the white hue when in PC mode.
 - [Warm]: gives a reddish-white hue.

- **[Aspect Ratio]**: adjusts the screen aspect ratio.
- **[Noise Reduction]**: filters and eliminates signal noise in the image.
- **[HDMI Mode]**: selects the HDMI mode.



Note

- Options may vary for pictures from different sources.

Adjusting the sound settings

- 1 Press **▲** (Home) and select **[Setting]** to enter the **[Setting]** menu. Select **[SOUND]**.
- 2 Press **▲▼◀▶** to select and adjust the settings:
 - **[Sound Mode]**:
 - **[Standard]**: gives balanced, outstanding sound performance in the treble, mid and bass ranges.
 - **[Music]**: enhances treble and bass, delivering bright, clear, pure sound for piano or orchestral instrument performances.
 - **[Movie]**: enhances film sound effects, allowing you to enjoy a home cinema-like effect.
 - **[Sports]**: enhances the smoothness of the sound output, creating a softer sound.
 - **[Personal]**: provides users with customisation functions so that all sound effect parameters are optimised to create the best possible experience.
 - **[Treble]**: adjusts the treble level (the adjustments made can only be saved in personal settings).

- **[Bass]**: adjusts the base level (the adjustments made can only be saved in personal settings).
- **[Balance]**: adjusts the balance of the left and right speakers.
- **[Auto Volume Level]**: turns automatic volume adjustment on when switching channels.
- **[SPDIF Mode]**: selects the coaxial output mode.
- **[Audio Delay]**: delays the sound output.
- **[AD Switch]**: Control the way your TV outputs through its digital audio output port.

Function settings

- 1 Press **▲** (Home) and select **[Setting]** to enter the **[Setting]** menu. Then select **[SETUP]**.
- 2 Press **▲▼◀▶** to select and adjust the settings:
 - **[Language]**: adjusts the language settings of the TV.
 - **[TT Language]**: selects the Teletext language.
 - **[Audio Language]**: selects the desired language when watching digital broadcasting containing several voice languages.
 - **[Subtitle Language]**: sets the subtitles language. If none of the preferred subtitle languages are available, you can select another subtitle language if available.
 - **[Hearing Impaired]**: some digital TV programmes broadcast special audio and subtitles adapted for the hard of hearing or deaf people.
 - **[PVR File System]**: before carrying out PVR operations, the USB flash drive must be formatted and memory space allocated.
 - **[Blue Screen]**: sets the colour of the screen when the TV receives

no signal (when the TV signal is not functioning).

- **[First Time Installation]**: selects to start the setup wizard.
- **[Reset TV]**: restores the default settings (excluding password settings and channel information).
- **[Software Update (USB)]**: checks the current software version.
- **[Environment]**: selects customer or shopping.
- **[Clock]**: selects to set the clock.
- **[Time Zone]**: selects the time zone of your country.
- **[Sleep Timer]**: sets when the TV automatically enters standby mode.
- **[Auto Standby]**: sets how long the TV must be idle for before switching off automatically (not applicable to PC mode).
- **[OSD Timer]**: sets how long the menu is displayed.

Summary of aspect ratio

The following aspect ratios can be configured.

Note

- Some picture settings may be unavailable due to differences between picture signal formats.



[4:3]: the normal standard format.



[16:9]: adjusts the normal standard ratio to a widescreen format.

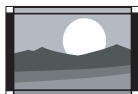

[Zoom 1]: horizontal scaling for the widescreen picture format. When this format is used, the left and right of the frame will be partially cut off.



[Zoom 2]: adjusts the standard ratio to a widescreen format (only 16:9, 4:3 and Point to Point options are available in PC mode).

Using the timer

You can set the timer to switch the TV to standby mode at a set time.

Tip

- Set the sleep timer before using the timer function.

Setting the sleep timer

Tip

- You can turn the TV off in advance or reset the sleep timer when the timer is up.

- 1 Press **⏠** (Home) and select **[Setting]** to enter the **[Setting]** menu. Then select **[SETUP]**.

- 2 Press ▲▼◀▶ to select [Sleep Timer].
- 3 Press ▲▼ to select a time for the sleep timer to switch the TV off.
↳ The longest time that the sleep timer can be set for is 240 minutes.

Child lock settings

By locking the TV, you can prevent children from watching specific programmes or channels.

Setting or changing your password

- 1 Press **Home** and select [Setting] to enter the [Setting] menu. Then select [Child Lock].
- 2 Press ▲▼◀▶ to select [Set Password].:
- 3 Enter the password using the numeric buttons on the remote control.

Locking channels

- 1 Press **Home** and select [Setting] to enter the [Setting] menu. Then select [Child Lock].
- 2 Press ▲▼◀▶ to select [Channel Lock].
- 3 Select the channel you want to lock or unlock.
- 4 A locked channel is marked with a lock icon.

Setting the parental guidance

To prevent children from watching a programme not suitable for their age, you can set a minimum age to watch rated programmes.

Setting the key lock

To prevent children from accessing the keypad of the TV, you can set the key lock to On.

Note

- If you go to a locked channel, you will be prompted to enter the password.
- The default password is '0000'.

Playing multimedia files from USB devices

You can play photo, music, movies or text files stored on a USB storage device on your TV.

- Supported storage devices: USB (only FAT or FAT 32 USB storage devices are supported)
- Supported multimedia file formats:
 - Images: JPEG
 - Audio: MP3
 - Video: MPEG 2/MPEG 4, H.264
 - Documents: TXT

Note

- TP Vision assumes no responsibility if a USB storage device is not supported, or if the data on the device is damaged or lost.

Viewing photos and text files and playing audio and video files

- 1 Turn the TV on.
- 2 Connect the USB storage device to the USB port on the side of the TV.
- 3 Press **SOURCES**.
- 4 Select [Media] and press OK.
↳ The USB browser will open.

Viewing photos

- 1 Select the photo within the USB browser and press **OK**. The photo will be enlarged to fill the screen.

Starting slide shows

- 1 Select a photo or folder and then press **OK**. The photo will be enlarged to fill the screen.
- 2 Press **▶** to start the slide show.
↳ The slide show will start playing from the selected photo.

Listening to music

- 1 In the USB browser, select a song or album. Then press **OK** to begin playing.

Watching movies

- 1 Select the video file in the USB browser, then press **OK** to play the video.
- 2 Use the on-screen control panel to control the video.

Viewing text files

- 1 Select the text file in the USB browser, then press **OK** to view the document.

Removing USB storage devices



Note

- Follow the steps below to avoid damaging the USB storage device.

- 1 Hold down **↵** to exit the USB browser.
- 2 Wait around 5 minutes before removing the USB storage device.

Updating the TV software

Philips constantly strives to improve its products, and so we recommend that you update your TV software whenever an update is released. Visit www.philips.com/TVsupport to check whether updates are available.

Restoring factory settings

You can restore the default picture and sound settings for your TV without affecting the saved channel set up.

- 1 Press **⬆** (**Home**) and select **[Setting]** to enter the **[Setting]** menu
- 2 Press **▲▼◀▶** Then select **[SETUP] > [Reset TV]**.

6 Setting up channels

This chapter explains how to reconfigure and fine-tune channels.

Setting up channels automatically

This option automatically finds and saves channels.

- 1 Press **Home** and select **[Setting]** to enter the **[TV]** menu
- 2 Select **[Auto Tuning]**.
- 3 Press **OK**.
 - ↳ The TV will start searching for channels automatically.

Editing channel list

- 1 Press **Home** and select **[Setting]** to enter the **[TV]** menu.
- 2 Select **[Programme Edit]**.
- 3 Press **▲▼** to select the channel.
- 4 Follow the on-screen instructions.
 - **Delete:** Press the **Red** key to delete the programme in the list.
 - **Move:** Press the **Yellow** key to move the channel in the list.
 - **Skip:** Press the **Blue** key to skip the selected channel.

TV Guide

- 1 Press **TV GUIDE** on the remote control to access TV program guide list (It is available only in DTV mode). In this program guide list, press **▲▼** to select the current time and date, and then press **◀▶** to view all programs information in the next 7 days of the future.

- 2 Press **◀▶** to select Channel in the top bar of guide list, then press **▲▼** to view a program information in the next 7 days of the future. Focus on the Channel bar you can press **◀▶** to view the other programs information.
- 3 Follow the on-screen instructions.

7 Connecting the TV

This section explains how to connect devices with different connectors.

Note

- You can use different connection types to connect devices to the TV.

Down ports

① AV input

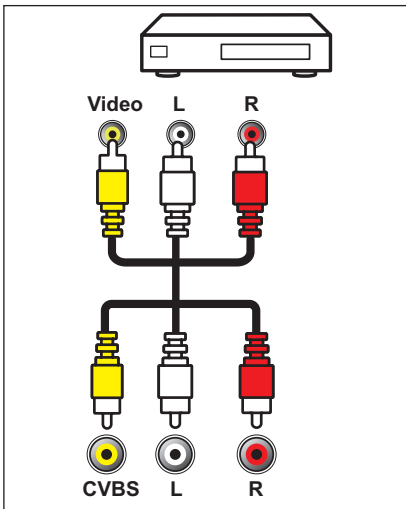

② DIGITAL AUDIO OUT

Digital audio signal output for digital audio equipment.

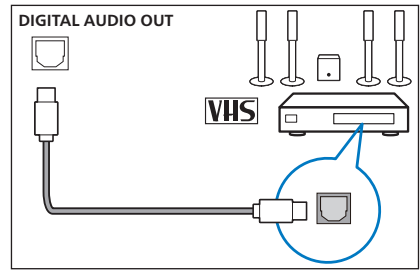

③ Antenna/cable TV

Input for an antenna, cable or satellite signal.

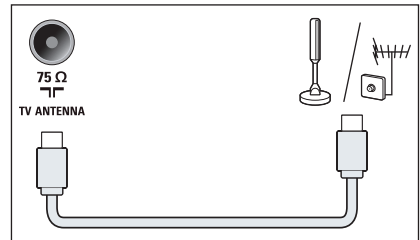

Side ports

① HDMI 1(ARC) /HDMI 2

Digital audio and video input from high definition devices such as Blu-ray players.

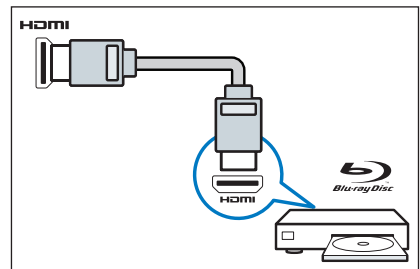

② USB

Data input from a USB storage device.

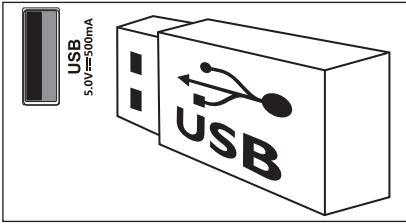

Press **⏠ (Home)** > **[Sound]** > **[TV Speakers]** > **[off]**.

Note

- Headphones can only be used as a low-power audio output. Do not connect high-power active devices (such as high-power active speakers).

③ Component signal input

Audio and video input from DVD players, game consoles and other analog or digital devices

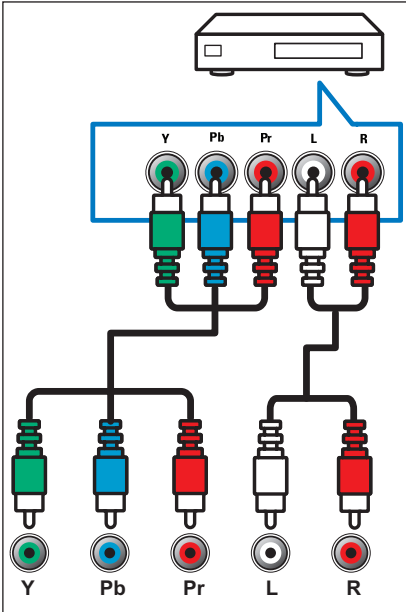

Connecting to a computer

Before connecting a computer to the TV:

- Set the computer screen refresh rate to 60 Hz.
- Select a supported screen resolution on the computer.

Connect to the computer using one of the following connections:

Note

- A separate audio cable is required when connecting via DVI.

④ Headphones

Stereo sound output for headphones.

If you want to use headphone only, please turn off TV Speakers in advance.

HDMI cable

- 1 Set the resolution of the computer display to 480p/576p/720p/1080p
- 2 Press **⏠ (Home)** and select **[Setting]** to enter the **[Setting]** menu.
- 3 Select **[PICTURE]** > **[HDMI Mode]**, and set the HDMI display mode to graphics or video.
- 4 Adjust the picture format to achieve the best display results.
 - Press **⏠ (Home)** and select **[Setting]** to enter the **[Setting]** menu.
 - Select **[SETUP]** > **[Aspect Ratio]**.
 - Select an aspect ratio.
 - Press **OK** to confirm.

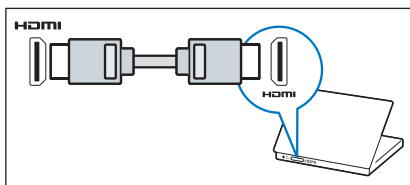

Using HDMI CEC

Making full use of your HDMI-CEC compatible devices can enhance control features to achieve the best possible results. HDMI-CEC compatible devices connected through the HDMI connector can be controlled by a TV remote control.

To enable HDMI CEC, you will need to:

- Connect two or more HDMI-CEC compatible devices using HDMI connections.
- Make sure that each HDMI-CEC compatible device is operating normally.
- Switch to HDMI CEC.

Note

- HDMI CEC compatible devices must be switched on and selected as a signal source.
- Philips does not guarantee 100% interoperability with all HDMI-CEC devices.

Enabling or disabling HDMI CEC

Once an HDMI-CEC compatible device has been switched on, the TV will automatically turn on and switch to the correct signal source.

Note

- Do not enable this function if you would prefer not to use HDMI CEC.

- 1 Press **Home** and select **[Setting]** to enter the **[Setting]** menu.
- 2 Select **[HDMI CEC]**.
- 3 Select **[Off]** or **[On]**, then press **OK**.

Using One-touch Play

- 1 Once HDMI CEC has been enabled, press **play** on the device.
 - ↳ The TV will automatically switch to the correct signal source.

Using One-touch Standby

- 1 Press **(Standby/On)** on the remote control.
 - ↳ The TV and all connected HDMI devices will automatically enter standby mode.

8 Product information

Product information is subject to change without notice. For detailed product information, please visit www.philips.com/TVsupport.

Display resolutions

Computer Formats

- Resolution - refresh rate:
 - 640 x 480 - 60Hz
 - 800 x 600 - 60Hz
 - 1024 x 768 - 60Hz
 - 1360 x 768 - 60Hz
 - 1920 x 1080 - 60Hz
(32 inches TV is not supported)

Video Formats

- Resolution - refresh rate:
 - 480i - 60Hz
 - 480p - 60Hz
 - 576i - 50Hz
 - 576p - 50Hz
 - 720p - 50Hz, 60Hz
 - 1080i - 50Hz, 60Hz
 - 1080p - 50Hz, 60Hz.

Multimedia

- Supported storage devices: USB (only FAT or FAT 32 USB storage devices are supported).
- Compatible multimedia file formats:
 - Image: JPEG
 - Audio: MP3
 - Video: MPEG 2/MPEG 4, H.264
 - Document: TXT

Audio output power

- 32PHT5678: 5W x 2
- 43PFT5678: 8W x 2

Intrinsic resolution

- 32PHT5678: 1366x 768
- 43PFT5678: 1920x 1080

Tuner/reception/transmission

- Aerial input: 75 ohm coaxial (IEC75)
- TV systems: PAL, DVB-T/T2
- Video playback: NTSC, SECAM, PAL

Remote control

- Batteries: 2 x AAA

Power supply

- Mains power: 110-240V, 50-60Hz
- Standby power: ≤ 0.5 W
- Ambient temperature: 5 to 40 degrees Celsius
- Power consumption:
 - 32PHT5678: 50W
 - 43PFT5678: 65W

Supported TV mounts

To mount the TV, please purchase a Philips TV mount or any TV mount compliant with the VESA standard. To prevent damage to cables and connectors, be sure to leave a clearance gap of at least 2.2 inches or 5.5cm between the back of the TV to the wall.



Caution

- Please follow all instructions provided with the TV mount. TP Vision Europe B.V. bears no responsibility for improper TV mounting that results in accident, injury or damage.

Model No.	Required Pixel Pitch (mm)	Required Mounting Screws
32PHT5678	200 x 100	4 x M6 (recommended length: 10 mm)
43PFT5678	200 x 200	4 x M6 (recommended length: 10 mm)

9 Troubleshooting

This section covers common problems and their accompanying solutions.

General issues

The TV cannot be switched on:

- Disconnect the power cable from the power outlet. Wait for one minute before reconnecting it.
- Check that the power cable is securely connected.

The remote control is not working properly:

- Check that the remote control batteries are correctly inserted according to the +/- orientation.
- Replace the remote control batteries if they are flat or weak.
- Clean the remote control and TV sensor lens.

The standby light on the TV is red and blinking:

- Disconnect the power cable from the power outlet. Wait for the TV to cool down before reconnecting the power cable. If the light continues to blink, please contact Philips Customer Care Centre.

You forgot the code to unlock the TV lock feature

- Enter '8888'.

The TV menu is in the wrong language.

- Change the TV menu to your preferred language.

When turning the TV On/Off or to Standby, you hear a creaking sound from the TV chassis:

- No action is required. The creaking sound comes from the normal expansion and contraction of the TV as it cools down and warms up. This does not impact its performance.

Channel issues

Previously installed channels do not appear in the channel list:

- Check that the correct channel list is selected.

Picture issues

The TV is on, but there is no picture:

- Check that the antenna is properly connected to the TV.
- Check that the correct device is selected as the TV source.

There is sound but no picture:

- Check that the picture settings are correctly set.

Poor TV reception from the antenna connection:

- Check that the antenna is properly connected to the TV.
- Loudspeakers, unearthed audio devices, neon lights, high buildings and other large objects can influence reception quality. If possible, try to improve the reception quality by changing the antenna direction or moving devices away from the TV.
- If the reception on one particular channel is poor, please fine tune this channel.

There is poor picture quality from connected devices:

- Check that the devices are connected properly.
- Check that the picture settings are correctly set.

The TV did not save your picture settings:

- Check that the TV location is set to the home setting. This mode offers you the flexibility to change and save settings.

The picture does not fit the screen; it is too big or too small:

- Try using a different picture format.
- The picture position is incorrect:
- Picture signals from some devices may not fit the screen correctly. Please check the signal output of the device.

Sound issues

The pictures are showing but sound quality is poor:

Note

- If no audio signal is detected, the TV automatically switches the audio output off - this does not indicate malfunction.

- Check that all cables are properly connected.
- Check that the volume is not set to 0.
- Check that the sound is not muted.
- Check that the sound settings are correctly set.

The pictures are showing but sound comes from one speaker only:

- Verify that sound balance is set to the centre.

HDMI connection issues

There are problems with HDMI devices:

- Please note that HDCP (High-bandwidth Digital Content Protection) support can delay the time taken for a TV to display content from a HDMI device.
- If the TV does not recognise the HDMI device and no picture is displayed, please try switching the signal source to another device before switching it back again.
- If there are intermittent sound disruptions, please check that output settings from the HDMI device are correct.

- If you are using a HDMI to DVI adapter or cable, please check if the audio cable that comes with the product is connected to AUDIO (only for mini jacks).

Computer connection issues

The computer display on the TV is not stable:

- Check that your PC uses the supported resolution and refresh rate.
- Set the TV picture format to unscaled.

Contact us

If you cannot resolve your problem, please refer to the FAQs for this model at

www.philips.com/TVsupport.

If the problem remains unresolved, please contact your local Philips Customer Service Centre.



Warning

- Do not attempt to repair the TV yourself. This may cause severe injury, irreparable damage to your TV or void your warranty.



Note

- Please make a note of your TV model and serial number before you contact Philips Customer Service Centre. These numbers are printed on the back/bottom of the TV and on the packaging.

10 Warranty

English
Warranty

Indonesia
Jaminan

简体中文
保修

Malay
Waranti

Deutsch
Garantie

ไทย
การรับประกัน

繁體中文
保養

Français
Garantie

Tiếng Việt
Bảo hành

العربية
الضمان

English - Guarantee

Dear Customer,
Thank you for purchasing this Philips product. For the Philips warranty applicable to this product, we refer you to the Philips website www.philips.com/guarantee. In the event you do not have an internet connection, please contact your local Philips Consumer Care Centre. Contact details are given in the Consumer Care Centres list hereafter:

Deutsch - Garantie

Sehr geehrter Kunde, wir beglückwünschen Sie zu Ihrer Entscheidung für dieses Produkt von Philips. Nähere Informationen zu der für dieses Produkt geltenden Philips Garantie finden Sie im Internet unter www.philips.com/guarantee. Die durch Philips gewährte Garantie beeinträchtigt in keiner Weise Ihre gesetzlichen Rechte. Sofern Sie keinen Zugang zum Internet haben, wenden Sie sich bitte an Ihr Philips Info-Center vor Ort. Die entsprechenden Kontaktdaten entnehmen Sie bitte der nachstehenden Liste.

Français - Garantie

Cher client,
Merci d'avoir acheté ce produit Philips. Pour connaître les conditions de garantie Philips applicables à ce produit, reportez-vous à la page www.philips.com/guarantee. Si vous ne possédez pas de connexion Internet, contactez votre Service Consommateurs Philips local. Vous trouverez les coordonnées de tous les Services Consommateurs dans la liste ci-après. Ces informations étaient correctes à la date d'impression. Pour des informations à jour, consultez la page www.philips.com/support.

Indonesia - Jaminan

Pelanggan yang terhormat,
Terima kasih telah membeli produk Philips. Untuk mendapatkan jaminan produk ini, kunjungi situs Web Philips di www.philips.com/guarantee. Jika Anda tidak memiliki sambungan Internet, hubungi Pusat Layanan Pelanggan Philips setempat. Rincian kontak tercantum dalam daftar Pusat Layanan Pelanggan.

ไทย - การรับประกัน

เรียนลูกค้า
ขอขอบคุณที่เลือกซื้อผลิตภัณฑ์ของ Philips สำหรับการรับประกันที่มีผลบังคับใช้กับผลิตภัณฑ์นี้ โปรดอ้างอิงเว็บไซต์ของ Philips www.philips.com/guarantee ในกรณีที่คุณไม่มีอินเทอร์เน็ต โปรดติดต่อศูนย์บริการลูกค้า Philips ประจำท้องถิ่นของคุณ รายละเอียดการติดต่อจะแสดงอยู่ในรายชื่อศูนย์บริการลูกค้าต่อไป

Tiếng Việt - Bảo hành

Kính gửi Quý khách hàng,
Cảm ơn quý vị đã mua sản phẩm Philips này. Để biết bảo hành của Philips có thể áp dụng cho sản phẩm này, chúng tôi xin giới thiệu trang web của Philips www.philips.com/guarantee. Trong trường hợp quý vị không có kết nối internet, vui lòng liên hệ với Trung tâm Chăm sóc Khách hàng của Philips tại địa phương. Chi tiết liên hệ được cung cấp trong danh sách Trung tâm Chăm sóc Khách hàng sau đây.

简体中文 - 保证

尊敬的客户：
感谢您购买此 Philips 产品。有关适用于此产品的 Philips 保修信息，建议您访问 Philips 网站：www.philips.com/guarantee。如果您无法访问 Internet，请联系您当地的 Philips 客户服务中心。将来，我们会在客户服务中心列表中提供详细联系信息。

繁體中文 - 保證

親愛的客戶，您好：
多謝您購買本飛利浦產品。有關適用於本產品的飛利浦保養詳情，請瀏覽飛利浦網站：www.philips.com/guarantee。如您未能連線至互聯網，請與您當地的飛利浦消費者保養中心聯絡。聯絡詳情已詳列於之後的消費者保養中心清單中。

**العربية
الضمان**

عزيزي العميل،
شكرا لكم على شراء هذا المنتج من Philips. لمعرفة شروط ضمان Philips الذي ينطبق على هذا المنتج، راجع موقع www.philips.com/guarantee. في حال لم يكن لديك اتصالاً بالإنترنت، يرجى الاتصال برقم مركز خدمة العملاء المحلي لشركة Philips. يمكن معرفة تفاصيل الاتصال من قائمة مراكز خدمة العملاء فيما يلي.

Inggeris-Jaminan

Pelanggan yang dihormati,
Terima kasih kerana membeli produk Philips. Bagi waranti Philips yang terpakai untuk produk ini, kami merujuk anda kepada laman web Philips www.philips.com/guarantee. Sekiranya anda tidak mempunyai sambungan Internet, sila hubungi Pusat Layanan Pelanggan Philips tempatan anda. Butiran kenalan diberikan dalam senarai Pusat Layanan Pelanggan selepas ini.



User Manual



FAQ



Chat



Forum



Call



Email



Warranty

www.philips.com/support

Australia
1300 998 851

Indonesia
0800-1-822822

Philippines/Pilipinas
632 84204970

Malaysia
1800 220 180

Singapore/新加坡
65 6286 7333

Thailand/ประเทศไทย
0-2746-5431



All registered and unregistered trademarks are property of their respective owners. Specification are subject to change without notice.

Philips and the Philips' shield emblem are trademarks of Koninklijke Philips N.V. and are used under license from Koninklijke Philips N.V.

This product has been manufactured by and is sold under the responsibility of TP Vision Europe B.V., and TP Vision Europe B.V. is the warrantor in relation to this product.

2023 © TP Vision Europe B.V. All rights reserved.

www.philips.com/welcome