

50PUD7908  
55PUD7908  
65PUD7908  
75PUD7908

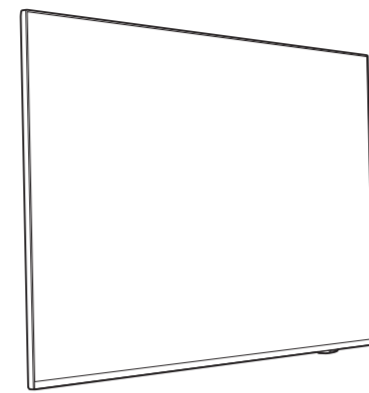

50"/55"/65"

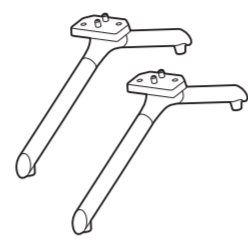

75"

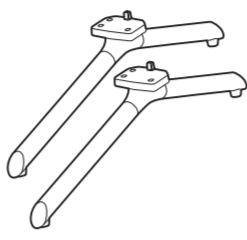

50"/55"/65" (M4xL20) : x4  
75" (M5xL22) : x6

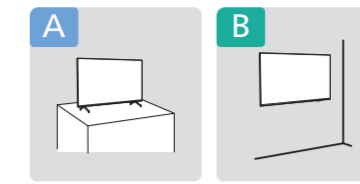
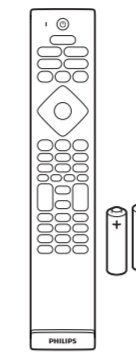
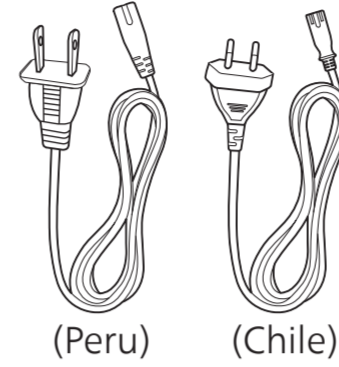

Registre su producto y obtenga asistencia en [www.philips.com/TVsupport](http://www.philips.com/TVsupport)

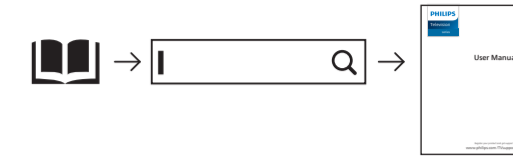

#### A 1a 50"/55"

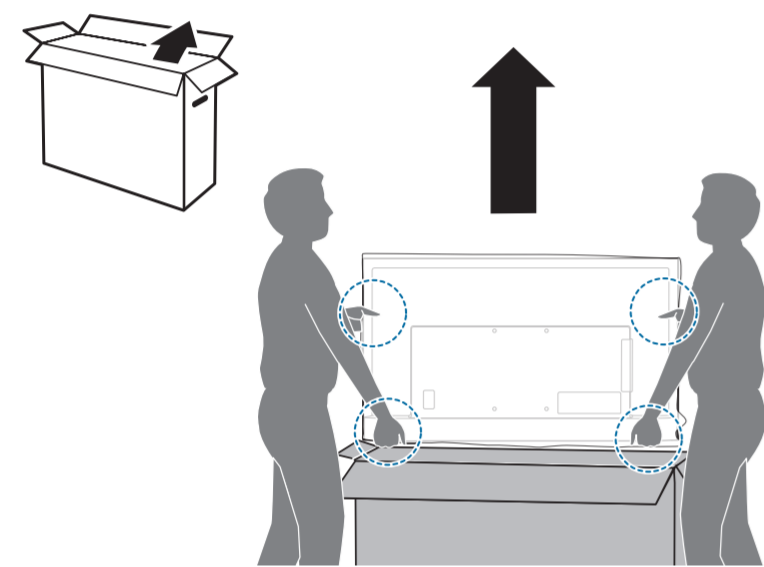

#### 1b 65"/75"

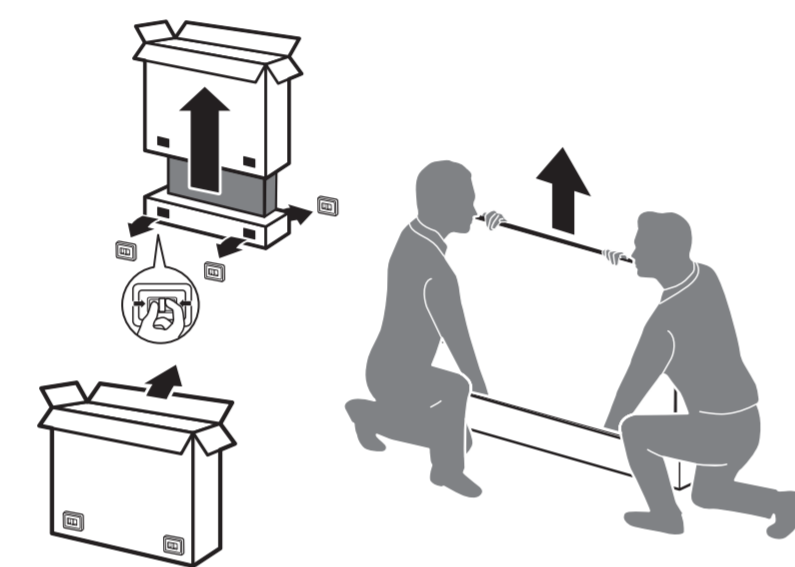

#### 2

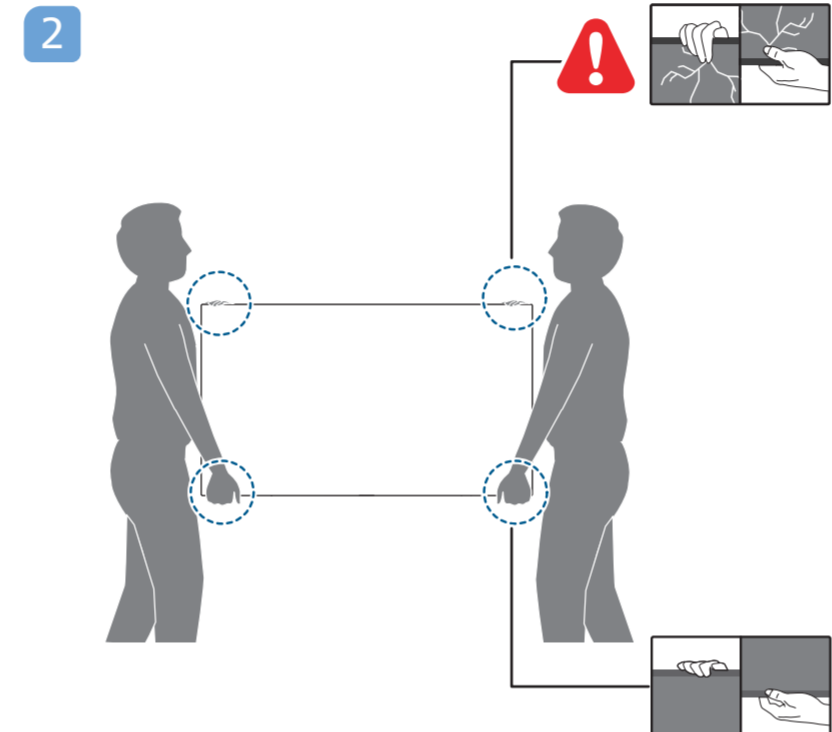

#### 3

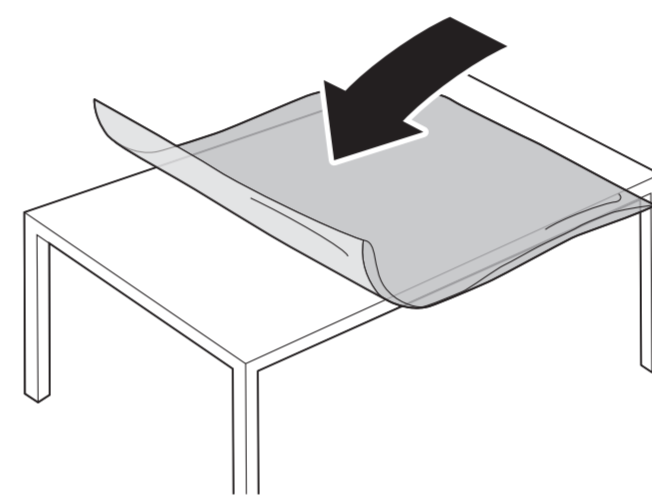

#### B

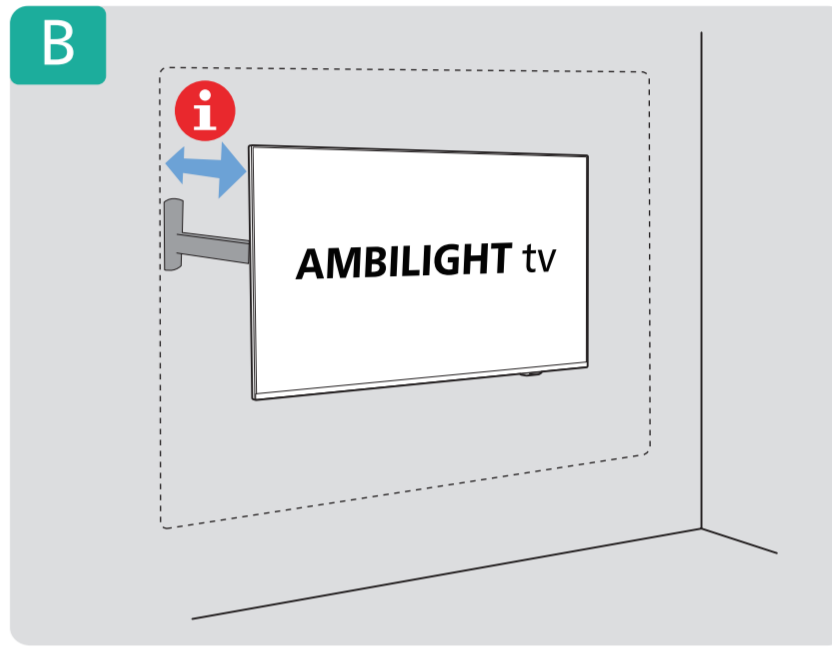

#### 4

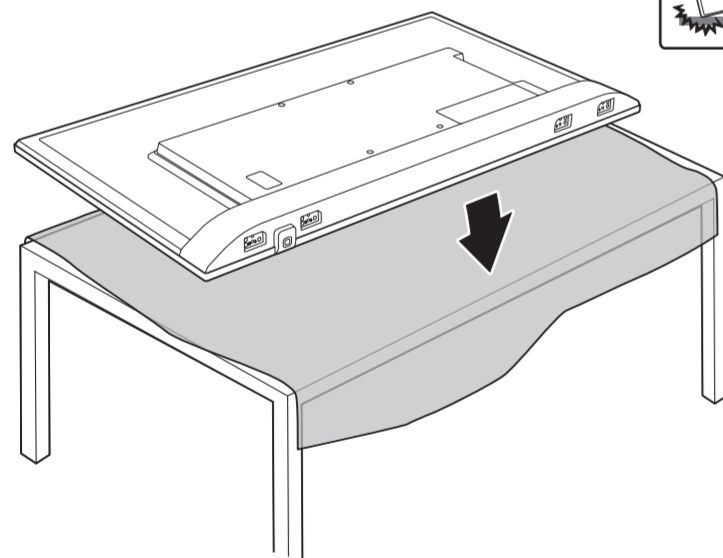
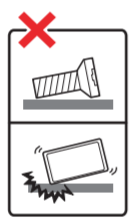

#### 5

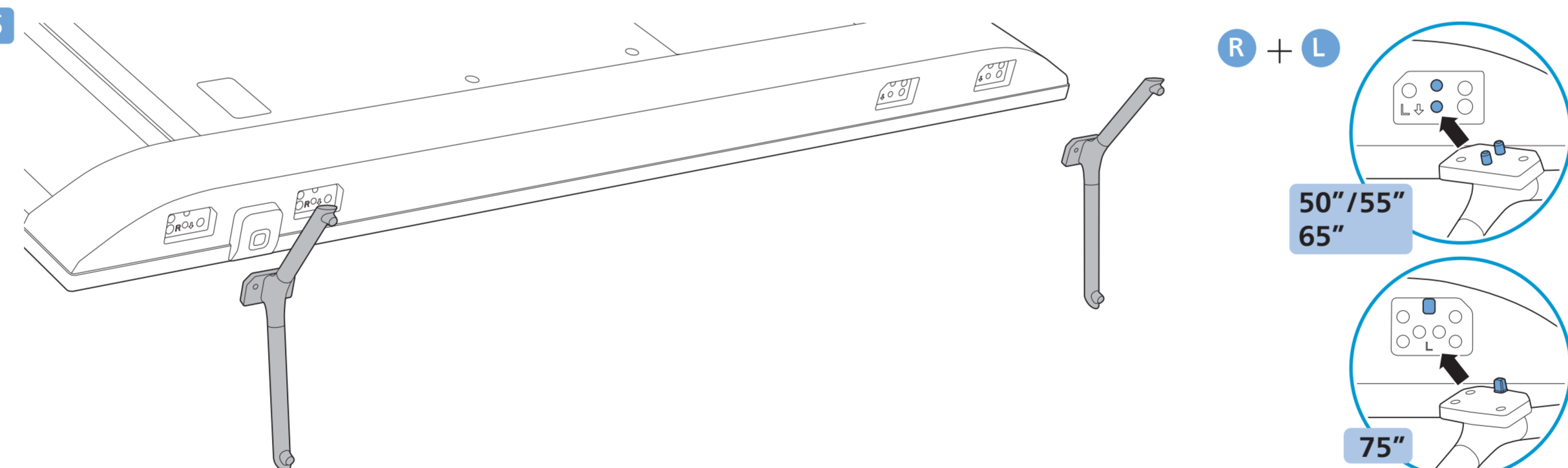

#### 1 50"

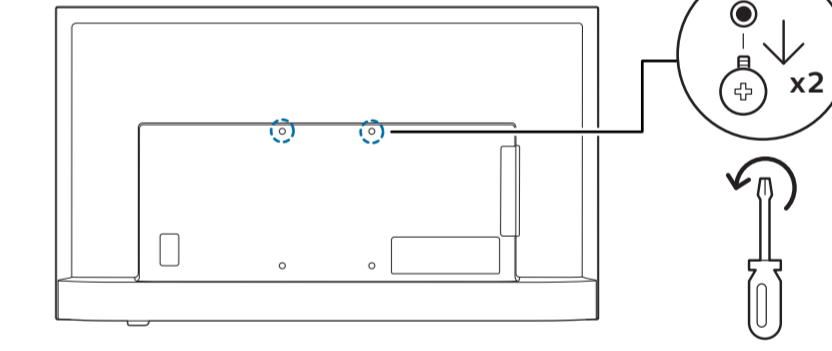

#### 2 Dimensiones para montaje en pared (x, y)

- 50" 200x300mm M6 (L: 10mm~16mm) 126 cm
- 55" 200x300mm M6 (L: 10mm~16mm) 139 cm
- 65" 300x300mm M6 (L: 12mm~20mm) 164 cm
- 75" 300x300mm M8 (L: 12mm~25mm) 189 cm

#### 6

50"

55"/65"/75"

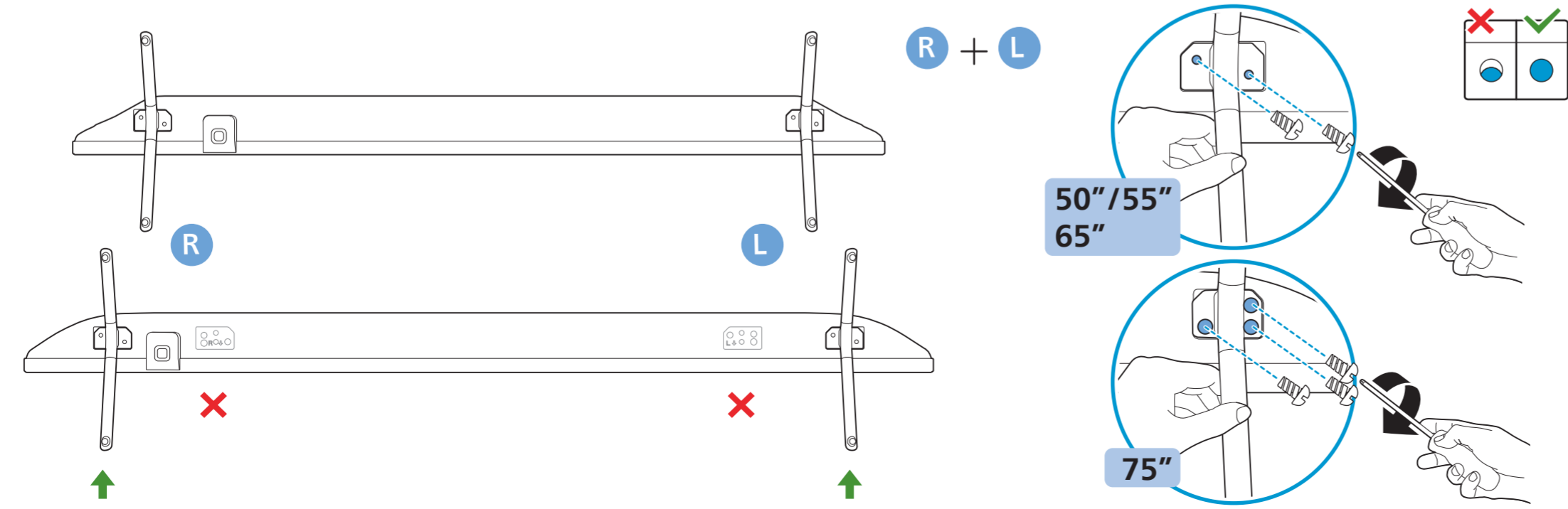

#### 7

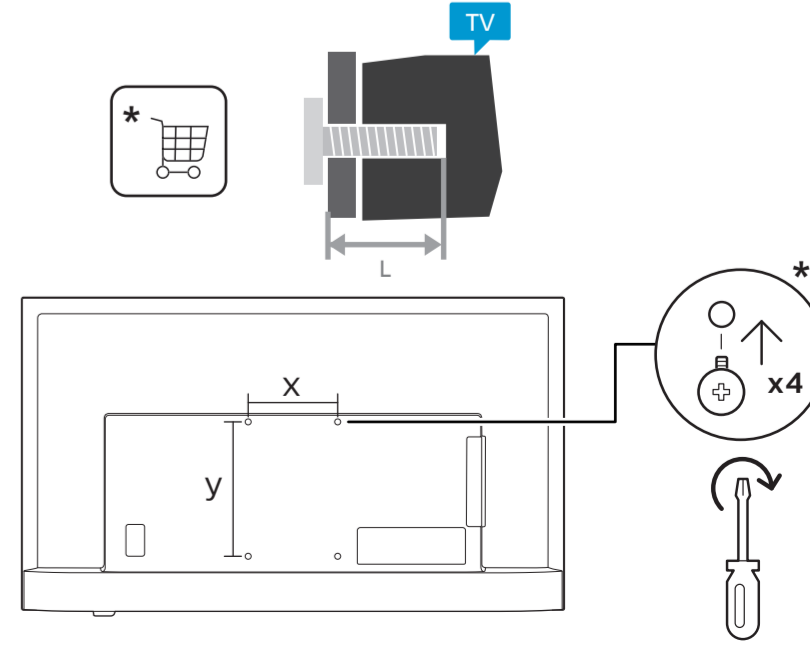
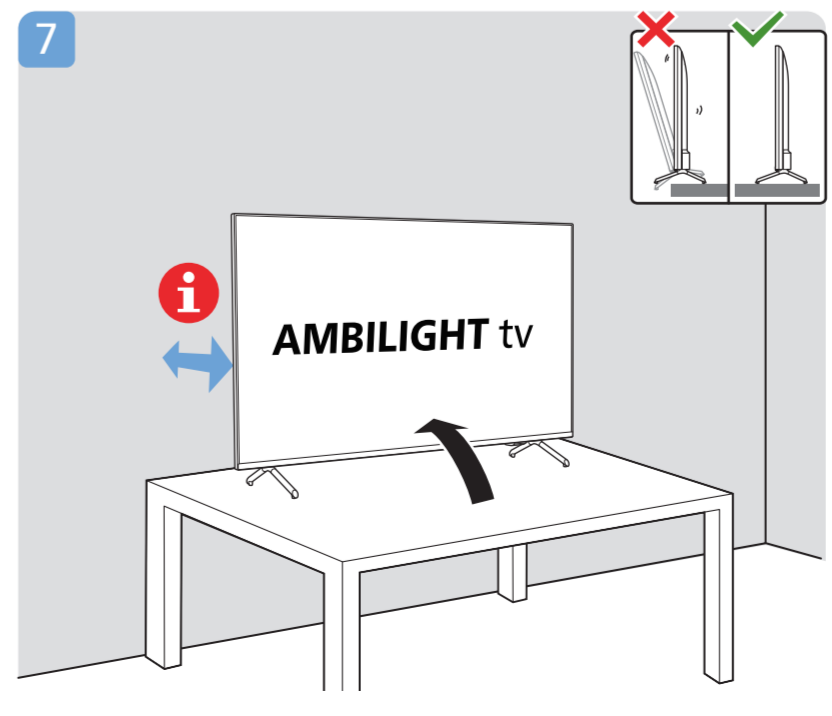



1

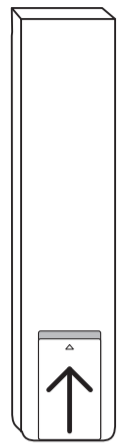

2

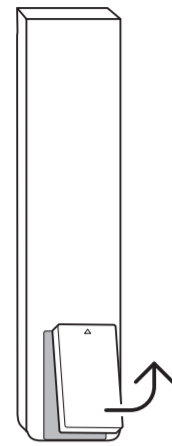

3

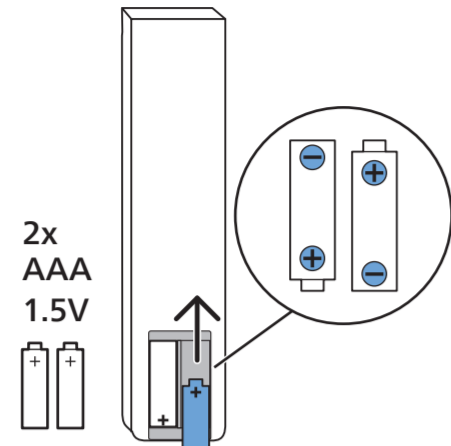

4



5

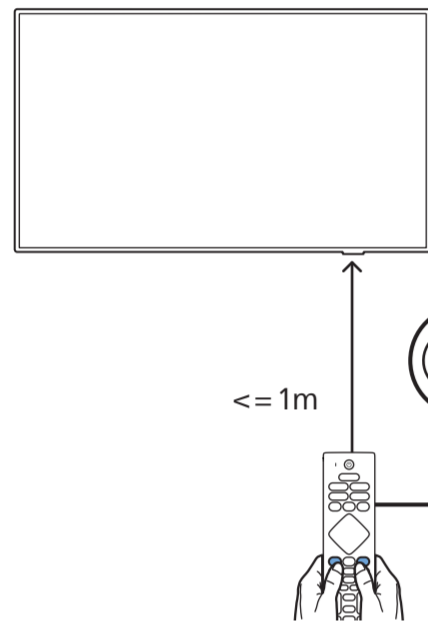

3 sec

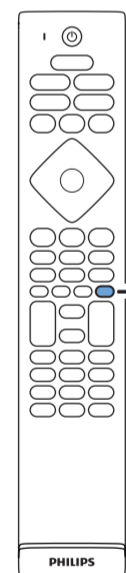
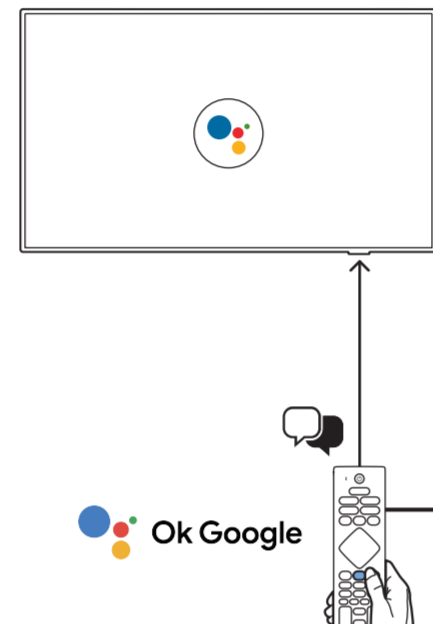
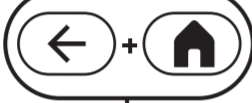

English Read the safety instructions.  
Español Lea la información de seguridad.

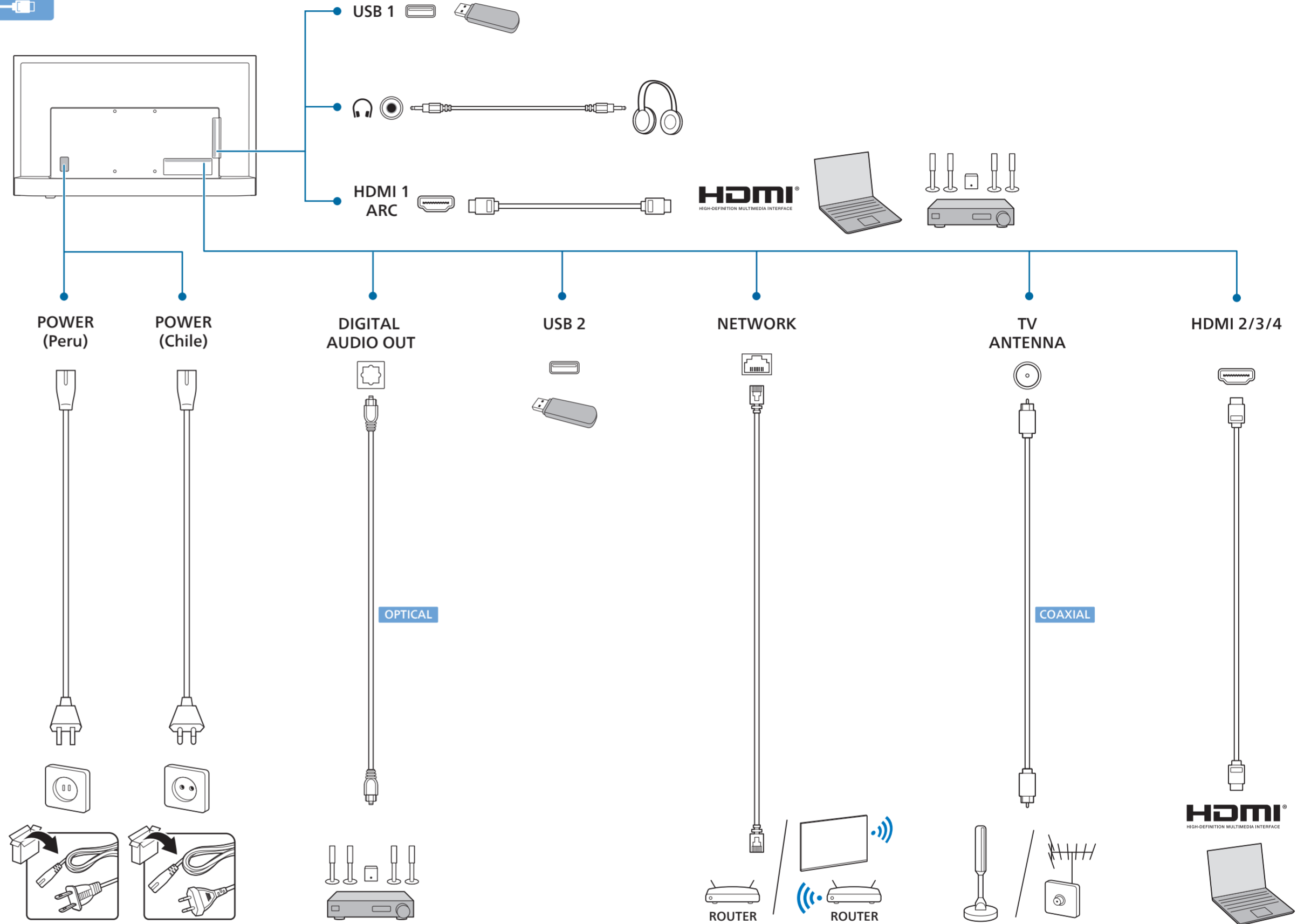
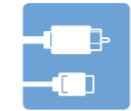

### AMBILIGHT tv

Muro

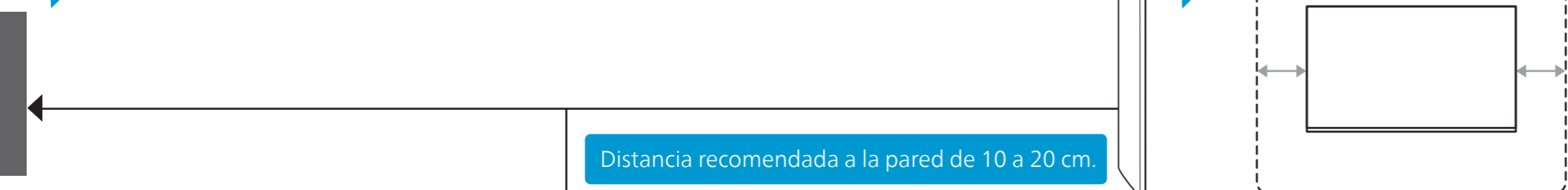

Distancia recomendada a la pared de 10 a 20 cm.

0cm 1 2 3 4 5 6 7 8 9 10 11 12 13 14 15 16 17 18 19 20 21 22 23 24 25 26 27

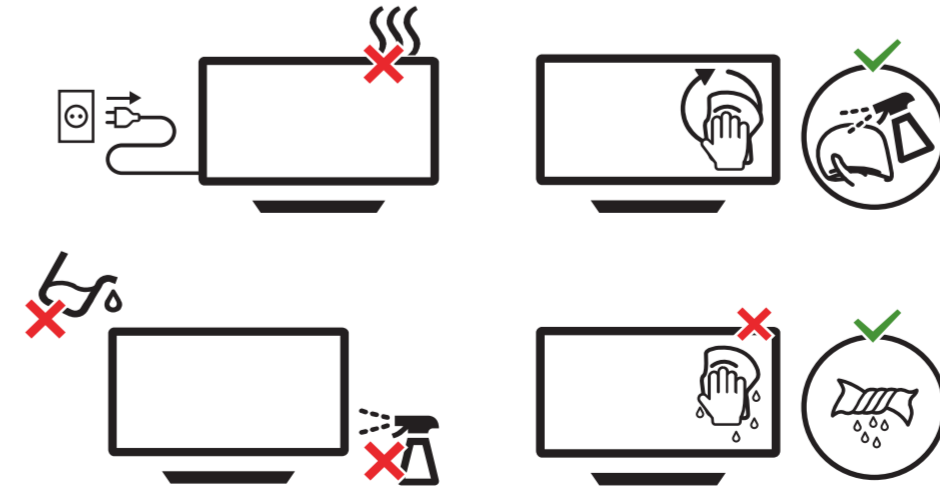

All registered and unregistered trademarks are property of their respective owners. Specifications are subject to change without notice. Philips and the Philips' shield emblem are trademarks of Koninklijke Philips N.V. and are used under license from Koninklijke Philips N.V. This product has been manufactured by and is sold under the responsibility of TP Vision Europe B.V. and TP Vision Europe B.V. is the warrantor in relation to this product. 2023 © TP Vision Europe B.V. All rights reserved. www.philips.com/welcome