

Register your product and get support at
www.philips.com/welcome



22PFL4556/V7
32PFL4356/V7
32PFL4556/V7

EN

User manual

PHILIPS

Contents

1 Notice 2

2 Important 3

3 Your TV 5

4 Remote Control Functions 7

5 Use your TV 8

6 FAQ 12

7 Other Information 13

8 Product information 14

1 Notice

Pixel characteristics

This LCD/LED product has a high number of colour pixels. Although it has effective pixels of 99.999% or more, black dots or bright points of light (red, green or blue) may appear constantly on the screen. This is a structural property of the display (within common industry standards) and is not a malfunction.

Warranty

No components are user serviceable. Do not open or remove covers to the inside of the product. Repairs may only be done by Philips Service Centres and official repair shops. Failure to do so shall void any warranty, stated or implied.

Any operation expressly prohibited in this manual, any adjustments, or assembly procedures not recommended or authorised in this manual, shall void the warranty.

2 Important

Read and understand all instructions before you use your TV. If damage is caused by failure to follow instructions, the warranty does not apply.

Safety

Risk of electric shock or fire !

- Never expose the TV to rain or water. Never place liquid containers, such as vases, near the TV. If liquids are spilt on or into the TV, disconnect the TV from the power outlet immediately. Contact Philips Consumer Care to have the TV checked before use.
- Never place the TV, remote control or batteries near naked flames or other heat sources, including direct sunlight. To prevent the spread of fire, keep candles or other flames away from the TV, remote control and batteries at all times.



- Never insert objects into the ventilation slots or other openings on the TV.
- When the TV is swiveled ensure that no strain is exerted on the power cord. Strain on the power cord can loosen connections and cause arcing.

Risk of electric shock or fire !

- Never expose the remote control or batteries to rain, water or excessive heat.
- Avoid force coming on to power plugs. Loose power plugs can cause arcing or fire.

Risk of injury or damage to the TV!

- Two people are required to lift and carry a TV that weights more than 25 kg.

Risk of swallowing batteries!

- When stand mounting the TV, use only the supplied stand. Secure the stand to the TV tightly. Place the TV on a flat, level surface that can support the combined weight of the TV and the stand.
- When wall mounting the TV, use only a wall mount that can support the weight of the TV. Secure the wall mount to a wall that can support the combined weight of the TV and wall mount. PE Electronics Ltd bears no responsibility for improper wall mounting that result in accident, injury or damage.

Risk of injury to children!

Follow these precautions to prevent the TV from toppling over and causing injury to children:

- Never place the TV on a surface covered by a cloth or other material that can be pulled away.
- Ensure that no part of the TV hangs over the edge of the surface.
- Never place the TV on tall furniture (such as a bookcase) without anchoring both the furniture and TV to the wall or a suitable support.
- Educate children about the dangers of climbing on furniture to reach the TV.

Risk of overheating!

- Never install the TV in a confined space. Always leave a space of at least 4 inches or 10 cm around the TV for ventilation. Ensure curtains or other objects never cover the ventilation slots on the TV.

Risk of damage to the TV!

- Before you connect the TV to the power outlet, ensure that the power voltage matches the value printed on the back of the TV. Never connect the TV to the power outlet if the voltage is different.

Risk of injury, fire or power cord damage!

- Never place the TV or any objects on the power cord.
- To disconnect the TV power cord easily from the power outlet, ensure that you have full access to the power cord at all times.

- When you disconnect the power cord, always pull the plug, never the cable.
- Disconnect the TV from the power outlet and antenna before lightning storms. During lightning storms, never touch any part of the TV, power cord or antenna cable.

Risk of hearing damage!

- Avoid using earphones or headphones at high volumes or for prolonged periods of time.

Low temperatures

- If the TV is transported in temperatures below 5°C, unpack the TV and wait until the TV temperature matches room temperature before connecting the TV to the power outlet.

- Risk of damage to the TV screen!
Never touch, push, rub or strike the screen with any object.
- To avoid deformations and colour fading, wipe off water drops as soon as possible.

Disposal of your old product and batteries



Your product is designed and manufactured with high quality materials and components, which can be recycled and reused.

Screen care

- Avoid stationary images as much as possible. Stationary images are images that remain on-screen for extended periods of time. Examples include: on-screen menus, black bars and time displays. If you must use stationary images, reduce screen contrast and brightness to avoid screen damage.
- Unplug the TV before cleaning.
- Clean the TV and frame with a soft, damp cloth. Never use substances such as alcohol, chemicals or household cleaners on the TV.

3 Your TV

Side controls and indicators (LED 22PFL4556/V7)

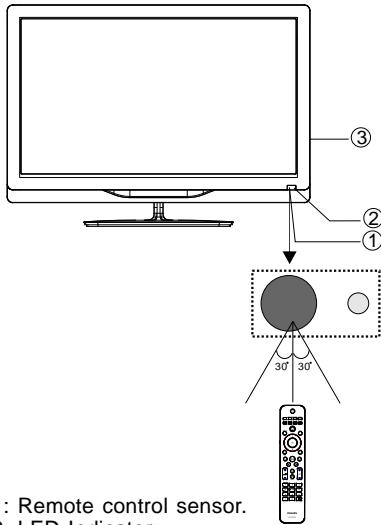

- 1: Remote control sensor.
- 2: LED Indicator:
No light: In Power ON/Power OFF condition.
Red light: In Standby condition.
- 3: Key board

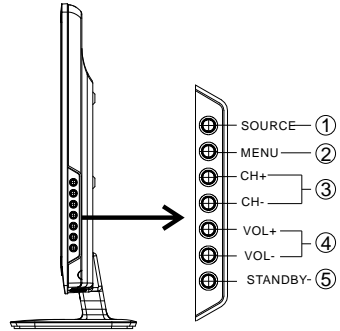

- 1. **SOURCE:** Display source menu.
- 2. **MENU:** Display main MENU.
- 3. **CH+/CH-:** In TV mode, press "CH+" or "CH-" to change the channel up and down. In MENU mode, press "CH+" or "CH-" to select items. In standby mode, press "CH+" or "CH-" to turn on the TV.
- 4. **VOL+/VOL-:** Adjust sound level. In MENU mode, press "VOL+" or "VOL-" to adjust the item that you selected.
- 5. **STANDBY:** Press this button to turn the TV ON from STANDBY mode. Press it again to turn the set back to STANDBY.

Sockets

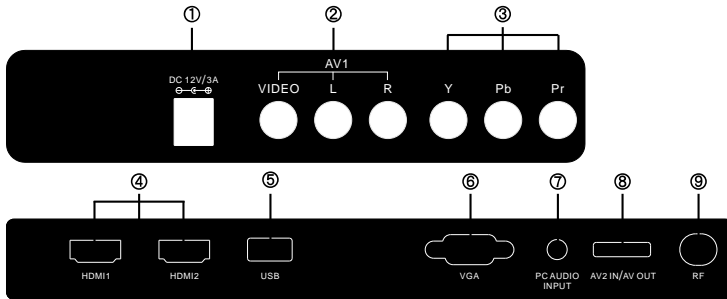

- 1. POWER SOCKET
- 2. Composite Video and Audio Input (AV1)
- 3. Component Video (YPbPr) Input
- 4. HDMI Input
- 5. USB
- 6. VGA Port (PC Input)
- 7. PC Audio Input
- 8. AV2 IN/AV OUT
(The socket can be used to connect AV2 IN/AV OUT adapter cable).
Note :When connecting the AV Adapter cable, please make sure the side with triangular mark towards the inside.
- 9. Antenna Socket

Note: 1. Composite video input and component video input share the audio input. Audio Input for Component is Common with AV1 Audio input.
2. When "DVI to HDMI cable" is used, the audio output for DVI needs to be connected to the PC Audio Input.

3 Your TV

Side controls and indicators (LED 32PFL4356/V7 & 32PFL4556/V7)

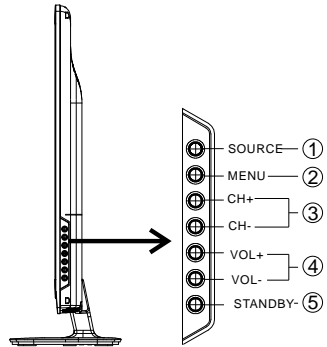
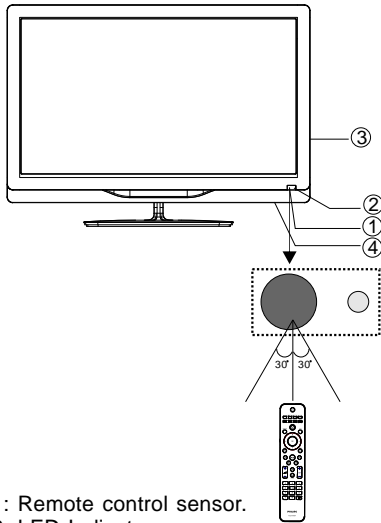

- 1: Remote control sensor.
- 2: LED Indicator:
No light: In Power ON/Power OFF condition.
Red light: In Standby condition.
- 3: Key board
- 4: Main Power Switch (Bottom side).

- 1. **SOURCE**: Display source menu.
- 2. **MENU**: Display main MENU.
- 3. **CH+/CH-**: In TV mode, press "CH+" or "CH-" to change the channel up and down. In MENU mode, press "CH+" or "CH-" to select items. In standby mode, press "CH+" or "CH-" to turn on the TV.
- 4. **VOL+/VOL-**: Adjust sound level. In MENU mode, press "VOL+" or "VOL-" to adjust the item that you selected.
- 5. **STANDBY**: Press this button to turn the TV ON from STANDBY mode. Press it again to turn the set back to STANDBY.

Sockets

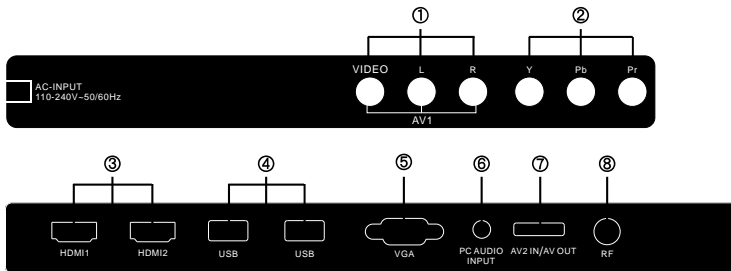

- 1. Composite Video and Audio Input (AV1)
- 2. Component Video (YPbPr) Input
- 3. HDMI Input
- 4. USB
- 5. VGA Port (PC Input)
- 6. PC Audio Input
- 7. AV2 IN/AV OUT
(The socket can be used to connect AV2 IN/AV OUT adapter cable.
Note :When connecting the AV Adapter cable, please make sure the side with triangular mark towards the inside.
- 8. Antenna Socket

Note: 1. Composite video input and component video input share the audio input.
Audio Input for Component is Common with AV1 Audio input.
2. When "DVI to HDMI cable" is used, the audio output for DVI needs to be connected to the PC Audio Input.

4 Remote Control Functions

Note:-Remote Control (Depending on the models) and operation of remote control may be affected by bright artificial light near to the TV.

Most of your television's functions are available via the menus that appear on the screen. The remote control supplied with your set can be used to navigate through the menus and to configure all the general settings.



 (On/Off button) Turns the TV on or off in standby.

TV Access the TV mode.

 **INCR. SURR** Enables Incredible Surround for stereo sources. Enables spatial mode for mono sources.

 **TELETEXT** Toggles teletext on or off.

SOURCE Press to select signal source.

DEMO Toggles the demonstration menu on or off.

SCENEA Deletes the selected file in the playlist.

DUAL I/II Switches Stereo and Nicam Stereo to Mono. Selects first language (Dual I) or second language (Dual II) in bilingual programmes

SLEEP Sets a delay after which the TV switches off

 **MENU** Brings up the menu system.

FREEZE Freezes the picture

EXIT Exits the menu system.

 (up, down, left and right direction buttons) Highlights different items in the menu system and adjusts the menu controls.

OK Confirms your selection.

 **BACK A/CH** Returns to a previous screen.

Toggles between the current channel and the last viewed channel.

INFO Displays the status information.

 Fast reverse button.

 Play/Pause button.

 Fast forward button.

 Stop button.

USB Access the USB mode.

 Increases or decreases volume.

 **(MUTE)** Turns OFF the sound. Press again to restore the volume.

 **FORMAT** Selects a picture format.

CH +/- Scans up or down through the current channel list.

0-9 (numeric buttons) Enters channel numbers.

 **SOUND** Toggles through the sound modes: **Standard, Music, Movie** and **Personal**.

 **PICTURE** Toggles through the picture preset settings: **Vivid, Bright, Cinema,** and **Personal**.

Note: - INCR. SURR, TELETEXT, DEMO, SCENEA, DUAL I/II keys depending on model.

5 Use your TV

Switching on

Follow the instructions on this page on how to switch on your TV set and the remote control before going on to following pages describing how to use the channel set-up procedure.

1. Insert two AAA batteries in the remote control.

Precautions on using batteries:

- Only use the battery types specified.
- Make sure you use the correct polarity.
- Do not mix new and used batteries.
- Do not use rechargeable batteries.
- Do not expose batteries to excessive heat such as sunshine, fire or the like, throw them in a fire, recharge them or try to open them, as this could cause them to leak or explode.
- Remove the batteries from the remote control if you are not using it for a long period of time.

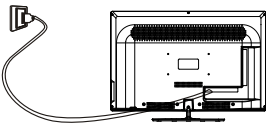

2. Connect the power cable to a mains socket. (If the power cable is not connected to the television, please first connect the power cable to the television.)

Your TV set should only be connected to an AC supply. It must not be connected to a DC supply. If the plug is detached from the cable, do not, under any circumstances, connect it to a mains socket, as there is a risk of electric shock.

Note: The figures are for representation only. The location of the power socket at the back of the television might differ depending on the model.

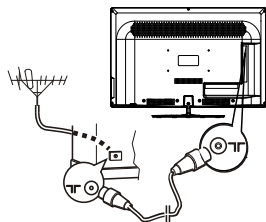

3. Connect the outside aerial or cable network to the ANTENNA IN socket at the back of the TV set.

The aerial socket (75 OHM - VHF / UHF / cable) can be used for connecting an external aerial or other equipment fitted with a modulator (video recorder, satellite receiver, etc.). We recommend that you do not connect other equipment (video recorder, satellite receiver, etc.) to your TV set to begin with, so as not to complicate the set-up procedure with the additional steps involved. Connect them when you have finished setting up the channels.

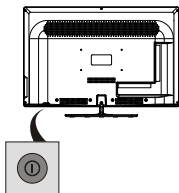

4. Switch the TV on by pressing the power button.

Note: The location and name of the power button on the TV may vary according to TV model, at back side or bottom side of the back cabinets.

If the TV set is in standby mode, press the  button on the remote control or the CH+/- buttons on the TV set to turn on the TV.

Switching off

- To put the TV set into standby mode, press the  button on the remote control. The TV set remains powered up, but with low energy consumption.
- To switch off the TV set, press the power button

1. MAIN GUIDE MENU

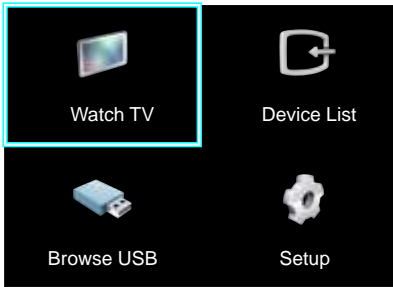

Watch TV: Change source to TV direct.
Browse USB: Change source to USB directly.
Device List: Go into the source list menu.
Setup: Go into the setup menu.

2. PICTURE MENU

You can adjust picture effect here, such as contrast, brightness, etc.
Digital Crystal Clear: To enhance the picture quality, You can Switch this feature ON or OFF.

Press ▲▼ to move, and press ◀▶ to adjust.

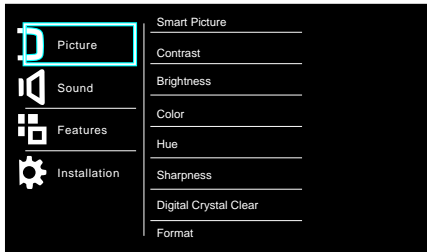

NOTE:

- 1) Hue is available in NTSC system only.
- 2) There are four smart picture modes can be selected, as Vivid, Cinema, Personal, and Bright.
- 3) When Digital Crystal Clear is on, the contrast and brightness is disabled.

3. SOUND MENU

You can adjust the sound effect here such as Treble, Bass, Balance etc.
Press ▲▼ to move, and press ◀▶ to adjust.

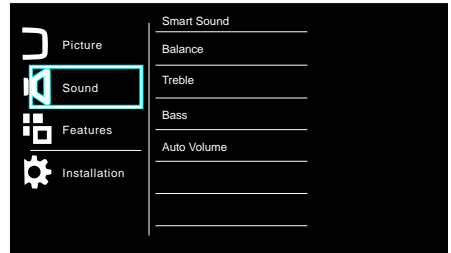

NOTE:

AVL: Auto Volume leveller: When this parameters is on, then volume level gets automatically adjusted, this feature acts as automatic volume leveler which lower the sound output when the sound modulation is high or by rising the sound when the sound modulation is low.
2). There are four Smart Sound modes can be selected, such as standard, music, movie, and personal.

4. FEATURES MENU

You can adjust the Blue Screen on/off, OSD Duration, sleep time etc.
Press ▲▼ to move, and press ◀▶ to adjust.

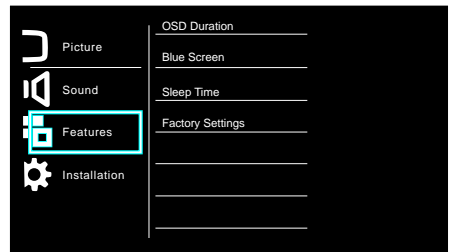

When the source is PC, you can adjust H/V-Position, Clock, and so on.

4. FEATURES MENU IN PC SOURCE

You can adjust the Blue Screen on/off, OSD Duration, sleep time, H/V-Position, Clock and Phase etc.

Press ▲▼ to move, and press ◀▶ to adjust.

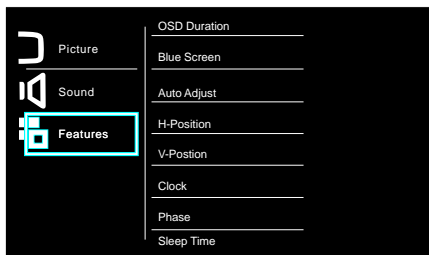

NOTE:

Within 15 minutes there is no signal, the TV will auto sleep.

5. INSTALLATION MENU(for TV source only)

You can search channels and edit programs here. ▲▼ ◀▶

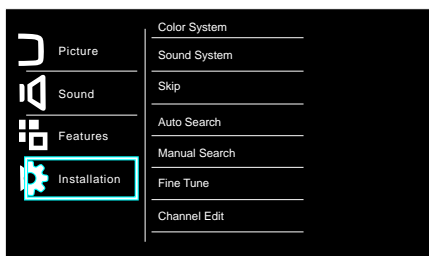

1) Auto Search:

Search all the TV channels automatically.

2) Manual Search:

You can search the TV channels by manual search.

3) Fine Tune:

If the picture is not clear you can fine tune the channel.

4) Channel Edit:

You can Delete, Rename, Move, or Skip any programs.

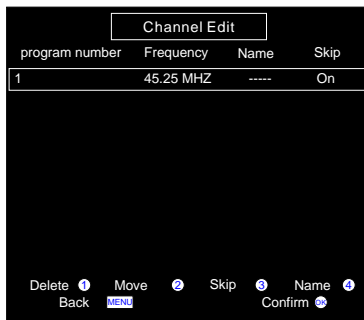

Delete

Press 1 button, the program will be deleted.

Move

Move the cursor to the program, press 2 button, and press ▲▼ to move the program.

Skip

Press 3 button to skip this program.

Name

Move the cursor to the program, press 4 button to rename the program.

Press ▲▼ to choose the character. Press ◀▶ to move the cursor.

Press MENU/OK button to exit edit, Press EXIT to exit the menu.

Note: The TV programs name only can be 5 characters.

6. USB MENU

Change source to USB

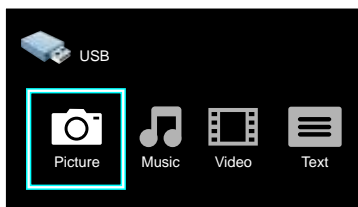

Please make sure that the USB device have plugged in the slot. There are four type media item can be selected, such as Picture, music, Video and text. Select the type media item by pressing, press OK button to enter the disk selection menu.

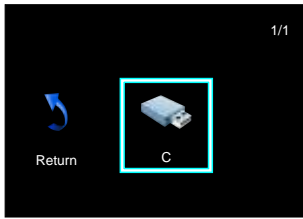

Press the ◀▶ to select the right disk and press OK to display media files and folder list or choose Return to go back to the media type selection menu.

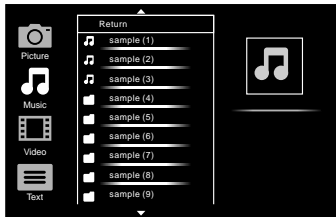

Select the media file by pressing ▲▼, then the preview frame will pop up. Press OK to select or unselect the media file. Press the play key to play the media file in full screen. When the media file (Picture, Music, Video, Text) is playing, press the OK or Info button to display the control bar.

NOTE:

To Exit from Sub menu to Main USB Menu press ↶ **BACK** on Remote Control.

To Exit from USB Source and switch to another source:

1) Press Menu key, Select Device list and Select the Source where you want to switch and press OK key on Remote control.

2) Press Source key on remote and Select the Source where you want switch and press OK key on Remote control.

Music, picture, video, text mode control menu bars

you can select the multimedia functions like Play, Pause, FF, FR, Next, Previous, Stop etc.

Picture mode menu bar:

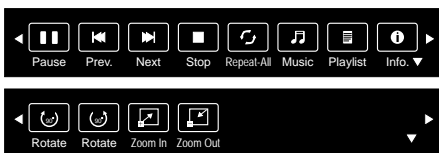

Music mode menu bar:

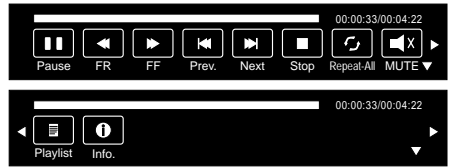

Video mode menu bar:

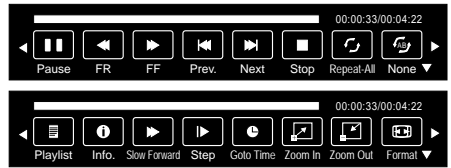

Text mode menu bar:



Press ◀▶ to select the function icon, press OK button to confirm the function.

Press ▼ or EXIT button to exit the control bar.

NOTE:

You can adjust the audio track, subtitle, or program in the Info menu while Playing the video file.

Choose the Info icon and press OK to display the Info MENU.

In the movie mode, when you use FR, FF function, The audio may be pause in several seconds to synchronize the audio signal and video signal.

In text mode, press "<<,>>" to make page up and page down.

: Music function

In text mode and in picture mode, music function will play the music files ,which you selected in the music mode.

When the USB device isn't supported, it may be that the power of the USB device isn't enough.

7. SOURCE LIST MENU

Display the menu by pressing the source key and Select the source by pressing OK key.

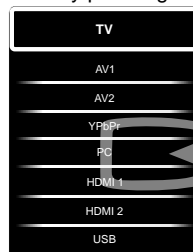

6 FAQ

Attention and Frequently Asked Questions:

Attention:

1. Some non-standard mobile storage device may/may not be recognized. Please change to use the standard device. The USB should be cleaned from virus before using this function.
2. All file in the storage device cannot be edited

Note: For coding files, there are many kinds Non- standard coding method, so this system can not be guaranteed to support the file formats using any coding method.

Frequently Asked Questions:

1. Under the following conditions, this system cannot decode the file and the file can not play normally:
 - The parameters of file, such as the pixel of picture, code rate of audio and video file, sampling rate of audio file, exceed the limit of the system;
 - The format of file is not matched or the file is harmed.
2. Hot plug: Do not disconnect when the system is reading or transmitting data, avoid damaging the system or the device.
3. Pay attention to the power supply of the device when you are using a mobile hard disk or a digital camera. If the power supply is not sufficient or not stable, you may encounter problems during operating or can not operate at all. In this case, please restart the device, or unplug the device and plug it again, and ensure that its power supply is normal.
4. The system supports standard USB 1.1 and USB 2.0 devices, such as standard U-disks, Mp3 players, mobile hard disks, etc..
5. For obtaining better audio and video quality, suggests to use the external device which accords with USB 2.0 standard.
6. For some USB device with power supply, such as large size hard disk, Mp4, etc., Suggests using it with power to avoid electric power shortage.

7 Other Information

Troubleshooting

Most problems you encounter with your TV can be corrected by consulting the following troubleshooting list.

No picture, no sound

1. Check if the fuse or circuit breaker is working.
2. Plug another electrical device into the outlet to make sure it is working or turned on.
3. Power plug is in a bad contact with the outlet.
4. Check the signal source.

No color

1. Change the color system.
2. Adjust the saturation.
3. Try another channel. Black-white program may be received.

Remote control does not work

1. Change the batteries.
2. Batteries are not installed correctly.
3. Main power is not connected.

No picture, normal sound

1. Adjust the brightness and contrast.
2. Broadcasting failure may happen.

Normal picture, no sound

1. Press the **Vol+** button to increase volume.
2. Volume is set to mute, press the mute button to restore sound.
3. Change the sound system.
4. Broadcasting failure may happen.

Unorderly ripples on the picture

It is usually caused by local interference, such as cars, daylight lamps and hair driers. Adjust the antenna to minimize the interference.

Blank screen in VGA mode

Perhaps the TV can not recognize the resolution set by the PC. Suggest to change to the best resolution or other standard resolutions of the Windows system.

Snowy dots and interference

If the antenna is located in the fringe area of a television signal where the signal is weak, the picture may be marred by dots. When the signal is extremely weak, it may be necessary to install a special antenna to improve the reception.

1. Adjust the position and orientation of the indoor/outdoor antenna.
2. Check the connection of antenna.
3. Fine tune the channel.
4. Try another channel. Broadcasting failure may happen.

Ignition

Black spots or horizontal streaks appear, or the picture flutters or drifts. This is usually caused by interference from car ignition system, neon lamps, electric drills, or other electrical appliance.

Ghost

Ghosts are caused by the television signal following two paths. One is the direct path, the other is reflected from tall buildings, hills, or other objects. Changing the direction or position of the antenna may improve the reception.

Radio frequency interference

This interference produces moving ripples or diagonal streaks, and in some case, loss of contrast in the picture. Find out and remove the radio interference source.

8 Product information

Product information is subject to change without notice. For detailed product information, go to www.philips.com/support.

Supported display resolutions

Computer formats (HDMI)

- Resolution - refresh rate:
 - 640 x 480 - 60Hz, 72Hz, 75Hz
 - 720 x 400 - 70Hz
 - 800 x 600 - 56Hz, 60Hz, 72Hz
 - 1024 x 768 - 60Hz, 70Hz, 75Hz
 - 1280 x 960 - 60Hz
 - 1280 x 1024 - 60Hz, 70Hz, 75Hz

Computer formats (VGA)

- Resolution - refresh rate:
 - 640 x 480 - 60Hz, 72Hz, 75Hz
 - 720 x 400 - 70Hz
 - 800 x 600 - 56Hz, 60Hz, 72Hz
 - 1024 x 768 - 60Hz, 70Hz, 75Hz
 - 1280 x 960 - 60Hz
 - 1280 x 1024 - 60Hz, 70Hz, 75Hz

Video formats

- Resolution - refresh rate:
 - 480i - 60Hz
 - 480p - 60Hz
 - 576i - 50Hz
 - 576p - 50Hz
 - 720p - 50Hz, 60Hz
 - 1080i - 50Hz, 60Hz
 - 1080p - 50Hz, 60Hz
(For FHD model only)

Multimedia

- Supported USB storage device:
(Only FAT 16 or FAT 32 USB storage devices are supported)
- Supported storage file formats:
 - Images: JPEG, BMP, JPE, PNG.
 - Audio: Mp3
 - Video:

File Extension	Container	Video Decoder
*.avi	AVI	MPEG 1/2/4, H.264
.mp4/.mov	MP4	MPEG 4, H.264
*.mkv	MKV	MPEG 4, H.264
.mpg/.mpeg	PS	MPEG 1/2
*.wmv	ASF	VC-1

- TEXT: TXT



Note

Multimedia file names must not exceed 128 characters.

Tuner/ Reception/ Transmission

- Antenna input: 75ohm coaxial (IEC75)
- TV system: PAL
- Video playback: PAL, NTSC

Remote control

- Batteries: 2 x AAA

Power

- Mains power: AC 110-240V, 50-60Hz
- Standby power: <1W
- Ambient temperature: 5 to 40 degrees Celsius

Supported TV mounts

To mount the TV, purchase a Philips TV mount or a VESA-compatible TV mount. To prevent damage to cables and connectors, be sure to leave a clearance of at least 2.2 inches or 5.5cm from the back of the TV.

TV screen size (inches)	Required pitch (mm)	Required mounting bolts
22PFL4556/V7	100 X 100	4 x M4
32PFL4356/V7	100 X 200	4 x M4
32PFL4556/V7	100 X 200	4 x M4

Product specification

Design and specifications are subject to change without notice.

22PFL4556/V7

- Without TV stand
 - Dimension (WxDxH): 528 x 38 x 345 (mm)
 - Weight: 3.5kg

32PFL4356/V7

32PFL4556/V7

- Without TV stand
 - Dimension (WxDxH): 768 x 43 x 492 (mm)
 - Weight: 7.2kg

Consumer Guidelines

1. Kindly ensure that the dealer fills out the Warranty card correctly.
2. To avail the Warranty please register your product with the Philips -
 - Log on to www.Philips.com
 - OR
 - Contact Philips Consumer Care Centre
3. In the unlikely event of a defect developing in the TV set contact the Philips Customer Care Centre for obtaining warranty service and inform of the defect observed in the set, the type no. and serial no. of the set.
4. On your lodging a complaint, a trained technician will call on you promptly. In the event of the technician deciding that set requires attention at the service station; the technician would arrange to get the set picked up to be delivered to the service station for further attention. "Home calls" by the technician would however be restricted within the municipal limits of the city / town in which the set has been registered.

Type no. _____ Serial No. _____ Date of Purchase _____

Purchased By: Name _____

Address: _____

_____ Tel. No. _____

Sold by: Name _____

Address: _____

_____ Tel. No. _____

PHILIPS

Model no.: 22PFL4556/V7
32PFL4356/V7
32PFL4556/V7

Serial no.:



MADE IN PRC

Sold by (User rubber stamp)

Contact Customer Service Executive at:

1860 180 1111 (Standard Call Rate Apply)
1800 102 2929 (Toll free No.)

Regd Office: PE Electronics Ltd, Auto Cars Compound, Adalat Road, Aurangabad, 431005.

WARRANTY

This TV receiver is covered under warranty against any defect arising out of faulty or defective material or workmanship for a period of 12 months from the date of purchase.

Should a defect develop in this set during the period of warranty, PE Electronics Limited undertakes to get the set repaired free of charge either.

From whom the set has been purchased or through an Authorised Service Center for warranty service. However, if the Purchaser has to shift his residence to another town on account of transfer or other reasons, the warranty benefit will be available at the Authorised Service Center of that town.

The warranty is not valid in case of any of the following events:

- The TV set is not used according to instructions given in the 'Direction for use' / 'User Manual'.
- Defects are caused by improper or reckless use.
- Any repair work carried out by persons other than a Philips dealer or Authorised Service Center.
- Any modification or alteration of any nature made in the electrical circuitry of the set.
- This Warranty Card is not completed and signed immediately on delivery of the set by the Philips Dealer.
- Fading effects and/or Ghosts (Multiple Image) in picture, if any, arising due to location / signal reception.
- Defects due to causes beyond control like lightning, abnormal voltage, Acts of God or while in transit to purchaser's residence.

(Refer Consumer Guidelines for further details)

PHILIPS



Specifications are subject to change without notice.

* PHILIPS and the PHILIPS Shield Emblem are registered trademarks of Koninklijke Philips Electronics N.V. and are used under license from Koninklijke Philips Electronics N.V.*

www.philips.com