

Register your products and get support at
www.philips.com/welcome

4000 Series

Quick start guide

PHILIPS



English

Before using your product, read all accompanying safety information.
(The relevant parameters of instructions are variable, without prior notice, if there is any discrepancy, please in accordance with actual object.)

ภาษาไทย

ก่อนการใช้ผลิตภัณฑ์ของคุณกรุณาอ่านให้เข้าใจในข้อมูลทั้งที่เกี่ยวกับด้านความปลอดภัยที่มาพร้อมคู่มือนี้
(ค่าต่างๆ ที่ใช้ในคู่มือเป็นค่าตัวแปรเท่านั้นและอาจเปลี่ยนแปลงได้โดยไม่ต้องแจ้งให้ทราบล่วงหน้า หากมีความแตกต่าง ให้ยึดค่าที่อุปกรณ์จริง)

Tiếng Việt

Trước khi sử dụng sản phẩm quý vị hãy đọc tất cả các thông tin về an toàn đính kèm.
(Các thông số liên quan trong các hướng dẫn có thể thay đổi mà không cần báo trước, nếu có bất kỳ sự khác biệt nào, hãy tuân theo sản phẩm thực tế.)



English What's in the box
ภาษาไทย สิ่งที่มีอยู่ในกล่อง
Tiếng Việt Phụ kiện và tài liệu kèm theo trong hộp

(24")

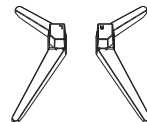
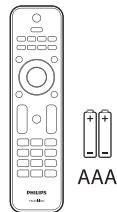
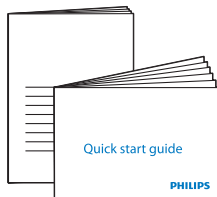
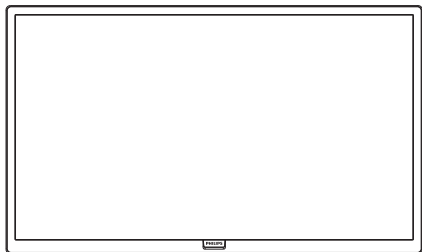

1

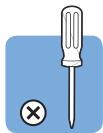

English
ภาษาไทย
Tiếng Việt

Mount the stand
ตั้งขาตั้งจอทีวี
Gắn giá đỡ

(24")

1

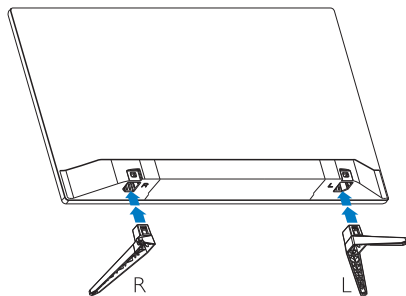
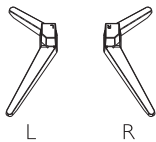

2

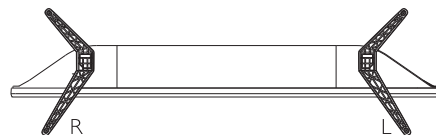

3

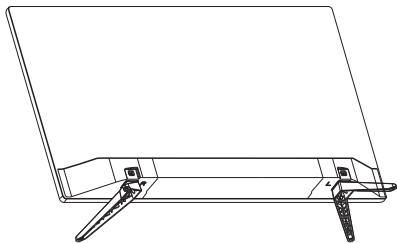

2

English Connect
ภาษาไทย ต่อพวงสาย
Tiếng Việt Kết nối

(24")

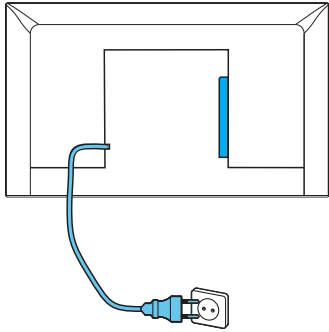

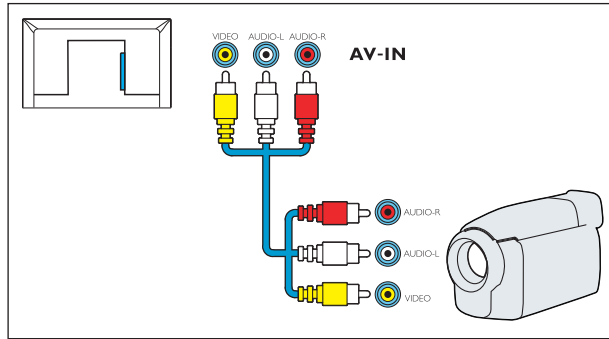
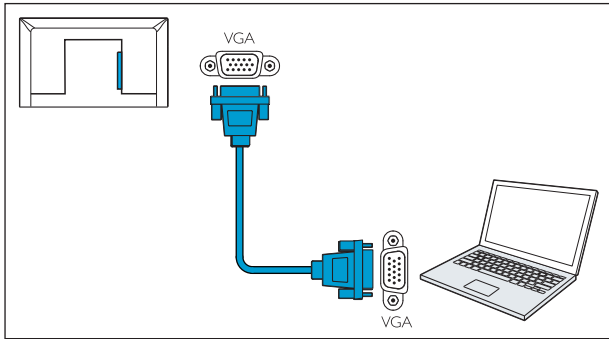
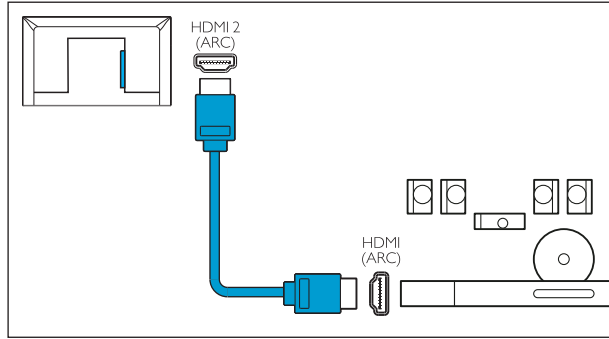
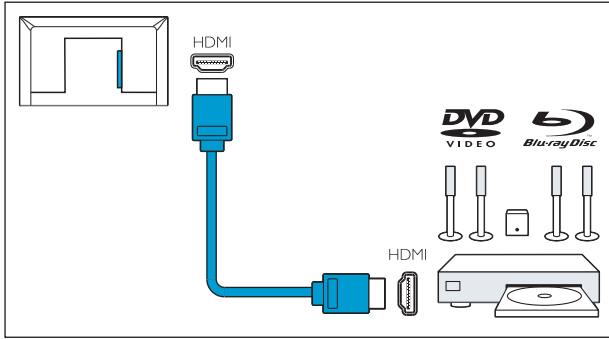

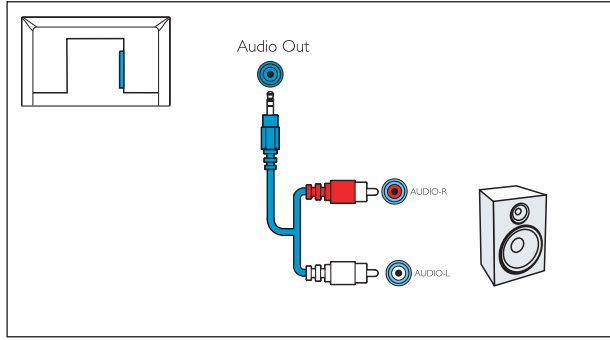
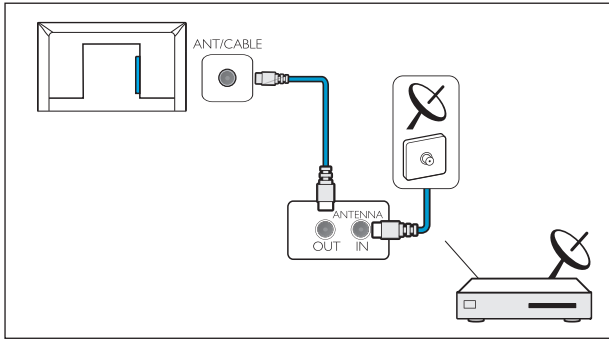

3

English Insert batteries
ภาษาไทย การใส่แบตเตอรี่
Tiếng Việt Lắp pin

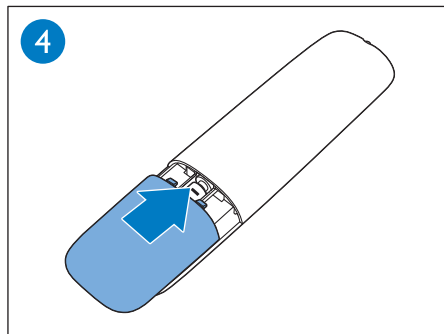
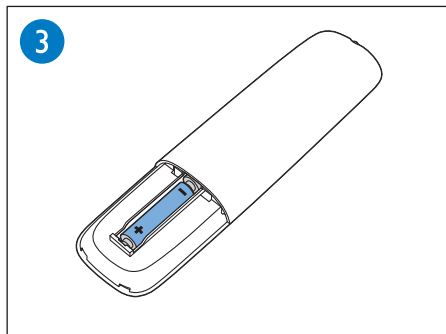
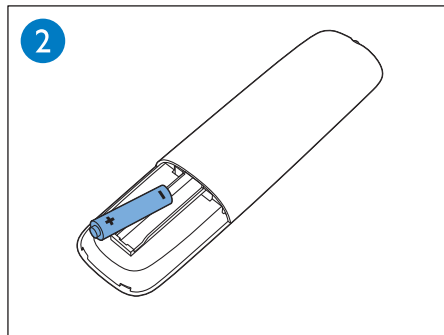
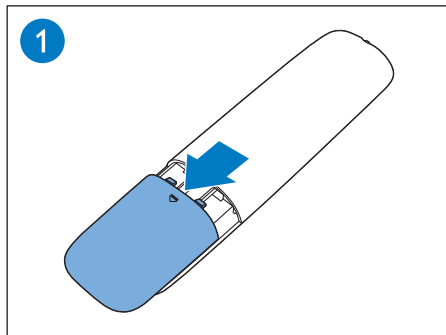



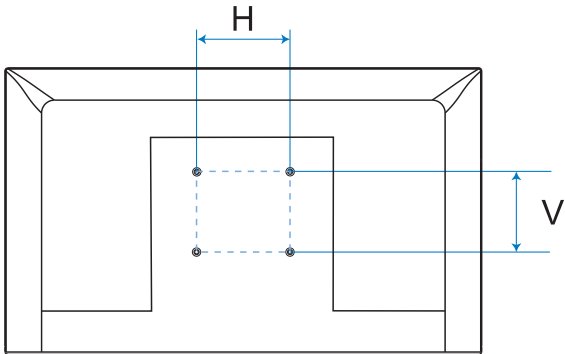

English To wall mount, purchase a suitable bracket.
ภาษาไทย การติดตั้งบนผนัง กรุณาซื้อขาแขวนทีวีที่เหมาะสม
Tiếng Việt Để gắn lên tường, hãy mua một giá đỡ phù hợp.



TV	H	V
60 cm / 24"	100 mm	100 mm

4

- English Press the  key on the side panel of the TV or on the remote control to turn on the TV.
- ภาษาไทย กดปุ่ม  บนแผงควบคุมด้านข้างของทีวีหรือบนรีโมทคอนโทรลเพื่อเปิดทีวี
- Tiếng Việt Nhấn nút  trên bảng điều khiển bên hông của tivi hoặc trên điều khiển từ xa để bật tivi.

(24")

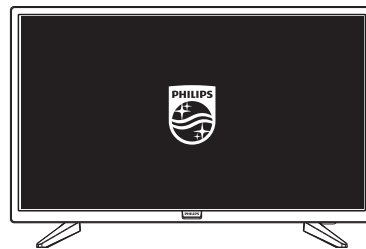
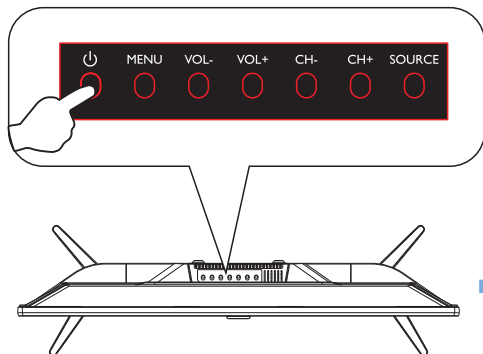
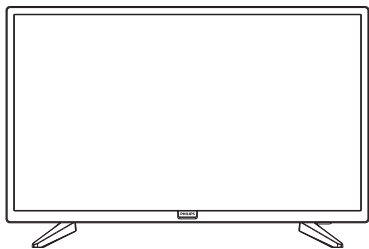



English Please refer to the User's Manual and the Philips support website for more operating instructions.

ภาษาไทย กรุณาอ่านคู่มือผู้ใช้ให้เข้าใจและศึกษาข้อมูลเพิ่มเติมสำหรับการปฏิบัติการเพิ่มเติมอื่นๆ ได้ที่เว็บไซต์ของบริษัทฟิลิปส์

Tiếng Việt Vui lòng xem Tài Liệu Hướng Dẫn Sử Dụng và trang web hỗ trợ của Philips để tìm hiểu thêm về các hướng dẫn vận hành





All registered and unregistered trademarks are property of their respective owners. Specifications are subject to change without notice. Philips and the Philips' shield emblem are trademarks of Koninklijke Philips N.V. and are used under license from Koninklijke Philips N.V.

2018 © TPVision Europe B.V. All rights reserved.
philips.com

