

Register your product and get support at

www.philips.com/welcome

PFL3008

PFL4008

PFL4308

EN User Manual

PHILIPS

Contents

2 Important 4

Safety 4

3 Your TV 7

Rear controls 7

Remote control 7

Remote control usage 8

4 Use your TV 9

Switch TV on or off 9

Switch channels 9

Watch connected devices 10

Adjust TV volume 10

5 Use more of your TV 11

Access TV Menus 11

Change picture and sound settings 11

Adjust settings 12

Use timers 14

Adjust VGA settings 14

Play multimedia files from USB device 15

Update TV software 17

Reset factory settings 17

6 Install channels 18

Automatically install channels 18

Update channels 18

Manually install channels 18

Rename channels 19

7 3D settings 20

Convert 2D to 3D 20

Adjust 3D settings 20

8 Connect your TV 22

Back connectors 22

Side connectors 23

Connect a computer 24

Use Philips EasyLink 25

9 Product Information 26

Display resolutions 26

Multimedia 26

Sound Power 26

Inherent Resolution 26

Tuner/ Reception/ Transmission 26

Remote Control 26

Power 27

Supported TV Mounts 27

10 Troubleshooting 28

General issues 28

Channel issues 28

Picture issues 28

HDMI connection issues 29

Computer connection issues 29

Contact us 29

1 Notice

2013© TP Vision Netherlands B.V. All rights reserved. Specifications are subject to change without notice. Trademarks are the property of Koninklijke Philips Electronics N.V or their respective owners. TP Vision Netherlands B.V. reserves the right to change products at any time without being obliged to adjust earlier supplies accordingly.

The material in this manual is believed adequate for the intended use of the system. If the product, or its individual modules or procedures, are used for purposes other than those specified herein, confirmation of their validity and suitability must be obtained. TP Vision Netherlands B.V. warrants that the material itself does not infringe any United States patents. No further warranty is expressed or implied.

TP Vision Netherlands B.V. cannot be held responsible neither for any errors in the content of this document nor for any problems as a result of the content in this document. Errors reported to Philips will be adapted and published on the Philips support website as soon as possible.

Terms of warranty

- Risk of injury, damage to TV or void of warranty! Never attempt to repair the TV yourself.
- Use the TV and accessories only as intended by the manufacturer.
- The caution sign printed on the back of the TV indicates risk of electric shock. Never remove the TV cover. Always contact Philips Customer Support for service or repairs.



- Any operation expressly prohibited in this manual, or any adjustments and assembly procedures not recommended or authorised in this manual shall void the warranty.

Pixel characteristics

This LCD/LED product has a high number of color pixels. Although it has effective pixels of 99.999% or more, black dots or bright points of light (red, green or blue) may appear constantly on the screen. This is a structural property of the display (within common industry standards) and is not a malfunction.

Mains fuse (/56 sets only)

This TV is fitted with an approved moulded plug. Should it become necessary to replace the mains fuse, this must be replaced with a fuse of the same value as indicated on the plug (example 10A).

- 1 Remove fuse cover and fuse.
- 2 The replacement fuse must comply with BS 1362 and have the ASTA approval mark. If the fuse is lost, contact your dealer in order to verify the correct type.
- 3 Refit the fuse cover.

Copyright



®Kensington and Micro Saver are registered US trademarks of ACCO World corporation with issued registrations and pending applications in other countries throughout the world.



HDMI, the HDMI logo and High-Definition Multimedia Interface are trademarks or registered trademarks of HDMI licensing LLC in the United States and other countries. All other registered and unregistered trademarks are the property of their respective owners.

2 Important

Read and understand all instructions before you use your TV. If damage is caused by failure to follow instructions, the warranty does not apply.

Safety

Risk of electric shock or fire!

- Never expose the TV to rain or water. Never place liquid containers, such as vases, near the TV. If liquids are spilt on or into the TV, disconnect the TV from the power outlet immediately. Contact Philips Consumer Care to have the TV checked before use.
- Never place the TV, remote control or batteries near naked flames or other heat sources, including direct sunlight. To prevent the spread of fire, keep candles or other flames away from the TV, remote control and batteries at all times.



- Never insert objects into the ventilation slots or other openings on the TV.
- When the TV is swivelled ensure that no strain is exerted on the power cord. Strain on the power cord can loosen connections and cause arcing.
- To disconnect the TV from the mains power, the power plug of the TV must be disconnected. When disconnecting the power, always pull the power plug, never the cord. Ensure that you have full access to the power plug, power cord and outlet socket at all times.

Risk of short circuit or fire!

- Never expose the remote control or batteries to rain, water or excessive heat.

- Avoid force coming onto power plugs. Loose power plugs can cause arcing or fire.

Risk of injury or damage to the TV!

- Two people are required to lift and carry a TV that weighs more than 25 kg or 55 lbs.
- When stand mounting the TV, use only the supplied stand. Secure the stand to the TV tightly. Place the TV on a flat, level surface that can support the combined weight of the TV and the stand.
- When wall mounting the TV, use only a wall mount that can support the weight of the TV. Secure the wall mount to a wall that can support the combined weight of the TV and wall mount. TP Vision Netherlands B.V. bears no responsibility for improper wall mounting that results in accident, injury or damage.
- If you need to store the TV, disassemble the stand from the TV. Never lay the TV on its back with the stand installed.
- Before you connect the TV to the power outlet, ensure that the power voltage matches the value printed on the back of the TV. Never connect the TV to the power outlet if the voltage is different.
- Parts of this product may be made of glass. Handle with care to avoid injury and damage.

Risk of injury to children!

Follow these precautions to prevent the TV from toppling over and causing injury to children:

- Never place the TV on a surface covered by a cloth or other material that can be pulled away.
- Ensure that no part of the TV hangs over the edge of the surface.
- Never place the TV on tall furniture (such as a bookcase) without anchoring both the furniture and TV to the wall or a suitable support.
- Educate children about the dangers of climbing on furniture to reach the TV.

Risk of swallowing batteries!

- The product/remote control may contain a coin-type battery, which can be swallowed.

Keep the battery out of reach of children at all times!

Risk of overheating!

- Never install the TV in a confined space. Always leave a space of at least 4 inches or 10 cm around the TV for ventilation. Ensure curtains or other objects never cover the ventilation slots on the TV.

Risk of injury, fire or power cord damage!

- Never place the TV or any objects on the power cord.
- Disconnect the TV from the power outlet and antenna before lightning storms. During lightning storms, never touch any part of the TV, power cord or antenna cable.

Risk of hearing damage!

- Avoid using earphones or headphones at high volumes or for prolonged periods of time.

Low temperatures

- If the TV is transported in temperatures below 5°C or 41°F, unpack the TV and wait until the TV temperature matches room temperature before connecting the TV to the power outlet.

3D health warning

Applicable for PFL4308 series

- If you or your family has a history of epilepsy or photosensitive seizures, consult a medical professional before exposing yourself to flashing light sources, rapid image sequences or 3D viewing.
- To avoid discomfort such as dizziness, headache or disorientation, we recommend not watching 3D for extended periods of time. If you experience any discomfort, stop watching 3D and do not immediately engage in any potentially hazardous activity (for example driving a car) until your symptoms have disappeared. If symptoms persist, do not resume watching 3D without consulting a medical professional first.

- Parents should monitor their children during 3D viewing and ensure they do not experience any discomfort as mentioned above. Watching 3D is not recommended for children under six years of age as their visual system is not fully developed yet.
- Do not use the 3D glasses for any purpose

Screen care

- Avoid stationary images as much as possible. Stationary images are images that remain on-screen for extended periods of time. Examples include: on-screen menus, black bars and time displays. If you must use stationary images, reduce screen contrast and brightness to avoid screen damage.
- Unplug the TV before cleaning.
- Clean the TV and frame with a soft, damp cloth. Never use substances such as alcohol, chemicals or household cleaners on the TV.
- Risk of damage to the TV screen! Never touch, push, rub or strike the screen with any object.
- To avoid deformations and color fading, wipe off water drops as soon as possible.

Recycling



Your product is designed and manufactured with high quality materials and components, which can be recycled and reused.



When this crossed-out wheeled bin symbol is attached to a product it means that the product is covered by the European Directive 2002/96/EC. Please inform yourself about the local separate collection system for electrical and electronic products.

Please act according to your local rules and do not dispose of your old products with your normal household waste.

Correct disposal of your old product helps to prevent potential negative consequences for the environment and human health.



Your product contains batteries covered by the European Directive 2006/66/EC, which cannot be disposed of with normal household waste.

Please inform yourself about the local rules on separate collection of batteries because correct disposal helps to prevent negative consequences for the environment and human health.

3 Your TV

Congratulations on your purchase, and welcome to Philips! To fully benefit from the support that Philips offers, register your TV at www.philips.com/welcome.

Rear controls

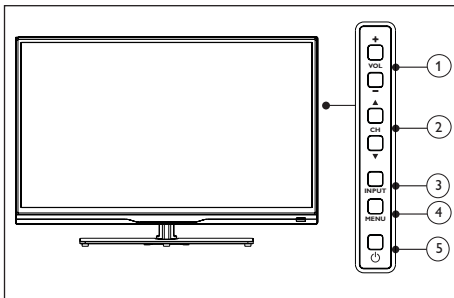

- ① **VOL+/-**: Increases or decreases volume.
- ② **CH▲/▼**: Switches to the next or previous channel.
- ③ **INPUT**: Press this button to display the list of available signal sources.
- ④ **MENU**: Toggles the home menu on or off.
- ⑤ **⏻ (Standby)**: Switches between the On and Standby modes. To completely cut off power supply, the power plug must be pulled out.

Remote control

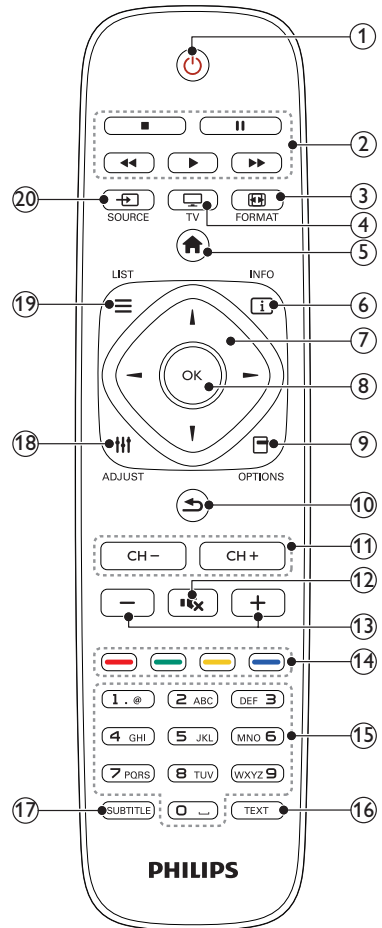

- ① **⏻ (Standby)**
Switch the TV on or to standby.
- ② **Play buttons**
Control video or music.
- ③ **FORMAT**
Change picture format.
- ④ **TV**
Switch source to watch TV.

- 5 **🏠 (Home)**
Access the home menu.
- 6 **ℹ️ INFO**
Display information about current activity.
- 7 **▲▼◀▶ (Navigation buttons)**
Navigate through menus and select items.
- 8 **OK**
Confirm an entry or selection.
- 9 **⊞ OPTIONS**
Access options for the current activity or selection.
- 10 **↶ (Back)**
Return to the previous menu or exit a function.
- 11 **CH +/- (Channel +/-)**
Switch channels.
- 12 **🔇 (Mute)**
Mute or restore audio.
- 13 **+/- (Volume)**
Adjust volume.
- 14 **Color buttons**
Select tasks or options.
- 15 **0-9 (Numeric buttons)**
Select channels.
- 16 **TEXT**
Enable or disable teletext.
- 17 **SUBTITLE**
Enable or disable subtitles.
- 18 **⚙️ ADJUST**
Access the setup menu.
- 19 **☰ LIST**
Access the TV channel list.
- 20 **📺 SOURCE**
Select connected devices.

Remote control usage

When you use the remote control, hold it close to the TV and point it at the remote control sensor. Make sure that the line-of-sight between the remote control and TV is not blocked by furniture, walls or other objects.

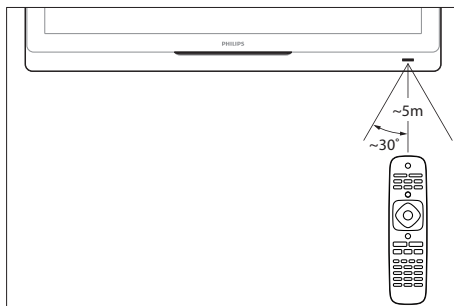

4 Use your TV

This section helps you perform basic TV operations.

Switch TV on or off

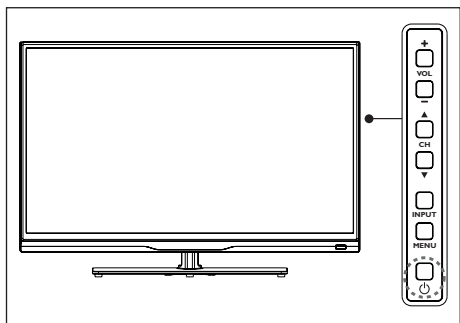

To switch on

- Plug in the power plug.
- If the standby indicator is red, press **⏻ (Standby-On)** on the remote control or on the side of the TV.
 - ↳ The standby indicator will switch to blue and the TV screen will light up.

To switch to standby

- Press **⏻ (Standby-On)** on the remote control or on the side of the TV.
 - ↳ The standby indicator switches to red.



Tip

- Though your TV consumes very little power when in standby mode, energy continues to be consumed. When not in use for an extended period of time, disconnect the TV power cable from the power outlet.

Switch channels

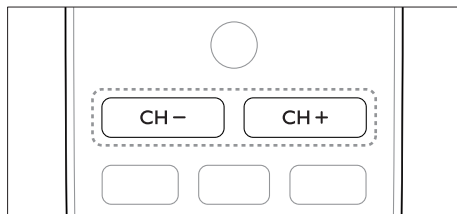
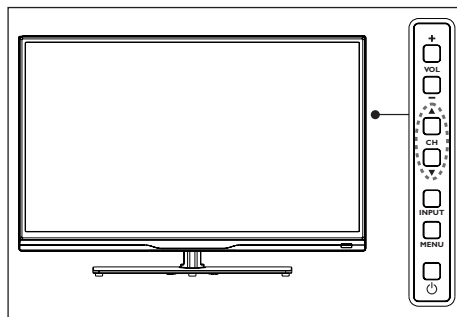

- Press **CH +/-** on the remote control or **CH ▲▼** on the right rear of the TV.
- Enter a channel number using the numeric buttons on the remote control.
- Press **↩** on the remote control to switch and return to the previous channel.

View installed channel

You can view all available channels on the channel list.

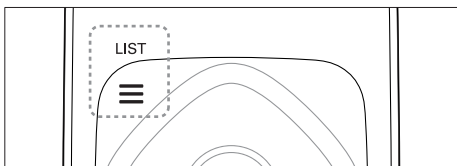

- 1 Press **OK** or **≡ LIST**.
↳ The channel list appears.
- 2 Press **▲▼** to select a channel and browse the channel list.
- 3 Press **OK** to watch the selected channel.
- 4 Press **↶** to switch to and resume the last watched channel.

Watch connected devices

Note

- Switch on the device before selecting it as an external signal source.

Use the Source button

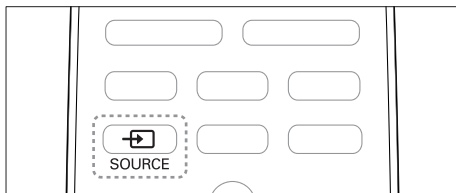

- 1 Press **⏏ SOURCE**.
↳ The source list appears.
- 2 Press **▲▼** to select a device.
- 3 Press **OK** to select.
↳ The TV switches to the selected device.

Adjust TV volume

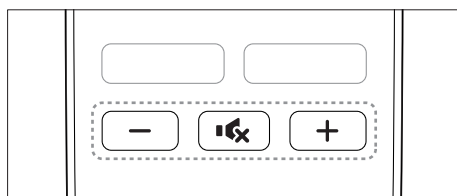
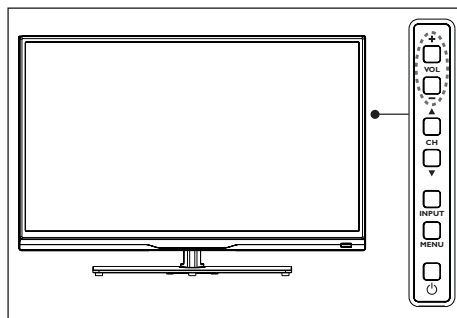

To increase or decrease volume

- Press **VOL +/-** on the TV or **the volume controls +/-** on the remote control.

To mute or unmute sound

- Press **🔇 (Mute)**.
- Press **🔊** again to restore the sound.

5 Use more of your TV

Access TV Menus

Menus help you to set channels, change picture and sound settings and access other features.

- 1 Press **Home** .
↳ The menu screen appears.

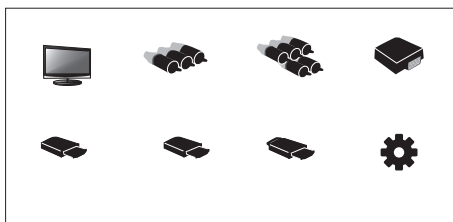

- 2 Select **[Setup]**.
- 3 Press **▲▼◀▶** to choose from the following options:
 - **[Picture]** / **[Sound]** / **[TV]** (available only in TV mode) / **[Settings]** / **[Parental]** / **[VGA setting]** (available only in PC mode) / **[EasyLink]**.
- 4 Press **OK** to select.
- 5 Press **Home** to exit.

Change picture and sound settings

Change picture and sound settings to suit your preferences. You can apply pre-defined settings or change settings manually.

Adjust picture settings

- 1 Press **ADJUST** and select **[Picture]**.
↳ The **[Picture]** menu will appear:

- 2 Press **▲▼◀▶** to select / adjust the settings:
 - **[Smart Picture]:**
 - **[Standard]:** Standard picture settings. Recommended for family entertainment purposes.
 - **[Eco]:** Reduces the intensity of the backlight for lower energy consumption.
 - **[Vivid]:** Enhances picture contrast and sharpness.
 - **[Movie]:** Applies settings for watching movies, best enjoyed in a cinematic environment.
 - **[Personal]:** Users can customise the settings here.
 - **[Brightness]:** Adjusts the intensity and details of darker areas (adjustments can only be stored as personal settings).
 - **[Video contrast]:** Adjusts the intensity in the bright areas; the dark areas remain unchanged (adjustments can only be stored as personal settings).
 - **[Color]:** Adjusts color saturation (adjustments can only be stored as personal settings).
 - **[Tint]:** Adjusts the level of green (only appears for NTSC format content).
 - **[Sharpness]:** Adjusts sharpness in the image (adjustments can only be stored as personal settings).
 - **[Color Temperature]:**
 - **[Cool]:** Bluish-white tint.
 - **[Normal]:** White tone. Users can customise the white tones in PC mode.
 - **[Warm]:** Pinkish-white tint.
 - **[Advanced Control]:**
 - **[Noise Reduction]:** Filters and removes the noise from the image signals.
 - **[Backlight]:** Adjusts the screen brightness (when the control value of the backlight is low, a white flash of light may appear when you switch on the TV. This is a normal response).

When **[Dynamic Backlight]** is enabled, this feature will be hidden).

- **[Dynamic Contrast]:** The maximum level of contrast. (There is no Advanced Contrast feature in PC mode).
- **[Dynamic Backlight]:** The contrast will adjust itself according to the level of image brightness.

Adjust sound settings

1 Press **III** ADJUST and select **[Sound]**.

↳ The **[Sound]** menu will appear.

2 Press **▲▼◀▶** to select and adjust your settings:

- **[Smart Sound]:**
 - **[Standard]:** Outstanding performance that is balanced for all sound frequencies (treble / midrange / bass).
 - **[Music]:** Enhanced treble and bass sounds that produces a clear and pure sound, excellent for listening to piano and orchestra performances.
 - **[Speech]:** Enhances the registration of the human vocal range, excellent for listening to news, cultural and arts programs.
 - **[Personal]:** Provides users with customised features to optimise for all sound parameters for the best experience.
- **[Balance]:** Adjusts the balance of the right and left speakers.
- **[Bass]:** Adjusts the bass level (adjustments can only be stored as personal settings).
- **[Treble]:** Adjusts the treble level (adjustments can only be stored as personal settings).
- **[Virtual Surround]:** Enable Virtual Surround sound: On or Off.
- **[AVL]:** Enables automatic adjustment of volume.

Adjust settings

1 Press **III** ADJUST and select **[Settings]**.

↳ The **[Settings]** menu will appear.

2 Press **▲▼◀▶** to select and adjust your settings:

- **[Menu Language]:** Adjusts the language settings of the TV.
- **[Picture Format]:** Most signals are in 16:9, 4:3, Zoom 1 and Zoom 2 formats; HDMI sources come in 16:9, 4:3, Point To Point, Zoom 1 and Zoom 2 formats; VGA sources from a PC comes in 16:9, 4:3 and Point To Point formats.
- **[Menu Timeout]:** Sets the display period of the menu.
- **[Menu Transparency]:** Sets the level of transparency for the menu display.
- **[Blue Screen]:** Sets the screen color of the TV in the absence of signals (when the TV signals are not working).
- **[Auto Sleep]:** Sets the automatic shutdown time of the TV after a period of non-activity
- **[Sleep Timer]:** Sets the length of time of non-activity before the TV switches automatically into Standby mode. Adjust the time using the Sleep button on the remote control. Choose from: off/10/20/30/60/90/120/180 minutes. (Not applicable when in PC mode).
- **[Power On Status]:** Sets the TV condition upon connecting to an AC power.
- **[Time Setup]:** Sets the system time.
- **[Freeze Switch]:** Sets the mode for changing of channels. (Only appears for the TV mode)

- **[3D Setup]***: Sets 3D features.
 - **[3D Detect]**: Sets 3D Detect mode.
 - **[3D Type]**: Manual setting of 3D Type. **[3D Detect]** must be manually set).
 - **[Left-Right Swap]**: Sets the mode for Left-Right Swap.
 - **[3D Scene]**: Sets the 3D depth of field.
- **[TTX Language]**: Sets the teletext language (Only available in TV mode).
- **[Color System]**: Sets the AV color system. (Only appears for the AV mode).
- **[HDMI]**: Sets the HDMI mode. (Only appears for 480p / 576p / 720p / 1080p HDMI mode).
- **[Reset]**: Reset default settings. (Excludes password settings and channel information).

* Available on PFL4308 series.

Change picture format

- 1 Press **≡** ADJUST and select **[Settings]**.
- 2 Press **▲▼◀▶** to select **[Picture Format]**.
- 3 Select a **picture format**.
- 4 Press **OK** to confirm.

Summary of picture formats

The following picture settings can be configured.

Note

- Depending on the format of the picture source, some picture settings are not available.



[16:9]: Scales the classic standard ratio into a wide screen format.



[4:3]: The classic standard format.

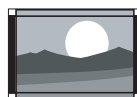

[Zoom 1]: Horizontal extension to a wide screen picture format. When using this format, the left and right sides of the picture frames will be cropped off.



[Zoom 2]: Scales the standard ratio into a wide screen format. (Only Standard, Wide screen and Point To Point options are available when in PC mode).



[Point To Point]: Applicable for HDMI connection to PC. The full screen from the PC will be shown to reap the best effectiveness in display.

Use timers

You can set timers to switch the TV to standby at a specified time.



Tip

- Set the sleep timer before you use timers.

Set sleep timer



Tip

- You can switch off your TV earlier or reset the sleep timer when the time is up.

- 1 Press **III** ADJUST and select **[Settings]**.
- 2 Press **▲▼◀▶** to select **[Sleep Timer]**.
- 3 Press **▲▼** to set your sleep time.
 - ↳ The sleep timer can be set up to 180 minutes.

TV locks

You can prevent your children from watching certain programs or channels by locking the TV controls.

Set or change your password

- 1 Press **III** ADJUST and select **[Parental]**.
- 2 Select **[Enter password]** or select **[Change Password]**.
- 3 Enter your password using the numeric buttons on the remote control.
- 4 Follow the on-screen instructions to create or change your password.

Lock channels

- 1 Press **III** ADJUST and select **[Parental]**.
- 2 Enter password and select **[Channel Lock]**.
- 3 Select channel. Press **OK** to lock or unlock channel.
- 4 Repeat the steps to lock or unlock more channels.
 - **[Channel Lock]**: When a channel is locked:
 - Enter your four-digit password to access the Channel Block menu.
 - Enter your four-digit password to view locked channels.
 - Enter your four-digit password to access the parental controls menu.
 - **[Clear All]**: This function will clear all previously stored locked channels and source settings.
 - The default password is '0000'. The user can change and set your own password.



Note

- You will be prompted to enter your password when attempting to view the locked channel.

Adjust VGA settings

- 1 Press **III** ADJUST and select **[VGA setting]**.
 - ↳ The **[VGA setting]** menu will appear.
- 2 Press **▲▼◀▶** to select and adjust your settings:
 - **[Auto Adjust]**: Automatic adjustment to synchronise your TV with the PC resolution so that your programs are fully displayed on screen.
 - **[H.Position]**: Adjusts the horizontal position.
 - **[V.Position]**: Adjusts the vertical position.

- **[Phase]**: Adjusts the phase frequency of VGA signals.
- **[Clock]**: Adjusts the clock frequency of VGA signals.



Tip

- The VGA menu can only be viewed when the PC is connected.

Play multimedia files from USB device

If you have photos, music or video files on a USB storage device, you can play the files on TV.

Supported video formats on the USB:

- Supported storage device: USB (only FAT or FAT 32 USB storage devices are supported.)
- Compatible multimedia file formats:
 - Image: JPEG
 - Audio: MP3
 - Video: MPEG 2/MPEG 4 , H.264
 - Document: TXT



Caution

- TP Vision is not responsible if the USB storage device is not supported, nor is it responsible for damage or loss of data in the device.

View photos and play audio and video files

- 1 Switch on the TV.
- 2 Connect your USB storage device to the USB slot on the side of the TV.
- 3 Press **⬆️ (Home)**.
- 4 Select **[USB]** and press **OK**.
 - ↳ USB browser opens.

View photos

- 1 From the USB browser, select **[Photo]** and press **OK**.
- 2 Select a photo or folder and press **OK**. The photo will be enlarged to fit the entire screen.
 - Press **CH-** or **CH+** to view previous / next photo.

Start a slide show

- 1 Select a photo or folder and press **OK**. The photo will be enlarged to fit the entire screen.
 - ↳ Start slide show with the selected photos.
- 2 Control the photo slide show using the following buttons:
 - **▶** or **⏸** : Play or Pause
 - **CH-** or **CH+** : View previous / next photo.

Change slide show settings

To start a slide show, press **⬆️ (Home)**, select one of the following options and press **OK**.

- **[Pause / Play]**: Starts / stops the photo slide show.
- **[Repeat]**: Sets the play mode.
- **[Shuffle]**: Displays the slides in sequence or randomly.
- **[Duration]**: Sets the duration of the slide show.
- **[Effect]**: Sets the special effects during the change of photos.
- **[Show Info]**: Shows the name, resolution, file size, date and time of photos.

Listen to music

- 1 From the USB browser, select **[Music]** and press **OK**.
- 2 Select a music track or album and press **OK** to play.

Change music settings

To play music, press **⬆️ (Home)**, select one of the following options and press **OK**.

- **[Pause / Play]**: Starts / stops playing the music.
- **[Repeat]**: Sets the play mode.
- **[Shuffle]**: Displays the music tracks in sequence or randomly.
- **[Show Info]**: Shows information like track title, artiste, size etc.
- **[Show / Hide Spectrum]**: Shows or hides the audio frequency of the track.
- **[Smart Sound]**: Sets the play mode of the sound.
- **[Lyric Option]**: Turn on the lyrics feature and its encoding format (only when the lyrics are available).
- **[Audio Only]**: Turn the screen off to save energy (tap on any key to restore screen).

Watch videos

- 1 From the USB browser, select **[Movie]** and press **OK**.
- 2 Press **OK** to play the video.
- 3 Control the movie using the following buttons:
 - **▶** or **⏸** : Play or Pause
 - **⏮**/**⏭** : Forward or backward search.

Change video settings

To play video, press **⬆️ (Home)**, select one of the following options and press **OK**.

- **[Pause / Play]**: Starts / stops playing the video.
 - **[Repeat]**: Sets the play mode of the video.
 - **[Show Info]**: Show information like video title, resolution and size etc.
 - **[Smart Picture]**: Sets the play mode of the picture.
 - **[Screen Mode]**: Sets the aspect ratio of the video playback.
 - **[Subtitle]**: On or Off subtitles. (Available for subtitle supported formats.)
 - **[Audio Track]**: Next audio track.
 - **[3D Setup]***:
 - **[3D Type]**: Select the 3D input mode.
 - **[Left-Right Swap]**: Sets the Left-Right Swap for 3D pictures.
 - **[3D to 2D]**: Select a compatible 3D format to view 2D images.
 - **[3D Scene]**: Adjusts the depth of field when converting 2D images in 3D.
 - **[3D]***: Sets the 3D play mode for videos.
- * Available on PFL4308 series.

View a document

- 1 From the USB browser, select **[Text]** and press **OK**.
- 2 Press **OK** to view document.
- 3 The following buttons control the viewing of documents:
 - **▶** or **⏸** : Play or Pause
 - **⏮**/**⏭** : Forward or backward search.

Adjust settings to view documents

To play documents, press **⬆** (**Home**), select one of the following options and press **OK**.

- **[Pause / Play]:** Starts / stops showing the document.
- **[Repeat]:** Sets the display mode.
- **[Shuffle]:** Displays the documents in sequence or randomly.
 - **[Show Info]:** Shows document name and size.

Remove USB storage devices



Caution

- Please take the following steps when removing USB storage devices to prevent damage to them.

- 1 Leave the USB browser according to the steps in the menu.
- 2 Wait 5 minutes before detaching the USB storage device.

Update TV software

Philips continuously tries to improve its products and we recommend that you update the TV software whenever they are available. Please visit www.philips.com/support to check for the availability of updates.

Reset factory settings

You can restore the factory default picture and sound settings of your TV. Stored channel settings will remain the same.

- 1 Press **⏸** **ADJUST**.
- 2 Press **▲▼◀▶** to select **[Settings] >** **[Reset]**.
- 3 Select **[Confirm]** and press **OK**. To cancel, select **[Cancel]** and press **OK**.

6 Install channels

This section provides instructions on how to re-install and fine-tune channels.

Automatically install channels

You can search and store channels automatically.

- 1 Press **⏸** ADJUST.
- 2 Press **▲▼◀▶** to select [TV] > [Channels] > [Channel Scan].
- 3 Press **OK**.
↳ TV starts auto search for channels.

Update channels

- 1 Press **⏸** ADJUST.
- 2 Press **▲▼◀▶** to select [TV] > [Channels] > [Update Scan].
- 3 Press **OK**.
↳ TV starts to update the channels.

Manually install channels

You can manually search and store analog TV channels.

Search and store new TV channels

- 1 Press **⏸** ADJUST.
- 2 Press **▲▼◀▶** to select [TV] > [Channels] > [Search for Analog Channels] .
↳ The [Search for Analog Channels] menu appears
- 3 Select [Start/ End Frequency(Mhz)] and enter **the three-digit channel frequency** directly using the number buttons.
- 4 Select [Start Search] and press **OK**.
- 5 Press **⏪** (Home) to exit.

Skip a channel

- 1 Press **⏸** ADJUST.
- 2 Press **▲▼◀▶** to select [TV] > [Channels] > [Channel Edit].
↳ The [Channel Edit] menu will appear.
- 3 Press **▲▼** to select the channel **you want to skip** and press **OK**. Select [Skip] and press **◀▶** to adjust.
- 4 To confirm, select [Save] and press **OK**.
- 5 Repeat the earlier steps to skip more Press **OK** to start the search. channels.



Tip

- Use the number buttons on the remote control to access the skipped channels.
- To view the channels, again please repeat steps 1 to 4 before pressing **OK** to uncheck them.

- 6 Select **[Confirm]** and press **OK** to complete the channel renaming.



Tip

- Maximum 6 characters are allowed for the channel name.

Swap channels

- 1 Press **⏏ ADJUST**.
- 2 Press **▲▼◀▶** to select **[TV] > [Channels] > [Channel Edit]**.
↳ The **[Channel Edit]** menu will appear.
- 3 Press **▲▼** to select the **channel to swap** and press the **red button**.
- 4 Press **▲▼** to select the **channel to swap** and press the **red button** to confirm.

Rename channels

You can rename channels. The channel name appears when you select it.

- 1 Press **⏏ ADJUST**.
- 2 Press **▲▼◀▶** to select **[TV] > [Channels] > [Channel Edit]**.
↳ The **[Channel Edit]** menu will appear.
- 3 Press **▲▼** to select the channel to rename and press the **OK** button.
- 4 Press **▲▼** to select the channel name, press the **OK** button to access the editing interface.
- 5 Press **▲▼◀▶** to select the characters.

7 3D settings

This section is only applicable for PFL4308 series.

You can adjust the 3D settings to obtain the best 3D visual effect. After you have completed the configuration, please put on your 3D glasses to watch 3D programs.

Convert 2D to 3D

- 1 Press **⏏** ADJUST.
- 2 Press **▲▼◀▶** to select **[Settings] > [3D Setup]**.
- 3 Select **[3D Detect] > [Manual]** and press **OK**.
- 4 Select **[3D Type] > [2D-3D]** and press **OK**.
 - **[2D-3D]**: Converts 2D images into 3D images.
 - **[3D View]**: Adjusts the depth of field when converting 2D images to 3D images.

Adjust 3D settings

You can adjust values of the 3D settings used for 3D input signals.

Adjust 3D signal formats

- 1 Press **⏏** ADJUST.
- 2 Press **▲▼◀▶** to select **[Settings] > [3D Setup]**.
- 3 Select **[3D Type]** and press **OK**.
- 4 Select one of the following items and then press **OK**.
 - **[2D-3D]**: Converts 2D images into 3D images.
 - **[3D-2D]**: Converts 3D images into 2D images.
 - **[Side by Side]**: Superimpose 'left-right format' signals to show 3D stereo images.
 - **[Top/Bottom]**: Superimpose 'top-bottom format' signals to show 3D stereo images.
 - **[Frame Packing]**: Superimpose 'frame sequencing format' signals, to show 3D stereo images.

Convert 3D to 2D

Converts 3D images into 2D images.

- 1** Press **⏏** ADJUST.
- 2** Press **▲▼◀▶** to select **[Settings] > [3D Setup]**.
- 3** Select **[3D Type] > [3D-2D]** and press **OK**.
- 4** Select **[3D-2D]** and press **OK**.
- 5** Select the corresponding 3D signal format to view 2D images.



Note

- Adjustment of 3D Type is only possible when 3D Detect is in manual mode.
- 3D depth of field is only applicable when 2D to 3D is enabled.

8 Connect your TV

This section shows you how to connect devices with different connectors.

Note

- You can use different types of connectors to connect a device to your TV.

Back connectors

① HDMI

Digital audio and video input from high-definition digital devices such as Blu-ray players.

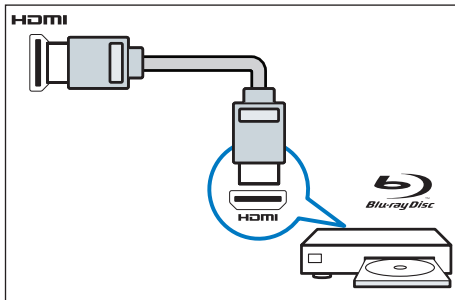

② PC input (VGA and audio)

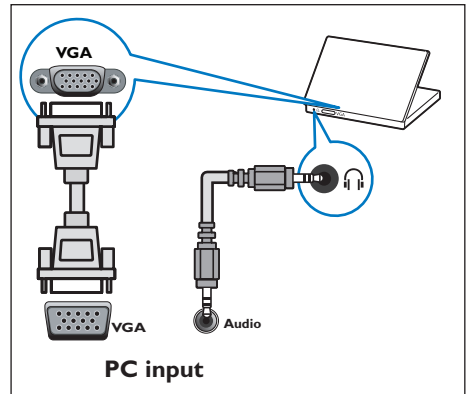

③ Component input/AV input

Audio and video input from analog or digital devices like DVD players or game consoles.

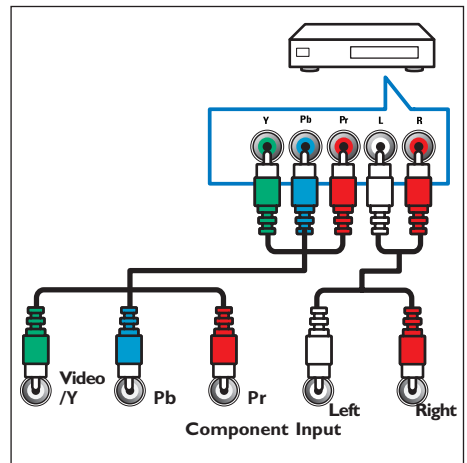

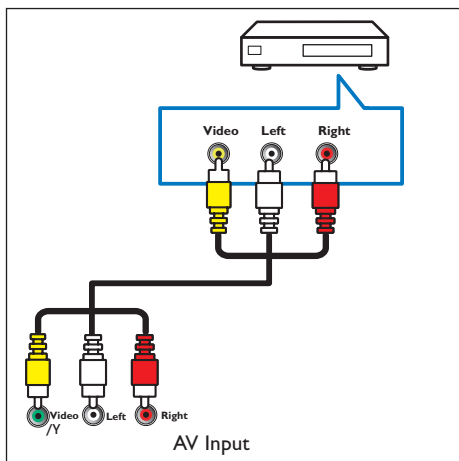

④ Video output

Composite video output from analog devices such as VCRs.

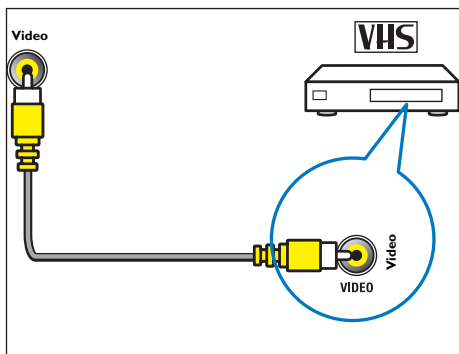

Side connectors

- ① **USB**
Data input from USB storage devices.

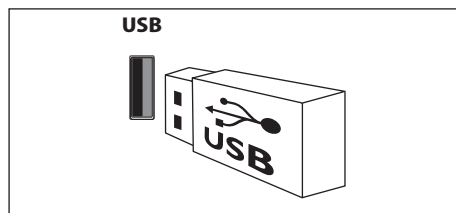

- ② **Antenna / Cable TV**

Signal input from an antenna, cable or satellite.

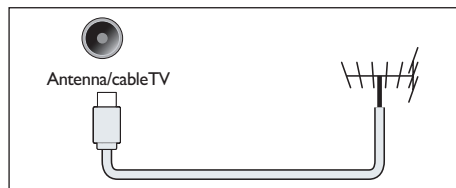

- ③ **SERV. U**

For use by professional service personnel only.

- ④ **Headphone** 

Stereo audio output to headphones or earphones.

Note

- When the headphone is plugged in, the TV speakers will be automatically muted.

Connect a computer

Before you connect a computer to the TV:

- Set the screen refresh rate on your computer to 60Hz.
- Select a supported screen resolution on your computer.

Connect a computer with one of the following connectors:

Note

- Connections via DVI or VGA require an additional audio cable.

- HDMI cable

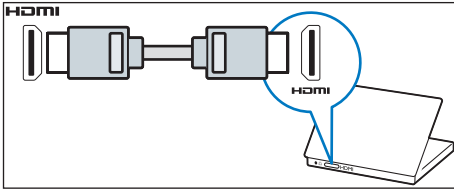

- DVI-HDMI cable

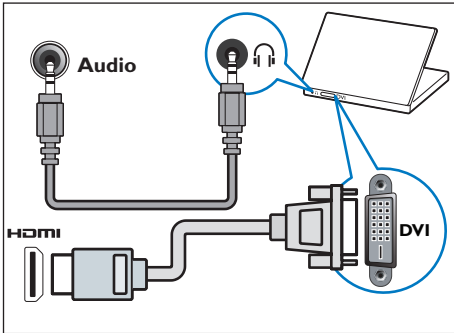

- HDMI cable and HDMI-DVI adapter

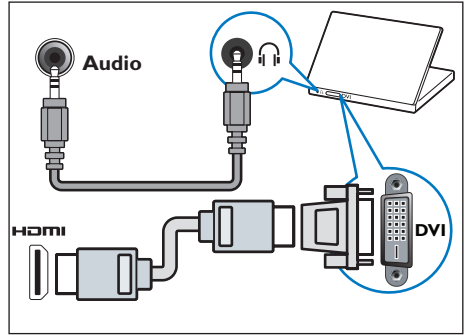

- VGA cable

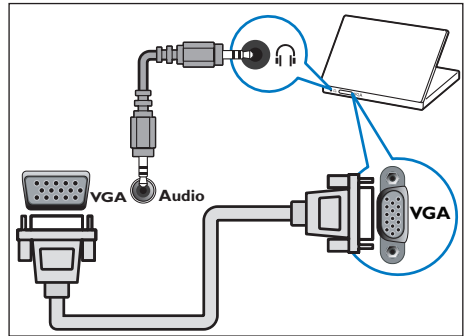

Use Philips EasyLink

Maximising the use of your Philips EasyLink HDMI-CEC-compatible device can enhance its control functions to the maximum level of efficiency. HDMI-CEC-compliant devices that are connected through HDMI connectors can be controlled by the TV's remote control.

To enable Philips EasyLink, you will need to:

- connect two or more HDMI-CEC compatible devices through the HDMI interface.
- confirm that every HDMI-CEC compatible device is functioning properly.
- switch to EasyLink.

Note

- The EasyLink-compliant device must be switched on and selected as the source.
- Philips does not guarantee 100% interoperability with all HDMI CEC devices.

Enable or disable EasyLink

After enabling the HDMI-CEC-compliant device, the TV will automatically turn on and switch to the correct source.

Note

- Do not enable Philips EasyLink if you do not intend to use it.

- 1 Press **⏏** ADJUST.
- 2 Press **▲▼◀▶** to select **[EasyLink]**.
- 3 Select **[Off]** or **[On]** and then press **OK**.

Use One-touch Play

- 1 After enabling EasyLink, press play on your device.
 - ↳ The TV will automatically switch to the correct source.

Use One-touch Standby

- 1 Press **⏏** (Standby-On) on the remote control.
 - ↳ The TV and all connected HDMI devices will switch to standby mode.

9 Product Information

Product information is subject to change without notice. For detailed product information, please visit www.philips.com/support.

Display resolutions

Computer Formats

- Resolution - refresh rate:
 - 640 x 480 - 60Hz
 - 800 x 600 - 60Hz
 - 1024 x 768 - 60Hz
 - 1360 x 768 - 60Hz
 - 1920 x 1080 - 60Hz(not supported for 32"TV)

Video Formats

- Resolution - refresh rate:
 - 480i - 60Hz
 - 480p - 60Hz
 - 576i - 50Hz
 - 576p - 50Hz
 - 720p - 50Hz, 60Hz
 - 1080i - 50Hz, 60Hz
 - 1080p - 50Hz, 60Hz.

Multimedia

- Supported storage device: USB (only FAT or FAT 32 USB storage devices are supported.)
- Compatible multimedia file formats:
 - Image: JPEG
 - Audio: MP3
 - Video: MPEG 2/MPEG 4 , H.264
 - Document:TXT

Sound Power

- 32PFL3008/ 32PFL4008: 10W x 2
- 39PFL3008/ 39PFL4008/ 39PFL4308: 10W x 2
- 42PFL3008/ 42PFL4008/ 42PFL4308: 10W x 2
- 46PFL4008/ 46PFL4308: 10W x 2

Inherent Resolution

- 32PFL3008/ 32PFL4008: 1366 x 768
- 39PFL3008/ 39PFL4008/ 39PFL4308: 1920 x 1080
- 42PFL3008/ 42PFL4008/ 42PFL4308: 1920 x 1080
- 46PFL4008/ 46PFL4308: 1920 x 1080

Tuner/ Reception/ Transmission

- Aerial input: 75ohm coaxial (IEC75)
- TV system: PAL, D/K
- Video playback: NTSC, PAL

Remote Control

- Batteries: 2 x AAA (LR03 type)

Power

- Mains power: 220-240V, 50-60Hz
- Standby power: ≤ 0.5 W
- Ambient temperature: 5 to 45 degrees Celsius
- Ambient temperature: 5 to 40 degrees Celsius (PFL4008/PFL4308)
- Power consumption:
 - PFL3008 series
 - 32PFL3008: 64W
 - 39PFL3008: 87W
 - 42PFL3008: 95W
 - PFL4008 series
 - 32PFL4008: 66W
 - 39PFL4008: 93W
 - 42PFL4008: 101W
 - 46PFL4008: 143W
 - PFL4308 series
 - 39PFL4308: 88W
 - 42PFL4308: 101W
 - 46PFL4308: 143W

Supported TV Mounts

To mount the TV, please purchase a Philips TV mount or any TV mount compliant with the VESA standard. To prevent damage to cables and connectors, be sure to leave a clearance gap of at least 2.2 inches or 5.5cm between the back of the TV to the wall.



Warning

- Please follow all instructions provided with the TV mount. TP Vision Netherlands B.V. bears no responsibility for improper TV mounting that results in accident, injury or damage.

Model no.	Required Pixel Pitch (mm)	Required Mounting Screws
32PFL3008 39PFL3008	100 × 100	4 × M4 (recommended length: 16 mm)
42PFL3008	200 × 200	4 × M4 (recommended length: 16 mm)
32PFL4008	200 × 100	4 × M6 (recommended length: 18 mm)
39PFL4008 39PFL4308	200 × 200	4 × M6 (recommended length: 18 mm)
42PFL4008 46PFL4008 42PFL4308 46PFL4308	400 × 400	4 × M6 (recommended length: 18 mm)

10 Troubleshooting

This section covers common problems and their accompanying solutions.

General issues

The TV cannot be switched on:

- Disconnect the power cable from the power outlet. Wait for one minute before reconnecting it.
- Check that the power cable is securely connected.

The remote control is not working properly:

- Check that the remote control batteries are correctly inserted according to the +/- orientation.
- Replace the remote control batteries if they are flat or weak.
- Clean the remote control and TV sensor lens.

The standby light on the TV is red and blinking:

- Disconnect the power cable from the power outlet. Wait for the TV to cool down before reconnecting the power cable. If the light continues to blink, please contact Philips Customer Care Centre.

You forgot the code to unlock the TV lock feature

- Enter '3448'.

The TV menu is in the wrong language.

- Change the TV menu to your preferred language.

When turning the TV On/Off or to Standby, you hear a creaking sound from the TV chassis:

- No action is required. The creaking sound comes from the normal expansion and contraction of the TV as it cools down and warms up. This does not impact its performance.

Channel issues

Previously installed channels do not appear in the channel list:

- Check that the correct channel list is selected.

Picture issues

The TV is on, but there is no picture:

- Check that the antenna is properly connected to the TV.
- Check that the correct device is selected as the TV source.

There is sound but no picture:

- Check that the picture settings are correctly set.

Poor TV reception from the antenna connection:

- Check that the antenna is properly connected to the TV.
- Loudspeakers, unearthed audio devices, neon lights, high buildings and other large objects can influence reception quality. If possible, try to improve the reception quality by changing the antenna direction or moving devices away from the TV.
- If the reception on one particular channel is poor, please fine tune this channel.

There is poor picture quality from connected devices:

- Check that the devices are connected properly.
- Check that the picture settings are correctly set.

The TV did not save your picture settings:

- Check that the TV location is set to the home setting. This mode offers you the flexibility to change and save settings.

The picture does not fit the screen; it is too big or too small:

- Try using a different picture format.

The picture position is incorrect:

- Picture signals from some devices may not fit the screen correctly. Please check the signal output of the device.

Sound issues

The pictures are showing but sound quality is poor:

Note

- If no audio signal is detected, the TV automatically switches the audio output off - this does not indicate malfunction.

- Check that all cables are properly connected.
- Check that the volume is not set to 0.
- Check that the sound is not muted.
- Check that the sound settings are correctly set.

The pictures are showing but sound comes from one speaker only:

- Verify that sound balance is set to the centre.

HDMI connection issues

There are problems with HDMI devices:

- Please note that HDCP (High-bandwidth Digital Content Protection) support can delay the time taken for a TV to display content from a HDMI device.
- If the TV does not recognise the HDMI device and no picture is displayed, please try switching the signal source to another device before switching it back again.
- If there are intermittent sound disruptions, please check that output settings from the HDMI device are correct.

- If you are using a HDMI to DVI adapter or cable, please check if the audio cable that comes with the product is connected to AUDIO (only for mini jacks).

Computer connection issues

The computer display on the TV is not stable:

- Check that your PC uses the supported resolution and refresh rate.
- Set the TV picture format to unscaled.

Contact us

If you cannot resolve your problem, please refer to the FAQs for this model at www.philips.com/support.

If the problem remains unresolved, please contact your local Philips Customer Service Centre.



Warning

- Do not attempt to repair the TV yourself. This may cause severe injury, irreparable damage to your TV or void your warranty.



Note

- Please make a note of your TV model and serial number before you contact Philips Customer Service Centre. These numbers are printed on the back of the TV and on the packaging.



Environmental Protection Use Period

This logo labelled on the product itself indicates that the Environmental Protection Use Period thereof is 10 years.

The Environmental Protection Use Period of electrical information products refers to the time period during which the toxic and hazardous substances or elements contained within the product will not leak or suddenly spoil, and users of such products will not cause any serious environmental pollution or serious damage to human and property.

During the Environmental Protection Use Period, please use this product according to the instructions given in this user manual.

The Environmental Protection Use Period does not cover consumable parts: the battery.

Suggestive description of the Recycling Administrative Regulations for Waste Electrical and Electronics Products

In order to care and protect the Earth in a better way, please adhere to the national and applicable laws in relation to the recycling management of waste electrical and electronics products when the user no longer needs to use this product, or when it has reached the end of its product life.



© 2013 TPVision Netherlands B.V.

All rights reserved.

Document order number:

Philips and the Philips' shield emblem are registered trademarks of Koninklijke Philips Electronics N.V. and are used under license from Koninklijke Philips Electronics N.V.