

请至以下互联网址注册产品以获得完整的信息服务
www.philips.com/welcome
使用产品前请阅读用户手册并请保留备用！

3600系列LED背光源液晶电视

32PHF3651/T3

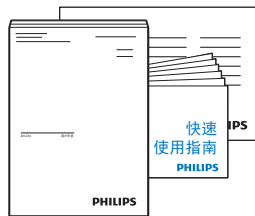
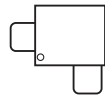
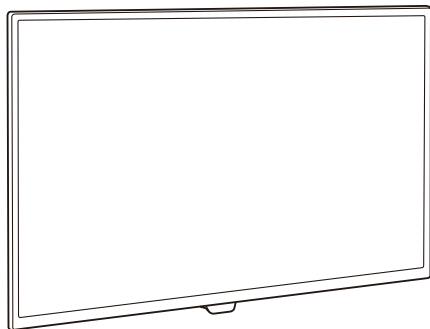

快速 使用指南

PHILIPS

产品外形根据型号不同会有所差异，请以实际机型为准！

您的产品包装箱内物品摆放位置

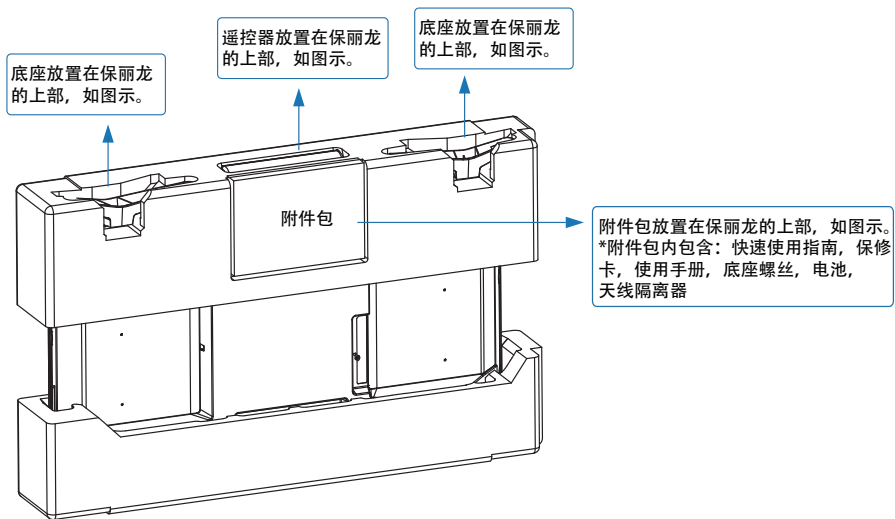

以上图示仅供参考，具体请以实际为准！

目录

您的产品包装箱内物品摆放位置	2
安装底座	4
连接	7
电池安装方式	9
打开电视	10

1

安装底座

1

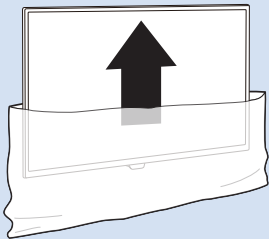

32" 3.78kg



*取出电视机。

2

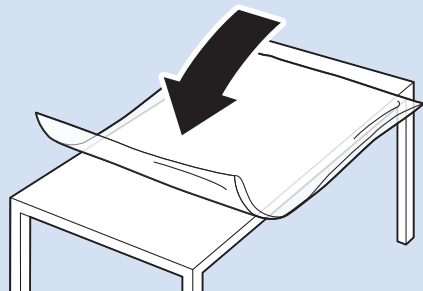

*确保平整台面上无杂物后铺上软布。

3

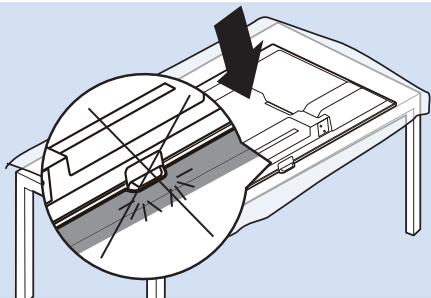

*请将电视机底部边缘靠近台面边缘，将下巴放置于台面外。

4

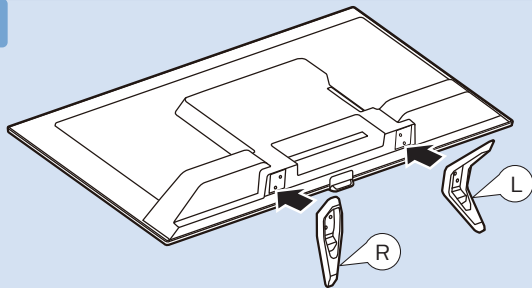

*将底座按照图示对齐放置。

5

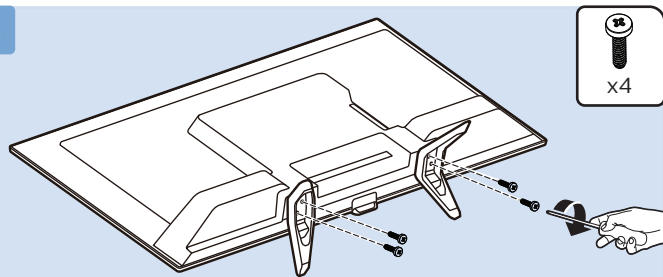

*按照图示将螺丝锁紧。

6

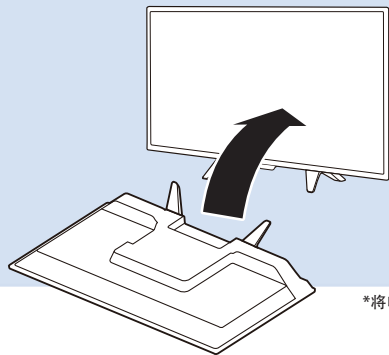

*将电视扶起放好。

VESA (x)
32" 200 M4



(壁挂配件需另外购买)

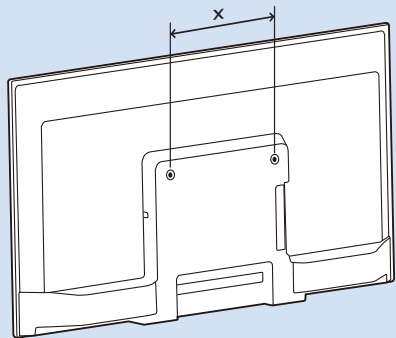

2

连接

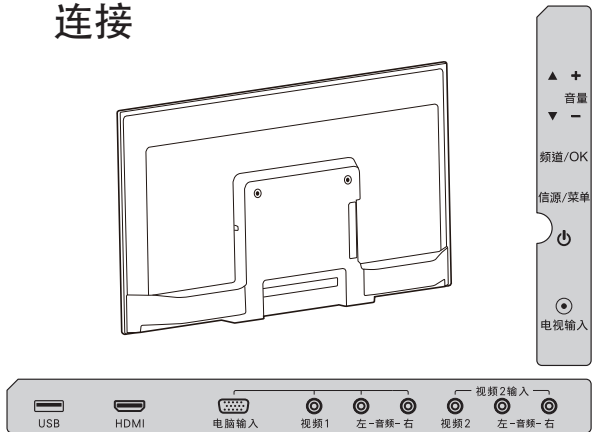

我们随机附送天线隔离器,请在安装电视的同时一并安装上天线隔离器(安装方式如图示)。

请用户在使用前务必确认天线隔离器是否有安装,若为直接接入,电视机的有线网络天线必须与保护接地隔离,否则可能会引起着火等危险。

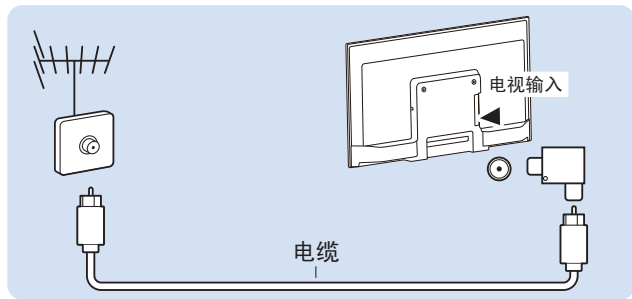
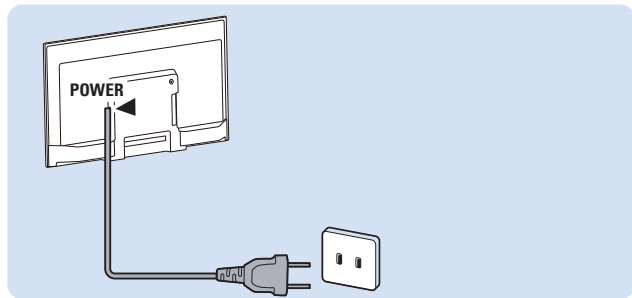

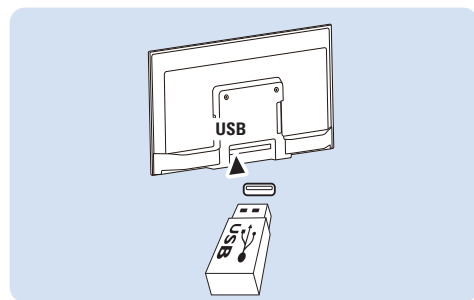
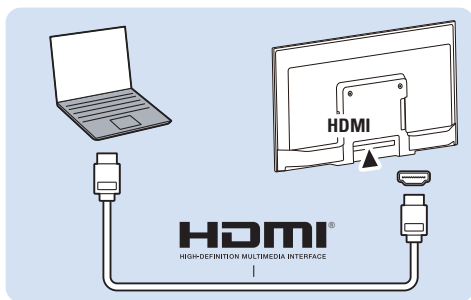
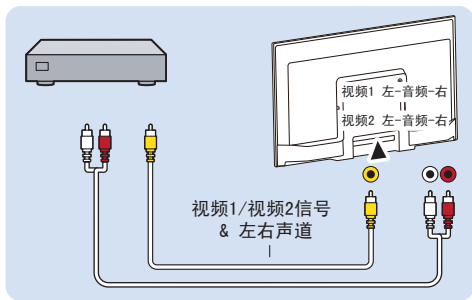
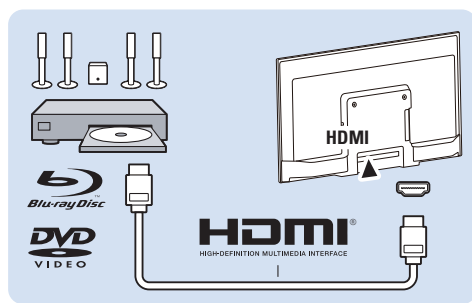
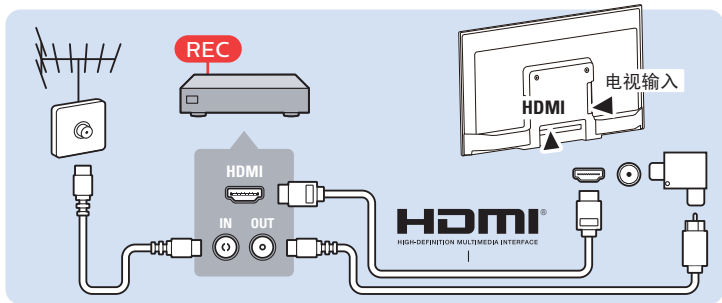

3



电池安装方式

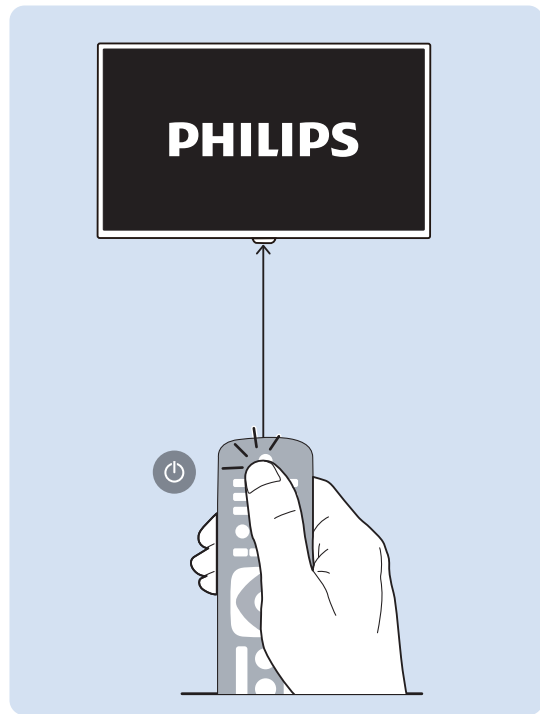
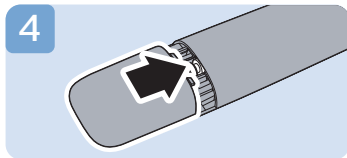
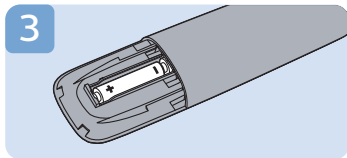
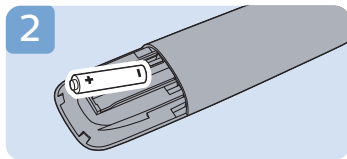
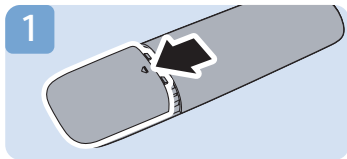

4

打开电视

按下电视侧面的电源开关，打开电视机。

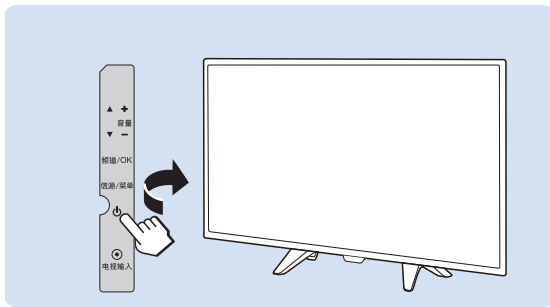

5

?

更多操作信息请参考使用手册与 PHILIPS support 网站。



马上扫码，报装报修，一步搞定，简单三步，加入飞利浦电视俱乐部，享额外延保专属权益！

扫码关注 · 飞你不可 · 注册会员

热线电话：4008 800 008
www.philips.com.cn





所有注册和未注册的商标是其各自所有者的财产。规格如有变更，恕不另行通知。
Philips 和 Philips 盾牌图形是皇家飞利浦有限公司的注册商标，其使用需遵循皇家飞利浦有限公司的许可。

出版日期：2016年6月