

Register your products and get support at  
[www.philips.com/welcome](http://www.philips.com/welcome)

5000 Series

# Quick start guide

**PHILIPS**



English

Before using your product, read all accompanying safety information.

(The relevant parameters of instructions are variable, without prior notice, if there is any discrepancy, please in accordance with actual object.)



English

What's in the box

(40")

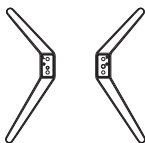
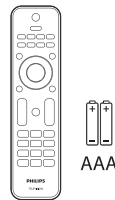
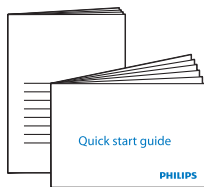
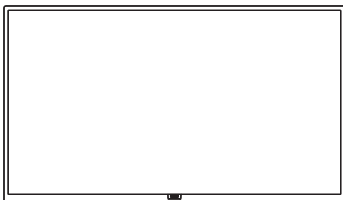

(4 pcs)

1

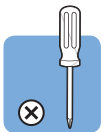

English

Mount the stand

(40°)

1

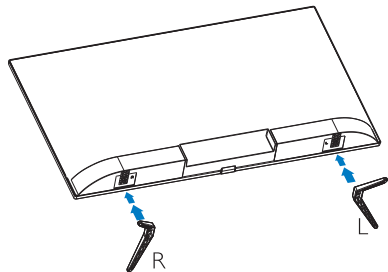
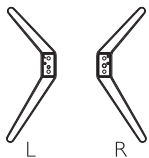

2

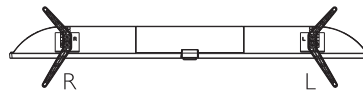

3

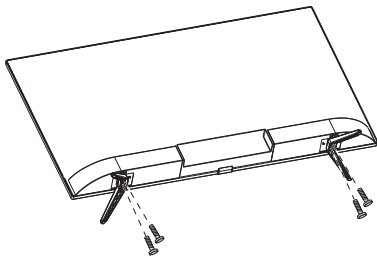

# 2

English

Connect

(40")

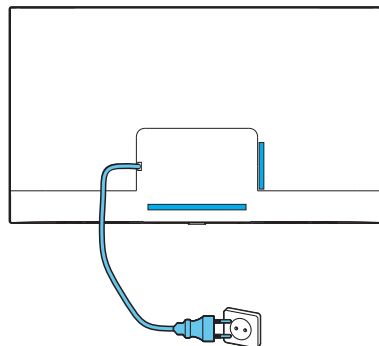

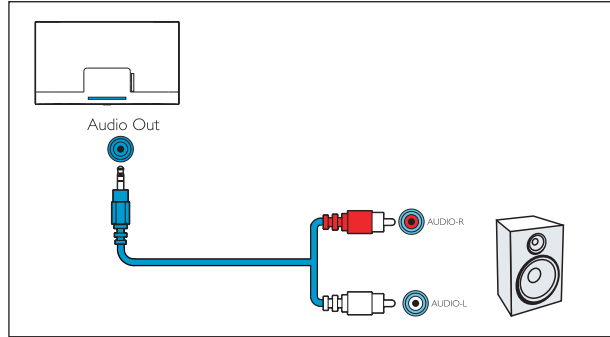
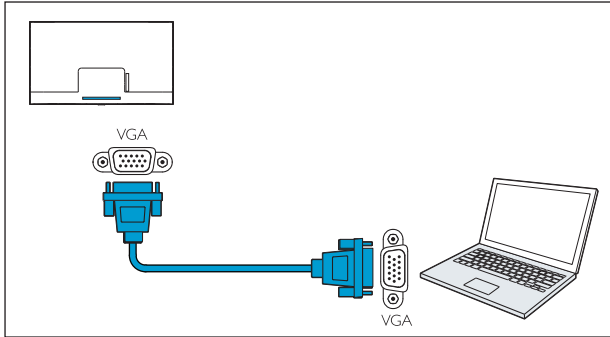
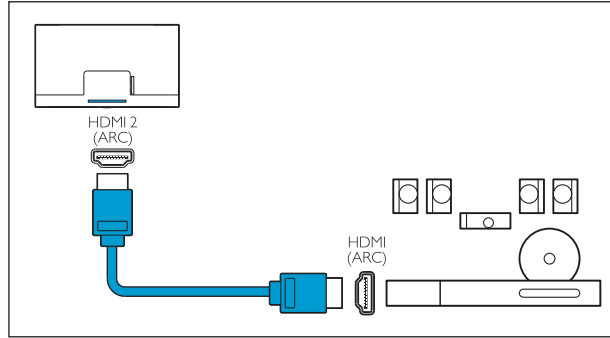
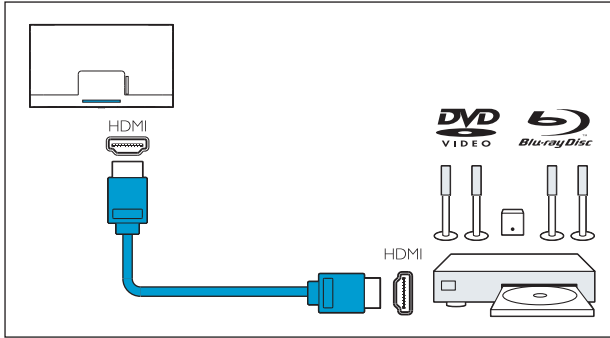

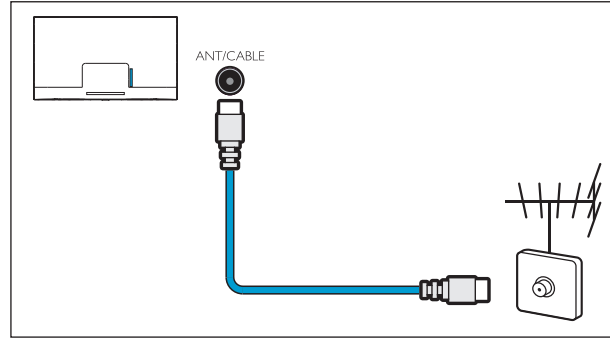
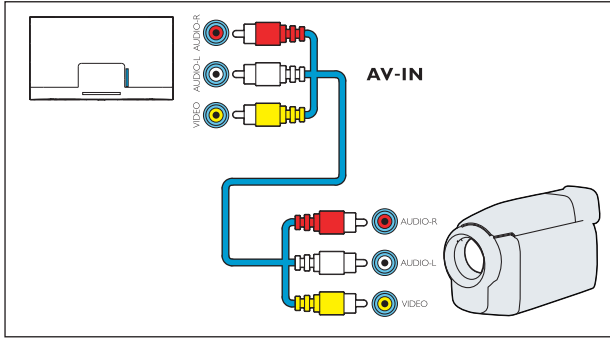

3

English

Insert batteries

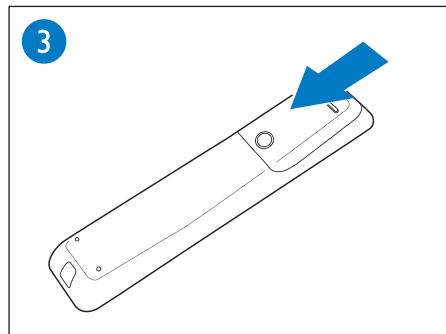
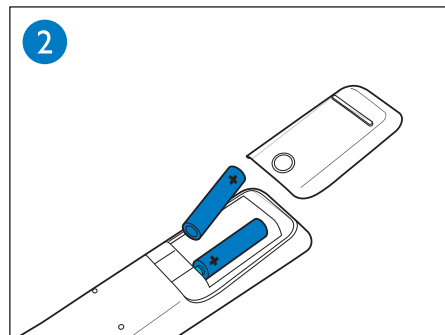
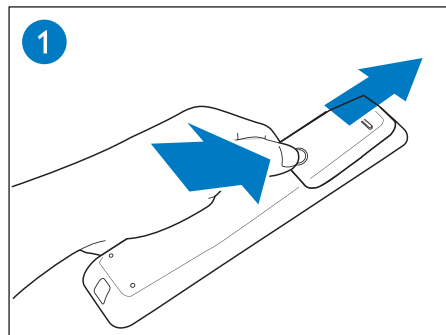





English

To wall mount, purchase a suitable bracket.

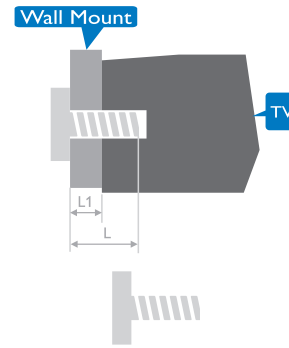
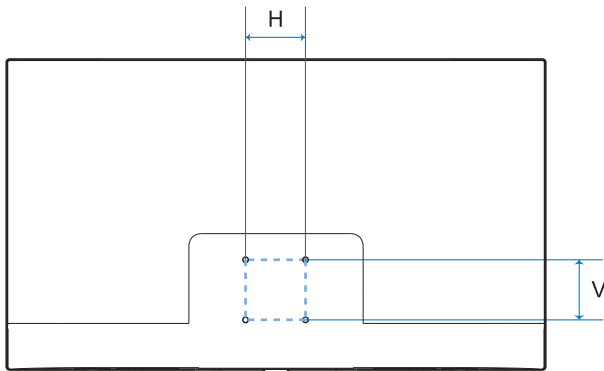

L1=Wall Mount thickness

TV	H	V	Required Mounting Screws (Recommended screw length)
100 cm / 40"	100 mm	100 mm	4 x M4 (L= 6+L1)mm

4

English Press the  key on the back of the TV or on the remote control to turn on the TV.

(40")

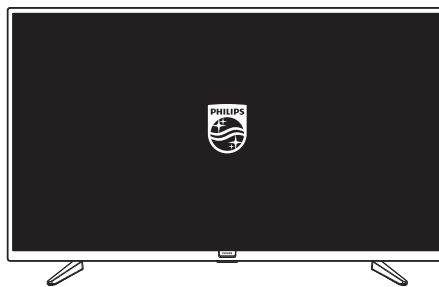
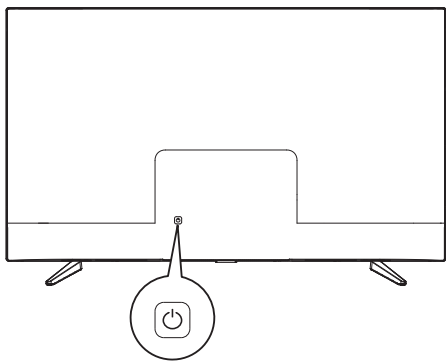



English

Please refer to the User's Manual and the Philips support website for more operating instructions.





All registered and unregistered trademarks are property of their respective owners. Specifications are subject to change without notice. Philips and the Philips' shield emblem are trademarks of Koninklijke Philips N.V. and are used under license from Koninklijke Philips N.V.

2018 ©TPVision Europe B.V. All rights reserved.  
philips.com

